



This is a digital copy of a book that was preserved for generations on library shelves before it was carefully scanned by Google as part of a project to make the world's books discoverable online.

It has survived long enough for the copyright to expire and the book to enter the public domain. A public domain book is one that was never subject to copyright or whose legal copyright term has expired. Whether a book is in the public domain may vary country to country. Public domain books are our gateways to the past, representing a wealth of history, culture and knowledge that's often difficult to discover.

Marks, notations and other marginalia present in the original volume will appear in this file - a reminder of this book's long journey from the publisher to a library and finally to you.

Usage guidelines

Google is proud to partner with libraries to digitize public domain materials and make them widely accessible. Public domain books belong to the public and we are merely their custodians. Nevertheless, this work is expensive, so in order to keep providing this resource, we have taken steps to prevent abuse by commercial parties, including placing technical restrictions on automated querying.

We also ask that you:

- + *Make non-commercial use of the files* We designed Google Book Search for use by individuals, and we request that you use these files for personal, non-commercial purposes.
- + *Refrain from automated querying* Do not send automated queries of any sort to Google's system: If you are conducting research on machine translation, optical character recognition or other areas where access to a large amount of text is helpful, please contact us. We encourage the use of public domain materials for these purposes and may be able to help.
- + *Maintain attribution* The Google "watermark" you see on each file is essential for informing people about this project and helping them find additional materials through Google Book Search. Please do not remove it.
- + *Keep it legal* Whatever your use, remember that you are responsible for ensuring that what you are doing is legal. Do not assume that just because we believe a book is in the public domain for users in the United States, that the work is also in the public domain for users in other countries. Whether a book is still in copyright varies from country to country, and we can't offer guidance on whether any specific use of any specific book is allowed. Please do not assume that a book's appearance in Google Book Search means it can be used in any manner anywhere in the world. Copyright infringement liability can be quite severe.

About Google Book Search

Google's mission is to organize the world's information and to make it universally accessible and useful. Google Book Search helps readers discover the world's books while helping authors and publishers reach new audiences. You can search through the full text of this book on the web at <http://books.google.com/>

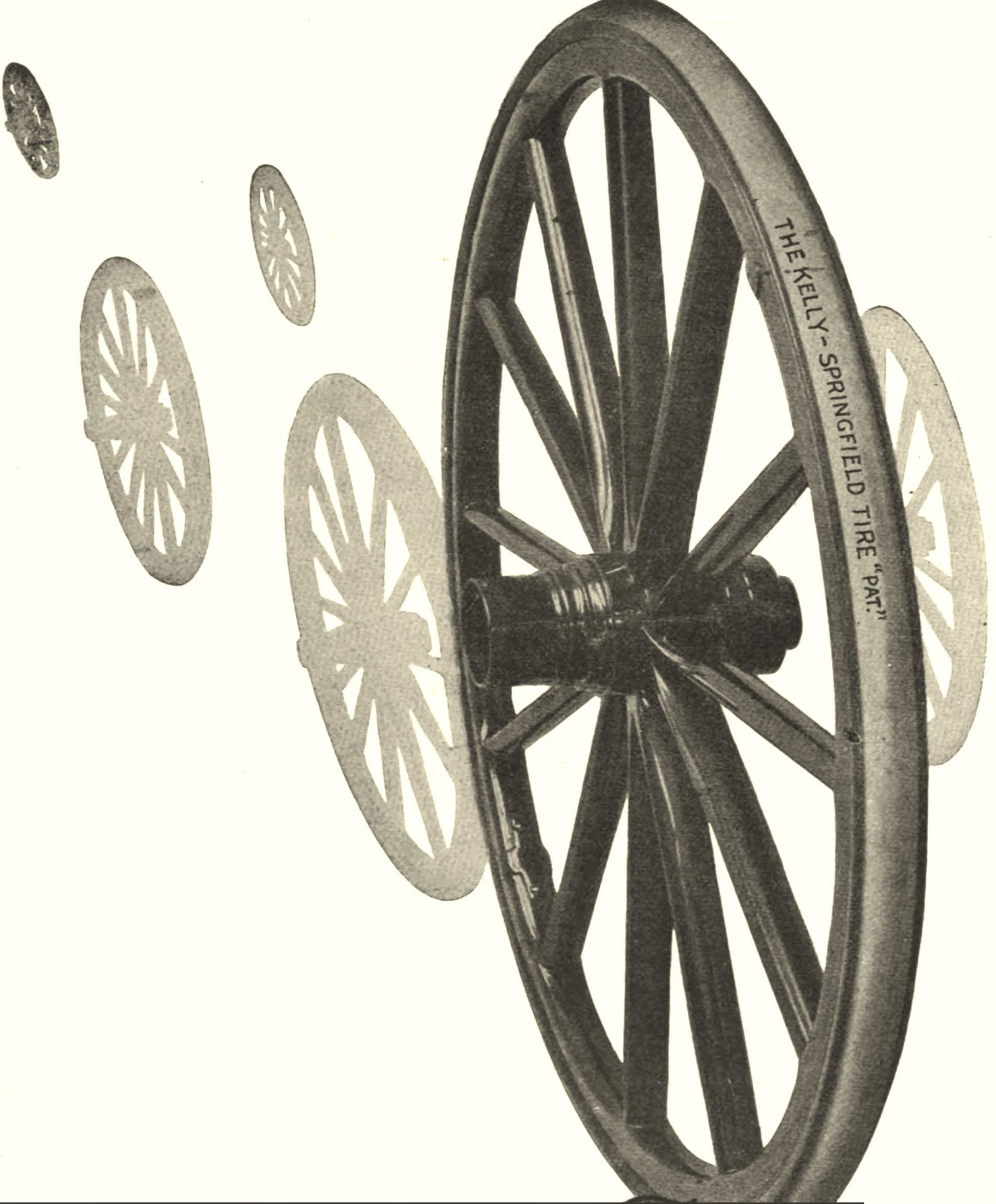

*The automotive
manufacturer*

EBODY
is until
er know
he

Kelly-Springfield

PROPERTY OF
*University of
Michigan
Libraries*
1817

ARTES SCIENTIA VERITAS

The Hub

Vol. LII.

APRIL, 1910.

No. 1.

AUTOMOBILES
CARRIAGES
MOTOR TRUCKS
WAGONS

TRADE NEWS PUBLISHING COMPANY
24-26 Murray St., New York, N. Y.

Hoopes Bro. & Darlington Inc.

West Chester, Penna., U. S. A.

SARVEN
STAR or KENNY
Sweet Concealed Band
WOOD HUB
WARNER

HEAVY and LIGHT
for
CARRIAGES
WAGONS and
TRUCKS

IF YOU WANT THE BEST TRY OURS

The Output of Complete FRONT AND REAR AUTOMOBILE AXLES of this Plant Exceeds the Capacity of All Competition Combined.

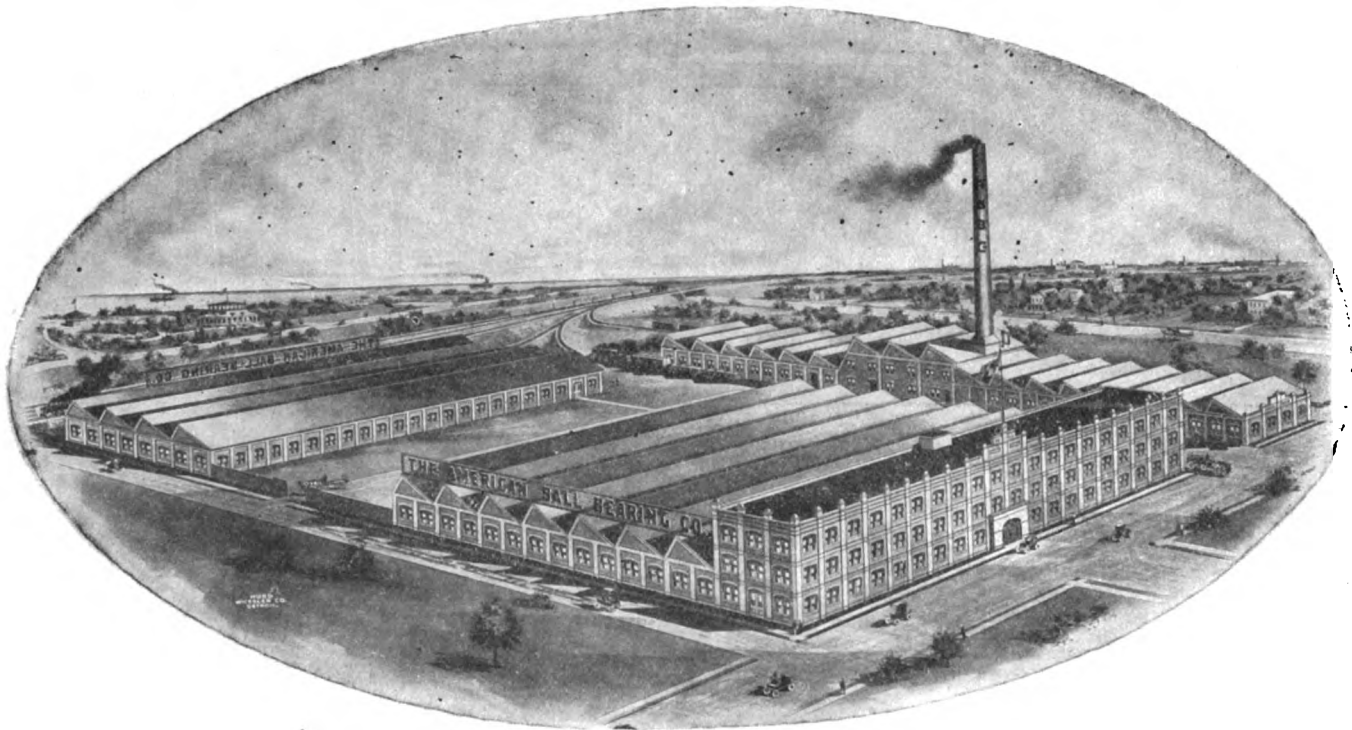

The American Ball-Bearing Co.,

L. S. & M. S. R'y and Edgewater Park.

CLEVELAND, OHIO, U. S. A.



CRANE & MACMAHON,
(INCORPORATED)

8-10 Bridge St., NEW YORK CITY, U. S. A.

Sole Manufacturers and Exporters of the

HICKORY NUT,  **ACORN,**  **and STAR**  **BRANDS OF**

Carriage, Wagon and Automobile Wood Stock

FACTORIES:

ST. MARYS, OHIO. RICHMOND, VA.

For Export Prices apply to the New York office.

April, 1910.]

The Hub

This Advertisement is Published for the Protection of the Automobile Public

United States Patent No. 549,160, granted November 5, 1895, has been held by Judge Hough, of the United States Circuit Court for the Southern District of New York, to be valid and to cover the modern gasoline automobile.

This Patent is Known to the Public as the "Selden Patent"



Official License Plate

LICENSES have been granted to manufacturers of gasoline automobiles, the names of which are given below. This list includes almost every prominent manufacturer of automobiles in this country, as a perusal of the names will clearly indicate. Manufacturers whose cars are not in this list are infringers.

SUITS may be brought under this patent for infringements by manufacturers, by dealers, or by users of pleasure or commercial gasoline automobiles, and it is the intention of the owners of this patent to protect the exclusive rights secured by it to those who have become licensees, by commencing suits against infringers of it.

THE Selden Patent is a basic patent. It is recognized by nearly all reputable automobile manufacturers, and its basic character, as well as its validity, has been established by the

Court, and therefore the manufacture, sale or use of any pleasure or commercial gasoline automobile by any person not licensed under this patent is unlawful and an infringement of this patent.

THE Association of Licensed Automobile Manufacturers stands for much more than merely the recognition of the Selden Patent. Its members, individually and through their combined efforts in the Association, are chiefly responsible for the development of the automobile to its present perfect state.

WHILE extending protection to a long list of manufacturers, it has not been the policy of those who control the patent to extend protection to new or untried or doubtful products.

THIS announcement is made so that buyers of automobiles may know the facts and be governed accordingly.

Read the list of cars licensed under Selden Patent:

AMERICAN MAKES

| | | | | |
|-----------|-----------------|-------------------|-----------------------|--------------------|
| Acme | E-M-F. | Lambert | National | Regal |
| Alco | Flanders | Locomobile | Oakland | Rapid (com'l cars) |
| American | Ewing (taxicab) | Lozier | Oldsmobile | Reliance (truck) |
| Amplex | Fuller | Marion | Overland | Reo |
| Apperson | Glide | Mack (com'l cars) | Packard | Royal Tourist |
| Autocar | Grabowsky | Matheson | Palmer-Singer | Sampson (truck) |
| Brush | Franklin | Maxwell | Peerless | Selden |
| Buick | Haynes | McIntyre | Pierce-Arrow | Simplex |
| Cadillac | Hewitt (truck) | Mercer | Pierce-Racine | Stearns |
| Cartercar | Everitt | Mitchell | Pope-Hartford | Stevens-Duryea |
| Chalmers | Hudson | Moline | Premier | Stoddard-Dayton |
| Columbia | Hupmobile | Moon | Pullman | Studebaker-Garford |
| Corbin | Jackson | Mora | Rainier | Thomas |
| Dorris | Knox | Marmon | Randolph (com'l cars) | White |
| Elmore | | | | Winton |

IMPORTED MAKES

Brasier Delaunay-Belleville Lancia

ASSOCIATION OF LICENSED AUTOMOBILE MANUFACTURERS

No. 7 East 42nd Street, New York, N. Y.

TRANSA
TL
12
A938

JOHN W. MASURY & SON

Originators of

Superfine Coach and Automobile Colors

Acknowledged the Standard for Fifty Years

AND MANUFACTURERS OF

Fine Carriage and Automobile Varnishes

New York, Chicago, Minneapolis, Kansas City

WILLEY'S COLORS

The RECOGNIZED STANDARD



C. A. WILLEY CO.

COLORS GRINDERS

and Manufacturers of Specialties in

CARRIAGE, AUTOMOBILE AND CAR

PAINTS

COLORS, VARNISHES, ETC.

HUNTER'S POINT, NEW YORK CITY

THE STANDARD Auto Door Locks FOR NINETEEN TEN

No. 999 Security Hook Lock
for Touring Cars.

No. 25 Security Hook Lock with
complete lever control
for Touring Cars.

No. 39 Rotary Lever Lock for
Limousines and other
closed vehicles.

Test them out NOW for the
coming season. : : : : :

English & Mersick Co.

New Haven, Conn.

3/4

of the MOTOR CARS Exhibited at the

Chicago Automobile Show, Feb. 5-12, 1910

Were Finished With

Trade **VALENTINE** Mark
VARNISHES

THERE WERE 319 CARS EXHIBITED
THERE WERE 237 CARS VALENTINED

WHICH IS **75%** OF ALL

VALENTINE & COMPANY

New York Boston Chicago Toronto Paris Amsterdam

83 Years' Experience in Every Can



Edward Smith & Co.

CARRIAGE VARNISHES

Everything from the
Bare Wood to the Finishing Coat.

CHICAGO

NEW YORK

VEHICLES AND GEARS IN THE WHITE



PREMIER
SIDE SPRING GEAR

We manufacture a full line of Carriage and Wagon bodies in the white; also Limousine, Taxicab, Touring Car and Roadster Bodies for automobiles in metal. Fifty styles of gears for Carriages and Wagons; also seats, trimmings and tops of all kinds.

Write to us for particulars.

Schubert Bros. Gear Company

ONEIDA, NEW YORK.

RUB ————— RUB ————— RUB

THAT'S THE EXPERIENCE SOME PAINTERS HAVE WITH A POOR RUBBING VARNISH. THEY RUB TILL THEIR HEART ACHES ONLY TO HAVE THE VARNISH SWEAT, OR ROLL UP UNDER THE PAD

XX Diamond Rubbing and Hard and Quick Drying Rubbing "A"

DRY HARD TO RUB IN TWO DAYS, WITHOUT SWEATING, ARE TOUGH AND THE BEST FOUNDATION FOR FINISHING COATS.

MADE BY **MOLLER & SCHUMANN CO.**

MARCY AND FLUSHING AVES.,

BROOKLYN, N. Y.

Please mention "The Hub" when you write.

1910 IMPROVEMENTS IN SWINEHART TIRES

MEAN MORE MILEAGE, LESS EXPENSE, NO DELAYS, DOLLARS SAVED

CONSIDER! Mr. Manufacturer, the advantages of our line before leaping into the uncertainty of 1910 season with an old-fashioned, inefficient, unimproved, inconvenient tire equipment.

CONSIDER! Mr. Manufacturer, that truck owners in general are no longer buying tires because they are cheap.

CONSIDER! Mr. Manufacturer, that more Swinehart tires are used in New York and Chicago (the great commercial car fields) than any other make, because they give from 20 per cent to 50 per cent more service, and are more convenient to apply.

CONSIDER! Mr. Manufacturer, every time your customers are forced to lay up their cars for repairs to tires or renewals, it costs them from \$10 to \$50 per day, and consider that Swinehart quick detachable rims eliminate all such delays.

SAVE YOUR CUSTOMERS MONEY AND IMPROVE THE REPUTATION OF YOUR CAR BY USING SWINEHART TIRES

FLANGE RIM FOR WOOD WHEELS

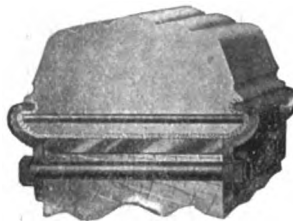

The success of our quick detachable rims during past seasons has demonstrated that truck owners appreciate this feature.

Our clincher tires with improved quick detachable flange rims make it possible for an amateur to change tires in thirty minutes. The nuts on one side are simply taken off, one flange removed, old tire slipped off, new one put on and flange replaced. No tools other than wrench and a few bars required.

QUICK DETACHABLE RIM FOR STEEL WHEELS

The rim shown at left has revolutionized the truck tire business and demoralized competitors. It has placed the truck tire manufacture on the same high plane of perfection as tires for pleasure cars. This rim is furnished for all steel wheels.

Not only have our tires and rims been improved constantly, but facilities improved and capacity enlarged in order to meet the constantly increasing demand for our product.

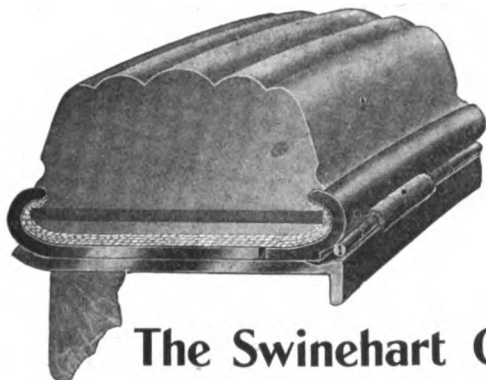

MOTOR BUGGY SPECIAL

Expressly designed for motor-driven cars—not a tire for horse-drawn vehicles. Wide tread gives increased traction. Large size, beaded tread and concave sides add resiliency and durability. Made endless, no joints, easily applied by anyone.

The Swinehart Clincher Tire and Rubber Company.
Akron, Ohio

NEW YORK, 875 7TH AVENUE
DETROIT
850 Woodward Avenue

ST. LOUIS
2109 N. 9th

CHICAGO, 1720 MICHIGAN AVENUE
SAN FRANCISCO
503 Van Ness Avenue
INDIANAPOLIS, IND.
809 Mass. Avenue

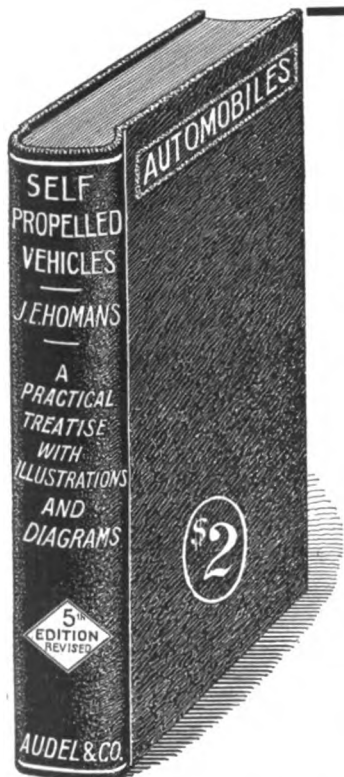

"Self-Propelled Vehicles"

Fifth Edition, Revised.

A practical treatise on the theory, construction, operation, care and management of all kinds of Automobiles.

By

JAMES E. HOMANS, A.M.

Contains 608 pages and upwards of 500 illustrations and diagrams, giving the essential details of construction and many important points on the successful operation of the various types of motor carriages driven by steam, gasoline and electricity.

This work is now the accepted standard, explaining the principles of construction and operation in a clear and helpful way. This book will be sent postpaid to any address in the United States, Mexico or Canada upon receipt of \$2.00.

Address

TRADE NEWS PUBLISHING COMPANY

24 Murray Street, New York

FOR SALE

MANUFACTURING PLANT

A complete and fully equipped plant for the manufacture of

Wheels, Spokes, Rims, Etc.

with a well established business and plenty of orders and material on hand to continue the business uninterrupted. Persons interested are requested to call or address

THE HUB,

24-26 Murray Street. New York City

Goodrich Solid Rubber Tires

Internal Wire Side-Wire Tires
Carriage Tires for Heavy Carriages

These products represent fifteen years of consistent development, and co-operation with customers. They have been distinguished always by the

Mark of Quality



Copies of the 1910 Catalogue will be gladly sent on request.

The B. F. Goodrich Company
Akron, Ohio

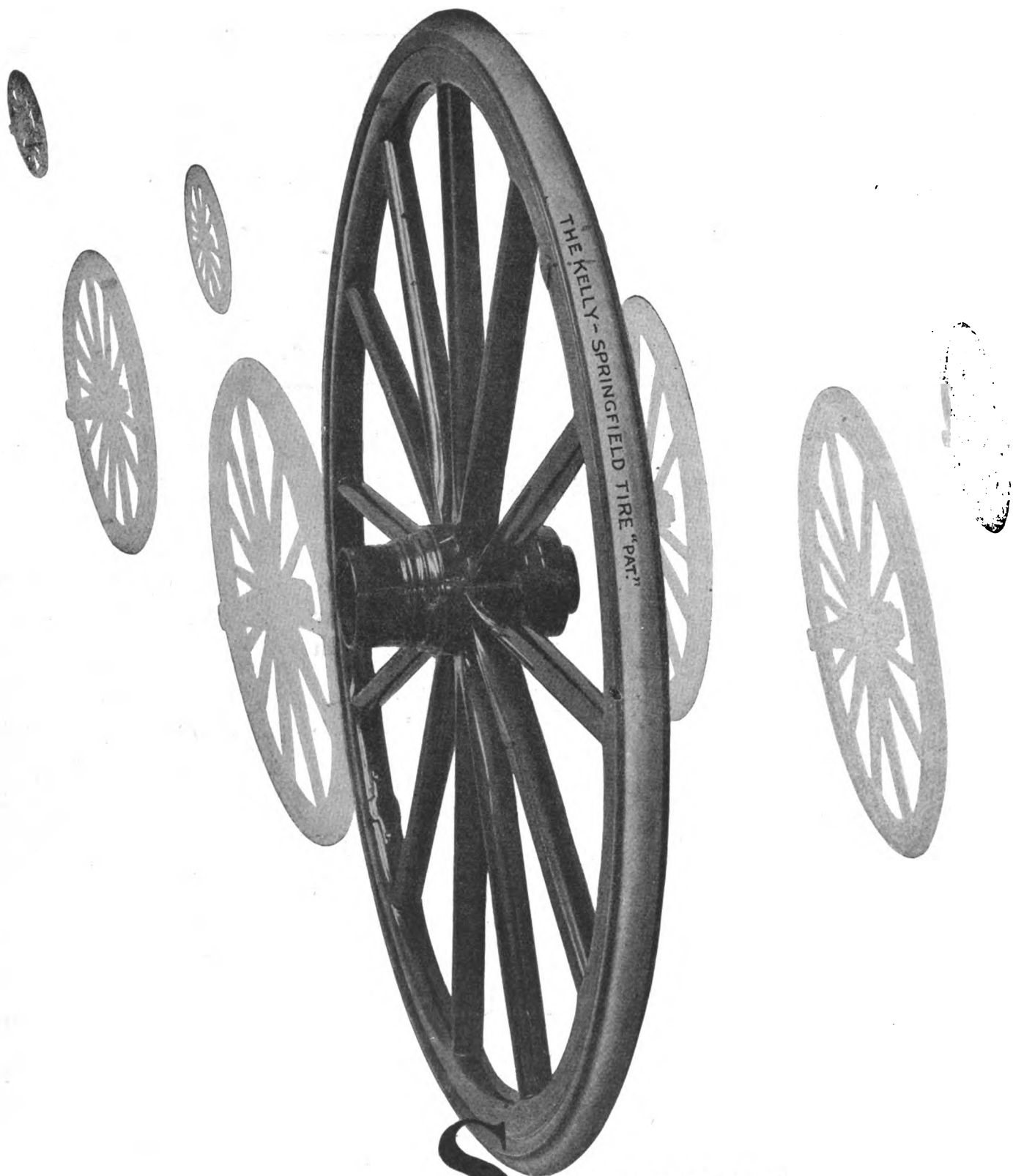

SOMEbody said that you never know how good a thing is until you see the imitation. WE say you never know how bad its imitations are until you see the **Kelly-Springfield Tire**

The

Hub

Copyright, 1910, by the Trade News Publishing Co. of New York.

Entered in the New York Post Office as Second-class Matter.

Vol. LII.

APRIL, 1910.

No. 1.

THE TRADE NEWS PUBLISHING CO. OF N. Y. Publishers of THE HUB

J. H. WRIGHT, *President.* G. A. TANNER, *Secretary and Treasurer.*
24-26 MURRAY STREET, NEW YORK.

JACOB H. KLEIN, *Technical Editor.*

Other Publications of Trade News Publishing Co.:

HARNESS (monthly)per year, \$1.00
AMERICAN HARNESS AND SADDLERY
DIRECTORY (annual)per copy, \$4.00

THE HUB is published monthly in the interest of employers and workmen connected with the manufacture of Carriages, Wagons, Sleighs, Automobiles and the Accessory trades, and also in the interest of Dealers.

Subscription price for the United States, Mexico, Cuba, Porto Rico, Guam the Philippines, and the Hawaiian Islands, \$2.00, Canada, \$2.50, payable strictly in advance. Single copies, 25 cents. Remittances at risk of subscriber, unless by registered letter, or by draft, check, express or post-office order, payable to the order of TRADE NEWS PUBLISHING Co.

For advertising rates, apply to the Publishers. Advertisements must be acceptable in every respect. Copy for new advertisements must be received by the 25th of the preceding month, and requests to alter or discontinue advertisements must be received before the 12th day of the preceding month to insure attention in the following number. All communications must be accompanied by the full name and address of writer.

FOREIGN REPRESENTATIVES:

FRANCE.—L. Dupont, publisher of *Le Guide des Carrossiers*, 78 Rue Boissiere, Paris. Subscription price, 15 francs, postpaid.

GERMANY.—Gustave Miesen, Bohn a Rh. Subscription price, 12 marks, postpaid.

ENGLAND.—Thomas Mattison, "Floriana," Hillside Avenue, Bitterne Park, Southampton. Subscription price, 12 shillings, postpaid.

Parts Makers.

It is interesting to note that the automobile maker on the quantity basis lays much stress on his splendid factory organization by which it becomes possible to produce the needed parts not only cheaper but so much better than they can be assembled by gathering them from special sources. It is said the expense is much reduced, also. No doubt the claim is builded upon a rock foundation of fact, but there is a more important point of view. Many minds devoted to specialization are certainly likely to think out refinements of parts with more success in results than the busy maker, who has a vast establishment to think about, especially when all hands must be more or less, generally more, bound by the routine of manufacture.

Even the buyer and user of the machines is wise to this proposition, as is shown by the news of the day, in which it is stated that a company of one hundred men of wealth has been incorporated to build one hundred automobiles—one for each—the sole actuating reason being to select from any and every source the particular part of extreme excellence and practicability in an automobile, and assemble it in this auto de luxe, regardless of the expense of the undertaking. The point aimed at is perfection so far as the present state of the art will afford it.

Very good. It is along these very same lines that the

parts maker of the trade is progressing. His activities are confined to specialization. Any part, be it of engine, frame, or any subsidiary bit of the mechanism, is the better for his thought, attention and concentration. He will gild the refined gold of previous effort, and make something better than the large complete organization will think it out. Evidences of such evolution are already well to the front. The parts makers' exhibits at shows is the section in which is to be found the real advance in the business.

The evolution is proceeding along exactly the same lines as could have been noted in the horse-drawn vehicle industry. From that quarter sprung all the advance in the art of vehicle building; it will be the same in the motor vehicle trade.

The parts maker with his plain or patented improvements, due to his concentration of thought and experiment on a single part, will be the advance agent of progress to whom the builder must look for what is best to use in assembling a perfect vehicle.

It is no disparagement to the brains and ability of the large manufacturer that this will be so, it is just the natural outcome of things. No carriage builder ever forged an axle having the perfection of parts that it has coming from the man who gives axles his undivided thought. The carriage builder learned this truth, then gave up trying. He bought cheaper and better than he could forge for himself. This is an individual instance. Multiply it along the line.

We believe the assembled parts of the auto are crude to-day compared to what they will be in the not distant future, and the progress will be solely due to the parts maker.

Solid Wheels.

The high cost of rubber, and the tendency it seems to be developing to attain yet higher price levels will cause the question of rubber tires to be taken up seriously by such makers of motors cars as are trying to reduce price without paying tribute to efficiency of service of the cars.

The so-called high wheel self-propelled vehicle kept to the solid tire, and the diameter of the wheel was the saving factor in making the vehicle wear well. The carriage builder has gone through the school, has calculated strains, figured out the molecular action of shock on metals, and the only additional factor he had to think about was the effect of high speeds.

We have heard most about the derangement of the parts of the power mechanism if air tires were not used. The fact is practice does not show the point to be well taken. The solid-tired wheel communicates its vibratory strains and ensuing damage more to the axles, and after them to the frame, than to the engine, and the less the diameter of the wheels the more rapidly deterioration sets in.

There has been a tendency to increase diameter of wheels, even where protected with air cushions on the

rims. Progress will most likely still further develop along such lines.

Springs will lengthen, too, and become better shock-absorbers so far as the frame is affected.

A way will be thought out and be practically applied to transfer the air cushion from the periphery of the wheel to a point between the wheel and the frame that will answer the purpose of the air cushion better than in the position in which it is now used, and at great saving of expense and material.

When the stress of competition due to overproduction of automobiles becomes an urgent matter—and the time is close at hand, we will hear much more on the subject. If necessity is the mother of invention, she is also the god-mother of improvement. She will soon have her work cut out for her.

Along with this will come the simplification of the parts of the engine. To-day it is too highly articulated, too many parts. It must be skeletonized.

We think we see in these coming evolutions the opportunity of the carriage builder, as he is well equipped with a long experience in vehicle building that should prove of the highest value.

Already we find that abroad the builders are thinking about this subject. Who will be the pioneer in improvement, the Yankee or his foreign brother maker?

Careless Treatment of Varnished Surfaces.

The varnish maker is having his troubles these days, due to the carelessness and inexperience of those who have the care of the finished vehicle in hand.

The driver of the car, the garage employe, and about all those who have the care of cars in hand are people who have been pitchforked into the business because of its opportunities for good wages. The owners or managers of the public garages had no riper experiences. It was new business.

The varnish-covered body was treated in the theory that it was about as durable as the metal of which it was made. It was found that naphtha would slick off the mud and grease in short order; that it was equally effective in eating up the varnish had to come with experience. When the varnish went it was put up to the body maker. What could he be thinking about to cover the surface with something less durable than cast iron? Some of the very large expense for up-keep can be traced to just such lack of knowledge. Think of a coachman washing his carriage in this way, and think of the finish of such coachman who knew so little about his business.

It is a high testimony to the character of the varnish product of high-class makers that it so well withstood the abuse to which it has been subjected. No material is fool-proof but the varnish has given a mighty good account of itself under severely trying conditions.

Weekly Consular and Trade Reports.

Considering that these reports may be had for the asking by applying to the government Bureau of Manufactures, it is remarkable that they should be missing on the desk of any manufacturer in the country. To some they would be of the greatest value; to others a liberal education in world commerce—and all without price. It is strange such an opportunity should be allowed to pass.

Oxy-Acetylene Welding.

This recent method of welding by means of the application of gaseous compounds projected onto the welding surfaces by means of pressure generated by the gases has achieved noteworthy results. The character and ex-

tent of the welds, and the cohesion of surface is something worth having, and as the process is rapid, simple and easily manipulated we would suppose it might be very interesting to carriage builders as an adjunct of the smith shop, especially as the metal working branch of the business will presently assume much prominence in view of the attention being given to motor car construction.

HICKORY DECREASING SUPPLY.

In co-operation with the National Hickory Association, the United States Department of Agriculture has just completed a canvass of the principal hickory-using establishments to ascertain their annual requirements.

In the last few years the users of hickory have become very much alarmed over the decreasing supply; so far, however, it has been impossible to get satisfactory statistics either of the total quantity of hickory yet standing in the forests or of the amount used each year. This is partly because a great deal of hickory is cut by small portable or by stationary mills, which, after consuming all the timber within a radius of from two to eight miles, are either sold or moved to new points. Much hickory is also split into billets for spokes, handles, etc., instead of being sawed into lumber. Altogether, therefore, it is extremely difficult to make even a fair estimate of the total hickory consumption.

While the figures gathered by the Association and the Department are not as complete as were desired, they are at least significant. Hickory is especially sought for the manufacture of vehicle parts and of handles, in which great strength and toughness, together with moderate weight, are essential. It is estimated that, in the manufacture of their special products, the hickory-using establishments consume the equivalent of the following:

| Product | Quantity of Hickory Used in Equivalent Board Feet |
|---------------------------------------------------------------|------------------------------------------------------|
| For spokes | 45,000,000 |
| For handles | 29,000,000 |
| For poles and shafts | 18,000,000 |
| For rims | 16,000,000 |
| For singletrees, doubletrees, neckyokes and bolsters | 16,000,000 |
| For axles | 6,000,000 |
| For sucker rods | 1,000,000 |
| For vehicle gear woods | 600,000 |
| Total | 131,600,000 |

In addition to the hickory which is made directly into these special forms there is manufactured each year about 300,000,000 feet of hickory lumber most of which is later remanufactured. The total quantity of hickory cut in the United States each year is therefore equivalent to not less than 330,000,000 board feet. According to the reports of the Bureau of the Census, the average value of hickory lumber at the mill is about \$30 per thousand, while the high grade material which is necessary for the special uses listed above is worth at least \$50 per thousand. This makes the total value at the mill of the annual hickory production not less than \$12,000,000.

Hickory is one of our most useful woods, but it constitutes only about two to five per cent of the total stand of timber in our hardwood forests. It is widely distributed throughout the Eastern hardwood forests and was formerly most abundant and of unusually high quality in Indiana and Ohio. The supply in these states, however, has been greatly reduced by cutting, so that at present Arkansas is distinctly in the lead in hickory production, followed by Tennessee, and then by Indiana, Kentucky and Ohio.

The F. A. Whitney Carriage Company, Leominster, Mass., has plans for a new brick factory to replace the frame building destroyed by fire.

Vehicle Fashions for April 1910

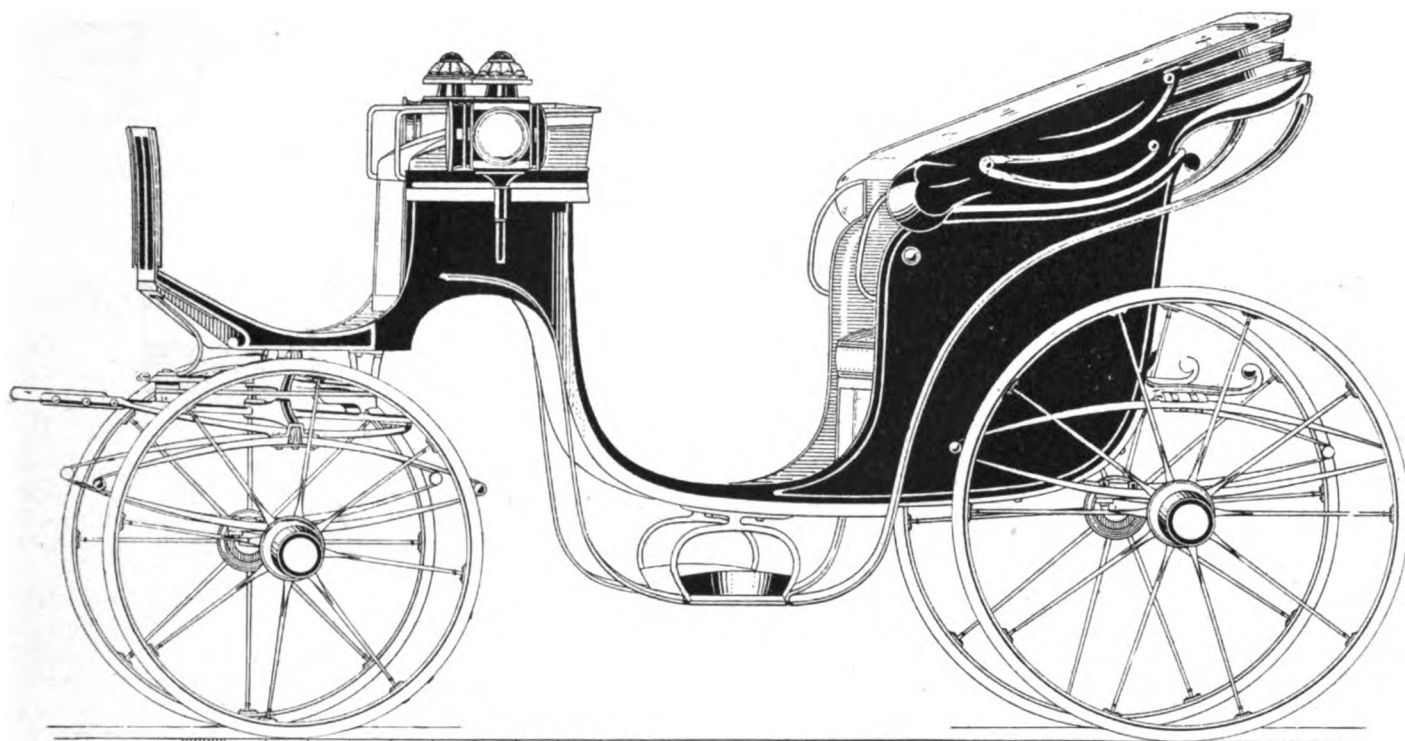

MYLORD.

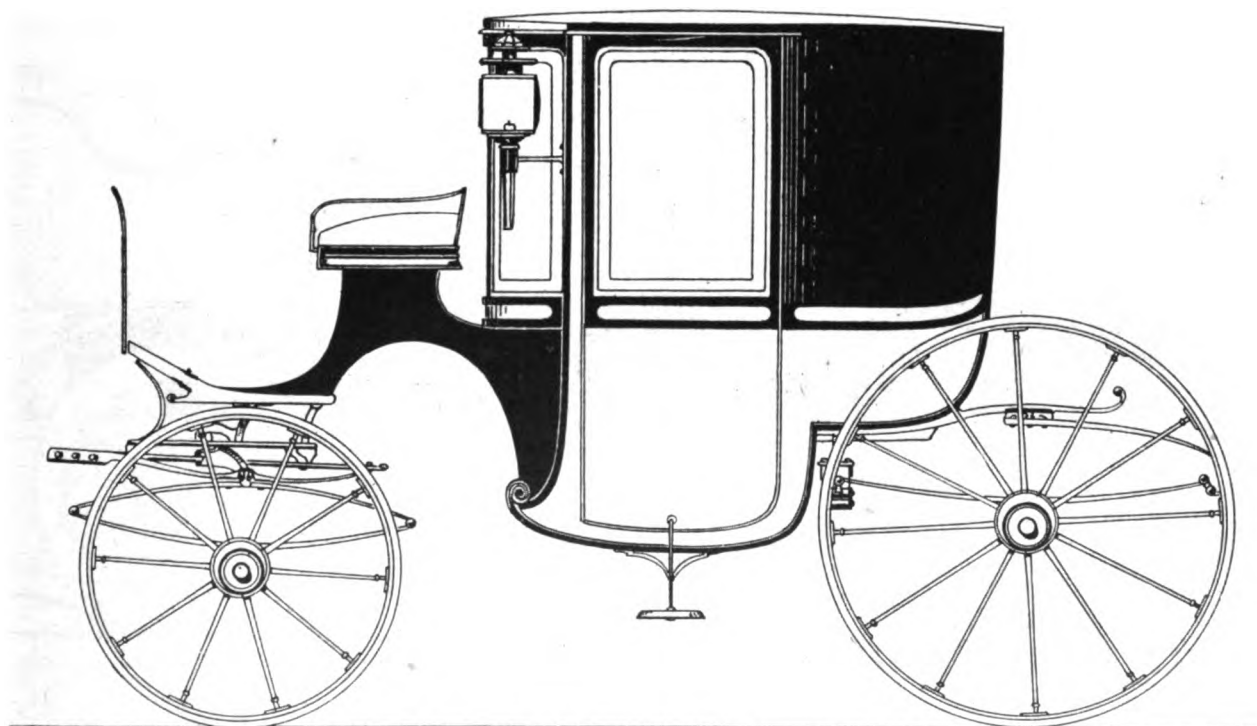

COUPE.

Two Styles of Foreign Vehicles

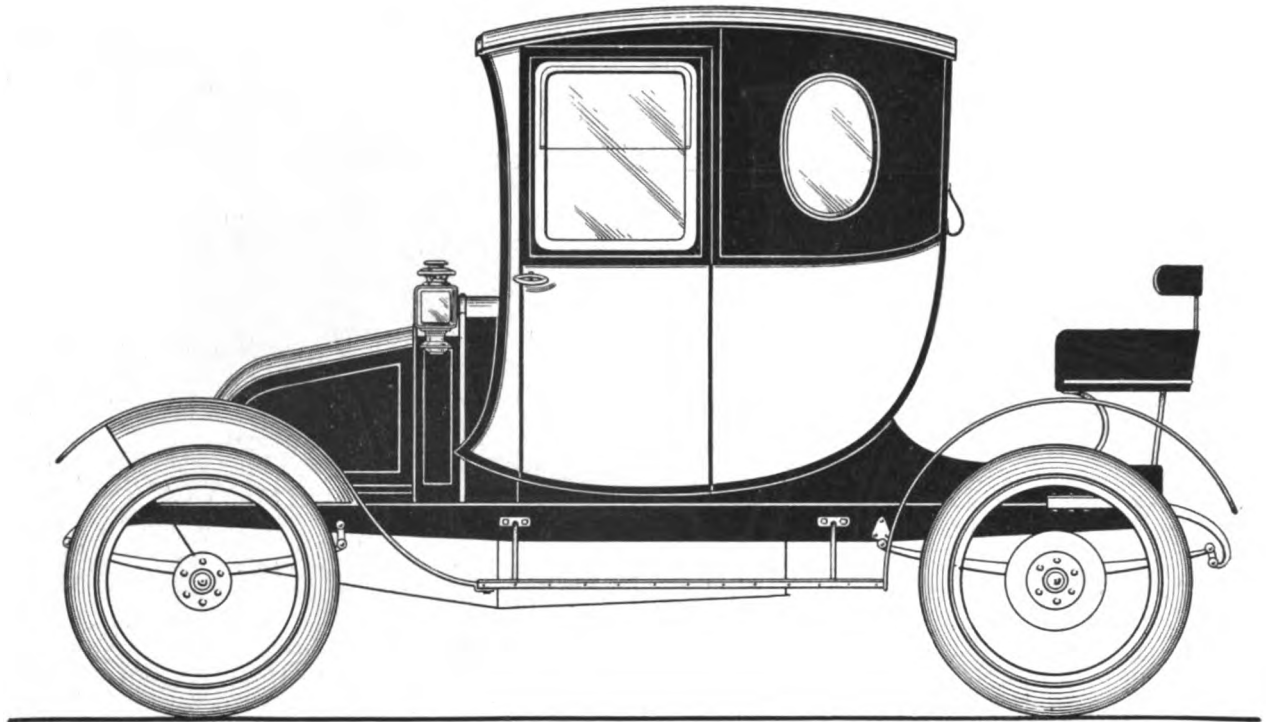

FRENCH AUTOMOBILE BODY DESIGN.
(Described on page 27.)

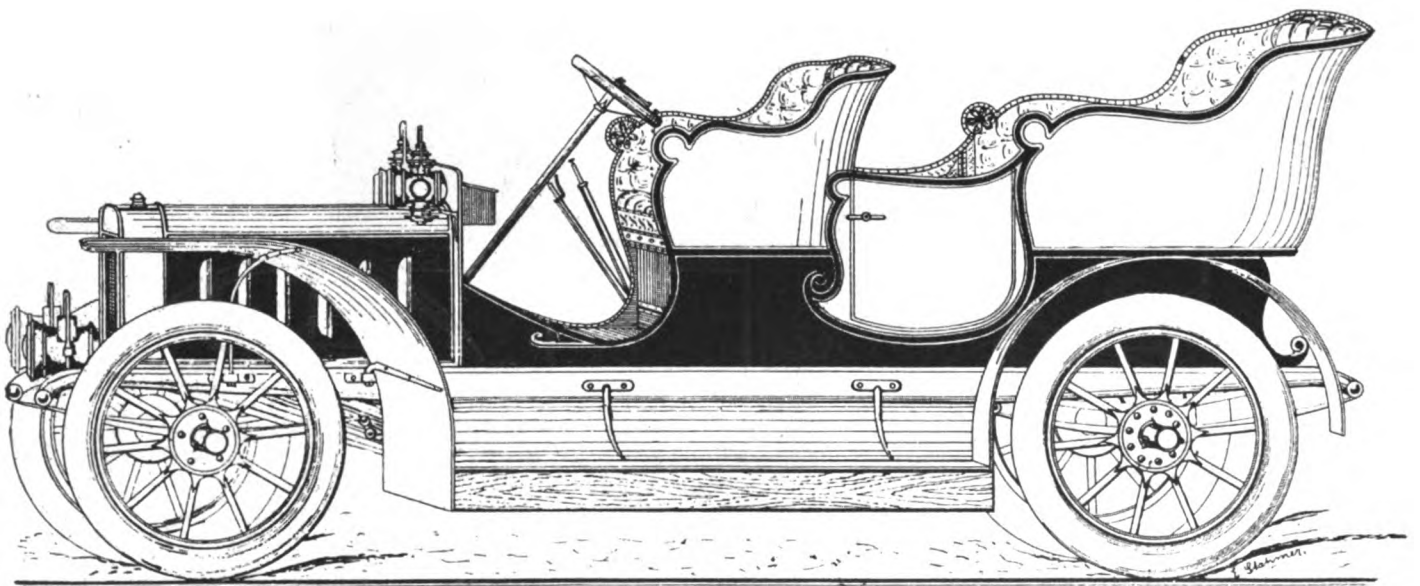

DESIGN OF DOUBLE PHAETON AUTOMOBILE.

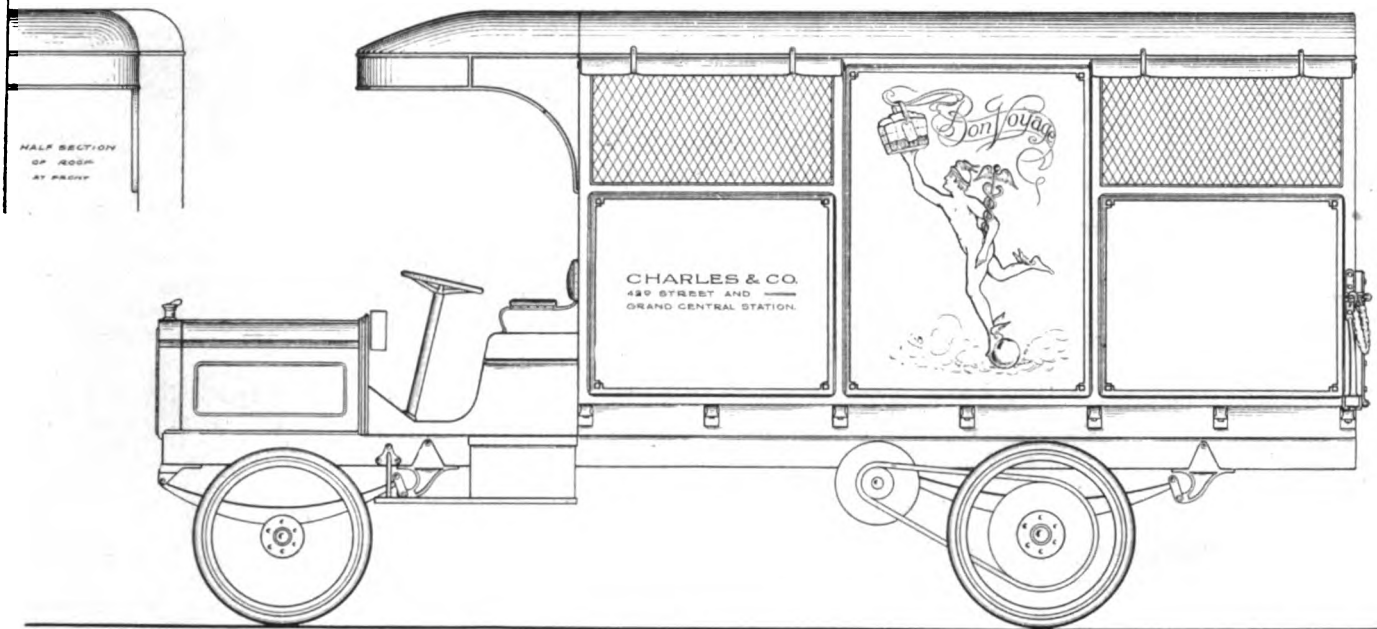

MOTOR GROCERY DELIVERY WAGON.
(Described on page 27.)

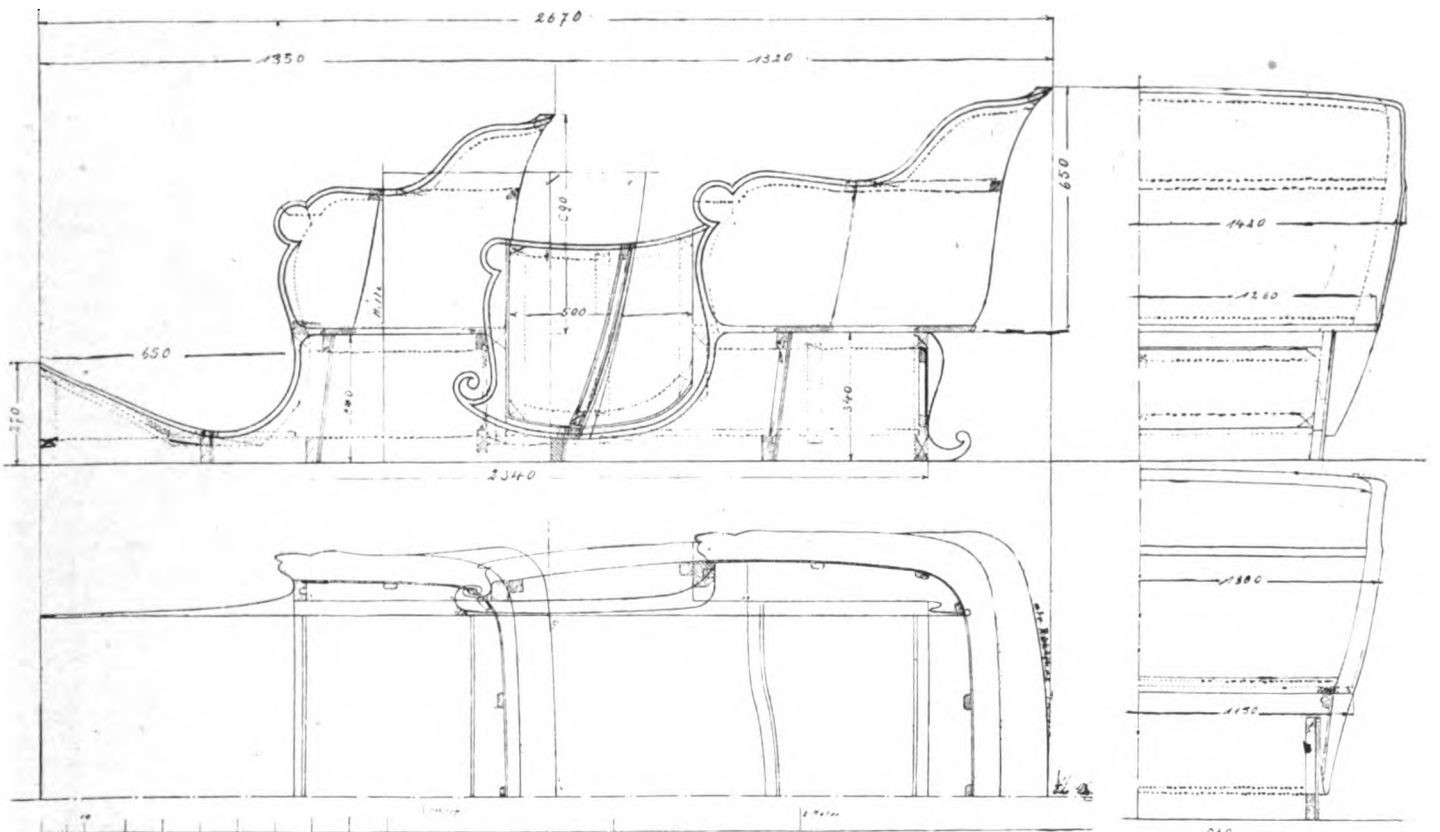

WORKING DRAFT FOUR PASSENGER AUTO BODY.

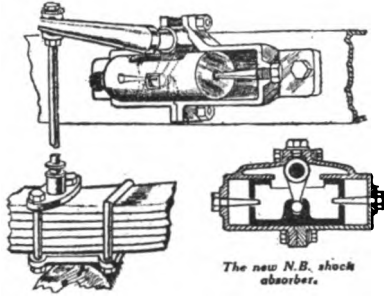

Newton and Bennett.

The new N.B. shock absorber.

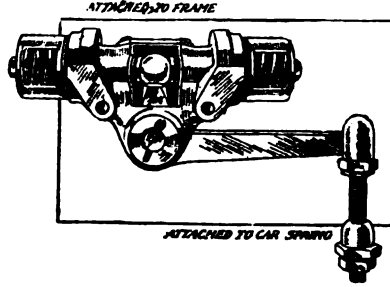

"Amans"

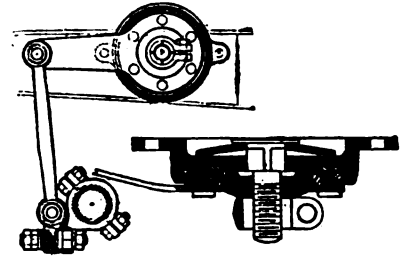

Traffault.

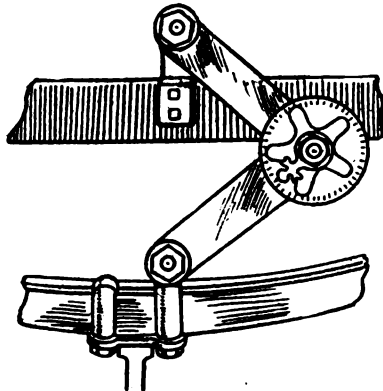

Traffault-Hartford.

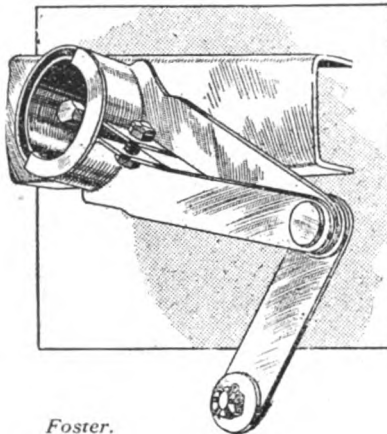

Foster.

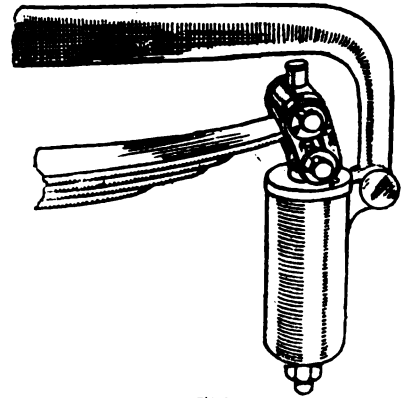

J.M.

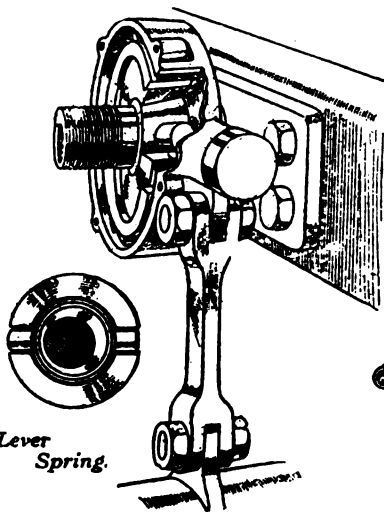

Lever Spring.

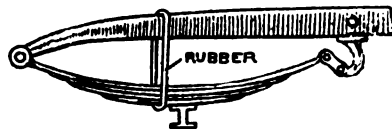

Mercedes racer.

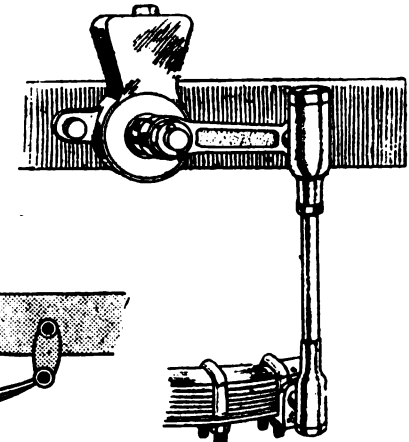

Houdaille.

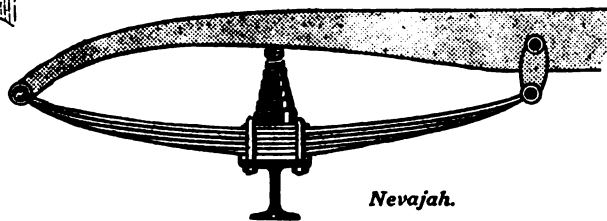

Nevajah.

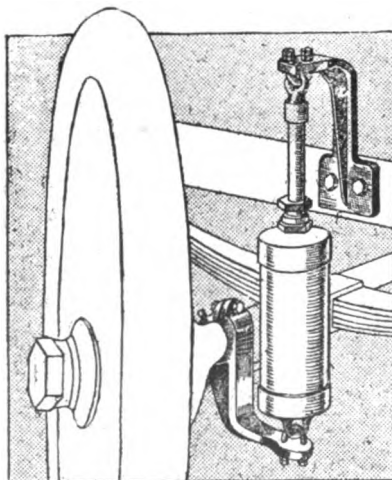

Fleutje.

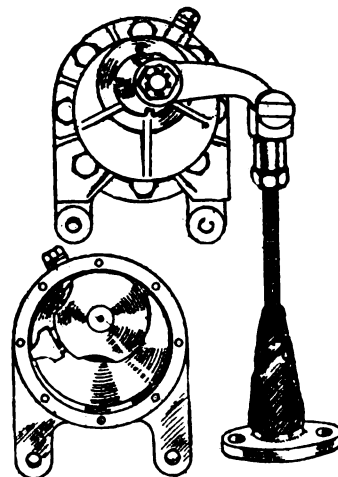

Warwick-Wright "Hydraulic."

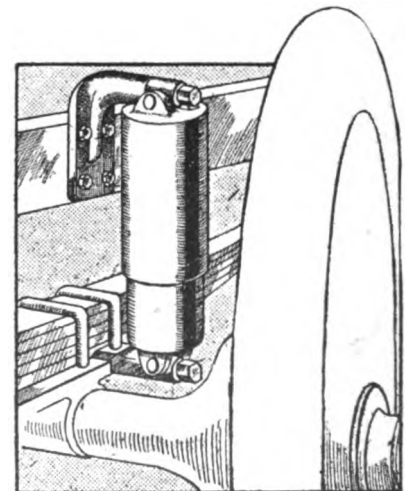

Kilgore.

VARIOUS TYPES OF SHOCK ABSORBERS. (See article on page 24.)

Wood-working and Smithing

ALLOWANCES FOR WELDING.

The question of how much metal should be allowed for making a weld when the length and cross sectional area of bar is important, has always been a debatable one with blacksmiths.

I have never found, in any book dealing with the trade, any writer who was prepared to state in exact terms what amount should be added for the purpose.

In ordinary practice, the smith uses his judgment, based on his experience, together with the nature of the weld, and the size of the bars. This being the case, it is reasonable to suppose that if two smiths had to do the same piece of work they would, like the doctors, disagree. One might allow half the thickness, and the other a whole thickness of the bar.

It is a peculiar fact that in the instances mentioned, both could be correct as far as the length was concerned, but not so the strength.

I have lately made a number of tests of bars welded with varying allowances. I have done so in an endeavor to lay down a rule which would enable one to make the strongest weld, with a reasonable amount of labor.

I might here be permitted, for the information of those who are uninitiated in the art of welding, to explain the reason why an allowance is necessary at all.

It might be supposed that if a smith took two pieces of iron, let us say, 1 inch in diameter, and each 6 inches long, and welded them together, their combined length would be 1 foot; but such is not the case, because a loss would take place, partly due to the high temperature used and partly to the greater density given to the hammered portion of the bar. The loss is generally attributed to waste in the fire, but it is small compared with that of the compression by hammering, hence the difficulty of making an exact allowance.

To ensure having the welded part equal in sectional area when finished, it is essential that the ends should be larger previous to joining together. Now the amount of that increase of size will effect the ultimate result. If, for instance, two welds were to be made with the same material, and in one case the amount of upsetting was equal to 10 per cent., and in the other 25 per cent; and also supposing the temperature used to be the same in both cases, the one which was upset most would be the shortest on completion. In any attempt, therefore, to lay down a uniform allowance so that the length and cross sectional area will be correct, the extent of previous upsetting must be taken into consideration.

The question resolves itself into this: "What is the least amount of upsetting that a weld can be made with, so as to guarantee not having a reduction in the cross-sectional area of the bar, either at the weld or in its immediate vicinity, combined with a maximum of strength?"

The ultimate strength should always be a determining factor with blacksmiths, for in many instances human life is imperilled, as in the case of crane hooks, slings, chains, etc., and in others where the value of a machine is proportional to the strength of its welded parts.

Since the introduction of mild steel for structural purposes, welds have to a large degree been dispensed with, owing to the molecular form of that metal permitting it to be bent, twisted and otherwise formed into shape without loss of strength; the same not being permissible in iron, on account of its fibrous nature, which often requires it to be welded, so as to place the grain in the direction of the greatest strain. For all that, iron is still largely used, and mild steel is frequently welded in cases where it is more convenient to do so than forging from the solid.

TEST OF WELDS—Made at the Working Men's College, Melbourne. Showing the strength with different allowances for waste, etc.

| No. of Test. | Material | Allowance for weld. | Broke at | Breaking load. |
|--------------|---------------------------------------|---------------------------------------|--------------|----------------|
| 1 | $\frac{3}{4}$ in. diam. iron | $\frac{3}{8} = \frac{1}{2}$ diameter | Near weld | 23,600 |
| 2 | $\frac{3}{4}$ in. diam. iron | $\frac{3}{8} = \frac{1}{2}$ diameter | At weld | 22,900 |
| 3 | $\frac{3}{4}$ in. diam. iron | $\frac{3}{4} = 1$ diameter | In bar | 24,160 |
| 4 | $\frac{3}{4}$ in. diam. iron | $\frac{3}{4} = 1$ diameter | In bar | 25,675 |
| 5 | $1 \times \frac{1}{4}$ in. diam. iron | $\frac{1}{8} = \frac{1}{2}$ thickness | Near weld | 12,400 |
| 6 | $1 \times \frac{1}{4}$ in. diam. iron | $\frac{1}{4} = 1$ thickness | Bar in clips | 14,150 |
| 7 | $\frac{1}{2}$ square iron | $\frac{1}{4} = \frac{1}{2}$ thickness | Weld | 13,650 |
| 8 | $\frac{1}{2}$ square iron | $\frac{1}{2} = 1$ thickness | Bar in clips | 15,000 |
| 9 | $\frac{1}{2}$ retested | $\frac{1}{2} = 1$ thickness | Bar in clips | 15,225 |

The foregoing table will show the result of my investigations in connection with this problem. It will be noticed that in all cases where the allowance for welding equalled one thickness of the bar, that the tensile strength was higher than when only half that amount was allowed. The welds were carefully made, special regard being paid to the length and cross-sectional area, the number of heats being the same in each case, and the temperature as nearly equal as can be judged by the eye.

The results prove that the great difference in length and strength was due to the amount of upsetting, and not to the number of heats used, or the temperature that the iron was raised to.

In conclusion, I have no hesitation in asserting that where one thickness of bar allowance is made the weld will be more reliable than with a lesser amount, and to obtain the same the thickness the ends of the bars should be upset until they are equal to 1.25 that of the original size, and should gradually taper back from two or three thickness in length.—The Automobile and Carriage Builders' Journal.

IMPROVED SUSPENSION.

The AAAA forms a parallelogram, two of the points of which are secure to the axle (E^1 , E^2) with the front each of the side rods attached to a member free to revolve on the points (F , F^1). The free links on the ends of the springs (S , S^1) permit of this; the double-forked torque rod (B , B and B^1 , B^2), fitted to D , D^1 and G , G^1 , controls the lateral movement of the axle while permitting perfect freedom of vertical motion.

The cardan shaft (C) has a sliding block and telescopic fitting at the front end and a cardan joint at the rear end. It will be seen

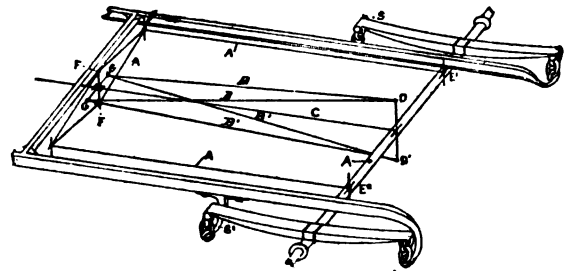

that a free, direct, vertical action of the frame is provided for, as well as the slight lateral action of the rear axle, and a fore and aft action of the springs on either side; these latter limited by the length conformation and disposition of the links. This gives to the driving axle of the car an amount of freedom of movement in relation to the plane axis of the chassis, which cannot be obtained in the ordinary way, the driving effort from

MOTOR BODY FRAMING.

The diagrams of sectional motor body framing which are given herewith to illustrate this article, show the hind quarter of a deep quartered cab phaeton motor body in Fig. 1., in which it is explained how the framing of the front pillar to the bottomsides by stump tenon is done, and fixed with screws, also the half checking of the elbow to the pillar and corner pillar.

The corner pillar and bottomsides are slip tenon and half check shoulder framed—the framing being held more firmly with a light top plate fixed with screws. The framing is made to have a double shouldering form the tenon to the outer surface. This provision prevents the joint from shifting, as the result of up-

In dressing up the corner pillar N., first lay out the plan of the quarter as in Fig. 3. Having been given the extreme widths of the body over standing pillar, across back on elbow line, and the amount of turnunder, make the corner pillar pattern, Fig. 4, which is made from the elevation Fig. 1. Then make the turn-under pattern, which is, of course, the contour line of the standing pillar 9, Fig. 1. Now these are the two principal patterns, and to dress the corner pillar up correctly mark off on the face side of the pattern horizontal lines as in Fig. 4, and transversely across the back of the pillar N., as in Fig. 2. Now to get the correct angle for the horizontal square, take the shoulder from the plan Fig. 3 at N, and hold the horizontal square to the lines in

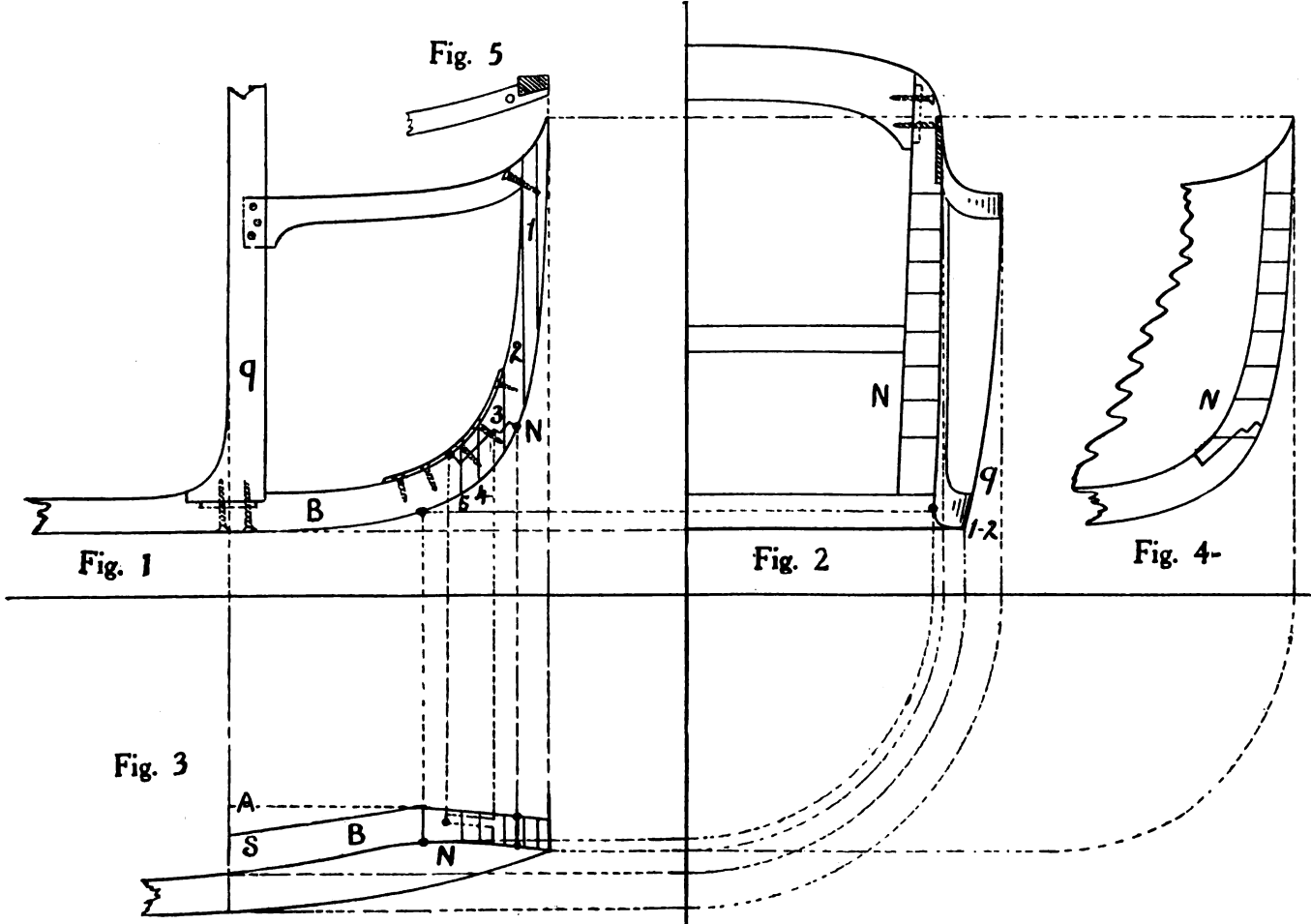

ward or sagging action, and makes a first class job whether in a motor body or in Brougham bodies, where the method was universally employed before the solid bottomsides and corner pillar in one was introduced.

Fig. 2 shows the back section of the body, and the framing of the top cross rail, and the edge line of the elbow framing to the back corner pillar. To kill the jointing of the elbow on the pillar, a bead is run up into the joint, thus absorbing the end grain of the elbow in the line of the bead, while at the same time a clean and artistic finish is worked up.

Fig. 4 is drawn on to enable an explanation of how the corner pillar N, which is framed to the bottomsides at an angle, should be dressed up.

The bottomsides B is mostly got out on a square line on the inside as at A, Fig. 3, so as to take the chassis, but allowing the side swell of the body to stand at a projection. In that case the bottomsides is dressed up square, and the side swell on the turn-underline worked on the outside. But should the bottomsides B be framed in narrower timbers, and angled to meet the framing of the body in this way, the bottomsides line would be pitched to show a regular width, as explained and divided off by the line S in Fig. 3.

Fig. 4, and turn the blade round to the angle of the shoulder of the pillar as shown in the plan, Fig. 3, and dressing the pillar from top to bottom with the horizontal will bring the surface in beveled correctness to line with the bottomsides, to which it is framed.

Another method of dressing up the corner pillar is to use an ordinary bevel, and set it to the shoulder of the pillar N on the plan Fig. 3, and hold the bevel shoulder vertical on the lines of the pillar—1, 2, 3, 4, 5, which are marked off on the pattern from the elevation Fig. 1. The bevel thus held allows the blade to lay at the horizontal line through the vertical position of the shoulder, and thus the surface of the pillar on its outer edge is dressed in line to its angled position to the bottomsides. This is a method used in dressing the corner pillars of the back quarters of Broughams with short mitre point bottomsides, framed in exactly on the principle of the quarter under treatment in Fig. 3. The framing of the elbow to the corner pillar is shown in Fig. 5. A body maker wishing to gain practical information at the bench will be very materially helped by a study of the diagram drawings herewith, because every point for workshop guidance is shown in them, and with the effort of practical study. Valuable help can be garnered from their perusal.

CINCINNATI CARRIAGE MAKERS' CLUB.

The Carriage Makers' Club of Cincinnati, Ohio, held its regular meeting at the Grand Hotel on March 10th, with an attendance of 62 members and four guests. The meeting was presided over by Second Vice-President L. D. Lutz. After the reading of the minutes of the February meeting, the resignations of W. P. Nolan, of the Motor and Horse Vehicle Magazine, and F. E. Blunden, of the Whitaker Paper Co., were accepted.

Mr. Shipley, chairman of the special committee appointed to assist the Tariff Board in the regulation of export duties, made a very interesting report in connection with the work that had been done so far, setting forth the discrimination against this country by the Brazilian Government. The committee was authorized to continue the work.

A communication from the Business Men's Club, in regard to a business men's excursion into territory contiguous to Cincinnati was read and referred to the executive committee.

At the conclusion of the business of the meeting, the members were delightfully entertained by Miss Frieda Lotze in eloquent work.

This meeting was the occasion of the annual election of members of the board of governors. Of the eight nominees, the following were elected: David B. Gibson, Jason Schneider, A. J. Sebastiani, C. W. Shipley. This concluded the business of the meeting and adjournment followed.

AFTER THEIR RIGHTS.

Interstate Commerce Commission hearings were held at Toledo, Ohio, by Commissioner Mosely. The principal case was that of the Milburn Wagon Co., which alleges discrimination of freight rates on a shipment of wagons to a point in California. The company asserts it should have been given the terminal rate of \$1.25 per hundred to Los Angeles, instead of which it was charged \$2.71 per hundred. The discrimination was caused by an alleged alteration in the way bill, which resulted in a mis-rating of the shipment. The commission is asked to fix the responsibility for the alteration of the waybill, in order that the company may recover the overcharges.

The recent increase of 10 cents per hundred on wagons to northwest coast points was the subject of another case brought by the Milburn Wagon Co. against the lines forming the Transcontinental Traffic Associations.

KELLY TO LOCATE IN RACINE.

Although originally intended for Toledo, O., the new rubber company which Charles F. U. Kelly has had in the making for some months, is to be located in Racine, Wis., and has been incorporated under Wisconsin laws as the Kelly-Racine Rubber Co., with a capital stock of \$500,000. The new company, of which Kelly is the president, and which will make automobile, commercial truck, motorcycle and bicycle tires, has purchased ten acres of land in Racine for a factory site, and construction is to be started immediately on a fireproof plant. It is expected to have 250,000 square feet of floor space available for active manufacturing operations in the latter part of July, and an output of 300 tires per day from the start has been promised. The change in plans by which Racine instead of Toledo becomes the home of the company, was brought about by the substantial inducements that were offered by Racine business men, a number of whom have become associated with the enterprise.

NEARLY READY.

About \$3,700 of a necessary \$5,000 of stock to be subscribed has been pledged for the Journay Manufacturing Co., of Portland, Maine, to build wagon boxes, wagon trucks, bob-sleds, etc. It is capitalized at \$50,000.

WAGON COMPANY COMPLAINS OF RATES.

The complaint of the Springfield Wagon Company against the Frisco Railroad alleging the rate on steel material used in the manufacture of wagons is excessive will be heard before the Missouri Railroad and Warehouse Commission in St. Louis, May 3.

The contention of the wagon company is that the railroad company is attempting to avoid the seventeen cent rate on bar iron from Springfield to St. Louis, by classing shipments of iron as steel. Following a hearing of the original complaint of the wagon company, the railroad board made an order compelling the Frisco to change the rate on bar iron from St. Louis to Springfield, from 22 cents per hundred pounds to 17 cents per hundred pounds.

A shipment of bar iron from St. Louis to Springfield precipitated the present complaint. In a letter to the State Board the wagon company alleged that the car, though billed through to Springfield as iron, was changed to steel upon its arrival and that the company would be compelled to pay the old rate of 22 cents per hundred pounds, instead of 17 cents as ordered by the board.

The wagon company officials contend that they are at times compelled to alternate in the use of iron and steel. When they are unable to get shipments of steel they say they are compelled to use iron in the manufacture of tires and other fittings for wagons. On the other hand they say they often use iron instead of steel when they are unable to get a sufficient supply of steel.

IN THE DREADNAUGHT CLASS.

The development of the motor car brought in its train a class of men not used to the handling of fine vehicles. They were just as likely to smear the finished surface of cars with greasy rags as with clear water. There was no regard for a varnished surface.

To meet such severe usage, Valentine & Company originated and introduced their line of Vanadium Varnishes, which are designed to be almost negligence-proof.

They present hard yet elastic and brilliant surfaces that are not easily put out of commission, and of a durability that puts them in a "Dreadnaught" class, which means invincible.

The painter will find their working qualities admirable, and their extra paleness is only one of the attractive attributes we can mention.

The Vanadium line is compounded with remarkable adaptation to the end in view, and has achieved distinction already.

FUTURE OF "AMERICAN VEHICLE."

The late Mr. Sherron had so many friends interested in his welfare that it will be well-received news to print the plans made for the immediate future conduct of his journal. It is most gratifying to know that the widow's interests are to be so unselfishly conserved in place of being sacrificed. Mr. Wright has undertaken the work, and for the present, at least, will be responsible for the editorial conduct of the journal. We believe that the late Mr. Sherron's policies will be adhered to as closely as can be done by an editor in sympathy with his ideas, but who will necessarily, to an extent, inject into the work his individuality.

DEALERS ORGANIZE.

The Huron County (Mich.) Implement and Vehicle Dealers' Association has been organized with thirty members. It is said to be the largest county organization of the kind in the state. The officers are: President, E. Paul, Pigeon; secretary-treasurer, Joseph Wagner, Kinde. A banquet was served at the Hotel Morrow at the close of the business session.

STANDARDIZED RIMS PULL THROUGH.

Instead of being dissolved as the result of the difference exhibited toward it by the tire committee of the Association of Licensed Automobile Manufacturers, the project for a standard type of quick detachable rim, as evolved by compromise on the part of six big companies, has taken a new lease of life and is to be pushed with vigor. Tangible evidence to this effect is afforded in the official announcements made, over the names of the companies that have assigned their rim patents to the United Rim Co., the patent holding corporation created for the purpose.

The plan for a standardized type of quick detachable rim has been making difficult progress for the past two years, but those who have championed it are now convinced that it has reached a point where it may be put squarely before the trade and the public. The companies who are pledged to the cause and who have turned over their rival and conflicting patents to the United Rim Co., in order that the latter may authorize a composite type containing the best features previously found separately, include the Diamond Rubber Co., Akron, O.; G. & J. Tire Co., Indianapolis, Ind.; Goodyear Tire & Rubber Co., Akron, O.; B. F. Goodrich Co., Akron, O.; Hartford Rubber Works Co., Hartford, Conn., and Morgan & Wright, Detroit, Mich.

When the United Rim Co. made its initial attempt to create a standard type which would be acceptable from all standpoints, it encountered trouble with the rim manufacturing concerns who were approached on the matter of taking out a license to manufacture. The rim makers balked at being confined to just one type, which they must needs be under the terms of the license offered them. The United Rim Co. then agreed to license them for two standard types, provided they would give up the manufacture of all competing rims. These two standard types were designated as types No. 1 and No. 2. Licenses for their manufacture were taken by the Standard Welding Co., of Cleveland, O., and the Weston-Mott Co., of Flint, Mich., with the understanding that the tire companies themselves would retire from rim manufacture.

Later a dash of cold water was thrown on the whole thing by the attitude of the tire committee of the A. L. A. M., which refused to take any definite steps toward pledging support for the standardized rim idea or to recommend it to the membership of the association. With renewed courage, however, the standard rim is again taken up and is to be carried to the ultimate of whatever possibilities are in store for it. The No. 2 rim is the type which is to be made the leader, although the rim manufacturers who have taken out a license may make the No. 1 type also if they find reason to do so. The tire companies who have created the United Rim Co. will themselves cease the manufacture and sale of rims on the first of next July, and will use their combined efforts to make the car manufacturers and the public see the advantage of the standardized type, as produced by the licensed rim makers.

AUTO NOT A CARRIAGE.

A recent Massachusetts court decision says: "It is certain that when this statute was originally enacted the legislature, in using the word 'carriage' had no thought of a vehicle made up in large part of complicated machinery and propelled by a powerful engine whose operation is similar to that of a locomotive engine on railroads. We are of opinion that automobiles are not included in this statute."

GREAT CHANCE IN NORTH CAROLINA.

The Board of Trade of Winston-Salem is energetic in exploiting the advantages of the locality. The catalogued advantages include best railroad service, excellent climate, no labor troubles and good manufacturing neighbors who are already on the ground. Already there is a \$519,000 product of wagons and carts as one of the evidences that it is a good place for vehicle builders.

OLDEST "JOB" IN THE LAND.

What is claimed to be the oldest vehicle in America is in possession of the Chamber of Commerce, Los Angeles, Cal. It was made by the Pueblo Indians of Tesuque, and was purchased in 1878 from a native, who at that time was 85 years old. His statements and the traditions of the village were to the effect that the big-clumsy ox-cart, or carreta, was handed down from father to son for sufficient generations to place its origin in the seventeenth century.

Whether or not its age is as great as that, the primitive cart is interesting, both for its known history and the oddity of its

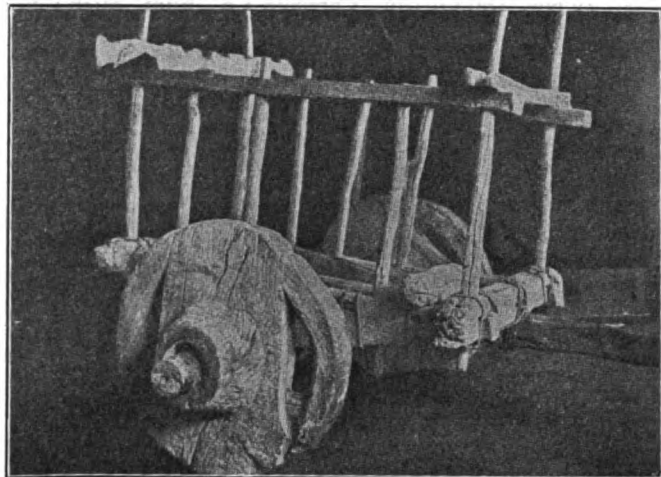

design and workmanship. It is composed of wood and rawhide throughout, no metal being used in its construction. The wheels are heavy sections of sycamore, with clumsy, bow-like pieces of rim secured opposite each other on each wheel. The diameter of the two ungainly wheels is 38 inches. The axle is of hard wood and the 12-foot tongue consists of a single length of mesquite. The body of the vehicle is 6 feet long and very broad and high in proportion. It is of a rude, rack-like construction.

PRELIMINARY STEP IN BILLION DOLLAR COMBINATION.

Mr. C. A. Carlisle, chairman of Publicity Committee, furnishes the following: "As a result of the merging of the interests of the Studebaker Brothers Manufacturing Company and the E-M-F Company, a meeting of the Board of Directors of the Studebaker Brothers Manufacturing Company was held at the offices of the company in South Bend, Wednesday, March 23, and at the invitation of the management Walter E. Flanders, the president and general manager of the E-M-F Company, and Frederick W. Stevens, of J. P. Morgan & Co., of New York, accepted nomination and were elected members of the Board of Directors of Studebaker Brothers Manufacturing Company. Both are now members of the Board of Directors of the E-M-F Company."

BOUGHT THE BUILDING.

Through Trustee Copeland the building at the Columbus and Chillicothe Pike and the Hocking Valley Railroad track formerly occupied by the Columbus Woodenware Company, Columbus, Ohio, was transferred to the Ohio Carriage Company, which has been occupying the structure for some time. The consideration was \$42,500.

GOING SOME.

At the West Chester Wheel Works, Westchester, Pa., there is an engine still in use which was installed when the plant was started over forty years ago, having been used at the original plant in West Goshen.

C. B. N. A. COMMITTEES.

The newly appointed committees of the Carriage Builders' National Association are made up as follows:

Board of Trustees of Technical School—Charles J. Richter, chairman, 119 West Seventy-third street, New York; Hon. Franklin Murphy, Newark, N. J.; Wm. W. Ogden, Newark, N. J.; Wm. R. Innis, New York; D. T. Wilson, New York.

Committee of Freight Classification—Theo. Luth, chairman, Cincinnati, Ohio; A. G. Brunsmann, Cincinnati, O.; C. W. Nash, Flint, Mich.; W. H. Roninger, St. Louis, Mo.; H. B. Staver, Chicago, Ill.; A. M. Parry, Indianapolis, Ind.

Advisory—C. A. Barnard, Anchor Buggy Co., Cincinnati, O.; W. N. Agnew, Durant-Dort Carriage Co., Flint, Mich.; E. C. Meyer, Banner Buggy Co., St. Louis, Mo.; C. S. Bailey, Staver Carriage Co., Chicago, Ill.; C. T. Platte, Parry Mfg. Co., Indianapolis, Ind.

Committee on the Conservation of the Resources of the Country—Henry Ratterman, chairman, Cincinnati, Ohio.

Committee on the Abuses in the Carriage and Accessory Trades—Perrin P. Hunter, chairman, Cincinnati, Ohio.

Committee on New Members—Fred O. Nuetzel, chairman, Louisville, Ky.

Committee on Dealers Associations—A. G. Brunsmann, chairman, Cincinnati, O.; Russell E. Gardner, St. Louis, Mo.; A. M. Parry, Indianapolis, Ind.; C. W. Nash, Flint, Mich.; Otto Armleder, Cincinnati, O.; Adam Howard, Galion, O.; J. G. Moon, St. Louis, Mo.; F. A. Ames, Owensboro, Ky.; W. C. Heath, Monroe, N. C.; C. O. Summers, Barnesville, Ga.

Committee on Good Roads—Henry F. Keachline, chairman, Philadelphia, Pa.

Committee on Credits and Terms—W. P. Champney, chairman, Cleveland, Ohio.

Committee on Costs—J. D. Dort, chairman, Flint, Mich.

Committee on Patents—John F. Galvin, chairman, New York.

Committee on Materials—Charles E. Adams, chairman, Cleveland, Ohio.

Committee on Press—J. Frank Hutcheson, chairman, Cincinnati, Ohio.

Committee on Fire Insurance—T. J. Sullivan, chairman, Rochester, N. Y.

THE RUBBER SPECULATION.

The speculation in rubber shares in London is attracting world-wide attention. Its results will have effects on the product and trade that will be important. The United States special agent gives some particulars concerning the situation.

The following statement will illustrate the shortage of india rubber: In the Dutch East Indies old rambong rubber trees, considered worthless a few years ago, are no longer cut down, except when they are in the way of newly planted Para trees. One East Sumatra estate in 1909 had a yield of nearly 1 pound per tree from 8-year-old trees. The cost of this rubber, delivered to London, as 28 cents per pound, and having been prepared by men who understood the business, it was sold in competition with Para rubber.

The fluctuations in the rubber market during the past three years can be best shown by comparing the different prices of fine hard Para rubber per pound:

In 1907, January, \$1.28, gradually dropping to 97 cents, until December, when it sold as low as 87 cents.

In 1908, January, 85 cents; February, 66 cents; gradually advancing, it sold in November and December as high as \$1.30.

1909, January, \$1.25; advancing slowly until August, when it sold for \$2.09; in September and November, \$2.19; in December it dropped to \$1.70.

In January and February, 1910, \$1.84 to \$1.98, with all prospects for a further advance during the year.

The comparatively good prices for this high grade rubber seems to be entirely due to the advantage that the manufacturer of a certain class of goods find in its use. It must be remem-

bered that the African grades of inferior rubber were available during 1909 at comparatively low prices. Sarawak-Jetalong was quoted as selling at \$97 to \$146 per ton during the past three years, and a few tons of old stock may be had now for \$122 per ton.

Bandjermassin rubber was reported as not obtainable in the London market at present, but direct shipments from Singapore can be made in March for \$139 per ton, f. o. b., Singapore.

Rubber plantations are being continually financed in London, and approximately some 300 plantations are owned by capitalists in the United Kingdom. The rubber market of London seems to have a bright future, as great developments are expected from the plantations, financed during the last five years, in Africa, Sumatra, Java, Madagascar, Malacca, British Borneo, India, Burma, New Guinea, and the Malay Peninsula.

London has a rubber growers' association, with a membership of some two hundred rubber planters and others indirectly interested in rubber growing. Antwerp has also a rubber growers' association, and many rubber plantations were financed from that city.

The principal members of the large manufacturing firms of rubber goods have secured controlling stock in some of the best-paying rubber plantations, and thus, by knowing the actual cost of production, are placed in a position to protect themselves on prices.

The International Rubber and Allied Trades Exhibition will be held in London in June, 1911, and is expected to be of considerable dimensions and much larger than any of its predecessors.

FLANDRAU CONTROLS BRASIER.

The old established New York firm of carriage builders, Flandrau & Co., while retaining its identity and control, has organized the subsidiary Flandrau Motor Car Co. for the purpose of exclusively handling in America, as selling agency, the Brasier motor cars.

Speaking of the Brasier, Mr. Wilson says: The Flandrau Motor Car Company is organized for the purpose of handling and importing the Brasier car, and in that respect only is separate and distinct from Flandrau & Company, which is still continuing to manufacture automobile bodies, and mounting them upon any make of chassis.

They build all sizes from 11 H.P. up, and make a wonderful car for taxicab purposes. We have nearly all these cars in stock. They are now finished with our coach work, and we believe we are showing the finest finished car in the country, and at a price less than is generally charged for that class of work.

CLEVER WAY TO PUT IT.

The Consolidated Rubber Tire Co., in keeping the memory of Kelly-Springfield tires green in the mind, has adopted a folder plan of advertising, as one means that has merit in its method. There is not much said, but it divides the waters of the Red Sea of opinion and shows a dry path to a safe crossing to safety in the use of rubber tires. At any rate, we so gather from what is said about "Miracles." Get the folder and be interested as we have been.

SIXTY YEARS YOUNG.

The sixtieth annual of the A. A. Cooper wagon factory was commemorated at Dubuque, Iowa, when Mr. Cooper quietly celebrated the event with a banquet. During the sixty years Mr. Cooper has stood at the head of the firm, which has never changed. It is said one hundred thousand men have been employed at the factory since it was started.

The Gerstenslager Buggy Co., at Wooster, Ohio, is crying for good mechanics. The officials say they could use a lot of good men just now and give them good positions.

FAULTS OF LEATHER.

The carriage builder has his troubles in working leather, so when he can get an expert in leather to ventilate his opinion, he avails himself of the opportunity. The Philadelphia wagon builders found that Mr. Peter Loehnberg was willing to tell some things out of his store of knowledge of leather, especially as used for coach and automobile. Substantially he said that such leather is made from the largest steer hides obtainable. The selection is difficult, as defects, of any importance, do not become manifest until the hides are unhaired and tanned.

The hides are taken to the beam house, where they are opened and put in the "soak," with lukewarm water, in order to remove the dirt. They then go into a tank of lime to soften the hair, so it can be shaved, on the same principle that a barber lathers a man's face before shaving him.

The hide is then laid over a beam, and a man with a flesher's knife shaves the hair off. The imperfections in the hide then become apparent. Barbed wire may have injured the hide.

The hide then goes to the tanyard, where bark extract and other liquids serve to "plump" the hide. This requires from fourteen to seventeen days, according to the weight of the hide. From the tanyard the hide goes through a press, which squeezes all the liquor from it, and it is then ready for the splitting machine. It must be semi-dry, else the knife marks would show.

On the union splitting machine the hide is made into four cuts or hides. The first cut is the "skiving," usually full of holes in places. This is used for the manufacture of inner soles for shoes. The next cut, "second split," or part nearest the body, is turned into cheap dash leather, shaft-tips, etc. The "main split" is used for tops and trimmings on cheap buggies.

The other cut is for carriages and automobiles. The "buffing" on hair side of the hide is about the thickness of a cover on a book, and is sold to the bookbinder. The machine-buffed leather of to-day, used on vehicles, comes near to hand-buffed of years ago. This leather is used by automobile and furniture manufacturers.

Another method of splitting hides for hand-buffed leather is to have a very light skiving removed, and then one other cut. This last cut is made into "doubles," Japanned on both sides, and made up into belts and similar articles.

The "deep buff" has a better grain than the split. The hand-buffed hide is buffed on a table and not run through a machine. The buffing having been taken off lightly makes a softer and more plump leather.

Regarding the price of hides twenty to thirty years ago, the green hides could be bought at five cents a pound, while to-day they are selling for twenty-one cents a pound, and the hides not so good. While then the patent leather sold for twenty-one cents a foot, to-day it brings only an average of twenty-five cents.

To-day good leather is scarce. Owing to the demand, cattle are killed younger than they were twenty years ago, and are not as large.

According to all statistics and records, it looks as if, in the very near future, the output of leather will be less than the demand. The 300,000 autos which will be made this year, the increasing demand for shoes, belting, etc., will require many hides. Because of this demand, the packer will not sort the hides as formerly, and consignments are rarely up to sample. But the buyer must take what is sent; there is no redress.

After the gentleman concluded his address some questions were asked by his auditors, and we note a few of them.

In answering about the cause of patent leather peeling, he said: One coat peels from another because the leather manufacturer is afraid to leave the leather in the oven too long, lest it burn. There is no fixed rule for baking, though the leather is tested from time to time. If allowed to remain too long, it burns, if removed too soon, the coats may peel, though that is a matter of temperature.

Speaking of grub holes, he said foreign cattle are driven with

prods instead of with whips, and the hide becomes punctured, usually on the butt.

In leather that bags the splitting machine is at fault, caused by the harder pull of an impatient workman. This will turn the hide a little and cause it to bag.

FRENCH LAMP COVER.

This cover is specially suitable for use with motor car lamps to protect them from dust and mud. Mole-skin or water-proof cloth is the material employed, the opening being behind to enable the cover to slip easily over the lamp, the aperture being closed by means of a pair of press buttons. A row of eyelets is

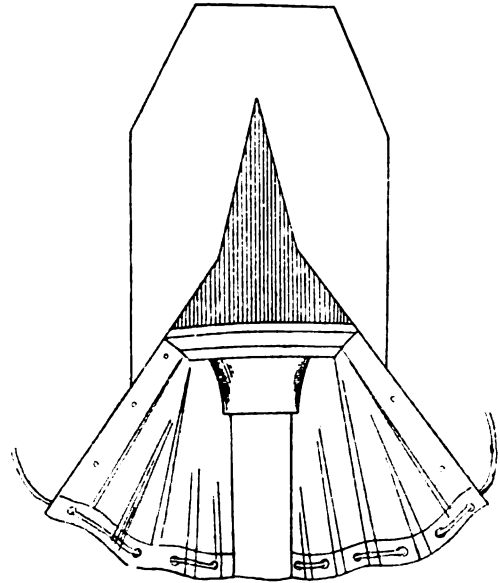

inserted along the bottom edge, through which a cord is passed. On the latter being drawn tight and fastened by a bow the cover is firmly secured in its place. A similar cover can be made for ordinary carriage lamps, the japanned and plated work of which is liable to suffer from road dust or from damp while in the coach house.

WAGON LUMBER FOR EXPORT.

The annual meeting of the American Wagon Oak Plank Association was attended by a large number of exporters and other prominent lumbermen.

The lumbermen met to consider the inspection rules submitted by the Timber Trade Association of Liverpool, governing the inspection of wagon oak plank to be shipped to the United Kingdom. The plan of the association is to eliminate as much as possible, the promiscuous shipping of irregular quality and undesirable dimensions of lumber to be used in the manufacture of wagons.

The association was organized in Roanoke a year ago. Among the prominent lumbermen at the Roanoke meeting were: J. C. Mayhew, of the W. M. Ritter Lumber Company, of Columbus, Ohio; Richard W. Price, of Price & Heald, Baltimore; John L. Alcock, of the John L. Alcock Lumber Company, of Baltimore; W. O. Price, the Baltimore hardwood merchant; W. C. Clement, of Greensboro, N. C.; Edward Barber, of Elingworth, Ingram and Company, Cincinnati, and others.

LOOKING FOR NEW FIELD.

The Baltimore Wheel Factory, otherwise known as the Edward Stinson Manufacturing Co., of Baltimore, Md., has just written to Secretary Clay of the Commercial Club, asking for full particulars regarding an idle wood-working plant located in Lexington, Ky.

"FROM TREE TO TIRE."

A spool of photographic film, projected on a square canvas from a moving picture machine, at first only amused, flippantly, then seriously, but now it has taken a more impressive place. There is unhesitating recognition of its value as a medium for educative publicity. And publicity that has educative or news value, something that tells a story, not only compels attention, but convinces with its candor.

The use of the photographic film has been accepted by some of the largest advertisers in this country to set forth their wares in a way that will not only advertise but also educate. A recent striking instance is a project undertaken by the B. F. Goodrich Company, Akron, Ohio. There is scarcely any commodity among the necessities about which so little is popularly known as rubber, and perhaps there is no article of commercial convenience, the construction and maintenance of which is so misunderstood as the automobile tire. Therefore, the nature of rubber, the difficulties of gathering it, the form of shipment, its transformation from the crude into the rubber of manufacture, and the actual making of an automobile tire, for example, are matters of educational concern.

The B. F. Goodrich Company has recognized this situation uniquely. At large expense it had taken a series of pictures representing the entire process "From Tree to Tire;" then it engaged the services of a lecturer and operator to show these views, and now it is placing the pictures before the members of automobile, athletic, and university clubs, and in public gatherings before every automobile owner in the country.

The first of these films shows the dense vegetation of the upriver regions of the Para, a tributary of the Amazon River, in South America. The native gatherer is seen making hatchet incisions into the bark of the rubber tree and then adjusting the cup to catch the latex. Other natives bring their calabashes, remove the cups from the trees, empty them of the juice, and emerge from the forest to the rubber camp.

There, underneath the thatched roof of an open hut, is a native dipping a heavy paddle into the sticky rubber and smoking it in the fumes of a fire built of palm nuts. This is the making of the rubber into convenient form for shipment—the large "biscuits" to be packed in wooden cases. Then there is a picture of the arrival of a shipment of "biscuits" and their storage in the large cellars of The B. F. Goodrich Company, Akron, O.

After that, are the steps of manufacture. First, the "biscuits" are weighed and inspected, and then softened so that the rubber can be well broken up and washed. Next is the important milling process—what might be called the kneading in a bakery—to mix the crude rubber with the various compounds; the coating of the fabric with rubber; and the cutting of the stock into various sizes to make up the Goodrich White Tough Tread. One of the most interesting series is the building of the tire on the tire machine, and then the significant process of applying the tread. After that is the vulcanizing of the tire, and its trimming and scrubbing.

One other feature of an automobile tire, the inner tube, is shown in the making and then the steps "From Tree to Tire" are completed.

These views are handled by an experienced operator and their significance is explained at length by a lecturer. The undertaking has met with unusually enthusiastic receptions. In Toledo recently one of the largest city theaters was hired by The B. F. Goodrich Company, and invitations were mailed by the company to every automobile owner in the city. Over 1,600 people responded. That evening the entire entertainment was referred to as an event of unusual moment in the field of educative publicity.

Mr. Tillisch, the lecturer, with the operator is now working towards the eastern cities and after this circuit is completed other sections of the country are to be visited.

Joseph Kelley, for 31 years foreman of the malleable foundry of the Moline (Ill.) Wagon Company's plant, has resigned.

A VERY UNUSUAL RECORD.

Phineas Jones & Co., whose wheels are like a good man's character, without blemish, make a remarkable statement which we deem interesting enough to repeat in full.

In these times when we read of strikes and disturbances between labor and capital, the service record shown below is remarkable. Phineas Jones & Co., the well known wheel manufacturers, began business in 1855, 55 years ago, and they have two men that are yet with them, with a record of 52 years, S. D. Aspinwall, in 1858 to date, also Edward Whalen, same date. The minimum service herein is 25 years. A few of these men were in the war of the Rebellion. Ira J. Smith, on his discharge from the war, came to the office and said, "Mr. Jones, I am through with the war and would like to work for you again." "Why man alive," replied Mr. Jones, the founder of the house, "haven't you been working for me the last five years? Go to work," and he did at once. The record is one to be proud of from the viewpoints, both of the employee and employer. Another noteworthy fact is that the concern has been in its present locality, 301 to 313 Market street, since 1864, a term of 46 years, during which time many changes have taken place in the vehicle business. This roster of workers and years of service is something to be proud of:

| | | |
|------------------|------------|--------------------------|
| S. D. Aspinwall | 1858 | 52 years. |
| Edward Whalen | ... 1858 | 52 years. |
| Ira J. Smith | 1858 | Died 1909 ... 51 years. |
| Michael Whalen | ... 1857 | Retired 1905 . 48 years. |
| Horace Day | 1860 | Retired 1908 . 48 years. |
| John Keller | 1865 | 45 years. |
| Patrick Whalen | ... 1865 | 45 years. |
| William Martin | ... 1868 | 42 years. |
| Charles Brown | 1868 | Died 1908 ... 40 years. |
| Calvin Smith | 1870 | 40 years. |
| Isaac Fort | 1867 | Died 1906 ... 39 years. |
| George Bagley | 1869 | Died 1908 .. 39 years. |
| James Looker | 1871 | 39 years. |
| Theodore Hoffman | 1876 | 34 years. |
| Charles Mott | 1868 | Retired 1902 . 34 years. |
| Jacob Losey | 1878 | 32 years. |
| John Rossnagle | 1878 | 32 years. |
| Mortimer Jaques | .. 1880 | 30 years. |
| Eugene Fulton | 1880 | 30 years. |
| Alfred Herdman | ... 1880 | 30 years. |
| Edward Day | 1880 | 30 years. |
| Israel Gant | 1870 | Died 1900 ... 30 years. |
| James Griffith | 1881 | 29 years. |
| James A. Day | 1866 | Retired 1894 . 28 years. |
| J. F. Bird, Jr. | 1883 | 27 years. |
| Aaron Cramer | 1883 | 27 years. |
| Edward Meeker | 1867 | Died 1892 ... 26 years. |
| Isaac Van Hart | 1868 | Retired 1894 . 26 years. |
| Henry Guerin | 1880 | Died 1905 ... 25 years. |
| Moses Sigler | 1860 | Died 1885 .. 25 years. |
| Robert Martin | 1866 | Died 1891 .. 25 years. |
| Louis Foell, Jr. | 1885 | 25 years. |
| Silas L. Hazen | 1875 | Retired 1900 . 25 years. |

THE STIVERS FACTORY TO BE A GARAGE.

The C. & G. Auto Company, of No. 312 West Forty-third Street, New York City, has acquired the carriage manufactory of R. M. Stivers, at Nos. 19 and 21 West Sixty-second street, for use as a garage. The property runs through to Sixty-third street and adjoins the New Theatre. It was reported also that the Maxwell-Briscoe Motor Company had made an offer for the Tichenor-Grand sales stables and riding academy which is on the opposite side of the street from the Stivers building in West Sixty-second street.

CHANCE FOR WHEEL FACTORY.

An effort is being made to start a wheel factory at York, Ala., as the location will be given free, whereas other places want several thousand dollars for a building site. Some northern capitalists are interested and will go over the grounds and talk with the people.

SUITABLE TIMBER FOR MOTOR BODIES.

The timber suitable for use in body building as adapted to motor cars is the subject of an article by G. W. in *The (London) Motor*. Some of the conclusions may be excepted to, but the ideas are a contribution to the thought of the subject that will excite more and better thought by others. Everything helps.

The employment of metals, aluminum and steel panels, does not appeal to the ordinary individual as do fine timbers either in the constructional or decorative parts. In no country can there be found any timber which approaches the English ash in value for the purpose to which it has been put in the construction of vehicles. Commercially, the ash has been grown for some hundreds of years, chiefly for conversion into vehicles of all descriptions.

The oak is too heavy, and requires a greater length of time to season. It was found, by experimental use, that ash, when seasoned did not cast or warp after working, and that exposure to the air did not affect it as elm, for instance, is affected. A screen of elm is in existence in an Elizabethan mansion which is a perfectly marvellous example of how timber can twist and warp after being worked up and built into a structure.

During the last century examination by scientific test and observation was made of the various qualities of English and foreign grown timbers, and of these dry ash is placed amongst the best for tensile and transverse strength, combined with lightness. And it is these qualities, combined with reasonable ease in working, which make it so very valuable for the framework of vehicles. The absence of a liability to twist or warp where doors and moving parts are concerned is also a quality which renders it very serviceable to the worker in the wood. The best ash, seasoned by being kept in a dry atmosphere, protected from the weather, but not at a uniform temperature, is used by the motor carriage builders for the best class of work.

Stocks of ash are frequently kept for seven to ten years, when considerable thickness is required, and as the timber becomes lighter the more thoroughly it is seasoned, there is also that advantage where timber which has been long in stock is used. A difference of 7 pounds per cubic foot has been noticed in the same class of timber between "commercially dry" and "bone dry" timbers. The advantage of using this specially seasoned timber is to be seen in the framing of vehicles which have been built of it, none of the various jointings of the framing, which cannot in every case be covered up by panelling, showing where the cross and longitudinal timbers meet. Elm is very seldom used, for the reason previously given; it has been used for parts of carriages where it is completely panelled over and protected from water. Of the imported timbers, Canadian birch and yellow pine and Honduras mahogany are the principle ones. Birch is suitable for what are known as "boot sides" and "rocker panels," and can easily and permanently be bent to even curves. It is not difficult to work, does not warp (if the proper kind is selected) and will retain a firm hold on screws and nails—a very important matter. Further, it is not readily affected by damp or water.

The Canadian yellow pine has been extensively used in vehicle building, for casings, roof, floor, seat boards, and under panels. For the roofs of motor carriages it is being superseded by "three-ply boards." These are a combination of sometimes two or three timbers or of one kind. The boards are composed of thin sheets of various suitable timbers; basswood, whitewood, birch, and mahogany have been used, the two latter as facing boards for the exposed side. These timbers are cut off the log very much like a roll of paper is unrolled, and are about one-sixteenth of an inch in thickness; three of these sheets, one at right angles to the others, are glued together, preferably with waterproof glue or cement, and thus a thin sheet of fine figured birch or mahogany can be glued to two pieces of some less valuable timber and make a very strong and comparatively light panel suitable for roofs. This method has been adopted for some

thicker boards used as bottom boards, which have to be left loose, so that gearboxes, etc., can be reached.

An Australian timber, Kauri pine, has been found to be very serviceable for this purpose, as it is not so liable to warp or be destroyed by oil, water, etc., which lodges on the underneath sides of all cars.

The three-ply roofing is almost universally used for roofs which have to carry luggage, the underside being painted or polished, at discretion. A fine effect is sometimes obtained by the use of the figured birch three-ply as a ceiling for the canopy and inside of limousines. A timber of contrasting color, such as walnut or mahogany, can be employed as a decorative moulding with fine effect.

The Honduras mahogany used in vehicle construction is quite different in character to the Cuban or Spanish mahogany used in furniture and for house decoration. It is lighter than ash, but the transverse strength is not so great. For panels, whether to be flat or bent, it is unequalled, as it is of fine, even texture, and of straight grain. It stays permanently where it is fixed if thoroughly seasoned when used in construction. These qualities, when the timber is used in conjunction with ash, make it invaluable for motor carriage construction, and as it can be dressed down to a uniform thickness of three-sixteenths of an inch, equal to some 64 square feet super., 35 lb. of mahogany panel will go a long way in covering framework.

A timber which is extensively used in America and is sometimes employed over here for interior casings, which have to be covered with upholstery, and for the cheaper qualities of work, is known as whitewood. This timber was introduced into England about 40 years ago, and was offered in very large logs, cutting panels sometimes 40 inches in width.

It was largely used in vehicle construction when the natural grain of the wood was desired to be shown, but a few years experience revealed very serious defects; it was easily and adversely affected by damp and water and readily became discolored, and is now very seldom used for this purpose, inside boards and seats being the extent to which carriage builders employ it. As the demand for it fell off and the supply on the Atlantic was absorbed by the American carriage builders, who have largely employed it in motor car body construction, the best qualities have not been imported, and only the tops of the trees and a comparatively few boards now come to this country.

Basswood is sometimes used for minor purposes, but red deal and pine are generally employed for step boards and similar work.

For interior decorations, Hungarian ash, pollard, oak-maple, walnut, figured mahogany, and other woods for contrast, such as satin wood and ebony, are now frequently employed in the decoration of the interior of cars. This is a distinct advance, for there is no necessity for the whole of an interior to be upholstered, and the ceiling and upper parts of a closed carriage may, with advantage from a sanitary as much as an esthetic point of view, be fitted with material which can be cleaned easily and thoroughly without its being stained or destroyed.

In the early days of the horse-drawn carriage, when it had been developed into, for that time, a luxurious mode of transit, the artist was called in to employ his art upon the decoration of the interior. To-day we desire the help of the worker in fine woods, who seeks, by skillful arrangement, and the combination of light and shade, relief to the artistic sense from straight lines and flat surfaces, which, while they are essential in construction, are not always strictly pleasing in effect.

CARRIAGE WORKERS STRIKE.

About twenty-five members of the Gray & Sons' Carriage Works, Chatham, Canada, went out on strike March 18. The men struck for increased wages on night work. The factory has been running overtime, and the men wanted time and a half for the extra work. The strikers were the crate workers and the iron seat workers.

CONCERNING THE SELDEN PATENT.

In Case and Comment the legal aspects of the Selden patent are commented upon in a manner that the layman can understand, and we give below the findings of the writer of the article as a subject of current interest:

A new departure seems to have been taken in upholding the Selden patent on automobiles. The court says that no litigation closely resembling the case has been shown to it, and it cites no authority for its holding, so that it seems that the court itself recognizes that it is treading on new ground. The claim of the patent is for the combination with a road locomotive provided with suitable running gear, including a propelling wheel and steering mechanism, of a liquid hydro-carbon gas engine of the compression type, comprising one or more power cylinders, a suitable liquid fuel receptacle, a power shaft connected with, and arranged to run faster than, the propelling wheel, in intermediate clutch or disconnecting device, and a suitable carriage body adapted to the conveyance of persons or goods, substantially as described." This, of course, is a mere claim for combination of several parts, all of which were old at the time, and it would seem that, if any patent for it could be sustained, then any application of power to the operation of any machine is subject to patent. In fact, although the claim is for a combination, when changed in form and reduced to its ultimate terms, it is merely a claim for the application of power in the shape of a gas engine to the running of a road vehicle. Such a claim has never been thought to be patentable. In fact, the court says, in referring to a machine manufactured by Rosenwald, that even if it had been successful, he might, nevertheless, have found his patent invalid by American law, because each part of his vehicle was doing just what it had always done without any new "co-operative law," while his engine, in particular, was the same motor which, before it was applied to his brougham, had, perchance, driven a lathe, and might to-morrow do something else. On the face of Selden's claim, that is precisely what he did, and that would make his patent unsustainable. The court says that there is no denial that, in form, nothing but combination was claimed. But then comes the point of the decision, which seems to be in advance of the former law.

The court says that Selden's combination cannot be taken apart and each element recognized as something that had done the same thing or series of things before. It then proceeds to show that he took the old Brayton engine and made some alterations in it. He built a plurality of cylinders to minimize the necessity for a flywheel; he produced an inclosed crankcase, and used a small piston with a short stroke. By so doing, he devised and used an arrangement of Brayton's engine never before attempted—one that Brayton himself never suggested, made, or patented, and without which the road vehicle was an impossibility. So that, in 1879, when Selden applied for his patent, there was not one gas engine, which, in its then form, could be made an element in a road wagon combination. The court further says Selden solved this difficulty, and such solution gave him the right to claim broadly the thing which was the leading element in his invention when used in his combination. But he did not claim it. What he had invented was an improvement on the gas engine, but there is nowhere in his claim any mention of such improvement. What he claims is the combination, and that alone; and, so far as appears from his papers, the elements of his combination are all old and well known. There is no suggestion that he made an improved engine, and sought a patent on that, and the question then arises whether one can invent a part of a combination, and then, without mentioning or claiming his invention, simply make it an element of his combination, treating it as an old device, and when he secures a patent on his combination, shut others out of the use of the device which he has not claimed. Such does not seem to have been understood to be the law; and, from the fact that no precedents could be found, the holding that it can be done would seem to be a new departure in patent law. If the engine was in fact the old, well known

engine, the court itself, as above shown, says the combination would be invalid. Does the fact that the engine was in fact new alter the case when Selden treats it as old, and makes no claim for it? Prima facie it would seem that, by reason of the fact that he abandoned his claim on it, so that it at once became public property, it would fall under the well established rule which applies in any case of a mere application of power to the operation of machinery. From the opinion, the question of the sufficiency of the claim to cover this invention does not seem to have been considered by counsel, but they seem to have confined their attention to the question of whether or not Selden had a practicable working model when his application was filed, and whether or not defendant's machines infringed the patent. It is understood that the case will be appealed, and the question of the possibility of excluding the public from the use of a new device by simply claiming it as part of a combination may be presented to the consideration of the Appellate Court. If the device can be covered in that way, an interesting question arises as to the scope of the patent. The adaptation of the gas engine used by Selden in his automobile is practically the same as that used in motor boats, aeroplanes, and for other purposes; and, if that is Selden's invention, the question arises: Can he recover royalty for the use of it in all ways in which it is now used?

BEDROCK PATENTS.

The Chronicle, of Pawtucket, R. I., says editorially that: It may be a question whether the United States patent system does more good than harm. More patents are granted to the citizens of the United States by our government than are granted to all the subjects of all European powers by their sovereign authorities. Much is said about basic or bedrock patents at this time, and it is probable that we will soon have an aeroplane trust, just as we have a telephone trust, and an automobile trust. There should be no such thing as a basic patent. Such a patent was granted to Alexander Graham Bell. The Patent Office is more careful now, and will not grant such broad protective claims as were granted to Bell, making it possible to establish a telephone trust, which now, after the expiration of the patent, is the basis of a more grinding monopoly than during the seventeen years for which the patent was granted. Look again at the Selden patent recently upheld by the courts. Gas engines were old twenty years ago. Wheels have been old for at least 5,000 years. Recently a very perfect wheeled vehicle was taken from an Egyptian tomb that antedated the Christian era by at least 5,000 years. Nevertheless, the Selden patent which has been sustained by the courts is little more than putting a gas engine on wheels.

PERSONALS.

Fifty-one years ago Alderman U. J. Albertsen started in as an apprentice in the painting department at the Smith Wagon Works, Pekin, Ill., and he served an apprenticeship of three years in the concern of which he is now superintendent.

Frank M. Allen, for years superintendent of the Freeport Carriage Co., Freeport, Ill., a branch of the Moline Plow Co., has resigned his position.

Announcement is made that Mr. Joseph Wright, Jr., who has been engaged in the livery business in Winchester, Va., for a number of years, has accepted the position of southern representative of the Columbus Buggy Company.

Frank Wisner has accepted a position with the Newark (N.Y.) Wagon Works.

ADDED AUTOMOBILE HARDWARE.

John A. Gifford & Son, the old established jobbers of carriage material at 25 Park Place, New York City, have added to stock a very complete line of automobile hardware, trimmings and forgings, all of which have been catalogued for use of customers and the catalogues may now be had on application.

OBITUARY

John Louis Hurd Mosier died in Bellevue Hospital in New York City on March 16. He had gone to the hospital to submit to a surgical operation that was not deemed to be dangerous. He succumbed to shock unexpectedly. He was in his 77th year. Mr. Mosier leaves a widow, two sons and three daughters, one of the latter adopted. The funeral, very largely attended by representatives of the carriage building industry, was from 50 Great Jones Street.

Mr. Mosier was born at Derby Line, Vt., of old New England stock. He was of French extraction on the male side, while his mother was an English woman.

In 1850 he apprenticed himself to H. Monee in New York City to learn the trade of carriage smithing. In 1860 he went to



John Louis Hurd Mosier.

South Carolina to become superintendent of a carriage shop. As these were times of trouble he had his, to the extent of being sentenced to be hung as an abolitionist. He escaped execution, and fled the country, returning to New York.

In 1865 he was offered the position of finisher in the Brewster factory. His advance was rapid, soon becoming superintendent of the heavy work department in the smith shop. When he resigned in 1892 he was at the head of the department, after a continuous service of 29 years with this firm.

He made up for the lack of early educational advantages by great application, and his development as a technical writer on technical subjects began with his contributions to *The Hub*, and his very latest contributions appeared in the same pages.

He was inventive and fertile in ideas of practical use, and they are a testimonial to his ability to this day in the trade. He organized and conducted the noon-day class for apprentices, doing a fine work in his chosen field. He was honored in many ways and in many fields, having received diplomas at home and abroad. He was a linguist of some merit, and one of the best of companions, excelling as a story teller.

His death removes one more of the landmarks of the old regime, that seems to be so near to the close of its cycle. His name and fame extended much beyond the personal bounds of

his influence, and throughout the trade numbers will learn with deep regret that he has passed away.

Charles J. Wheeler died in Wellsboro, N. Y., February 4. He was born April 30, 1837, in Delaware County, N. Y., and spent the early part of his life in Lawrenceville and Tioga. In 1865 he moved to Wellsboro and engaged in the carriage business. Of late years he had conducted a wagon repair shop and at the time of his death he was Wellsboro's oldest resident engaged in active business. Mr. Wheeler is survived by a widow and two children.

George W. Wetherhold, a member of the firm of Wetherhold Bros., carriage manufacturers, Reading, Pa., died of Bright's disease on February 10. The deceased had since 1891 been engaged in the manufacture of carriages with his brother, William W. Wetherhold. Mr. Wetherhold was forty-six years of age, and up to about three weeks before his death had enjoyed good health. A widow and three children survive him.

Colonel Samuel K. Herr, Westminster, Md., died February 14 after a brief illness. Going to Westminster at the close of the war, with his brother, Frank K. Herr, he established the carriage factory of Herr Bros. Some years ago he retired from the firm and was succeeded by a Mr. Bahglan, the firm now being Herr & Bahglan. The deceased is survived by his widow, one brother and three sisters.

Thomas Buckland Jeffery, inventor of the clincher pneumatic tire and head of the Thomas B. Jeffery Company, died suddenly in Pompeii, Italy, April 2d. Mr. Jeffery was touring Europe with his wife. He is survived by two sons, Charles T. and Harold W. Jeffery, both of Kenosha, and two daughters, Mrs. A. R. Carqueville, of Chicago, and Mrs. Hudson, of St. Louis. Mr. Jeffery was born in England in 1845, came to this country in 1863 and settled in Chicago. For more than twenty-five years he was a partner in the firm of Gormully and Jeffery, makers of bicycles. He was several times a millionaire. The body will be brought to America for burial.

George Norman Pierce, father of the Pierce-Arrow car and one of the founders of the Pierce-Arrow Motor Car Company, was buried March 26 in Forest Lawn. Mr. Pierce died of heart disease. He was born in Friendsville, near Waverly, N. Y., 64 years ago and received his education in the public schools and a business college. He married Miss Louisa H. Day, of Boston, by whom he is survived, together with eight children.

He began business in Buffalo as a member of the firm of Heintz, Pierce & Munschauer, making refrigerators and bird cages in 1872. From this, the firm diverged into the making of bicycles and tricycles on Hanover street when the bicycle craze swept the world. The motor car began to occupy Mr. Pierce's attention in 1898, work being carried on in the Hanover street plant until 1907.

Joseph A. Briscoe, one of the pioneers in the manufacturing line at Detroit, died March 25 after an attack of heart disease.

Mr. Briscoe was the father of Benjamin Briscoe, president of the United States Motor Company, and Frank Briscoe, president of the Brush Runabout Company. He was treasurer of the Briscoe Manufacturing Company, of Detroit, although for the past two years he had not been actively engaged in business.

He was 72 years of age. He was the first engineer to take a locomotive into Detroit and has always been identified with engineering and machinery.

He was born at Philadelphia and removed to Detroit when an infant, spending practically his whole life in the Michigan metropolis. In his youth, Mr. Briscoe invented a machine for making nuts and bolts and was one of the founders of the Michigan Bolt and Nut Works, which is still in existence.

J. C. Ziegler, 77 years old, a pioneer and well known resident of South Bend, Ind., an official of the Studebaker Wagon Company, dropped dead in the LaSalle Street depot, Chicago, as he stepped from a train. Mr. Ziegler is believed to have died of heart disease combined with old age.

Harry G. Hamilton, general manager of the Rapid Motor Vehicle Co., and director in the General Motors Co., died at his

residence in Pontiac, Mich., from acute Bright's disease. His severe illness extended over a period of about one week, although his affliction was a recurrence of previous serious attacks from the same disease. He was born at Rochester, N. Y., November 3, 1861. He leaves a widow.

Charles O. Frost, of Kenosha, Wis., formerly president of the Badger Brass Manufacturing Company, and president of the Frost Manufacturing Company, died February 27, at the age of 66. Mr. Frost had been connected with the brass industry in the United States for nearly fifty years.

Peter Walker died March 27 at his son's house in New York City. He was taken to Chatham, N. Y., for interment. He conducted a carriage business for many years in Chatham. He is survived by a son and daughter.

Michael Meegan, a retired wagon manufacturer of New York City, died of nephritis at his home, 173 North Eighth Street, Brooklyn, aged 75 years. He left four sons and two daughters.

George H. Alling, president of a rubber company, was instantly killed at the plant in Barbarton, March 24. His clothing was caught in a machine and he was crushed to death.

John Henry Huy died at his home in Pittsburg, Pa., aged 59. He is survived by a widow and six children. He was a well known wagon builder.

LARGER WHEELS, LARGER TIRES.

If anyone doubts the increasing popularity of large wheels and tires over the smaller sizes, he may have his doubts quickly dispelled by comparing the equipment carried by 1910 cars with the tires and wheels on automobiles now three or four years old.

Only three years ago, says a prominent tire manufacturer, 30 and 32-inch tires were the rule and a 34x4 was considered exceptionally large. Now the 36 and 38 inch tires are popular sizes for similar cars and even 42 inch tires have become standard equipment on half a dozen makes of automobiles, with more announced for the future. The reason is that larger tires contribute to economy in mileage cost and to comfort in riding.

Compare the service received from a 30-inch tire with that from a 38-inch one on a car of similar capacity. The larger tire will invariably stand harder usage and for a vastly greater period of time. On rutty roads the former will drop into holes that the larger tire will ride over with ease. The hub of the 30-inch wheel being four inches lower than the hub of the 38-inch, the resistance of road obstacles which would be a severe shock to the momentum of the first car and a discomfiting jar to its passengers, is passed over almost unnoticed by the larger wheel.

In a smaller degree the outward curve of the 30-inch tire being greater than that of the 38-inch, a less abrupt bending of the fabric invariably follows a shock to the latter. The strain exerted on the tread of the larger tire when the car is in motion is divided over a larger area of road contact and is less tense at any one spot, at the same time affording better traction. This strain is also distributed around a greater circumference, thus conserving the strength of the tire. Any given point of the tread of the larger tire touches the ground less frequently in a given distance. This means less wear at any point, and also a more perfect radiation of the heat generated by friction. Heat is one of the most destructive elements to tires.

Abstract as these facts may appear, they are the main influences which combine to affect the wearing and riding qualities of a tire.

REFUSED A CHARTER.

Local No. 6, International Union of Carriage and Wagon Workers, San Francisco, was informed at its last meeting that "the efforts of a few disgruntled former members of the union to obtain a charter for a union of carriage painters had been effectually blocked, as the international union had sent word that no local charter would be granted so long as the carriage painters were affiliated with No. 6."

AN OWNER'S IDEAS ABOUT BODIES.

As some of the most practical and valuable suggestions have come to carriage builders by owners who think as they ride—notably doctors—the illustration of a body that strikes an owner as a good idea is shown and described as a suggestion:

I suppose we all have our special ideas in regard to car bodies as in other things, and I beg to submit a suggestion which may meet the requirements of certain motorists who always drive their own cars. The idea is to have (1) accommodation for four, if necessary, and that with a fair amount of comfort; (2) body as light as possible as the car is generally used for one or two only; (3) a car readily closed in—practically draught-proof—without the trouble connected with the usual four-seaters, Cape cart hood, intermediate screen, etc., although one

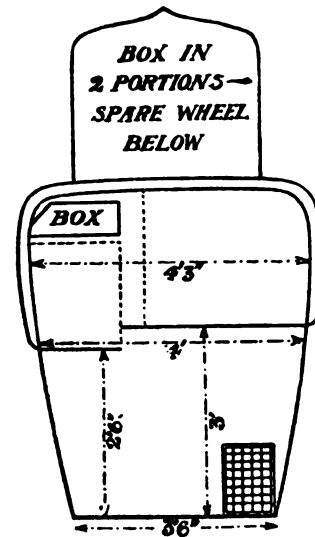

might not get entirely out of the difficulty of buttoning on one curtain on each side. I send you a rough sketch of this body, with dimensions marked. One difficulty seems to be that, owing to the unusual width of body, the centre of the steering wheel in the ordinary chassis would be about 6 inches from the centre of the driver's seat, as shown; but, as the car is only occasionally required to accommodate four, it is proposed to put up with this inconvenience, and on other occasions to slide the driver's seat 6 inches to the left, by making that width of cushion at his side adjustable. With a good rake on the steering pillar and the seat set low, the ordinary length of pillar may suit, and for a tall person, at least, it would be an advantage in most cars to get further from the dash. A small folding seat is fitted 8' the left near the glass screen, as I should not care to adopt the folding back seat occasionally fixed to "two seaters."

THE SCHUBERT BODIES.

The Schubert Bros. Gear Co., of Oneida, N. Y., have long been well known as makers and designers of most excellent vehicle bodies. As the demand from the automobile fraternity has grown the company has met it with designs in limousine, taxi, touring and roadster bodies in either metal or wood as ordered, yet their usual body work is prosecuted just the same. The styles number upwards of fifty, and gears, seats and tops are not by any means neglected.

DUE TO ORGANIZATION.

The secretary of the National Association of Agricultural Implement and Vehicle Manufacturers, W. J. Evans, of Chicago, says: "The harmonious working of the shippers and the carriers is becoming more pronounced every day." And to what does he attribute it—To the laws! Not at all. He adds: "I believe this better feeling is due very largely to the fact that the shippers deal with the carriers through their organizations."

Trade News From Near and Far

NEW FIRMS AND INCORPORATIONS.

F. E. Saiter will open a new buggy and harness store at Vincennes, Ind.

The Mutchler Company, a corporation, organized for the manufacture of implements and the Mills adjustable wagon bed, has been organized at Goshen, Ind. The personnel of the Mutchler Company is the same as that of the I-XL Furniture Company.

C. L. Reed & Co., have established a wagon and buggy factory at Wichita, Kan., where they are manufacturing both light and heavy vehicles.

The Johnston Automobile Co., of Marshalltown, Ia., has just perfected the manufacture of a new motor for automobiles, and if tests are satisfactory the company will assemble automobiles, equipping them with the new motor.

E. Armacost, Baltimore, Md., has established a repository at 1710 Frederick Avenue.

Wolf & McAlly, Waynesboro, Pa., have opened a carriage paint shop.

Ely & Siebrecht, Lexington, Ky., have established a repository.

Murlehof Mfg. Co., Lockport, N. Y., has begun the manufacture of automobile accessories.

The Schurnier Motor Car Co. is the name of a new company which will manufacture automobiles at St. Paul, Minn.

The Tuttle Motor Co., Canastota, N. Y., has begun to manufacture automobiles, etc.

William Selle, Dayton, Wash., has begun making carriages and wagons.

A. A. King, Westfield, N. J., has opened a carriage paint shop.

S. A. Green, Chickasha, Okla., has opened a carriage paint shop.

Double Fabric Tire Co., Auburn, Ohio, capital \$10,000. Incorporators W. H. and V. I. Willinor, A. L. and L. H. Murray.

Frank Stouffer, Lurgan, Pa., has opened a carriage shop.

The Indestructible Wheel Co., Lebanon, Ind., has been incorporated, capital \$15,000.

At Aberdeen, S. D., the Union Implement & Transfer Co., implements, autos, etc., has been incorporated; capital, \$50,000.

At Minneapolis, Minn., the Electric Vehicle Co. has been incorporated; capital, \$20,000.

P. H. Graves has engaged in the implement and vehicle business at Gruver, Iowa.

Pingel & Schneitzer, Stockbridge, Wis., have engaged in the vehicle and implement business.

The Peterson Implement Co., Litchfield, Minn., implements and vehicles, has been incorporated; capital, \$25,000.

At Cleveland, Ohio, the Broc Electric Vehicle Co. has incorporated; capital, \$250,000.

Ramsey County Implement Co., Devil's Lake, N. D., vehicles, implements, etc., has been incorporated; capital, \$10,000.

The Stanley (N. D.) Implement Co., implements and vehicles, has been incorporated; capital, \$20,000.

The Pike Gate Co., Pittsfield, Ill., manufacturers of gates, fences, vehicles, etc., has been incorporated; capital, \$50,000.

The Seventy-Nine Mercantile Co., has engaged in the vehicle and implement business at Seventy-nine, Mont.

E. C. Good has engaged in the vehicle and implement business at Browntown, Wis.

Hubbard and Baily, Fort Atkinson, Wis., will engage in the implement and vehicle business.

Machinery of the Clinton Wagon Stock Co., Clinton, Mo.,

has been placed, and the work of manufacture of wagon material begun with a full force of men.

The Western Spring & Axle Company, of Wheeling, W. Va., capital stock, \$5,000,000, has been incorporated by George A. Laughlin, Frank C. Hoffman, Andrew Reitz.

The Queen City Wagon and Manufacturing Company, Meridian, Miss., is one of Meridian's latest industries. They manufacture log and lumber wagons.

P. C. and C. G. Sims, Ardmore, Okla., will engage in the buggy business as dealers.

E. E. Plank and Milton Wise, Butler, O., have formed a partnership for the purpose of engaging in the buggy business.

BUSINESS CHANGES.

Mr. Laysler, Millbach, Pa., has purchased the Fauber Coach Works in Lebanon, Pa.

Mr. Frank Eller Co., Houston, Tex., has changed its name to the Eller Wagon Works and increased its capital to \$20,000.

S. M. White & Co., Houston, Tex., succeed M. V. Anderson & Co.

Robert A. McCord has sold his interest in the Williams Wagon Works, at Macon, Ga., and will engage in the automobile business at Cordele, same state.

R. B. Fields has purchased a half interest in the City Blacksmith Shop at Chickasha, Okla., and will have control of the carriage department.

The Haywood Wagon Co. has moved its office from Baldwinville to Newark, N. Y.

The Baltimore Buggy Top Co., Baltimore, Md., has established a branch at 1313 New York Avenue, same city.

The Weyher Mfg. Co., Whitewater, Wis., manufacturing wagons, will re-incorporate as the Whitewater Mfg. Co.

Deering & Radtke, Zachow, Wis., vehicles, implements, has been succeeded by H. Radtke.

Tate & Kleinpell, Cassville, Wis., implements, vehicles and gas engines, advertise a closing out sale. They intend locating in Montana.

Stoughton Wholesale Commercial Co., Stoughton, Wis., vehicles and implements, has sold out to Emery & Johnson.

Bahr & Lee, Augusta, Wis., vehicles, implements, etc., have been succeeded by F. H. Bahr.

Otto Greenberg, Pardeeville, Wis., has sold his wagon shop to Carl Bennett.

E. C. Weckerly, Winslow, Ill., implements and vehicles, has sold a half interest to M. J. Vanmeter.

At Nevada, Ohio, R. S. Ulrich, carriage dealer, has formed a partnership with Jesse Dotts. The firm name will be Ulrich & Dotts.

The Jackson (Tenn.) Carriage Company, capital \$15,000, has been incorporated by S. H. Neff and others. The new company takes over the Franklin Carriage Company.

IMPROVEMENTS AND EXTENSIONS.

The Adams Patent Wheel Company, of Cassville, Wis., will have a branch factory at LaCrosse, Wis.

Peabody Buggy Co., Fostoria, O., will open a branch factory in Lexington, Ky.

The Michigan Distributing Co., Lansing, Mich., implements, vehicles, etc., has increased its capital from \$40,000 to \$60,000.

The Etoah Vehicle Manufacturing Company, Rome, Ga., announces that it will engage in the manufacture of high grade

buggies and vehicles, as well as turning out its former output of hose wagons, hose reel trucks, etc.

Work has been started in Fort Smith, Ark., on a two story brick addition to the plant of the Fort Smith Wagon Company, one of the Deere & Co., auxiliary concerns. The addition will cost \$25,000.

The N. C. Blanchard Company, of Spring City, Tenn., will begin the erection of a hub and spoke factory in Dalton, Ga. Mr. Coe announces that the operations will begin on a small scale, fifteen employes being required when they begin work, but if the enterprise is successful the capacity will be increased and more men employed.

The Ohio Carriage and Manufacturing Co., Columbus, Ohio, will enlarge its plant.

Brown Bros. Carriage Co., Bristol, Tenn., is enlarging its plant.

D. P. Nichols Carriage Co., Boston, Mass., has leased two buildings on West 47th Street, New York City, being part of the Brewster factory, now relinquished, in which a repository will be established.

Middletown Buggy Co., Middletown, Ohio, will occupy the plant of the late Decatur Buggy Co.

Studebaker Bros. Mfg. Co. has opened a branch in Meridan, Idaho.

Lamois Wagon Co., Greenville, Tenn., will start a branch factory at Bristol.

Nicholas Fox, Grand Rapids, Mich., is erecting an addition to his present premises to accommodate the buggy and implement business.

J. J. Karney Mfg. Co., Fitchburg, Mass., has established a branch carriage and wagon shop at Barre, Vt.

Bettendorf Axle Co., Davenport, Iowa, has extended its plant and moved to Bettendorf, a suburb of Davenport.

Reimund Bros., Findlay, Ohio, have added a new paint shop extension.

John K. Jerger, Reading, Pa., is moving his business to Sinking Spring, same state.

F. H. Johnson has bought the interest of L. H. Fitzgerald in the Johnson Carriage Co., at Riverside, Cal. Business will be enlarged.

The Farmer's Handy Wagon Co., Saginaw, Mich., has moved into a new office building.

Robertson & Doll, Denver, Colo., very large dealers, will move into new quarters on Lincoln street between Colfax and Sixteenth streets.

Burton & McCannon, Cambridge, Mass., have moved into new quarters at 227 Mount Auburn Street.

FIRES.

Fire did \$2,000 damage to the John Immel & Sons Carriage and Wagon Works at Columbus, Ohio.

Fire destroyed the Griffin Wheel Works in South Denver; loss, \$100,000.

The fire loss suffered by Hahn Bros., Reading, Pa., has caused them to move into temporary workshops in rear of late premises.

L. W. Stevens & Sons' large carriage shop at Caribou, Me., was damaged to the extent of about \$4,000 by fire. Covered by insurance.

Fire of uncertain origin destroyed the spring department of the Ansted Spring & Axle Works, at Connersville, Ind., causing a loss of \$75,000. The burned building was insured for \$20,000. It will be rebuilt.

A red hot piece of iron left by workmen in the William E. Hunt wagon and vehicle factory in South Bend, Ind., caused a \$25 fire loss.

Racine-Sattley Co., Racine, Wis., suffered loss of its Texas branch in Dallas, Texas. Estimated damage, \$5,000; fully covered.

Corbett Buggy Co., Henderson, N. C., lost two buildings by

fire, comprising woodwork and stock shops. Damage, \$60,000; fully covered.

C. Priebe Carriage Co., St. Joseph, Mo., suffered partial destruction of factory by fire. Loss about \$5,000, and fully covered.

ODDS AND ENDS.

By breaking of elevator cables in the Fuller Buggy Co. plant, Jackson, Mich., Fred Durese and Clayton Rutledge received injuries.

George T. Odell, of Consolidated Wagon and Machine Co., Salt Lake City, Utah, testified before the Interstate Commerce Commission at Washington in the matter of freight shipment rebates.

Mr. Ralph Dort, son of J. Dallas Dort, (Durant & Dort) must also have the speed mania, as he was fined recently for burning up the road in a Buick.

The St. Louis (Mo.) Implement, Vehicle and Hardware Association adopted resolutions pledging support to the Merchants and Manufacturers' Association, which recently was formed to work for the abolition of the bridge arbitrary.

In the suit of Edward Bell for injuries against the Bettendorf Axle Co., the decision of lower court has been affirmed. The claim is for \$5,000.

F. M. Allen, superintendent of the Freeport Carriage Company, Freeport, Ill., has resigned his position. The assistant superintendent, E. F. Tinney, will have charge of the factory.

The necessity of excellent automobile body building is discussed by Charles Rauch, president of the Rauch & Lang Carriage Company. For fifty-eight years, says Mr. Rauch, we have contended that bodies of vehicles demand unusual attention because a body is that part of a vehicle which meets the scrutiny of the exacting buyer.

BUSINESS TROUBLES.

H. H. Hines, receiver for New Decatur Buggy Co., Hamilton, Ohio, has received a bid of \$15,000 for the property. Property was finally sold to D. D. Bundy for \$15,200.

Voluntary petitions in bankruptcy were filed in Richmond, Va., in relation to the Ainslee Carriage Co.

The Ingle Wagon Co., Fort Smith, Ark., in in liquidation. Firm was established 75 years ago.

W. W. Baylor has been made receiver for Robinson & Baylor, Scranton, Pa.

RECENTLY EXPIRED PATENTS OF INTEREST TO CARRIAGE INDUSTRY.

Patents expired February 14, 1910.

491,790—Whiffletree Coupling. Cornelius Wilcox, Sunbury, O.
491,838—Safety Attachment for Vehicle Thills. Geo. Dippold, Brooklyn, N. Y.

Patents expired February 21, 1910.

491,983—Folding Buggy Top. Thomas P. Chamberlin, Fort Recovery, Ohio.
492,013—Vehicle Tongue. Wm. A. Hanna, Henry, Ill.
492,090—Wagon Body. Wm. K. Long and Charles H. Henry, Cleveland Ohio.

Patents expired February 28, 1910.

492,461—Carriage. John Currier and Frederick Ellis, Amesbury, Mass.
492,560—Whiffletree. James A. Scarborough and Carrol Bardwell, Wesson, Miss.

Patents expired March 7, 1910.

492,788—Vehicle Spring. Jas. N. Eastwood, Kansas City, Mo.
492,822—Tongue Support for Vehicles. Johnson McGinis, Emmenton, Pa.
492,984—Two Wheeled Vehicle. John F. Ketter, Ironton, O.
493,097—Hub for Vehicle Wheels. Louis C. Labady, Tacoma, Wash.

The above lists of patents, trade marks, and designs of interest to our patrons are furnished by Davis & Davis, solicitors of American and foreign patents, Washington, D. C., and St. Paul Building, New York City.

Recently Granted Carriage Patents

Brake Shoe. Otto A. Koenig, assignor to Koenig Wagon Company, Kansas City, Mo. No. 950,486. Patented March 1, 1910.

A combination with a brake bar, having a pair of bearing members with a squared holding section located between a brake

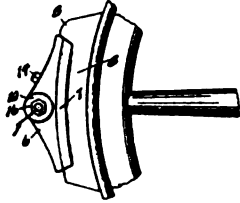

shoe, having a divided hub, the members of which are adapted for free revolution on the brake-bar bearing members, a holding member comprising a hub, having a squared channel adapted to fit over the squared holding section of brake bar, a shank on hub, and a set screw projecting through shank into engagement with the shoe body.

Thill Coupling. Frank A. Strodel, Syracuse, N. Y., assignor to Christopher C. Bradley, Sr., Syracuse, N. Y. No. 950,733. Patented March 1, 1910.

In a thill coupling, a coupling pin, two jaws, one of which is fixed and the other pivoted intermediate its ends to the fixed jaw, the jaws adapted to grasp and release the coupling pin, a

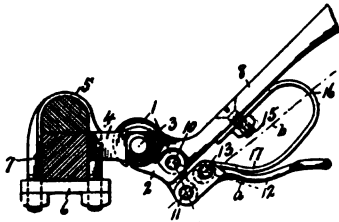

substantially U-shaped spring having a long and a short arm, the shorter arm being rigidly secured to the fixed jaw, a lever pivoted at its inner end to the outer end of the movable jaw and to which lever the free end of the longer arm of the spring is pivoted at a point removed from the inner end of the lever and the pivot between the movable jaw and lever, the longer arm of spring being curved inwardly at a point adjacent its pivoted end whereby when the lever is swung forwardly on its pivot toward the spring to close the jaws, the inwardly curved portion of the spring is compressed or caused to flex longitudinally of the arms of the spring.

Carriage Iron. Lewis Kuchenbecker, Waltham, Minn. No. 951,008. Patented March 10, 1910.

A carriage iron consisting of a one piece structure comprising parallel complementary inner and outer sections of angle forma-

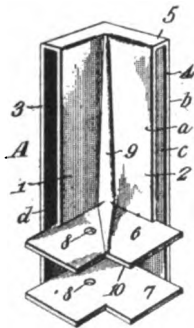

tion, a web uniting the upper ends of the sections, plates projected inward in spaced relation from the lower ends, a rib provided in the angle between the members of the inner section and extended across the upper side of the plate at the lower end of

inner section, the rib tapering from the angle toward its extremities.

Thill Coupling. Alfred H. Worrest, Lancaster, Pa., assignor to Metal Stamping Company, New York, N. Y. No. 952,025. Patented March 15, 1910.

A thill-coupling, comprising a bolt-engaging hook, a pivoted jaw, a lever, a bolt comprising relatively moveable members connected with the pivoted jaw and pivotally connected with the

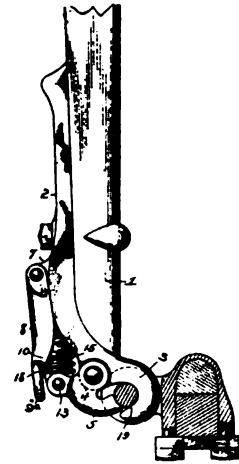

lever in such position that the pivotal connection with the lever can be moved beyond a line passing through the pivotal support of the lever and the pivotal connection of the rod or bolt with the jaw, and a spring encircling the rod or bolt between the lever and the pivoted jaw.

Mud-Guard Attachment. Joseph A. Sauer, Hamilton, Ohio. No. 952,144. Patented March 15, 1910.

An attachment comprising curved parallel bars pivoted to the under side of a mud guard at one of their ends, the free ends of bars having longitudinal slots formed therein, a transverse shaft

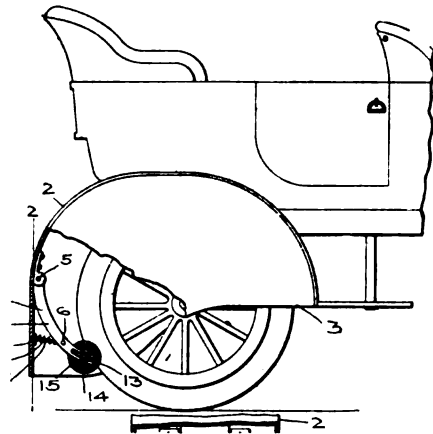

adjustably mounted in slots, means for securing the shaft in its adjusted position, a brush rotatably mounted on shaft, the periphery of brush being concave for engagement with the periphery of a vehicle wheel, a rod secured to the under side of guard and movable through the brace bar, a spring disposed between the brace bar and the mud guard upon rod adapted to tensionally hold the brush in contact with a vehicle wheel, and means carried by the rod to regulate the tension of spring.

Wind Shield. Henry B. Pitner, Dubois, Pa. No. 952,353. Patented March 15, 1910.

The combination of a wind shield having upper and lower sections, the lower section having its upper edge beveled down-

wardly and rearwardly, and the bottom edge of the upper section being correspondingly beveled, parallel link connections uniting the two sections at their ends whereby the upper section may swing downwardly and rearwardly against the rear face of the lower section, co-acting devices adjacent the ends of the two sections to engage each other when sections are superposed, a keeper at the center of the upper edge of the lower section,

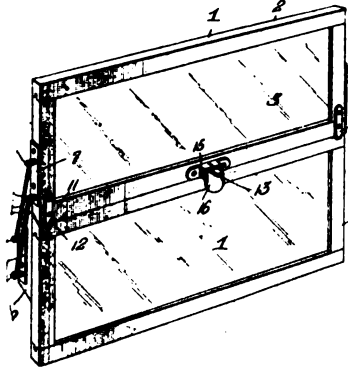

and a catch at the center of the bottom edge of the upper section to engage keeper and retain the sections in superposed position.

Hood for Use on Road Vehicles. Denis T. Brock, London, and Ezra Reeve, Bedford, England. No. 952,183. Patented March 15, 1910.

Hoods for road vehicles, the combination of a pair of adjacent bows connected together at each side by a link pivoted to

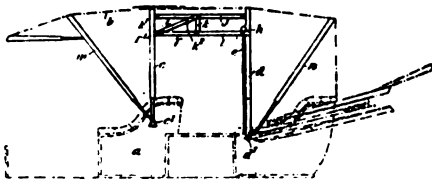

one bow and having a sliding connection with the other bow, of links which, together with the link, form a pair of parallel toggles connecting the bows together and of a link connecting the members of each pair of toggles together at their central joints.

Spare Wheel for Vehicles. Edward T. Burrowes, Portland, Me. No. 951,938. Patented March 15, 1910.

A spare wheel, in combination with a movable clamping member adapted to engage a part carried by the main wheel of a

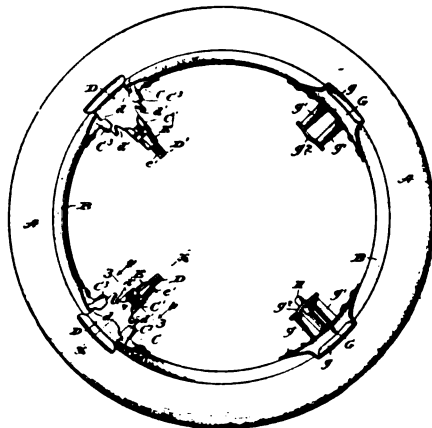

vehicle, and means associated therewith for securing the same to the main wheel independent of the clamp.

Nut for Carriage-Top Props. John Winter, Goshen, Ind. No. 952,856. Patented March 22, 1910.

A nut for carriage top props comprising a polygonal body having a threaded bore extending axially, one end face of body being concaved and formed with a comparatively thin tubular extension circumscribing the end of the bore and concentric therewith, the end face affording a concave shoulder of irregular

outline surrounding the extension, which is of greatest depth at the central points of the side faces, a concavo-convex disk having an axial opening receiving the tubular extension, which is riveted down to hold the disk tight upon the body, the convex side of the disk fitting snugly against the shoulder, a greater

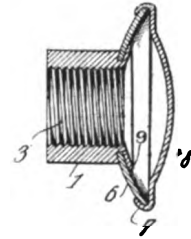

portion of the extension bearing against the disk opposite the side faces of the polygonal body than at points opposite the corners, the shoulders at the corners being of greater width than at the sides, the peripheral edge of the extension, when overturned, projecting beyond each face of the body and the corners of the body projecting beyond the peripheral edge of the overturned extension.

Motor Car. Frederick R. Martin and Oswald M. Shepherd, London, England. No. 952,457. Patented March 22, 1910.

A motor vehicle comprising the frame, a dead axle resiliently carried thereby, a live axle, comprising a central portion rotat-

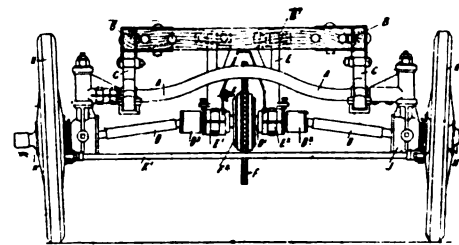

able supported by the frame independently of the dead axle, and side portions flexibly connected to the central portion by means of universal joint boxes, the support for the live axle being a forked bracket suspended from a cross bar of the frame, a motor having a balanced geared connection with live axle and means for effecting relatively independent vertical movement of engine and balance gear without altering the distance between the driving connections.

Wheelwright Machine. Augustus A. Merrill, Mallard, Iowa, No. 952,623. Patented March 22, 1910.

The combination of a frame, a tool carrying shaft mounted for sliding and rotary movement, a member swiveled to shaft, a

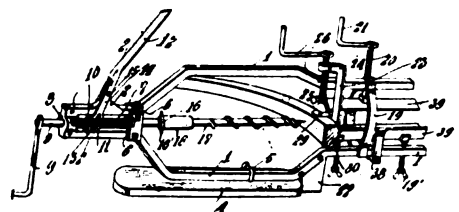

longitudinally bowed spring having one end connected to frame, and its other end detachably engaged with the swiveled member for actuating the shaft longitudinally, a catch upon the frame to engage the free end of spring, means for rotating shaft, and means for moving shaft longitudinally.

Convertible Automobile Body. Ransom E. Olds, Lansing, Mich., assignor to Reo Motor Car Company, Lansing, Mich. No. 952,575. Patented March 22, 1910.

The combination with a vehicle body having a permanent seat and an integral sill portion extending in rear, a supplementary body portion forming a closed permanent deck upon the sill portion and comprising an end, sides and a rearwardly sloping top, the deck formed with a hinged seat section comprising an intermediate portion of the top and portions of the sides adjacent to the ends of the intermediate portion and rigidly attached

thereto, and a supporting rail for the seat section upon the rear of the deck, the rail having spherical enlargements and the

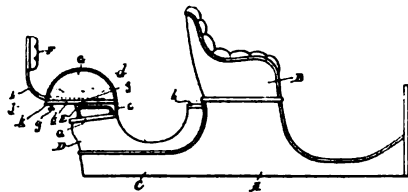

seat section provided with cup-shaped bearings adapted to register therewith when the seat is folded rearwardly.

Reach Connection for Vehicles. William S. Peter, Damar, Kansas. No. 952,380. Patented March 15, 1910.

A reach-coupling for vehicles comprising upper and lower plates carried by the hounds, horizontally swinging reach engaging jaws arranged between and pivoted thereto and extend-

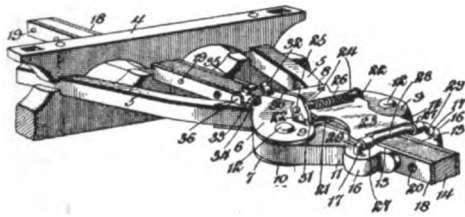

ing beyond the plates, the extended portions of the jaws having flat sides adapted to bear against the reach, pins projecting from the flat inner sides of the jaws and adapted to engage openings in the reach, and means for locking the jaws in their engaged position.

RECENTLY GRANTED PATENTS OF INTEREST TO THE VEHICLE INDUSTRY.

- 940,915—Vehicle Lamp. F. C. Ahrens, Chicago, Ill.
- 940,919—Cushion Tire. C. O. Baughman, assignor to W. J. Frank, Akron, Ohio.
- 941,058—Wheel Tire. F. L. Berg, Owatonna, Minn.
- 941,129—Motor Vehicle. J. A. Charter, Chicago, Ill.
- 941,063—Automatic Vehicle Brake. C. E. Crumm, Anutt, Mo.
- 940,859—Mud Scraper for Wheels, J. O. Davison, Murray, Ia.
- 941,015—Resilient Tire for Vehicles. G. O. Draper, Hopedale, Mass.
- 940,960—Tongue support. W. C. D. Evans, Whittier, Cal.
- 941,195—Camping Wagon. D. L. Hardin, Hoyt, Kansas.
- 941,326—Shaft-tug Attachment. A Littman and W. J. Lackie, Cleveland, Ohio.
- 940,982—Pole-attaching Means for Vehicles. J. G. Maloney, Scranton, Pa.
- 941,329—Spring Wheel. A. R. Miskin, Idaho Falls, Idaho.
- 940,721—Dumping Vehicle. W. H. Phillips, Fairmount, N. D.
- 941,274—Canopy Top for Vehicles. J. Reid, Childress, Texas.
- 941,170—Guard or Fender for Vehicle Wheels. J. O. Roberts, Granger, Texas.
- 940,904—Spring Tire. R. M. Spencer, Edwall, Wash.
- 941,289—Tire. A. T. Tizard, Durango, Colo.
- 940,771—Checking Attachment for Carriages and Wagons. W. F. Young, Chicago, Ill.
- 941,753—Wheel. F. E. Bertrand and G. Portsche, Lincoln, Neb.
- 941,550—Spring Wheel, C. W. Baeder, Memphis, Tenn.
- 941,976—Vehicle Wheel, H. O. Clark, New York, N. Y.
- 941,625—Tenon-forming Machine for Wheel-spokes. E. Davis and E. E. Davis, Sugargrove, Pa.
- 941,983—Vehicle Seat. F. J. Elsner, Racine, Wis.
- 941,508—Cushion Tire for Vehicles. E. E. Euchenhofer, Dayton, Ohio.
- 941,871—Pneumatic Tire.—C. M. Gautier, Putney, London, England.
- 941,514—Four-wheel Positive Drive. O. A. Goodrich, assignor of five-eighths to J. N. Warren and one-eighth to F. A. Seaman, Sioux City, Iowa.
- 941,677—Power Truck. J. B. Heverling, St. Louis, Mo.
- 941,453—Cushioned Wheel for Vehicles. W. J. Higman, Denver, Colo.
- 941,876—Vehicle Brake, W. T. Hinshaw, Valley Station, Ky.
- 941,711—Brace for Dashboards. F. H. Hosay, Gallatin, Tenn.
- 941,993—Anti-slipping Attachment for Motor Vehicles. M. Jensco, Butler, Pa.

- 942,000—Means for Propelling Vehicles. J. C. Leydorf, Perryburg, Ohio.
- 941,926—Spring Tire. W. L. Johns, Soquel, Cal.
- 941,683—Apparatus for Treating Wooden Wheels, J. J. Lipe, Witt, Ill.
- 941,939—Hitching and Steering Device. L. B. McAlpine, assignor to Climax Road Machine Co., Marathon, N. Y.
- 942,005—Wheel. J. W. Meyers, Freeport, Ill.
- 941,943—Thill Tug or Carrier. W. H. Noggle, Lancaster, Ohio.
- 941,956—Sideboard Attachment for Wagons. A. Sanders and C. M. Rebman, Okemah, Okla.
- 941,386—Vehicle Pole. C. B. Schleicher, Brady, Neb.
- 941,822—Means for Attaching Axle Boxes, E. J. Spahr, assignee of one-half to O. Semler and E. Bohrmann, New York, N. Y.
- 941,962—Pneumatic Tire Shoe Manufacturing Machine. W. C. State, assignor to F. A. Seiberling, Akron, Ohio.
- 941,970—Auto Propellor. E. E. Wilson, Scottsville, Kas.
- 942,161—Wheel Block. A. J. A. Bennett, Seattle, Wash.
- 942,431—Whiffletree Hook. R. F. Bloom, Starbuck, Minn.
- 942,364—Vehicle Wheel Tire. J. A. Boyajean, New York, N.Y.
- 942,612—Carriage Curtain Fastener, F. S. Carr, Brookline, assignor to Carr Fastener Company, Boston, Mass.
- 942,819—Wheel. C. C. Foss and C. L. White, Quitman, Ga.
- 942,319—Fore Carriage. J. W. Gamble, Carpentersville, Ill.
- 942,563—Truck. C. J. Ingard, San Francisco, Cal.
- 942,567—Automobile Tire. I. B. Kempshall, Boston, Mass.
- 942,082—Sleigh Attachment for Automobiles. P. M. Knutson, assignor of one-half to H. Kram, Clifford, N. D.
- 942,266—Transmission gearing. C. B. Kurtz, Lakewood, Ohio.
- 942,654—Tire. J. G. Maxwell, Washington, Pa.
- 942,182—Running Gear. A. T. Newell, Birmingham, Ala.
- 942,097—Tire. B. F. Norcross, Waltham, Mass.
- 942,406—Transmission gearing, L. C. Norton, Los Angeles, Cal.
- 942,842—Cushion Tire for Vehicle Wheels. J. H. Poole, assignor of three-eighths to F. L. Price and three-eighths to J. G. Wilde, Brockton, Mass.
- 942,741—Cushion Wheel. E. J. Pope, Holyoke, Mass.
- 942,793—Supplemental Seat. A. Reineke, Chicago, Ill.
- 942,219—Vehicle. A. F. Rockwell, assignor to New Departure Manufacturing Company, Bristol, Conn.
- 942,292—Shifting Rail for Vehicle Seats. A. E. Smith, South Bend, Ind.
- 942,471—Wheel Scraper. C. W. Stark, Mountain Lake, Minn.
- 942,418—Tire. W. R. Stewart and T. S. Stewart, Saltsburg, assignor of one-third to A. S. Braverman, Avonmore, Pa.
- 942,149—Tire. J. C. Taylor, New York, N. Y.
- 942,151—Automobile Axle. M. D. Tindal, Columbia, S. C.
- 942,225—Automobile Wind Shield. A. W. Toyle, assignor to P. Wendel, Chicago, Ill.
- 942,682—Tire Protector. F. Vacher, New York, N. Y.
- 943,623—Change-speed Gearing. L. W. Anderson and A. R. Murray, Cincinnati, Ohio.
- 943,371—Pneumatic Tire. A. F. Angelicola, New York, N. Y.
- 943,173—Vehicle Tire. T. H. Banks, San Antonio, Texas.
- 943,513—Sled Runner. D. L. Blocher, Bordulac, N. D.
- 942,882—Transmission Mechanism. E. Bonneau, Brest, France.
- 942,883—Hub Odometer. H. P. C. Browne, New York, N. Y.
- 943,341—Tire Supporter. S. T. Coate and J. T. Saris, Springfield, Ill.
- 943,396—Automobile Tire. W. G. Dicker, Gilby, N. D.
- 943,064—Cart, J. J. Devine, Philadelphia, Pa.
- 943,397—Spring Wheel. J. A. Dieterich, assignor of one-half to G. Blumenstock, Cleveland, Ohio.
- 943,240—Automobile Gear. H. P. Dodge and C. M. Foster, Toledo, Ohio.
- 942,896—Shock Absorber. J. H. Friedenwald, Baltimore, Md.
- 943,112—Vehicle Wheel. A. Graff, Wellington, Kas.
- 942,907—Gasoline Tank for Motor Vehicles. R. Huff, assignor by mesne assignments, to Packard Motor Car Company, Detroit, Mich.
- 943,025—Automobile Tire. I. B. Kempshall, Boston, Mass.
- 943,026—Tire Protector. C. E. King, Washington, D. C.
- 943,257—Section for Automobile Radiators. H. Kurtzner, New Haven, Conn.
- 943,640—Pneumatic Tire. A. Latimer, London, England.
- 943,029—Vehicle Wheel Rim. P. W. Litchfield, assignor to Goodyear Tire and Rubber Company, Akron, Ohio.
- 943,358—Tire. P. W. Litchfield, assignor to Goodyear Tire and Rubber Company, Akron, Ohio.
- 943,430—Vehicle Tire. T. W. Lucke, Chicago, Ill.
- 943,446—Wheel Tire. H. L. McDuffee, Gilroy, Cal.

Copies of above patents may be obtained for fifteen cents each, by addressing John A. Saul, solicitor of patents, Fendall Building, Washington, D. C.

SHOCK ABSORBERS.

Springs and tires are in themselves shock absorbers, though there is considerable variation in the degree in which they work as such. A laminated spring would probably act better than a coil spring doing similar work, owing to the action of the leaves, which have a creeping motion, each leaf being subject to a variable elongation as the axle rises; and if the length of the different leaves is correctly proportioned, the frictional resistance caused by this creeping of one leaf on another is a useful adjunct to the elasticity of the spring as a whole. This it is that accounts for the predominance of the laminated spring in locomotive and railway wagon practice. The main desideratum in a shock absorber is increased frictional resistance, either by the rubbing of one surface on another, or by fluid pressure or other similar means.

When a wheel meets an obstruction to its smooth passage on the road surface, the axle is forced from its ordinary position, and the springs, becoming distorted, exert a pressure on the shackles, tending to raise or lower the suspended portion of the chassis, according as to whether the obstruction met is above the road surface or below, as instanced in a rut. This action, says an English writer, is the cause of creating a series of vibrations, and it is the duty of the shock absorber to instantly start to check these, and so conduce to the comfort of the car occupants. A certain amount of discrimination must be manifest in the action of a good shock absorber, and it is expected to leave or practically leave alone the small irregularities of the road surface, which should expend themselves in the frictional resistance between the leaves of the spring, but at the same time to be on the alert for exceptional bumps, in the rebound of which its action must be immediate.

Not only must it have this damping effect on vibration, but it is intended to keep the wheels on the ground, and it was originally fitted to racing cars with this intention. Herein lies a point which is worthy of a little closer consideration, as it bears on the ever-present subject of tire wear.

It is patent to all motorists that the driving wheels of their cars are frequently off the road altogether for a fraction of a second, just after encountering an obstruction. Let us consider what happens during this very small, though ever recurring, interval of road contact. For the sake of argument and simplification, take an imaginary car without springs, running at about 20 miles per hour, which encounters a small stone about 1 inch high. Of course, this example will give an exaggerated result, but the obstruction and speed taken being only moderate, it may be safely assumed that similar results will occur in ordinary practice, wherein larger obstacles are often met, and the speed is sometimes greater. Those anxious to check a little problem in mathematics, or rather kinematics, will find that on the assumption that we are using a 30-inch driving wheel in our example, the said wheel after striking the obstruction will remain in the air for the larger part of a second, and as 20 miles per hour is approximately 30 feet per second, we find that a wheel may travel some few yards without actually coming into contact with the ground. Of course, as before stated, this is an exaggerated case, but it serves to draw attention to the fact.

This action has a direct bearing on tire wear, and as will be pointed out shortly, shock absorbers also play a not unimportant part in this phase of a car's suspension. Now then, in what way does this affect the tires? If we continue our argument in the vein of assumptions, suppose the wheel to remain in the air for only one-half of a second, and the engine to be revolving at 1,200 r.p.m. This is well within the bounds of reasonable data, and yet it is quite obvious that during that half of a second in which the wheel is off the surface of the road, the engine will perform 10 partially wasted revolutions, as it is running at 1,200 revolutions a minute, which, divided by the 120 half seconds contained in a minute, gives 10. Now what do these 10 revolutions do? They cannot directly drive the other wheel, assuming it to be on the ground, because of the differential gear, therefore

those special 10 revolutions must work through the balance gear and thus accelerate the linear speed of the wheel in the air, so that the tire comes into contact with the road again at a greater speed than that at which the car is traveling.

In our example, assuming a medium negative acceleration for the car, during the time of the wheel is off the road surface, the linear speed of the tire when it reaches the ground again would be nearly 1 foot per second in excess of the speed which it has to instantly assume as it once more takes up the drive. Now it does not need much consideration to see that this would be very detrimental to the tires, and also somewhat damaging to the road surface. These figures are, as already explained, an exaggerated case, as the wheel of a car fitted with springs and pneumatic tires would probably only be in the air in similar circumstances, for about 1-12th of a second, but even in that time the engine would do very nearly two revolutions. How, then, do shock absorbers affect this?

It is obvious when surmounting an obstacle, the frictional resistance of the shock absorber while the wheel is rising must of necessity add to the upward reaction of the framework to which it is attached. Bearing this point clearly in mind, we now consider the action coming down from the obstacle, in which moment the wheel is, or should be, increasing its distance from the chassis towards the ground. In this case, the upward reaction on the framework and the downward pressure of the spring on the axle are lessened by the amount of frictional resistance contained in the shock absorber.

Thus it would appear that there is reason to think that, in this respect, it really stiffens the spring when it is under compression, and weakens it on the return movement, which seems to indicate that, as a matter of fact, the wheel of a car fitted with shock absorbers would probably stay in the air longer than the wheel of a similar car without them, as the returning action of the main spring (assisting gravity to restore the wheel to the road), is lessened by the amount of frictional resistance stored in the shock absorber. If this is so, we should be drawn towards the conclusion that they did not increase the life of a tire, and begin to wonder whether or no they had a slight tendency in the opposite direction. This is a point well worthy of consideration, and while we should certainly hesitate to make the assertion that the facts are as suggested, nevertheless a careful perusal of the argument seems to point in the direction. Of course, in any case it does not affect the main object for which a shock absorber is provided, viz., the checking or damping of excessive vertical movements and the absorption of trans-vibratory oscillations, but it is not infrequently claimed that they increase the life of the tire, a point which, maybe, is open to discussion.

There is in some cases a tendency to make the damping effect produced equal both for the upward movement and also for the rebound. Now a little consideration will show that to do this must in reality have the effect of stiffening the main spring, whereas what is really wanted is chiefly to check the rebound. Opinions appear to be divided on this point, so it does not do to be didactic about it; but at the same time it is fairly obvious that the springs, if correctly designed, should be allowed free play to perform their part of the shock absorption, and if you stiffen them materially you must tend to limit their action beyond what was originally intended by the designer.

It would appear, then, that it is preferable to allow free, or nearly free, movement to the springs on the upward action, the actual checking to only take place on the rebound. As already stated, however, opinions differ very largely on this subject of shock absorbers.

Illustrations on Page 6 show different types, and a considerable variation is seen. Though these by no means exhaust the list they give a fairly good insight into the different ways and means adopted to obtain a similar result. They vary from a small compressional spring or a torsional rubber band to either a hydraulic, air, or other fluid compressor, while a not inconsiderable number employ various types of friction plates.

AUTOMOBILE SECTION

The Hub

SPECIALLY DEVOTED TO THE DESIGN, CONSTRUCTION AND FINISH OF THE MOTOR CAR

SOMETHING ABOUT FRAMES.

A fact not known to every motorist is that the familiar universal joint is a great absorber of power. Where two shafts, coupled by this method, are run perfectly true and horizontally, without whip, then the losses in transmission are neglected to all intents and purposes, but once either of the shafts is deflected ever so slightly, wastage of power occurs immediately. The greater the obliquity or angularity of the shaft, the greater the loss of power being conveyed. It is because of this disadvantage that in many of the most modern cars we see but a single joint behind the gearbox. Nevertheless, the continuously deflected propeller shaft still dissipates the power to a very considerable extent. In fine, "he who knows" does not like universal joints in automobile driving mechanism; hence the motor car engineer restricts himself in their use as much as possible, says a writer in Motor.

Whether it would be both efficacious and satisfactory to do away with joints altogether is a subject full of interest. That is to say, can we so construct the chassis that, notwithstanding road oscillations caused by defective road surface, all the shafts shall remain in true alignment. I am not unable to put forward a plan whereby this desideratum may be obtained. And I think it a method equally applicable to large as to small chassis. It should not be confused with other previous propositions, nor with a recent Continental innovation—a frameless motor car, wherein the engine and gearbox are connected rigidly to the trailing axle by a central tube of large diameter. In such a style of construction the twisting strains on the tube—and therefore, on the motor, gears and axle—would be very heavy; so that the advantage of having all the shafts in alignment is nullified by the weak resistance offered to the stresses set up by road oscillations. The plan I render is, I venture to say, neither complicated nor doubtful. To the contrary, in its simplicity, strength and sureness of answering the purpose lie the chief characteristics.

Turning, therefore, to Fig. 1, of the accompanying drawings, A is the engine, B the flywheel, C the change-of-speed gearbox, D the shaft brake, E the propeller shaft, and F the live axle. The motor, gearbox and longitudinal shaft are contained within what may be termed the central cantilever pattern or latticed girder frame (G), the fore part of which is attached at a single point by a trunnion (H) on a front cross member of the pressed steel frame (I). The after part of the cantilever frame (G) is fixed at two points on the tapered barrels of the live axle casing. Now the trunnion piece (H) may be so made as to allow the frame (G) and the live axle to oscillate as freely as usual, and the latter describe an arc of a circle, since the trunnion could be hinged, allowing the engine and gear-carrying frame (G) to rock slightly to and fro, both lengthwise and transversely. Or, for the same purpose, the frame (G), where it is attached rearwardly to the driving axle, may be slidable longitudinally thereon. Plainly, by the plan proposed, three-point suspension is obtained, not part of the transmission system, as is ordinarily the case, but of the whole.

It is to be observed that this feature is one of the highest importance. It seems that the engine crank axle and every shaft behind it remain together in constant alignment. So effectual

should this style of building be in practice that an efficiency at the driving axle of nearly 100 per cent ought to be obtainable easily, provided, of course, that the cantilever frame be an absolutely rigid structure in itself; the least weakness therein would defeat completely the object of the system. If the locomotive is compared with the motor vehicle, it becomes tolerably clear that the car of the road is, after all, extremely deficient (practically and theoretically) as to mode employed of conveying power to the driving axle.

In the locomotive you may say that a rigid rod transmits the power direct from piston to axle, and the closest approximation we yet possess to this point of superiority is to be found in the original Decauville or DeDion-Bouton type of voiturette, wherein the motor shaft drives the axle directly through a small spur pinion meshing with a large one. If we go further, and consider for a moment the propeller shaft of a steamship, we find that it is kept as straight and rigid as possible by several bearings, and certainly no shipbuilder would willingly employ knuckle joints. I wish to make it plain, therefore that the greatest pains

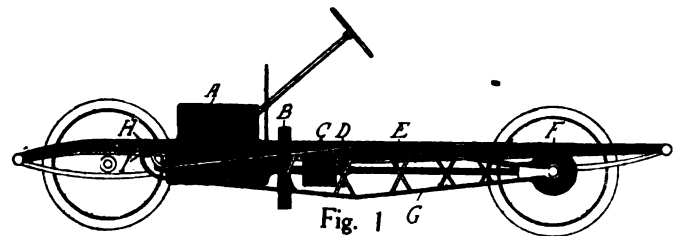

should be taken to maintain the revolving shafts of the motor car—four, and sometimes five, in number—so rigid that all might safely be looked upon as turning in a single plane.

I contend that the finest pressed steel automobile frame yet made will not be capable of resisting without deflection the shocks to which it is subjected. Its necessarily oblong, flat shape is quite out of harmony with the requisite strength. In a word, the outrageous road surfaces—sharp curving to boot—with which the motor car user meets at almost every turn, entail twists and stresses on the frame of a motor vehicle that nothing short of a radical change in shape and system of construction could oppose successfully.

There is another matter of interest to which I shall now draw the reader's attention. We most of us are aware that the shafts in the modern speed-changing gearbox are very short. The shafts are well supported in double end ball bearings. "I give you short and stiff shafts in this gearbox—no whip here," says the motor car builder. But the curious fact is that behind that case of gears a lengthy propeller shaft extends to the driving axle. Nowadays, at its forward end, it comprises a universal joint; at its bevel wheel end it is rigid with the balance gearbox. Hence that shaft is "springing" all the time it turns, thereby wasting power by straining at joints and bearings.

To many minds may occur the remedy of using a shaft of larger diameter. But this expedient is out of the question, for it would necessitate an extremely thick and heavy shaft to arrest the play. The evil may be vanquished very simply by placing within the tubular casing of the propeller shaft one or more bearings at suitable distances apart, which bearings would be arranged to surround the shaft. Thus, instead of increasing the

shaft diameter, we may actually reduce it, yet keep it like a rigid rod, suffering no distortion. I do not show this feature in the drawings, nevertheless I would propose that the shaft (E) be supported by struts across the frame (G), carrying at least two bearings for that shaft.

The effect of adopting the girder-like lattice frame, attached in the manner and at the points I have mentioned, is much like that of placing on the car a miniature bridge of the strongest form. Carrying its driving and driven shafts dead true, it will rise and fall with the motion of travel, but warping of the structure need not be feared. Let any doubter of its strength show the design to an experienced constructional steel worker. Admittedly, it is not unnatural that many will regard the system with disfavor on the ground that it adds weight to the car. However, on this head also it would be well to pause before condemning the principle I have set forth. In the drawings the frame (G) is shown containing the conventional enclosed crankcase and gearcase. To-day, the unit system is favored to a great extent, yet a number of its devotees are not much pleased on the score of its accessibility.

I suggest, therefore, that, on the plan described, it is possible to achieve the advantage of extensive ease of approach by the straightforward expedient of shrouding the cantilever frame

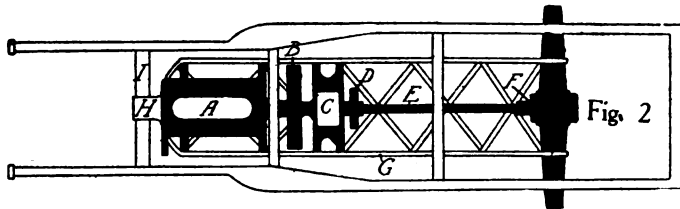

with thin sheet steel. Weight would be reduced; there would then be no necessity for comparatively heavy castings for crank chambers, gearboxes and so forth. Either light, oil-containing, closed pans could be fastened close to the axles and shafts, or, on the other hand, the mechanism-carrying frame could be altogether of smaller dimensions than illustrated.

I do not pretend, even by means of the weight-paring written of, that a car of this kind would be lighter than usual; without doubt, it might well prove heavier, and no amount of skill might lessen the dead weight. But here an interconnected topic is entered upon. The light car of conventional design unquestionably loses power and wears out tires through lack of proper adhesion between wheels and road. This peculiarity is caused by the relatively light load on the driving axle. The weight of the engine and gears is in front, and the weight of the occupants does not counteract against it nearly so much as might be supposed. With the system now under discussion, the weight is borne by the rear axle in a wholesome fashion that should tend to keep the rear wheels more snugly upon the road surface.

The plan affords other advantages. In the shops, the construction would comprise complete instead of partial unit building. For repair, likewise, the driving mechanism in its entirety is capable of being removed from the car with the driving axle in place. Disconnection of the trailing axle from the springs and the trunnion from the crossbar would enable the workman to run upon a trolley to any convenient part of the shops what is the main part of the machine.

It is almost superfluous to point out that torque and radius rods are dispensed with. Of course, the arrangement of minor details calls for the exercise of some ingenuity. For example, a suitable system of flexible pipes would have to be devised for the radiator, fuel and oil tanks, or else the latter might have to be supported by the oscillating frame (G). Then, again, a special form of sliding joints for the connections of the gear-operating and like levers would be demanded.

J. E. Demar Co., manufacturers of automobile bodies and tops, have leased the six-story and basement garage at 304-306 West Forty-ninth Street, New York City, for a term of years at an aggregate rental of about \$100,000.

OSCILLATING VALVE.

The Automobile describes and illustrates a new engine valve of oscillating type that should interest those who have to consider the practical improvements of the gas engine. The article gives all the necessary information, including the name of the inventor:

Valves have aroused much interest in the past year or so, primarily through the wonderful success of the Knight engine with the sliding sleeve valves. Many inventors have brought out other forms of valves, possessing points of apparent super-

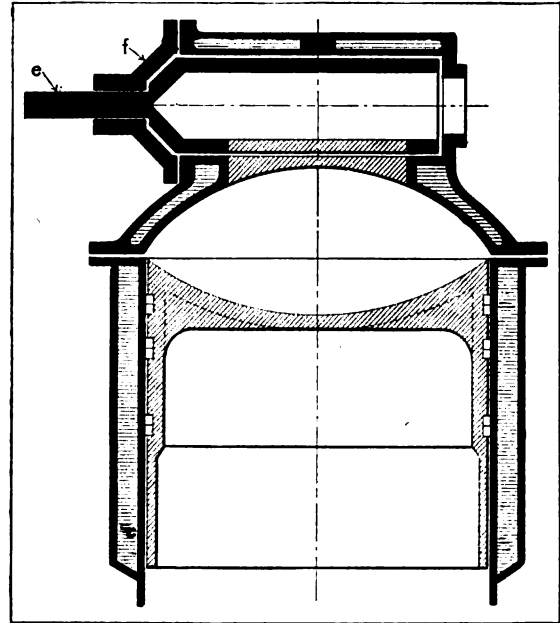

Fig. 1—Section through cylinder showing valve in place

iority over either the sleeve form or the old style poppet valve, or both. One of the newest inventions in this line is that pictured on this page in several cuts, and the invention of M. S. Keyes, an automobile engineer.

As Figs. 1 and 2 on this page show, this invention consists of a tubular sleeve used for a valve. This sleeve has cut into its one side a number of ports, which are presented to the open combustion chamber in succession. To operate the valves—for there are but one per cylinder—the regular camshaft is used, but instead of a sliding or lifting motion, as in the case of the poppet valve, or a rotary motion as in some valves, the motion

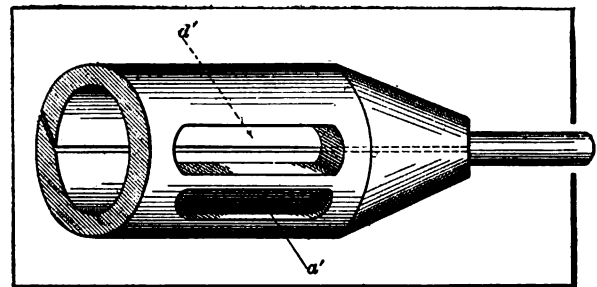

Fig. 2—Sketch of valve showing ports cut in the side

given to these sleeves is that of a partial rotation followed by similar partial rotation in the opposite direction, in short, oscillation.

As Fig. 3 shows, this is accomplished from the usual camshaft by means of an L-shaped lever placed on the side of the head—for these valves are located in the head—and operated by the upper end of the push rod, this motion being restrained, and the downward motion produced by means of a strong spring, which works against the other end of the L-shaped arm, and at right angles to the direction of the push rod.

Inflow of gases and outflow of the exhaust are through the interior of the tubular form, the inlet and exhaust pipes being

bolted up to the cylinder heads on the side opposite to the operation. This gives a certain amount of end thrust on the valve, both from the inflowing carburated air and the reaction from the fast-flowing exhaust. This is cared for, as is also wear, by means of a taper end.

To take care of unequal expansion and contraction, the side of the sleeve opposite to the ports is slotted with a fine slot, which allows the valve to adjust itself to the temperature of the

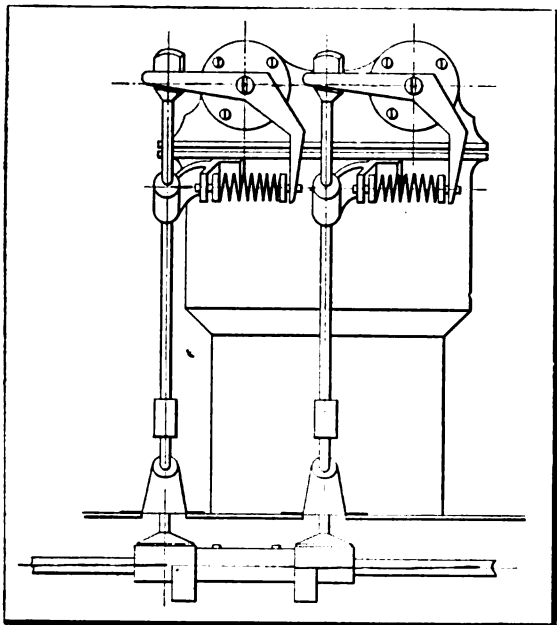

Fig. 3—Assembly of engine fitted with valve mechanism

surrounding chamber. This slit is made large in the drawing to bring out the point. Similarly, the opening in Fig. 1, connecting the port in the valve with the combustion chamber, is sectioned by mistake. This should show an opening, as the valve is set in the open position.

One advantage which this design has is that of calling for water jackets all around the valve, not alone below, as is common, but also above and on all sides, so as to completely surround the valve. This circular form makes this easy, without destroying the symmetrical appearance of the cylinder head. The latter is in a separate piece and bolted in position, so that removing it for an inspection of the valves, should one desire to do this, is an easy matter. To carry out the idea of a perfect combustion chamber, at least as to shape, the piston is hollowed down to a spherical shape, the part of the chamber which is in the head being similarly shaped. This form, according to scientists, gives the most nearly perfect results.

CARBURETOR-LESS ENGINES.

A concern in Chicago is making a two-cycle engine operated without carburetor. A few of the details are herewith given: Pure air is taken into the crank case instead of the usual gaseous mixture. It is compressed on the down stroke to about 4 pounds per square inch, and instead of by-passing into the firing chamber it is taken through a cast jacket to what is called the main valve. The crank case pressure also is utilized to force fuel from a tank to the main valve. By an ingenious arrangement the piston in its downward stroke creates a vacuum in a chamber which contains a small piston fastened to the lower end of the main valve. This vacuum causes the valve to rise which admits a scavenging charge, pure air from the crank case forcing out the residue of burned gas through the exhaust ports. As soon as enough gas has passed through the main valve to reduce the pressure to a certain point the fuel is admitted when the main valve closes automatically. The operation of the main valve is dependent upon the speed of the piston and being entirely automatic, the makers state that the supply of air and fuel is very accurately controlled under all conditions of speed and load.

DOUBLE AUTO SHOW.

A novel departure will be inaugurated next year by the automobile industry when, for the first time in America, the automobile trade will have a two weeks' show. Owing to the many additions to the ranks of the Selden patent licensees the Association of Licensed Automobile Manufacturers has planned a double show to be held in Madison Squire Garden in 1911. The dates selected are January 7 to 14 for pleasure vehicles, reopening Tuesday, January 17 and closing January 24 for commercial vehicles.

In order to properly care for the exhibitors arrangements have been made for the Show Committee of the A. L. A. M. to rebuild the interior of the Garden, thereby obtaining 20,000 square feet more floor space than has been available at previous shows. This additional space will be acquired by extending the elevated platform so that it will be fifty feet wide, with another platform overhead extending from the level of the balcony. When this is accomplished and the commercial vehicles are cared for at the end of the second week the Show Committee will be able to accommodate eighty exhibitors of vehicles in spaces of the same size as those used in the last show. This new construction will give sufficient room for all the present Selden patent licensees. There will be accommodations for twenty-seven exhibitors of motor cycles and about 300 motor and accessory manufacturers.

The plan of a double show that will give proper space to the pleasure vehicle maker and care for the fast increasing number of commercial car manufacturers has been the subject of long discussion among those interested, and while the expense and work involved will exceed that of any previous exhibition, the affair will be representative of the industry.

Work will begin early in the Fall on the preparation of the interior construction, which will be made in sections to permit rapid installation. When the pleasure vehicle show closes on Saturday night the exhibits will be removed and their places taken by commercial cars. The signs and carpets will also be changed, but the main decorations will be carried through both exhibitions.

FRENCH AUTOMOBILE BODY DESIGN.

(Illustrated on page 6.)

The body shown is small and of graceful line. It is for inside driving. The chassis is a Renault. It has features worth attention because of compactness, style and methods of construction, something away from the ordinary.

The door is provided with stationary light, upper section being hinged, and made to lower on the inside, glass being divided with a joint in center of frame on top and sides. The upper side, back quarters, and roof are covered with enamel leather, with bows, strainers, etc., on inside being exposed and finished in natural color.

MOTOR GROCERY DELIVERY WAGON.

(Illustrated on page 5.)

The George Irving Company, of New York, supply in this example a class of work with which they have been very successful, owing to the skillful construction and designing, due to the cleverness of Mr. George Hopkins, of the company.

The body has a 12 foot length inside, a width of 5 ft. 2 in., and a height of 6 ft. 3 in. It is mounted on a three-ton chassis of the Packard make, and many wagons of similar workmanship and mounting have been put out by the Irving Company, with satisfactory results to users.

INDEPENDENT MOTOR CAR SHOW.

The Ruby Carriage Co. and others who did not want to participate in the big motor show at Louisville, held little shows of their own that proved to be magnets to all interested in the subject of motor cars.

AIR SPRINGS TO EASE ROAD SHOCKS.

Considerable attention was attracted to a system of pneumatic suspension which was applied to an automobile exhibited at the Olympic show in London. Its inventor, Archiband Sharp, has prepared an exhaustive thesis on the subject of pneumatic suspensions in general, which was presented before the Incorporated Institution of Automobile Engineers.

"If a springless vehicle moves over an uneven road," says Mr. Sharp, "the whole of the mass of the vehicle is subjected to a series of irregular accelerations in a vertical direction. The force required to produce the vertical acceleration is proportioned to the mass partaking of the vertical acceleration and to the vertical acceleration at the instant. The object of introducing springs

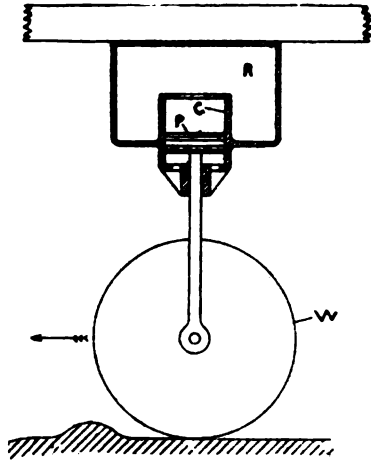

Fig. 1

in a road vehicle is to reduce the mass of that proportion of the vehicle which partakes of the vertical acceleration due to the irregularities in the road surface. The pneumatic tire, in running over a small obstacle on an otherwise smooth road, is ideal in this respect, since the mass partaking of the vertical acceleration is merely that of the small portion of the tire in the neighborhood of the obstacle. In a less degree, this applies to the solid rubber tire. But the pneumatic tire is of little value as a spring when the road surface is fairly smooth, but wavy or lumpy.

"Generally speaking * * * the less the mass of the wheel, axle and parts partaking of the vertical movement of the axle, the more advantageously applied is the springing. This at once suggests the much debated question of live axle versus chain drive; but we engineers learn by every day experience that in designing such a complex article as a motor car the engineer who places undue importance on any one element is not likely to produce the most desirable result. It is far from my mind to express the opinion that the live axle is inferior to the chain drive, on account of the non-spring-supported mass, well knowing that the springing of the vehicle is only one of the many factors to be considered by the designer."

The vertical acceleration of the unsprung vehicle is a question of pure kinematics, he explains and readily calculable if the precise conditions of vehicle speed and road surface are known. Ordinarily, it is needless to add, they are not known save in a rough and hazy way. Nevertheless, his calculations from assumed data are most instructive.

"Let us assume that a rigid wheel 30 inches in diameter is running on a level road," he says, "and suddenly encounters an obstacle 1 inch high. Let the speed of the vehicle be 22½ miles per hour—that is, 33 feet per second. * * * As it first touches the obstacle, the point of contact of the wheel with the horizontal surface of the ground is then 5½ inches, or say, half a foot, behind the obstacle. The center of the wheel moves forward the distance of half a foot in 1-66th part of a second, and in the same time the wheel is lifted vertically 1 inch."

It is assumed that the acceleration is constant during this time, the acceleration can be calculated by means of well known formulas in elementary mechanics, and is worked out by the

author at 726 feet per second—that is, 22 times the acceleration due to gravity alone. The force required to produce this acceleration—that is, the additional upward reaction on the wheel, over and above its own dead weight—is 22 times its weight.

"The center of the wheel being vertically over the obstacle," he continues, "it is still moving vertically upwards with a velocity. The average vertical velocity during the upward acceleration is 66 inches per second, and the final velocity at the end of the acceleration—that is, when the center of the wheel is vertically over the obstacle—is twice this amount—that is, 11 feet per second. The wheel will continue rising, and it will rise in the air a further distance of 2 feet, and will remain in the air nearly two-thirds of a second before reaching the horizontal road surface.

"If the linear speed of the vehicle be doubled, the vertical acceleration is four times as great; if the linear speed of the vehicle be trebled, giving a race track speed of 67½ miles per hour, the vertical acceleration is nine times as great—that is, 198 times that due to gravity—while the wheel will remain in the air nearly 2 seconds.

"The possibility of the wheel remaining in the air for even a fraction of a second without driving contact with the road, is of great importance as bearing on the durability of the tires. With the engine running at 1,200 revolutions per minute, if a driving wheel leaves contact with the ground for even a quarter of a second, in this period the engine makes 5 revolutions, and the energy of the explosions is expended in accelerating the driving mechanism, including the driving wheel. Therefore, when the tire reaches the ground its linear speed is faster than that due to the speed of the car, and it scrapes on the ground, wearing the tire, and possibly damaging the road surface.

"In a motor car the road wheel is pressed downwards by the spring, and is not in air so long as in the simple case above discussed. In a car in which the back axle load is 1,200 pounds, and the weight of the back wheels axle and all masses moving

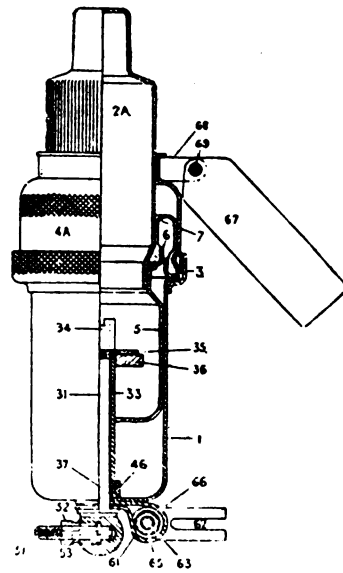

Fig. 2

with the axle is, say, 200 pounds, the downward acceleration of the wheel, which begins at the instant the center of the wheel is vertically over the obstacle, is six times that due to gravity—that is, equal to 192 feet per second.

"If the car is traveling at 22½ miles per hour, and the wheel encounters an obstacle * * * the wheel will remain in the air about 1-15th part of a second. If with the same conditions the speed of the car is doubled, the time the wheel hangs in the air is approximately doubled. If the weight of the non-spring-supported mass be smaller relative to the total wheel load, the time the wheel hangs in the air is reduced * * * .

"Fig. 1 is intended to illustrate in purely diagrammatic form the principles involved in the application of an air spring to a road vehicle. The axle of the road wheel W is attached by a

rod or the equivalent to a piston P, which is free to move up and down in the cylinder C. The upper end of the cylinder C is in communication with a reservoir fixed to the chassis, into which air can be pumped. The under side of the piston is exposed to atmospheric pressure. The vertical travel of the piston in the cylinder is, of course, limited. If a load be placed on the chassis while the pressure of the air in the reservoir is that of the atmosphere, the chassis is in its lowest position relative to the road surface, the piston presses on the upper end of the cyl-

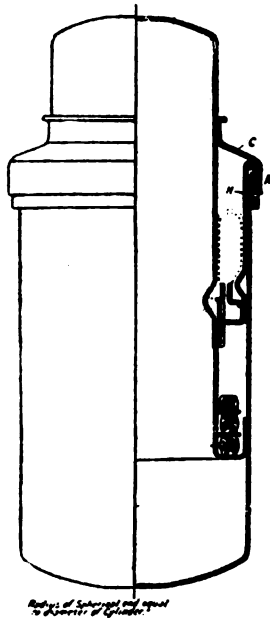

Fig. 3

inder, and the load is transmitted through the solid connections. The vehicle is then practically springless. But if air be pumped into the reservoir until the air pressure on the piston is just equal to the load on the chassis there will be no pressure between the piston and the top end of the cylinder. On pumping more air into the reservoir the chassis will rise and will be air supported.

"For example, if the total wheel load is 1,000 pounds, and the area of the piston 10 square inches, a pressure of 100 pounds per square inch will be required for the air in the reservoir. If this pressure is exceeded the piston will be blown into contact with the lower end of the cylinder, when the pressure in the reservoir is less the piston will be in contact with the top end of the cylinder. With the piston floating about midway in the cylinder, if the road wheel has to mount an obstacle, the piston is forced upwards in the cylinder, the total volume of air under pressure is slightly reduced, and the pressure per square inch is slightly increased. By making the volume of air enclosed in the reservoir large compared with the volume swept through by the piston in rising a given distance, the excess force producing vertical acceleration of the chassis can be reduced to a minimum.

"Thus, if the stroke of the piston in the cylinder be 4 inches, and the air is pumped so that normally the piston is in the middle of its stroke in the cylinder, the road wheel will be able to surmount an obstacle of slightly less than 2 inches in height, or will be able to drop into a hole in the road slightly less than 2 inches in height, without appreciably affecting the supporting force on the chassis.

"In practice I find it best to have the air pressure in the reservoir slightly in excess of that above described, so that normally the piston is pressing slightly against the bottom of the air cylinder. Under these conditions the full stroke of the air spring is available for the road wheel mounting obstacles, and there is no relative movement of piston and cylinder when the road surface is absolutely smooth. But when the road wheel dips into a hollow, the whole vehicle drops, and when the road wheel is rising out of the hollow, the piston rises in the air cylinder, and the chassis is then gently lifted by the excess air pressure.

"Any combination of a cylinder, piston and piston rod may be used for an air spring; the ordinary tire pump is a good example of such an air spring. But with the usual types of pistons and plungers that are met with in engines and pumps, no matter how perfect the piston-pump or packing may be, there is a slight leakage. The obvious solution is to have an air-pump driven by the engine which continually pumps air to replenish that lost by the leakage from the compressed air reservoir. The replenishment may be controlled by a valve under the control of the driver, or automatically. * * * In the system of air springs which I have invented, I employ a rolling packing 'mitten,' which permits of the piston or plunger being an easy, practical fit in the cylinder, and at the same time provides an absolutely air-tight joint."

The accompanying illustration, Fig. 2, shows the principle as applied in the cycle type of air-spring invented by Mr. Sharp, the construction of which is apparent even without reference to the guide numerals. Its parts are made of stampings from sheet steel. The principal members are upper and lower sections, which are made in two parts, suitably screwed together to form air-tight joints for the attachment of the mitten. The lower part of the air cylinder 1 is closed at the lower end, while its upper end is provided with a flange for the reception and fastening of the larger end of the mitten. The lower part, 5, of the plunger, is an easy riding fit in the lower part of the cylinder. The upper part 2A of the plunger is closed to form an external pin to which the saddle pin can be clamped. The smaller end of the mitten is pressed between a conical surface on the upper part of the plunger and a retaining ring 6 when the two parts of the plunger are screwed together. Similarly the larger end of the mitten is pressed between an inside conical surface on the cap 4A and the end of the air cylinder, when the screw ring 3 is turned up tight on the cap. The plunger is guided mechanically by the neck of the cap 4A and by the air cylinder.

When air is forced into the saddle pillar through the cap, and valve 51, in the base—to which an ordinary tire pump may be

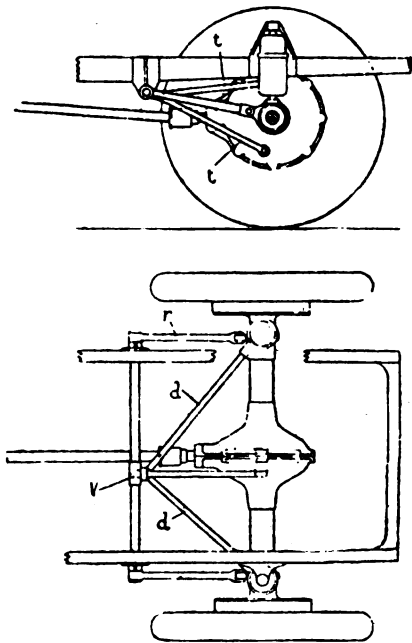

Fig. 4

attached—the plunger is forced upwards until the inturned flange on the lower part 5 comes into contact with the rubber washer 36. The device is assembled in an ordinary bicycle frame by means of the clamps 68 and 66. A device which is applied in the suspension of the front fork is similar in general construction. Regarding the construction of the all essential "mitten," the author continues:

"The rolling packing mitten is built up of two layers of parallel threads arranged close together side by side, the layers crossing each other at a small angle, 10 to 15 degrees, with the axis of the mitten; thus a thread of one layer crosses the

threads of the other layer at an angle of 20 to 30 degrees. A layer of india rubber is vulcanized to the fabric in the inside surface of the mitten, and this layer of rubber is relied upon for making the mitten impervious to air. Another layer of rubber is vulcanized on the outside of the mitten with the object of preserving the fabric as it rolls from the plunger to the cylinder, or vice versa."

For experimental purposes four of these devices were employed in the suspension of a light runabout. While their operation is said to have been satisfactory, the result showed that the wear of the mittens was excessive and that a large and modified construction must be necessary for work of this class. Accordingly the modified design shown in Fig. 3 was adopted. Mr. Sharp explains that it differs from the cycle type of air spring, "in that the central retaining bolt is dispensed with, and the large end of the mitten is held in a tubular holder H, the end of which is adapted to squeeze a rubber ring R against the end of the cylinder, making an air-tight joint therewith, when the screw cap C is screwed up.

"The end of the mitten holder forms a stop, limiting the outward stroke of the plunger. With this design, upon unscrewing the cap C the plunger, mitten and mitten-holder can be withdrawn from the cylinder and the mitten is then easily accessible. Joint pieces are fastened to the ends of the cylinder and plunger, respectively, to connect the air spring to the chassis, road wheel axle, or axle casing, respectively, the valve being inserted in one of the joint pieces. The diameter of the air cylinder is 3½ inches; the diameter of the plunger, 2½ inches, stroke, 3 inches; supporting area for calculation, 7 square inches; the volume of air enclosed when the plunger is fully extended is 87 cubic inches; the volume of air displaced by a full stroke of plunger, 21 inches. The parts are 0.5 inches thick, and the air spring can resist a proof test to an air pressure of 500 pounds per square inch.

"The air spring being adapted to resist merely an axial load, when used in a motor car lateral constraint must be provided between the wheel axle of the chassis, in addition to the longitudinal constraint. This involves a redesign of certain parts of the chassis. Fig. 4 shows one suitable sketch design of a live axle. It is to be remembered that air springs cannot resist the torque, so that torque rods are absolutely necessary. The live axle casing, torque rods and the two diagonal rods form a rigid pyramidal structure having its vertex at V. The vertex V is secured to the chassis by a universal joint. The two side radius rods ensure that the live axle will always remain approximately at right angles to the longitudinal axis of the car. The diagonals d in combination with the radius rods r ensure that the road wheels cannot move laterally relative to the chassis, while the two road wheels are free to move vertically, either separately or simultaneously, under the control of the air spring. The design of the front axle can be provided with equal facility."

THREE MORE SELDEN PATENT LICENSES.

Seventy-five makes of American and foreign cars now appear on the official list of Selden Patent Licensees. Those appearing on the list for the first time are: Flandrau Motor Car Co., of New York City, licensed to import and sell in this country the Brasier car; W. H. McIntyre Co., of Auburn, Ind., making the McIntyre car, and Simplex Motor Car Co., of Mishawaka, Ind., making the Amplex car, formerly known as the American Simplex.

A TRAFFIC DEPARTMENT ORGANIZED.

A Traffic Department has been organized by the National Association of Automobile Manufacturers, and the Executive Committee has notified motor car dealers that they may obtain information regarding freight rates and the collection of claims against railroads for over-charge, loss, damage, etc., without charge. The headquarters of the association are at 7 East Forty-second street, New York City.

PROMINENT MOTOR CAR COMPANY DISCONTINUES DEPOSITS IN ADVANCE.

Vehicle dealers who have looked askance at the practice prevalent in the motor car trade of paying advance deposits on cars months before date of delivery will be interested to know that the Mitchell-Lewis Motor Company have entirely discontinued this practice and no longer accept advance deposits. The company sends cars to dealers with sight drafts against bill of lading, so that the transaction is a matter of cash when the car is delivered.

The Mitchell company are the first car manufacturers to establish this as a settled policy and publicly announce it; although a few manufacturers, it is said, either privately disregard the rule or are lenient in enforcing it, accepting notes and note renewals not only up to date of delivery, but even beyond.

SMALL CARS GAIN GROUND IN GERMANY.

Statistics just issued by the German government in reference to the total quantity of motor vehicles in the Empire, place the number of automobiles at 24,639, divided as follows:

| | | Increase since January 1, 1909 |
|----------------------------|--------|-----------------------------------|
| Less than 8 h.p. | 12,595 | 33.5% |
| From 8 to 16 h.p. | 7,341 | 34.9% |
| From 17 to 40 h.p. | 4,605 | 28.1% |
| Over 40 h.p. | 98 | 27.3% |
| | 24,639 | 30.9% |
| Motorcycles | 22,283 | 6.5% |
| Total motor vehicles | 46,922 | 19.7% |

EFFICIENCY OF MACHINERY.

The thermal efficiency of gas engines ranges from 20 to 37 per cent; their mechanical efficiency from 65 to 88 per cent.

Centrifugal pumps run from 25 to 75 per cent. Fans average 50 per cent.

Shafting losses (estimated) 2 per cent per 100 feet, and belting and gearing runs from 5 to 50 per cent.

Wants

Help and situation wanted advertisements, one cent a word; all other advertisements in this department, 5 cents a word. Initials and figures count as words. Minimum price, 30 cents for each advertisement.

SITUATIONS WANTED.

Wanted—By foreman painter; ten years experience, capable, sober and dependable. All references. Address W. A., care The Hub, 24 Murray St., New York.

Wanted—By high class carriage or auto body finisher on new work. Best references. Address W. W., care The Hub, 24 Murray St., New York.

FOR SALE.

For Sale—We are closing out the entire lot of stock of the Troy Buggy Works Co., consisting of buggy and surrey bodies springs, axles, wheels, etc., at low prices on account of discontinuing vehicle business. Schedule on application. Must be sold at once. Write the Troy Manufacturing Co., Troy, O. io.

HELP WANTED.

Wanted—Bodymaker-draftsman on wood and metal automobile bodies. State age, education, experience and salary expected, and furnish references. Address ACE, 15, care The Hub, 24 Murray St., New York.

Body Makers Wanted—Experienced on highest class limousine and touring bodies; steady work; good wages; pleasant location. Address C. R. K., care The Hub, 24 Murray St., New York.

PATENTS.

Patents—H. W. T. Jenner, patent attorney and mechanical expert, 608 F St., Washington, D. C. Established 1883. I make an investigation and report if a patent can be secured and the exact cost. Send for full information. Trade-marks registered.

Is Horseflesh Cheaper than Gasoline?

Motor vehicle manufacturers recognized early in the game that the greatest obstacle they had to overcome to make successful cars was friction.

They realized it was folly to have a high powered efficient engine developing power under the hood that would be used up overcoming friction in other parts of the machine, so they got busy in the right direction and replaced the old fashioned friction bearings wherever they could with

TIMKEN ROLLER BEARINGS

until to-day—say NINETY ODD (90) per cent of all the makers of high grade American Automobiles are using **TIMKEN ROLLER BEARINGS**

in part or throughout in their cars—

And yet, strange to say, some vehicle manufacturers are still building and trying to sell vehicles that are not equipped with

TIMKEN ROLLER BEARINGS

Are you one of those that believes horseflesh is cheaper than gasoline?

IF YOU DO, WRITE US FOR "FACTS."

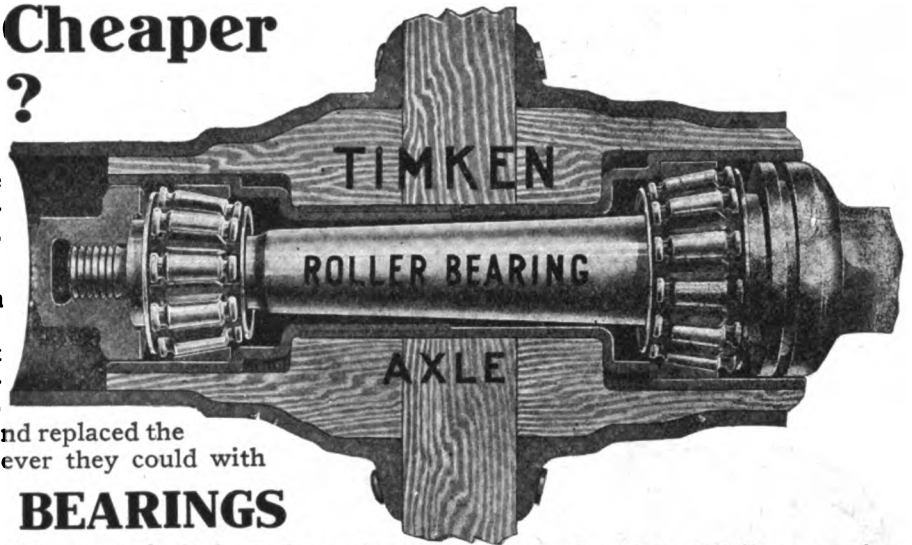

Branches
10 E. 31st Street, New York
429 Wabash Ave., Chicago, Ill.

THE TIMKEN ROLLER BEARING CO. Canton, Ohio.

MERITAS
STANDARD
OTC
COMPANY
OIL CLOTH

Cover a carriage top with MERITAS enameled oil cloth—cover another with any other kind—follow them up and see how long the tops last.

MERITAS will be in good condition long after the other has been caked, cracked and weather-killed.

Try it—then stick to the kind that lasts the longest.

Look on the back of the goods for our trademark.

See Your Jobber.

Standard Oil Cloth Co.
320 Broadway, New York

Painters and Decorators Save Time, Labor and Money, using the

Uebelmesser Stripping and Stencil Wheel

With this simple, clean and rapid-action tool the most ordinary decorator can do the finest stripping and stencil work and produce a bigger day's work with less labor than by the old fashioned method. Complete directions are furnished with each tool. They are as simple as the tool itself.

Just a few of the many designs that can be produced with the Uebelmesser Painters' and Decorators' Tool. (The designs shown above are reduced in size)

Complete Outfit consisting of Machine, 10 Plain and 10 Ornamental Wheels, only . . . **\$5.50**

LIBERAL DISCOUNT TO THE TRADE

Manufactured by
Charles R. Uebelmesser Company
Bayside, New York, N. Y.

Please mention "The Hub" when you write.



TRADE MARK

A New
Tire Drill

Most rapid working tool on the market for this class of work.

Capacity:
Any wheel up to 60 in. diam.
Any width of tire up to 6 in. wide.
Any hub up to 10 in. diam.

Better get some details of this Drill.

Send for Catalogue.

Established 1872.
W. F. & JNO. BARNES CO.
588 Ruby Street
ROCKFORD, ILL.

H.K. PORTER
27 YEARS **BOLT CLIPPERS** **27 YEARS**
EVERETT, MASS., U.S.A.

TRUCK BUILDERS

If you only realized the inestimable value of roller bearing fifth wheels on trucks, vans, delivery wagons and all other medium and heavy vehicles, no job would leave your shop without

Roller Bearing Fifth Wheels

WHY? The adjustment is perfect. No oil or grease required. Almost indestructible. Will outwear any vehicle. Saves horseflesh and prolongs life of vehicle. Ask your jobber for the celebrated

NIELSON OR KING

Let us send you Catalogue and Price List.
American Roller Bearing Fifth Wheel Co.
745 THIRD AVE., BROOKLYN, N. Y.

INDEX TO ADVERTISEMENTS.

| | |
|-----------------------------------------------|-----------|
| A. L. A. M. | 1 |
| American Ball Bearing Co., The | 2d cover |
| American Roller Bearing Fifth Wheel Co..... | 10 |
| Barnes & Co., W. F. & John..... | 10 |
| Bradley & Son, C. C. | 4th cover |
| Carter Co., George R. | 15 |
| Columbus Bolt Works..... | 4th cover |
| Consolidated Rubber Tire Co..... | 6 |
| Crane & MacMahon..... | 2d cover |
| Devoc, F. W., & Reynolds Co., C. T..... | 3d cover |
| Eberly & Orris Mfg. Co..... | 3d cover |
| Eccles Co., Richard | 15 |
| English & Mersick Co., The | 2 |
| Fitch Gear Co. | 12 |
| Gifford & Son, John A. | 15 |
| Goodrich Co., B. F., The..... | 5 |
| Goodyear Tire and Rubber Co. | 3rd cover |
| Hankinson, J. V. | 15 |
| Hoopes Bro. & Darlington, Inc..... | 2d cover |
| Indianapolis Dash Co. | 15 |
| Jones & Co., Phineas..... | 11 |
| Keystone Forging Co..... | 11 |
| LeCompte Mfg. Co. | 13 |
| Lounsberry & Sons, G. H. | 3rd cover |
| Masury & Son, John W..... | 2 |
| McKinnon Dash Co. | 4th cover |
| Moller & Schuman Co. | 3 |
| National Spring and Wire Co..... | 11 |
| Pierce Co., F. O. | — |
| Porter, H. K..... | 10 |
| Russell, Burdsall & Ward Bolt and Nut Co..... | 3d cover |
| Schubert Bros. Gear Co. | 3 |
| Smith & Co., Edw. | 3 |
| Spring Perch Co. | 11 |
| Standard Oil Cloth Co. | 9 |
| Standard Wheel Co. | — |
| Swinehart Clincher Tire & Rubber Co. | 4 |
| Timken Roller Bearing Co..... | 9 |
| Uebelmesser Co., Charles R. | 9 |
| Valentine & Company | 3 |
| Wilcox Mfg. Co., D..... | 11 |
| Wiley Co., C. A. | 2 |
| Woodman, Joel H. | 12 |

Please mention "The Hub" when you write.

FIFTH WHEELS—FORGINGS

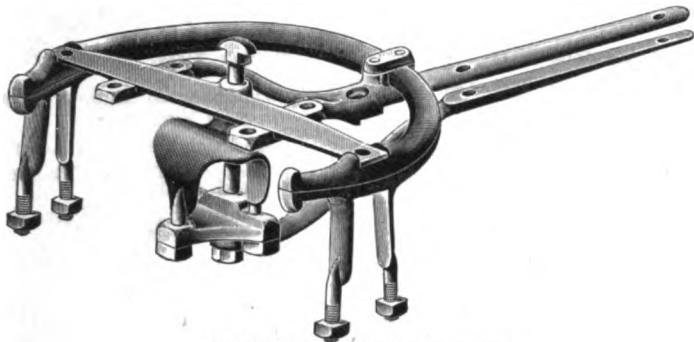

1908 Single-Reach Gear Set.

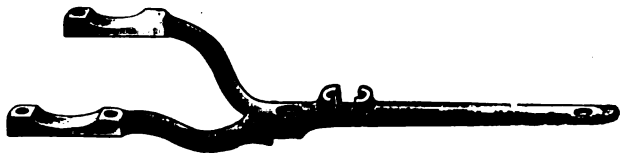

Detachable Fork Perch Connection Used in 1908 Gear Set.

Greatest Line on Earth

WHEN ORDERING GEAR SETS BE SURE TO GET THE GENUINE

Wilcox Rear King-Bolt Gear Sets

WRITE US FOR FULL PARTICULARS

THE D. WILCOX MANUFACTURING CO.

MECHANICSBURG, PENNSYLVANIA

Our Carriage or Spring Edge Cushion Frame



Is not an Experiment, but has been tried and stands the test.
We would like to quote you prices.
NATIONAL SPRING and WIRE CO.,
ALBION, MICH., and ST. CATHARINES, ONT., CAN.

Jones Wheels

BEST ON EARTH

KANTSAMORE

Phineas Jones & Co.
Newark, N. J.

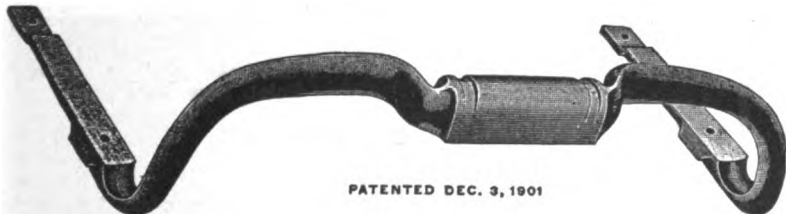

PATENTED DEC. 3, 1901

THE STANDARD BODY LOOP

NONE LIKE IT NONE EQUAL TO IT

A popular body loop, unequaled by any on the market.
For further information, address

The KEYSTONE FORGING CO., Northumberland, Pa

CARRIAGE SPRINGS

OF EVERY STYLE AND PAT-
TERN TO ORDER

Also Curtain Rollers and Concealed Hinges
EXCLUSIVELY FIRST-CLASS WORK
THE BEST THAT CAN BE MADE

SPRING PERCH CO.

BRIDGEPORT, CONN.

Please mention "The Hub" when you write.

A \$100 Typewriter for 17 Cents a Day!

Please read the headline over again. Then its tremendous significance will dawn upon you.

An Oliver Typewriter—the standard visible writer—the \$100 machine—the most highly perfected typewriter on the market—yours for 17 cents a day.

The typewriter whose conquest of the commercial world is a matter of business history—yours for 17 cents a day.

The typewriter that is equipped with scores of such conveniences as "The Balance Shift"—"The Ruling Device"—"The Double Release"—"The Locomotive Base"—"The Automatic Spacer"—"The Automatic Tabulator"—"The Disappearing Indicator"—"The Adjustable Paper Fingers"—"The Scientific Condensed Keyboard"—all

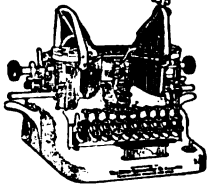

Yours for 17 Cents a Day!

We announced this new sales plan recently, just to feel the pulse of the people. Simply a small cash payment—then 17 cents a day. That is the plan in a nutshell.

The result has been such a deluge of applications for machines that we are simply astounded. Demands come from people of all classes, all ages, all occupations. The majority of inquiries has come from people of known financial standing who were attracted by the novelty of the proposition. An impressive demonstration of the immense popularity of the Oliver Typewriter. A startling confirmation of our belief that the Era of Universal Typewriting is at hand.

A Quarter of a Million
People are Making
Money With

The OLIVER Typewriter

THE STANDARD VISIBLE TYPEWRITER

The Oliver Typewriter is a money-maker, right from the word "go." So easy to run that beginners soon get in the "expert" class. Earn as you learn. Let the machine pay the 17 cents a day—and all above that is yours.

Wherever you are, there's work to be done and money to be made by using the Oliver. The business world is calling for Oliver operators. There are not enough to supply the demand. Their salaries are considerably above those of many classes of workers.

Write for further details of our easy offer and a free copy of the new Oliver catalog. Address

The Oliver Typewriter Company
310 BROADWAY NEW YORK CITY

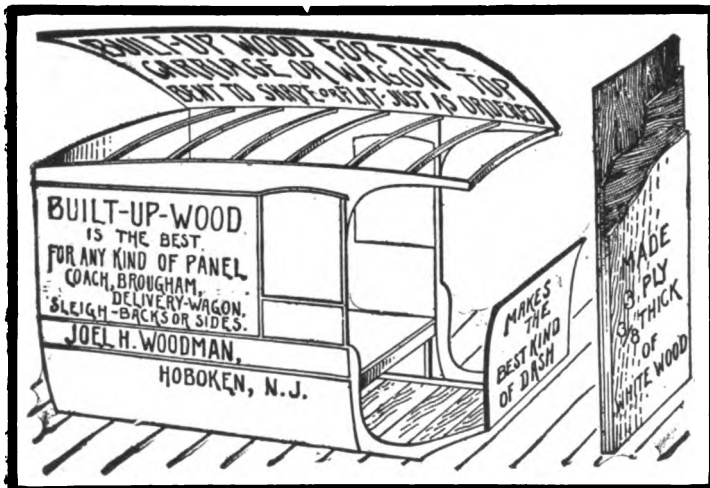

FITCH GEAR COMPANY

ROME, N. Y., U. S. A.

Manufacturer of over
40 STYLES of GEARS
From the lightest
Fine Carriage and
Buggy Gears to the
heaviest Express
Wagon Gears.

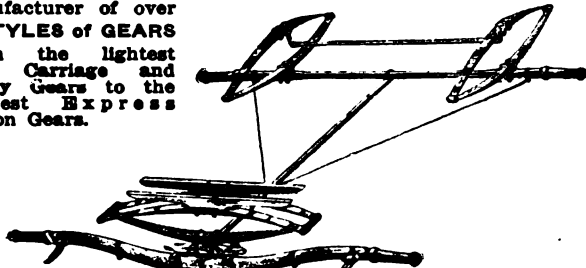

The Double Elliptic 3-Spring Gear is the most practical combination business and pleasure gear on the market, and is equipped with Wrought or our Common Sense Short Turn Fifth Send for our No. 24 Catalogue.

Advertisements Classified

The following list includes advertisers in THE HUB. Each advertiser is entitled to name under one heading only. An extra charge for name under more than one heading.

Automobile Parts.

LeCompte Mfg. Co., New York City.

Axles, Etc.

American Ball Bearing Co., Cleveland, Ohio.
Timken Roller Bearing Co., Canton, Ohio.

Bodies, Seats, Etc.

Woodman, Joel H., Hoboken, New Jersey.

Bolts and Nuts.

Columbus Bolt Works, Columbus, Ohio.
Russell, Burdall & Ward Bolt and Nut Co., Port Chester, N. Y.

Carriage Cloths.

Wiese & Co., Wm., New York City.

Carriage Forgings.

Eccles Co., Richard, Auburn, N. Y.
Keystone Forging Co., Northumberland, Pa.

Carriage Hardware.

Gifford & Son, John A., New York.

Carriage Goods.

English & Mersick Co., New Haven, Conn.
Gifford & Son, John A., New York.
Herbrand Co., The, Fremont, O.

Dashes, Fenders, Rails, Etc.

McKinnon Dash Co., Buffalo, N. Y.

Fifth Wheels.

American Roller Bearing Fifth Wheel Co., Brooklyn, N. Y.
Wilcox Mfg. Co., D., Mechanicsburg, Pa.

Jacks.

Hankinson, J. V., Franklin, O.

Lamps.

Gifford & Son, John A., New York.
Stevens & Sackett Co., New Haven, Conn.

Machinery and Tools.

Barnes Co., W. F. & John, Rockford, Ill.
Porter, H. K., Everett, Mass.
West Tire Setter Co., Rochester, N. Y.

Miscellaneous.

Standard Oil Cloth Co., New York.
Uebelmesser Co., Charles R. Bayside, New York, N. Y.

Rubber Tires.

Consolidated Rubber Tire Co., New York City.
Goodrich Co., B. F., Akron, O.
Goodyear Tire and Rubber Co., Akron, O.
Swinehart Climber Tire & Rubber Co., Akron, O.

Shaft Couplings and Anti-Rattlers.

Bradley & Son, C. C., Syracuse, N. Y.
Eccles Co., Richard, Auburn, N. Y.
Metal Stamping Co., New York City.

Springs and Gears.

Akron-Selle Gear Co., Akron, Ohio.
National Spring and Wire Co., Albion, Mich.
Spring Perch Co., Bridgeport, Conn.

Trimming Materials.

Stevens & Sackett Co., New Haven, Conn.

Varnishes, Paints and Japans.

Devos, F. W., and C. T. Reynolds Co., New York City.
Harland & Son, Wm., London and New York.
Masury & Son, John W., New York and Chicago.
Moller & Schumann, Brooklyn, N. Y.
McCore & Co., Benj., Cleveland, Ohio.
Murphy Varnish Co., Newark N. J.
Pierce Co., F. O., New York.
Smith & Co., Edw., New York.
Valentine & Co., New York, Chicago, Boston, Paris.
Wiley Co., C. A., Hunter's Point, New York City.

Wheels.

Crane & MacMahon, New York.
Gifford & Son, John A., New York.
Hoopes Bro. & Darlington, West Chester, Pa.
Jones & Co., Phineas, Newark, N. J.
Standard Wheel Co., Terre Haute, Ind.

Wheel Stock, Bent Wood, Etc.

Crane & MacMahon, New York.

Contractors

Automobile Parts

**PLAIN
FINISHED
MACHINED**

CASTINGS

B^{Brass}_{ronze} A^{luminum}_{utomobile} BRONZE

MANGANESE BRONZE

POPE'S ISLAND

Non-corrosive Metal, Silver and Gold; Best known metal

HAND CLOSE PLATING

Seven Colors, guaranteed to last the life of car, carriage or harness.

ELECTRO PLATING

Black, White, Gold, Silver, Nickel, Brass or Gunmetal

Contracts made with car manufacturers

Horse Bits

"If it's a bit, we have it"

Write for a pair of our
Cast Metal Silver or Gold
Horse Bit Cuff Buttons FREE

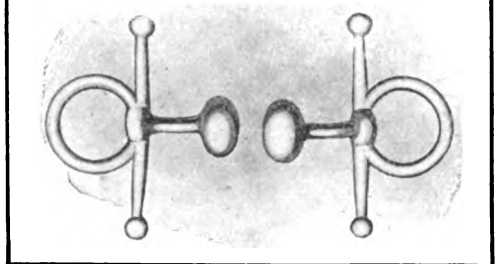

LeCompte Mfg. Co.

E. A. Whitehouse Mfg. Co.

} Inc.

OFFICE

110 Chambers St., New York

FACTORY AND FOUNDRY

44-50 Elm St., Newark, N. J.

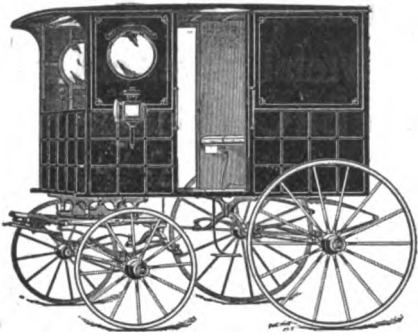

No. 112.—Milk Wagon.

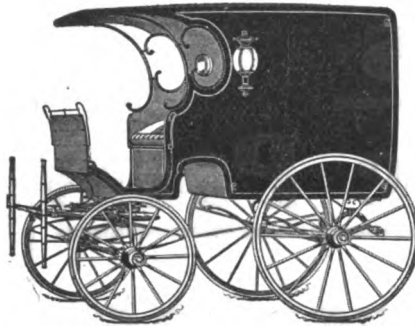

No. 111.—Altman Wagon.

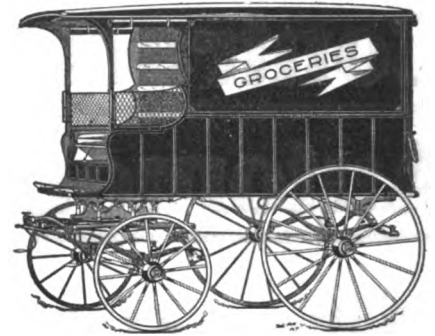

No. 113.—Grocery Wagon.

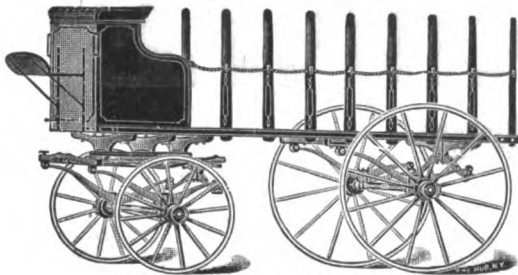

No. 122.—Flour Truck.

Electrotypes

of the vehicles presented on this page will be forwarded on receipt of

75 cts.

for each cut, to any address. Postage prepaid.

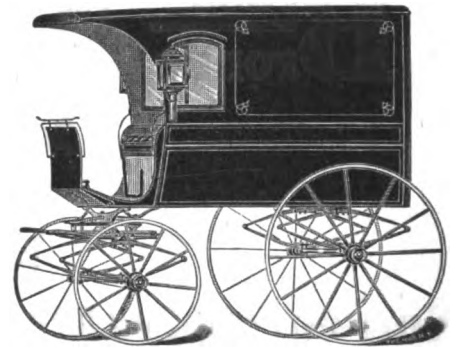

No. 115.—Delivery Wagon.

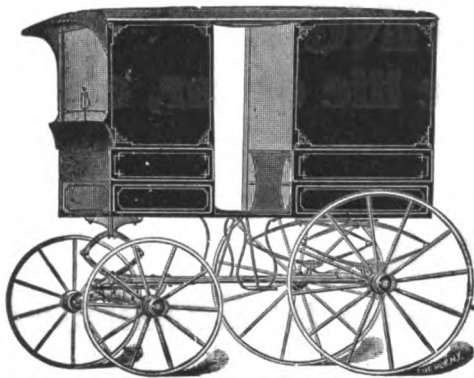

No. 116.—Milk Wagon.

Catalogue

containing nearly 200 illustrations of carriages, wagons, sleighs, and miscellaneous cuts will be sent upon application.

Trade News Publishing Co.
24-26 MURRAY ST.
NEW YORK

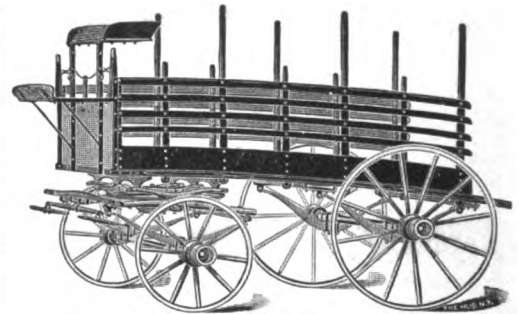

No. 117.—Merchandise Truck.

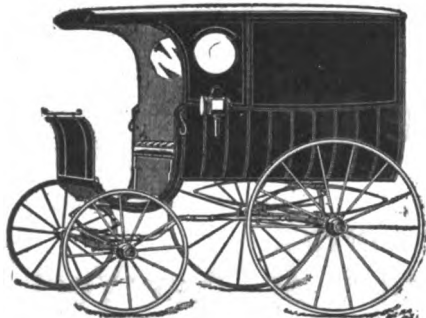

No. 114.—Delivery Wagon.

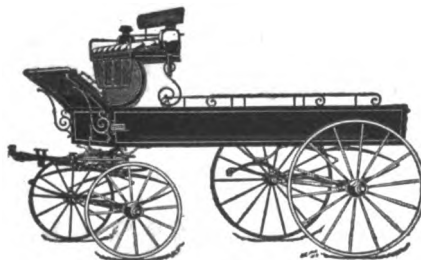

No. 124.—Delivery Wagon.

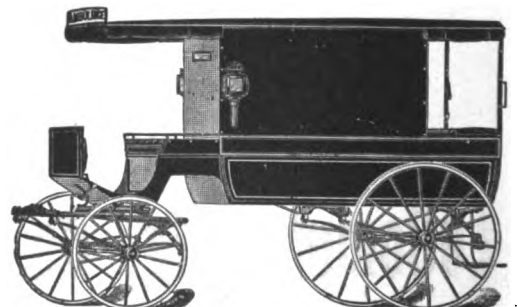

No. 118.—Ambulance.

Please mention "The Hub" when you write.



PLATE 5.
Low Wheel Runabout.

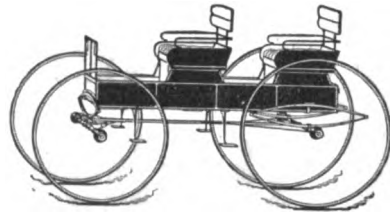

PLATE 10.
4 Pass. Beverly Wagon.

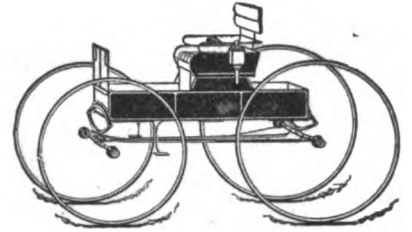

PLATE 15.
2 Pass. Beverly Wagon.

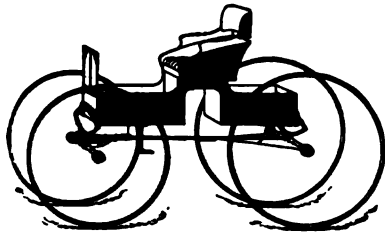

PLATE 20.
Cut-under Buggy.

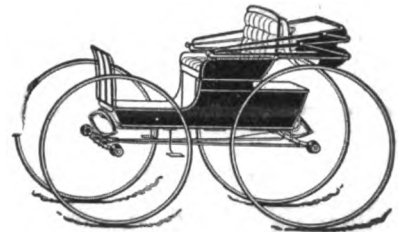

PLATE 25.
Corning Buggy.

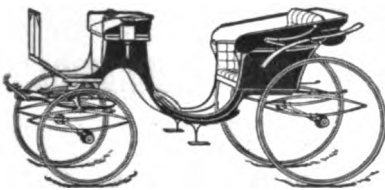

PLATE 30.
Panel-boot Victoria.

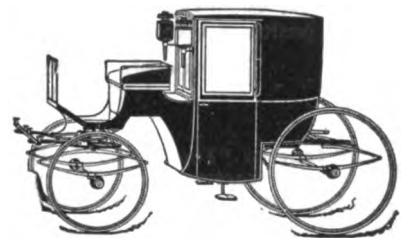

PLATE 35.
Brougham.

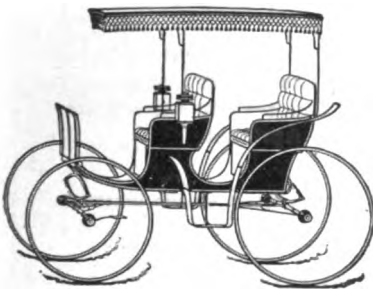

PLATE 40.
Canopy-top Surrey.



PLATE 45.
Elliptic Spring Buggy.



PLATE 50.
Ladies' Phaeton.

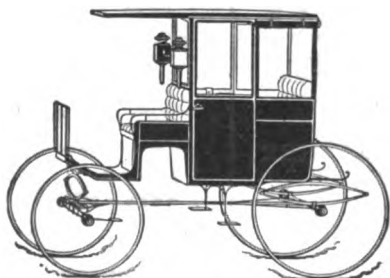

PLATE 55.
Station Wagon.



PLATE 60.
Doctor's Phaeton.

MAKE YOUR ADVERTISEMENT

ATTRACTIVE

By using these Advertising Cuts
at **75** cts. each.

The plates shown on this page are especially made for newspaper advertising, but, because of their clearness, are as well suited for the best printed magazines and stationery. They are

**Unique in Style
Correct in Detail
Attractive in Appearance**

and represent the most popular carriages of to-day. A special plate, the size and character of those on this page, of your own design and for your exclusive use, will be furnished for \$3.00. One or more sent at 75 cts. each, by mail (postage prepaid) on receipt of check or money order.

TRADE NEWS PUBLISHING CO.,
24-26 MURRAY ST.,
NEW YORK.

Please mention "The Hub" when you write.

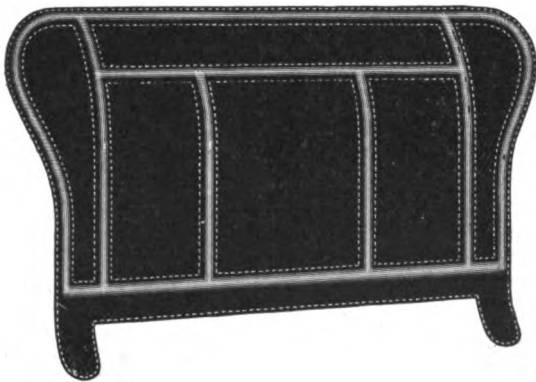

HIGH GRADE Dashes and Fenders

THE INDIANAPOLIS DASH CO.

INDIANAPOLIS

INDIANA

ESTABLISHED 1886.

Correspondence School of Carriage and Motor Carriage Drafting

A thorough, practical tuition is given through this correspondence school. The theory and practice of construction, bookkeeping, perspective. Many men now hold good positions through taking the courses of instruction.

Principal, THOS. MATTISON,
Hillside Avenue, Bitterne Park,
Southampton, England.

Author of "The Coach Body Makers' Guide," \$3.00; a practical treatise on "The Suspension of Carriages," "Bookkeeping," and other carriage building works.



Carriage Mechanics

Desiring to improve their present
Condition should attend the

TECHNICAL SCHOOL

FOR

Carriage Draftsmen and Mechanics

SUPPORTED BY THE

Carriage Builders' National Ass'n.

The object of the School is to teach men to design vehicles and make working drawings, and to otherwise facilitate their work in the shop. Only those men employed in carriage or automobile building or their accessory trades are admitted to its privileges.

The classes are conducted in three divisions, viz.: Corresponding, Day, and Evening. The former is open during the entire year, while the day and evening classes are in session only from October 1st to April 1st.

The tuition is moderate.

For prospectus and full particulars, write to the instructor,

ANDREW F. JOHNSON,

18 West Forty-fourth St.,

NEW YORK CITY.

The George R. Carter Co.

Manufacturers of

AUTO STRAPS A ESPCIALTY

CRANK STRAPS, HOOD STRAPS, TOP STRAPS
AND TOOL BOX STRAPS.

JOBBER IN

TRIMMING LEATHER, TOP LEATHER, LEATHER
CUT TO PATTERN FOR CUSHIONS

OR TOPS,

SHAFT LEATHERS, SHAFT STRAPS, POLE
STRAPS, ETC.

CONNERSVILLE,

INDIANA.

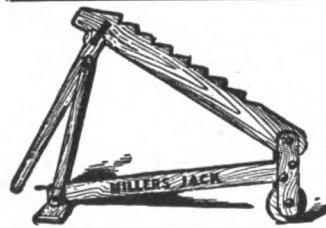

Made in four sizes, Nos. 1, 2, and 3.

JACKS FOR BUGGIES AND WAGONS

Miller Patent Wagon Jack
Made by

J. V. HANKINSON,

Successor to THOS. MILLER,
FRANKLIN, OHIO.

Write for particulars and prices.

Richard Eccles Co., Auburn N. Y.

Manufacturers of

Forgings: Carriage, Wagon, Automobile, Special

Send for Catalogue.

F. W. DEVOE & C. T. RAYNOLDS CO.

101 and 103 FULTON STREET, NEW YORK

Manufacturers of

F. W. DEVOE & CO'S
 { COACH COLORS
 VARNISHES
 BRUSHES
 SPECIALTIES

C. T. RAYNOLDS & CO'S
 { COACH COLORS
 VARNISHES
 BRUSHES
 SPECIALTIES

FOR PAINTERS, ARTISTS AND DECORATORS

All the brands and specialties of F. W. Devoe & Co. and C. T. Raynolds & Co. will be maintained separately as heretofore.

The Tires for Satisfaction

Goodyear Wing Carriage Tires and Goodyear Eccentric Cavity Cushion Tires with canvas guides are tires that wear—that give satisfaction and increase the dealer's trade. For all

GOODYEAR

tires are made of new, pure rubber, not of reclaimed "rubber" from the junk heap, nor any low grade. They sell easily because they save the user money—which pleases him—and he tells his friends.

Write today for free booklet showing how Goodyear Carriage Tires are built. Ask for sample section.

THE GOODYEAR TIRE & RUBBER CO., Canal Street, Akron, Ohio

| | | | | |
|-------------|---------------|-----------|---------|------------|
| Boston | Philadelphia | Cleveland | Buffalo | Denver |
| Los Angeles | New York | Chicago | Detroit | St. Louis |
| Cincinnati | San Francisco | Pittsburg | Atlanta | Washington |

Brazil Leather

FOR AUTO BUGGY TOPS

SEAT AND BACK SPRINGS,
 COTTON, NAILS, WADDING,
 MOSS, TACKS, WASHERS,
 HAIR, BUTTONS, REEDS,
 REED MOULDING,
 CLINCH BUTTONS

G. H. Lounsbury & Sons
 Cincinnati, Ohio



BOLTS Rivets, Carriage Makers' Washers
 and Burrs for all kinds of Vehicles
Russell, Burdsall & Ward Bolt and Nut Co.

Main Works, PORT CHESTER, N. Y.

Branch at Rock Falls, Ill.

Time Has Told the Story!

Service and satisfaction always follow our rolling stock

WHEELS

ALL KINDS—BEST QUALITY

Also RIMS and SPOKES

The Eberly & Orris Mfg. Co.
 MECHANICSBURG, PA.

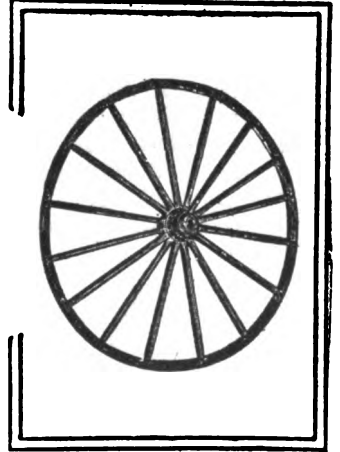

McKINNON DASH COMPANY.

TROY, OHIO.
CINCINNATI, OHIO.

ST. CATHARINES,
ONTARIO.

A

Should be used on every dash.
It will protect the top edge,
which is the first place to show
wear. :: :: :: :: :: ::

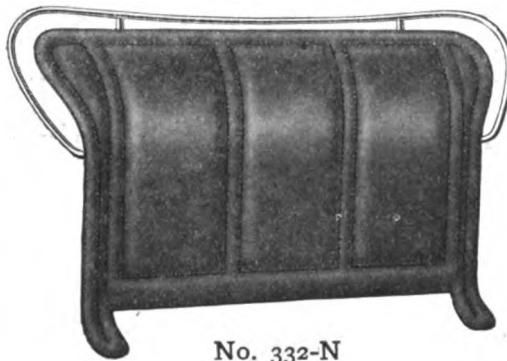

No. 332-N

A

Welded solid to the frame,
japanned, brass or nickel-plated,
adds several times the cost to
value of a vehicle. :: :: ::

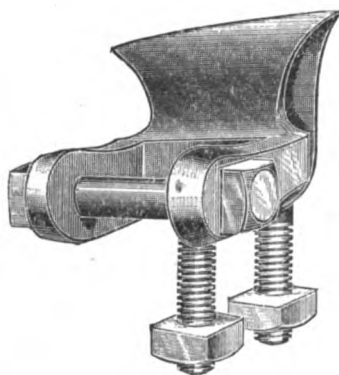

Skewed Shaft Couplings

**Regular or Oval Patterns
For High Arched Axles**

Furnished in rights and lefts for any height of arch. Oval Axle
Clips $\frac{1}{8}$ or $\frac{3}{4}$ width to match Oval Couplings. Bolts, Clips,
Couplings, Carriage Hardware and Special Forgings

Catalogue "H" and Prices on Application.

COLUMBUS BOLT WORKS, Columbus, O.

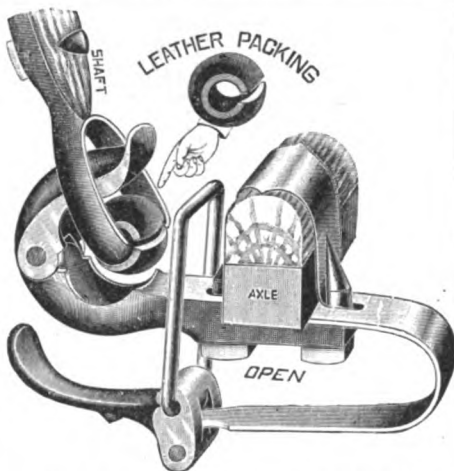
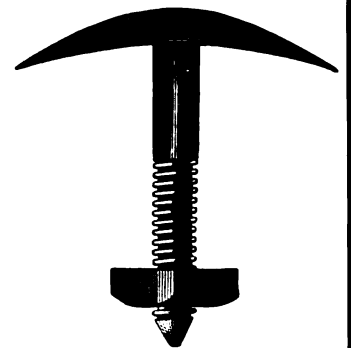

Placing the loop over the end of
the cap and drawing the thumb lever
back until it rests against the flat
spring closes the coupler, keeps it
closed, and takes up the wear of the
leather packing.



Unless a Carriage Coupler is furnished with a moulded leather bushing and steel spring JUST LIKE THIS it is NOT a BRADLEY.

THE BRADLEY Carriage Coupler

**All steel, Noiseless, Quick Shifting,
Ball Bearing.**

The **ONLY** Carriage Shaft Coupler that is furnished with a
One-Piece Moulded Leather Packing

A packing that will outwear any other packing ever made. It fits the ball and socket. It is held in place by a spring steel retaining ring. It may be put on and taken off in a jiffy, and it stays where it is put.

C. C. BRADLEY & SON
SYRACUSE, NEW YORK.

The Hub

Vol. LII.

MAY, 1910.

No. 2.

AUTOMOBILES
CARRIAGES
MOTOR TRUCKS
WAGONS

TRADE NEWS PUBLISHING COMPANY
24-26 Murray St., New York, N. Y.

Hoopes Bro. & Darlington Inc.

West Chester, Penna., U. S. A.

SARVEN

STAR or KENNY

Sweet Concealed Band

WOOD HUB

WARNER

HEAVY and LIGHT
for

CARRIAGES

WAGONS and

TRUCKS

IF YOU WANT THE BEST TRY OURS

The Output of Complete FRONT AND REAR AUTOMOBILE AXLES of this Plant Exceeds the Capacity of All Competition Combined.

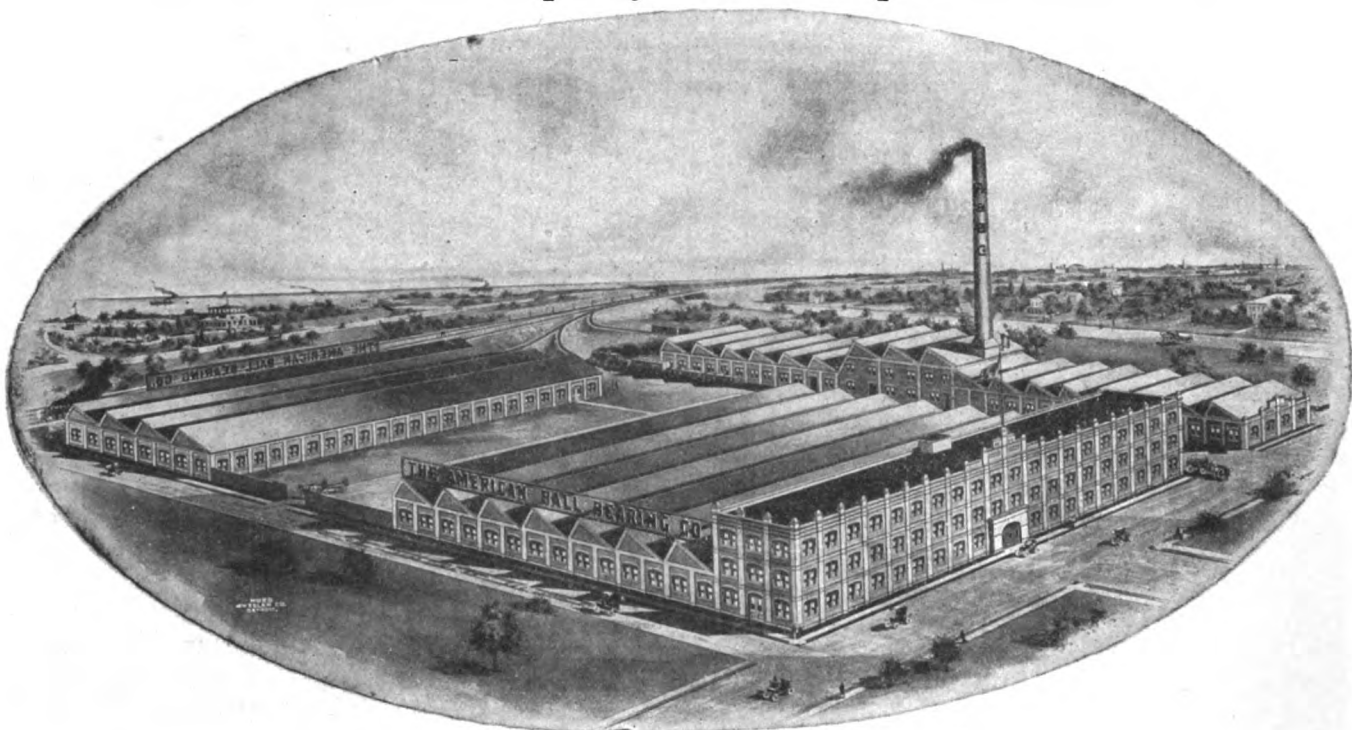

The American Ball-Bearing Co.,

L. S. & M. S. R'y and Edgewater Park.

CLEVELAND, OHIO, U. S. A.



CRANE & MACMAHON, (INCORPORATED)

8-10 Bridge St., NEW YORK CITY, U. S. A.

Sole Manufacturers and Exporters of the

HICKORY NUT,  ACORN,  and STAR  BRANDS OF

Carriage, Wagon and Automobile Wood Stock

FACTORIES:

ST. MARYS, OHIO.

RICHMOND, VA.

For Export Prices apply to the New York office.

Barnum & Bailey's Wagons and Chariots are finished with Murphy Palest Durable Body

"Because," says Mr. Otto Ringling, the company's purchaser, **"This varnish stays new Longest; and that makes it the Cheapest."**

Nothing on wheels tests varnish more severely than a circus wagon, except a motor car; which adds the racking vibrations to the cutting grits—MURPHY PALEST MOTOR CAR BODY is the varnish that endures both grit and vibration and **stays new.**

Let us send you, Free, a very useful little pamphlet,
"Varnishes For Carriages And Motor Cars"
Please address us carefully at 236 McWHORTER ST., Newark, N. J.

Murphy Varnish Company, Franklin Murphy, President The Varnish That Lasts Longest

NEWARK BOSTON CLEVELAND ST. LOUIS CHICAGO
Associated with Dougall Varnish Company, Limited, Montreal, Canada.

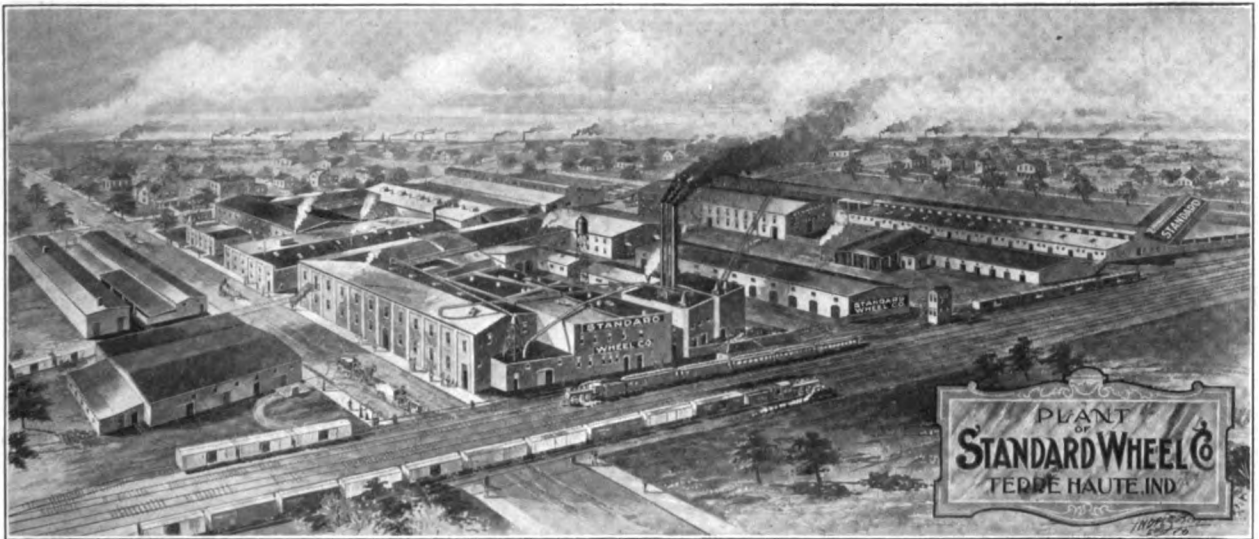

VEHICLE WHEELS AND WHEEL MATERIAL

Three Separate Departments [Light Carriage and Buggy Wheels
Heavy Express Wagon and Truck Wheels
Automobile Wheels

OUR GRADES ARE UNEXCELLED

WRITE FOR LIST.

Terre Haute, Ind.

STANDARD WHEEL CO.

Terre Haute, Ind.

JOHN W. MASURY & SON

Originators of

Superfine Coach and Automobile Colors

Acknowledged the Standard for Fifty Years

AND MANUFACTURERS OF

Fine Carriage and Automobile Varnishes

New York,

Chicago,

Minneapolis,

Kansas City

WILLEY'S COLORS

The RECOGNIZED STANDARD



C. A. WILLEY CO.

COLORS GRINDERS

and Manufacturers of Specialties in

CARRIAGE, AUTOMOBILE AND CAR

PAINTS

COLORS, VARNISHES, ETC.

HUNTER'S POINT, NEW YORK CITY

THE STANDARD Auto Door Locks FOR NINETEEN TEN

No. 999 Security Hook Lock
for Touring Cars.

No. 25 Security Hook Lock with
complete lever control
for Touring Cars.

No. 39 Rotary Lever Lock for
Limousines and other
closed vehicles.

Test them out NOW for the
coming season. : : : : :

English & Mersick Co.

New Haven, Conn.

Trade **VALENTIN** **ES** Mark
ARNISH

Don't Forget

VALENTINE'S
COACH COLORS

New Colors especially adapted to automobile body painting comprise

MARATHON GRAY and MOSS GRAY (entirely new)
OLYMPIC RED and BATH RED (dense and permanent)
THISTLE GREEN (absolutely permanent)
INDIAN BLUE (entirely new tone)

VALENTINE & COMPANY

New York Chicago Boston Toronto Paris Amsterdam

83 Years' Experience in Every Can



Edward Smith & Co.

CARRIAGE VARNISHES

Everything from the
 Bare Wood to the Finishing Coat.

CHICAGO

NEW YORK

THE SURPRISE IS YOURS

When You Open Your First Can of

MOORE VARNISH

Easy Working Perfect Flowing Long Lived
 Highest Quality Under Every Label

BENJAMIN MOORE & COMPANY

Varnish Makers

New York Chicago Cleveland Toronto

RUB ————— RUB ————— RUB

THAT'S THE EXPERIENCE SOME PAINTERS HAVE WITH A POOR RUBBING VARNISH.
 THEY RUB TILL THEIR HEART ACHES ONLY TO HAVE THE VARNISH SWEAT, OR ROLL
 UP UNDER THE PAD

XX Diamond Rubbing and Hard and Quick Drying Rubbing "A"

DRY HARD TO RUB IN TWO DAYS, WITHOUT SWEATING, ARE TOUGH AND THE BEST
 FOUNDATION FOR FINISHING COATS.

MADE BY **MOLLER & SCHUMANN CO.**

MARCY AND FLUSHING AVES.,

BROOKLYN, N. Y.

Please mention "The Hub" when you write.

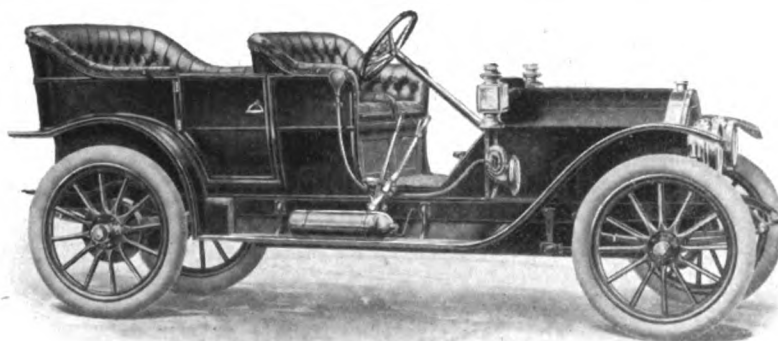

If you are to issue a catalog this Fall, why not get it from headquarters? The reputation of **The Cargill Company** for high class vehicle and auto work is unsurpassed by that of any other house in America. Write in your specifications and we will do the rest.

DESIGNING, ENGRAVING, PRINTING, BINDING UNDER ONE ROOF

The Cargill Company

Grand Rapids Engraving Company
Grand Rapids, Michigan

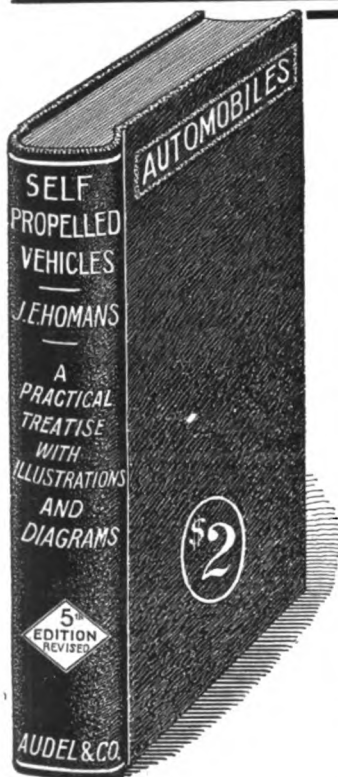

"Self-Propelled Vehicles"

Fifth Edition, Revised.

A practical treatise on the theory, construction, operation, care and management of all kinds of Automobiles.

By

JAMES E. HOMANS, A.M.

Contains 608 pages and upwards of 500 illustrations and diagrams, giving the essential details of construction and many important points on the successful operation of the various types of motor carriages driven by steam, gasoline and electricity.

This work is now the accepted standard, explaining the principles of construction and operation in a clear and helpful way. This book will be sent postpaid to any address in the United States, Mexico or Canada upon receipt of \$2.00.

Address

THE PUBLISHERS COMPANY

24 Murray Street, New York

FOR SALE

MANUFACTURING PLANT

A complete and fully equipped plant
for the manufacture of

Wheels, Spokes, Rims, Etc.

with a well established business and plenty of orders and material on hand to continue the business uninterrupted. Persons interested are requested to call or address

THE HUB,

24-26 Murray Street. New York City

Goodrich Solid Rubber Tires

Internal Wire Side-Wire Tires
Carriage Tires for Heavy Carriages

These products represent fifteen years of consistent development, and co-operation with customers. They have been distinguished always by the

Mark of Quality



Copies of the 1910 Catalogue will be gladly sent on request.

The B. F. Goodrich Company
Akron, Ohio

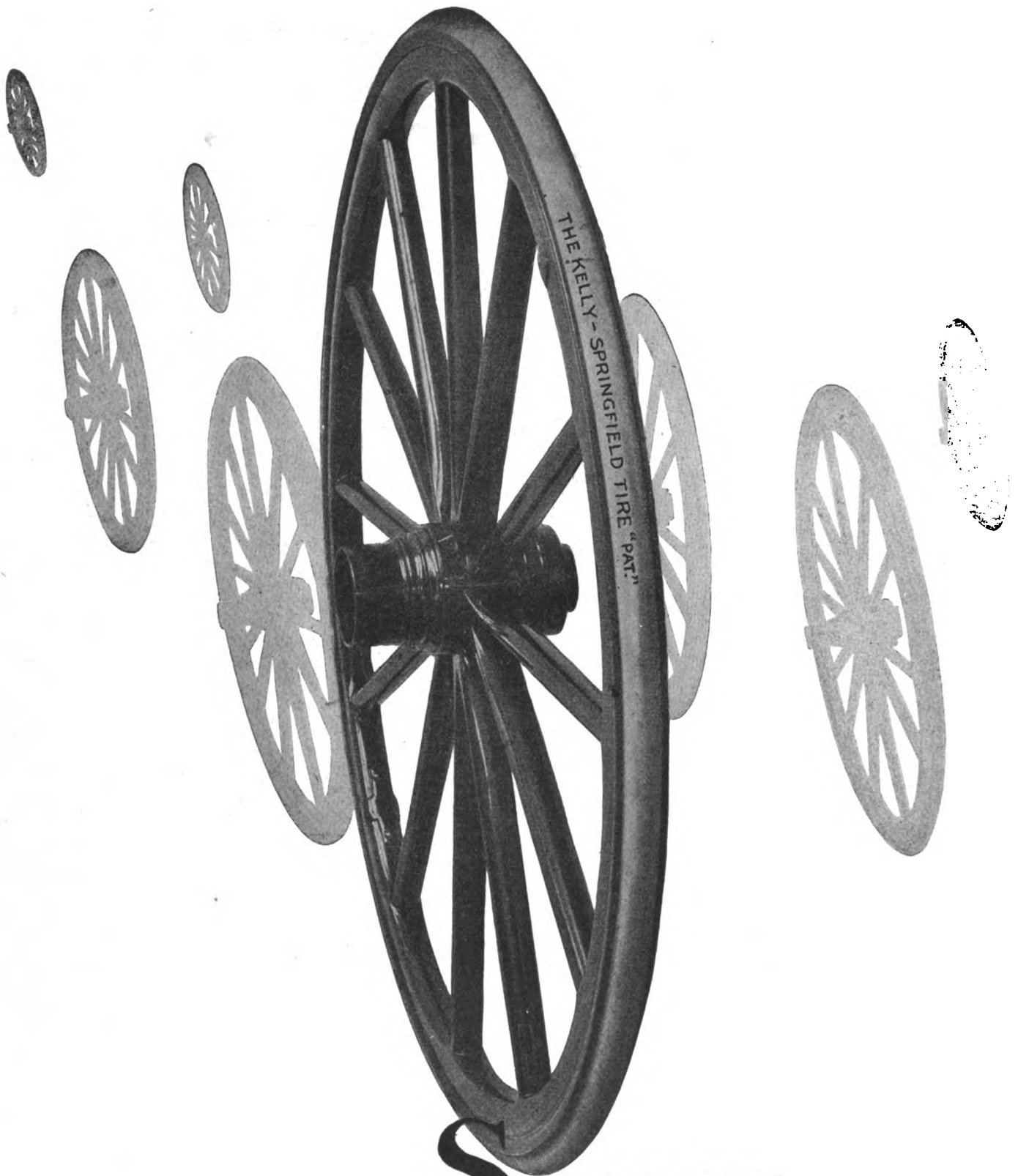

SOMEbody said that you never know how good a thing is until you see the imitation. WE say you never know how bad its imitations are until you see the
Kelly-Springfield Tire

The

Hub

Copyright, 1910, by the Trade News Publishing Co. of New York.

Entered in the New York Post Office as Second-class Matter.

Vol. LII.

MAY, 1910.

No. 2.

THE TRADE NEWS PUBLISHING CO. OF N. Y.

Publishers of THE HUB

J. H. WRIGHT, *President.*

G. A. TANNER, *Secretary and Treasurer.*

24-26 MURRAY STREET, NEW YORK.

JACOB H. KLEIN, *Technical Editor.*

Other Publications of Trade News Publishing Co.:

HARNESS (monthly)per year, \$1.00

AMERICAN HARNESS AND SADDLERY

DIRECTORY (annual)per copy, \$4.00

THE HUB is published monthly in the interest of employers and workmen connected with the manufacture of Carriages, Wagons, Sleighs, Automobiles and the Accessory trades, and also in the interest of Dealers.

Subscription price for the United States, Mexico, Cuba, Porto Rico, Guam the Philippines, and the Hawaiian Islands, \$2.00, Canada, \$2.50, payable strictly in advance. Single copies, 25 cents. Remittances at risk of subscriber, unless by registered letter, or by draft, check, express or post-office order, payable to the order of TRADE NEWS PUBLISHING CO.

For advertising rates, apply to the Publishers. Advertisements must be acceptable in every respect. Copy for new advertisements must be received by the 25th of the preceding month, and requests to alter or discontinue advertisements must be received before the 12th day of the preceding month to insure attention in the following number. All communications must be accompanied by the full name and address of writer.

FOREIGN REPRESENTATIVES:

FRANCE.—L. Dupont, publisher of *Le Guide des Carrossiers*, 78 Rue Boissiere, Paris. Subscription price, 15 francs, postpaid.

GERMANY.—Gustave Miesen, Bohn a Rh. Subscription price, 12 marks, postpaid.

ENGLAND.—Thomas Mattison, "Floriana," Hillside Avenue, Bitterne Park, Southampton. Subscription price, 12 shillings, postpaid.

Those "Classy" Creations.

The engineer who makes gas engines, believing he is also a complete car builder, through the journals that stand for his contention, is just awaking from the dream state in which he has thus far enjoyed a peace (and plenty) which almost passeth the understanding.

Having seen some not too well considered examples of coach builders' work wherein more passenger room has been gained at the expense of the running board, there seems to be a growing idea that engineer-made motor bodies are susceptible of further improvement. Somehow these "classy" affairs we hear so much about in the jargon of the cigarette-salesman who depends upon a word to epitomize his want of technical knowledge, fail to satisfy when compared with the products of the coach builder. After many, many years, when the engineer emerges from his chrysalis state into full fledged development, he will really understand the art of body building. He will then appreciate that he will do better to remain a worker in metal. The journals that stand as his sponsors will also become much better judges, and be able to discern at a glance something that is a carriage and something simply classy.

The "Tire" Situation.

Since the makers of rubber tires for use on motor cars have agreed to agree, it has created a "situation" as the car maker views it, so he is going to get together through his licensed association and talk it over.

This is the way he puts it in his official announcement:

"The tire situation, which is extremely critical, and one that demands consideration at this time by the entire membership, affects every manufacturer. In this connection it is requested that each board member, before attending the meeting, will endeavor to investigate the rumor that there exists among certain tire manufacturers of this country, an understanding or "gentleman's agreement" to increase the price of tires and to refuse to sell or deliver to manufacturers at this time, any tires for 1911 equipment.

"It is hoped that you will obtain all the information available relative to the tire situation so as to be prepared for a discussion at the meeting which promises to be one of the most important (from a manufacturer's point of view), that the Association has held."

The "situation" ought to develop which ox is being gored.

The Question of Suspension.

It is very reasonable to look for controversy or difference of opinion in spring suspension as the evolution of the motor car comes finally to those refinements of construction that make for more comfort for the passenger, and more artistic treatment of the lines of the body.

At first the engineer who was responsible for the power plant and the chassis was too absorbed in making the car move to think much about how or where the comfort of the passenger came in. To him a spring was a spring, probably, and like the primrose by the river's brim a simple primrose it was to him, and it was nothing more.

To the coach builder body suspension was in the primer department of his art. For years his study was to bring about ease and comfort as component parts of his vehicle of chief value, and there was no idea in springs that he had not tested and proved. When he had, finally, to make the bodies for cars he found much to criticize, also had many suggestions to offer to the engineer who was less well informed on the subject.

The main trouble is, of course, with the rear springs. As soon as objections were forthcoming, there were also a number of kinds of suspension attempted. There are now to be seen the horizontal, half-elliptic, double elbow

side spring, full and three-quarter elliptic, and the platform spring. Certainly these cannot all be the best for the purpose in view. There must be at least one very best.

The side spring forms an easy connection between body and axle, as the weight is applied at the end of the arms, securing a balance on the axle.

The idea of the three-quarter elliptic is that the top elbow makes an easy and sensitive connection between body and spring, which should be a good absorber of shock. The fault so far seems to consist in making the top leaves so rigid that the idea of sliding leaf contact, which is the idea contained in a good spring, is lost.

But the scroll end spring so often seen, would seem to be about the worst practice of any. It is quite responsive to vibration, but makes the very weakest sort of connection, and is then at a part where the load support is had by a quick, sharp curve of a single plate. They ought to break, and they fulfill the fondest expectations in this particular, much to the satisfaction of the repairer.

All of the kinds of springs enumerated rise above the floor of the chassis, and when it is a question of a wide body that is to be suspended, it has to be cut out to allow for the spring play, spoiling, or at least marring some of its fine design in the side sweeps.

Lumber High.

Lumber suitable for body work has not escaped the attention of the high price movement. Some who have to use it acted on the thought that controlled the minds of those who poked fun at Noah, saying it was not to be much of a shower after all. Material suitable for bodies is not fundamentally scarce, but it has been artificially made so. The price is high and advancing, and it is so controlled that it is difficult to procure in a competitive market.

If metal was not a component part of bodies of very extended use, wood might become almost prohibitive in price. The steadily rising scale of commodity prices must soon, we should judge, reach a plane where the rise will defeat its ends by making manufactures too difficult to profitably pursue. Of course, such a plane will not be reached, or if attained, it cannot be maintained. We hope such a phase of the price movement is now manifesting itself, as a modification of price its raw material would be of great advantage to the vehicle industry.

The Roads.

It used to be good roads, that is roads made of any good material in any one of several approved ways. The motor car soon demonstrated it could pull up the best macadam ever laid. Slag and cement seemed to hold down the road until the traction engine put in an appearance. Now they are running railless trolleys in some countries.

The question is now, what are good roads? There is a demand for some brand that can withstand the onslaught.

Cost Accounting.

The very wide attention given to the subject of accurately learning what goods cost, and at what price they should be sold to yield profit, if well handled and understandingly applied, will tend to reduce the number of failures reported by commercial agencies.

According to reports some of those whom it is proposed to benefit by the adoption of a cost accounting system seem to have missed the point. They have concluded it is a campaign of education for the purpose of familiarizing them with the idea of raising selling prices, preparatory to an advance by manufacturers in wholesale prices. It is hard to understand how such an idea could find lodgement.

In time, we think, this wide-spreading movement will be appreciated for what it is worth, and when that time comes the estate of the dealer in vehicles will be much improved. Guessing at prices is a dangerous game, with the percentage fatally against the guesser in the long run.

Re-doing Auto Bodies.

A sapient journal that thinks it represents (?) the carriage builder is as full of advice as a bank is of money, which it pays out to the carriage builder. It has undertaken to show him that he can muss around and find second-hand cars that have been taken as exchanges in sales by makers of new cars, and that he can re-vamp these second-hands and create quite a business in the "old clo'" line. This, the journal says, will help out greatly if the efforts of the carriage builder to get an agency from some car maker meets with failure.

One must suppose from such fatuous advice that the carriage builder has fallen to the estate of Lazarus, and is in the market for crumbs. The carriage builder must feel complimented to find a spokesman in this self-appointed representative (?) of his business.

How Many Are There?

Those who have taken a pad and pencil and made a few figures are prepared to announce that the total number of auto builders in the country count up to 150. Of these, thirty-five have made Michigan their happy home, where the thirty-five turn out 140,000 cars a year.

Detroit has welcomed twenty-three of Michigan's thirty-five, and these industrious concerns are responsible for 85,000 cars.

Detroit pays out one million as a weekly wage to the 58,000 workmen helping to construct autos and parts. The sixty per cent of total car output, which Detroit claims, makes that town the superlative center of the business. It is not equalled in the world.

Lots of people tell us not to worry. Can you name a man who has accomplished anything worth while without worrying? If you know a man of this calibre, you know an unusual person. We are not all so constituted. The thing is to keep worry from interfering with energy and tact.

Vehicle Fashions for May 1910

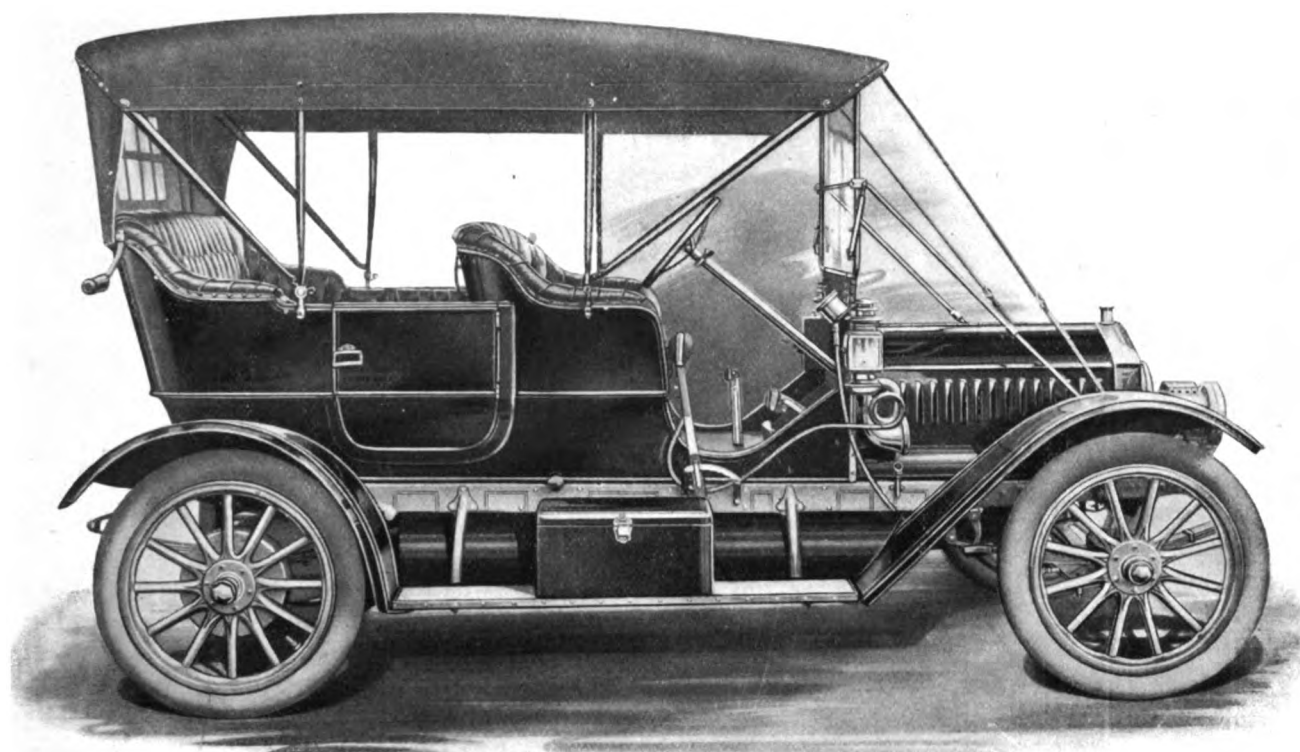

FOUR-PASSENGER TOURING CAR.
Built by Buckeye Manufacturing Co. (Described on page 58.)

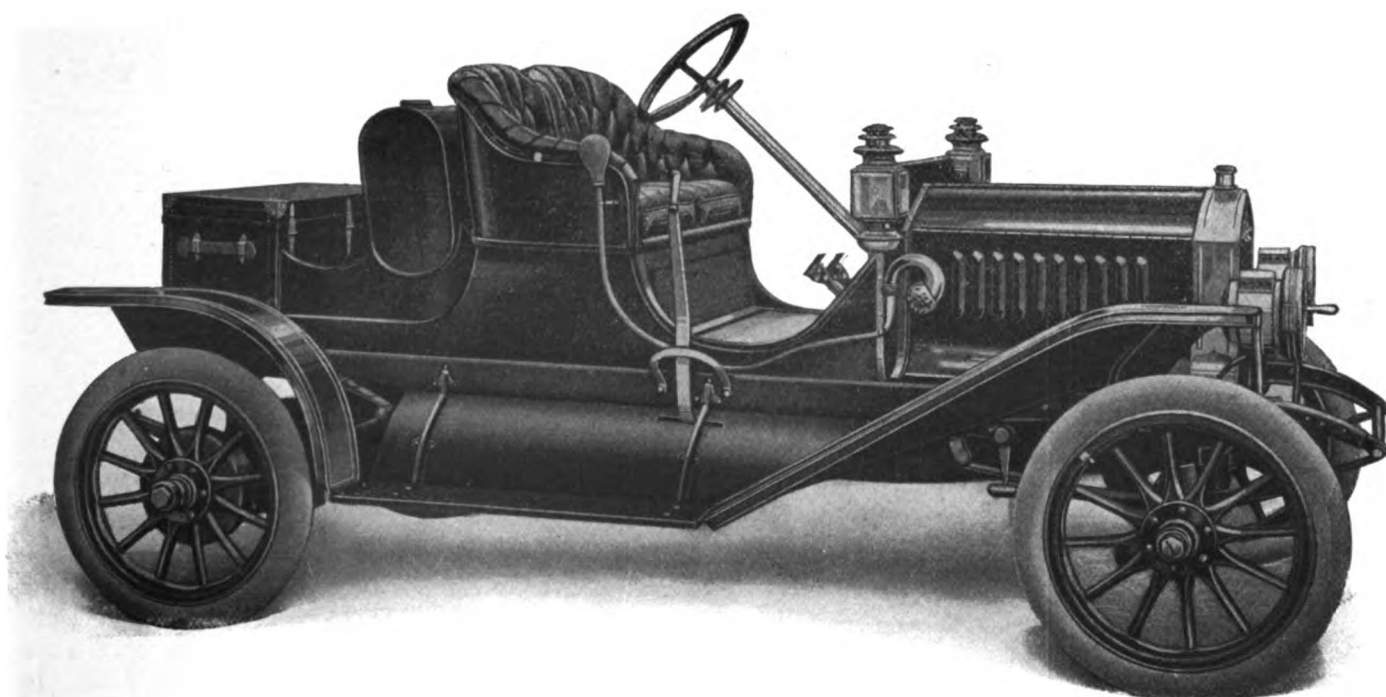

"THE LAMBERT," A TWO PASSENGER TOURING CAR.
Built by Buckeye Manufacturing Co. (Described on page 58.)

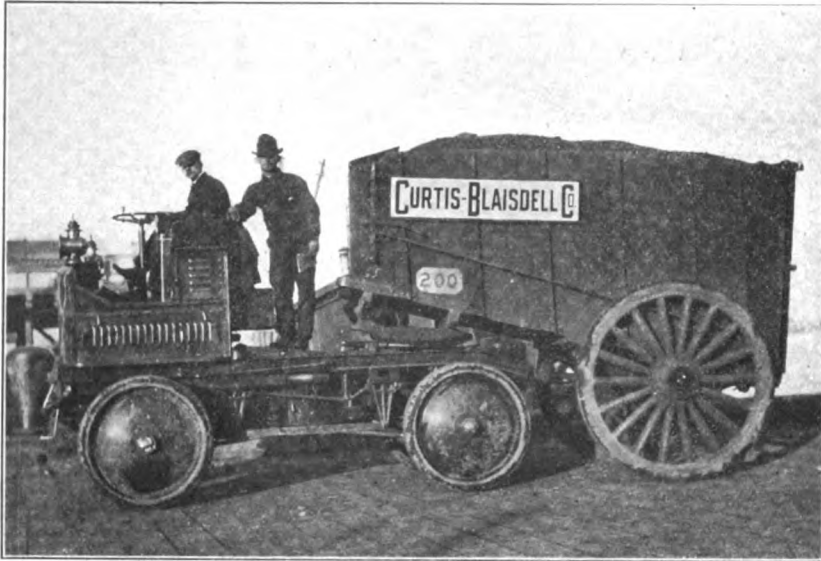

**COUPLE-GEAR
PLATFORM CHASSIS.**

**COUPLE-GEAR
AS INTEGRAL
PART OF WAGON**

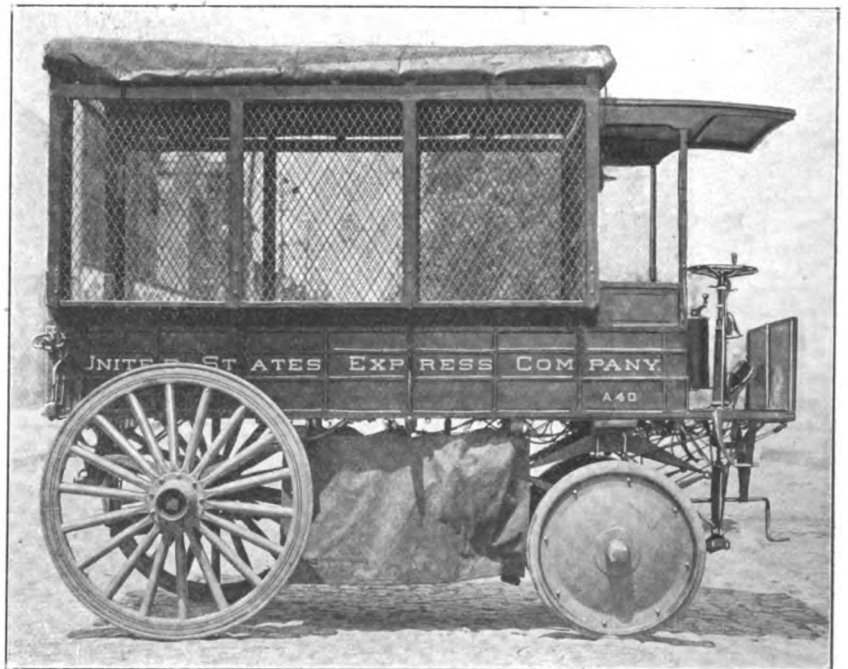

**COUPLE-GEAR
CHASSIS COMPLETE**

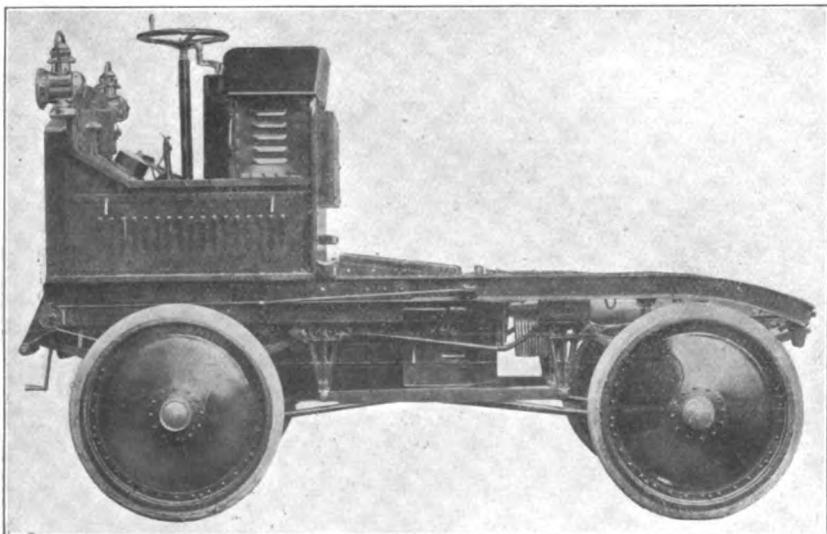

COUPLE-GEAR COMMERCIAL TRUCKS
Built by Couple-Gear Company, New York.

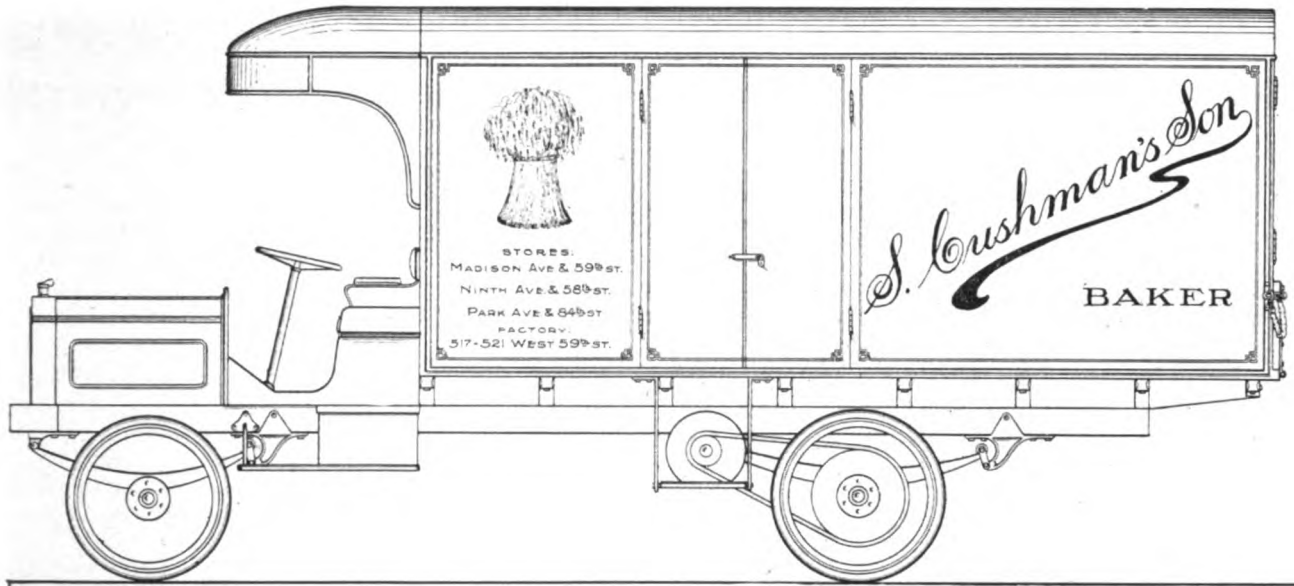

BAKER'S LARGE DELIVERY MOTOR WAGON.
(Described on Page 58.)

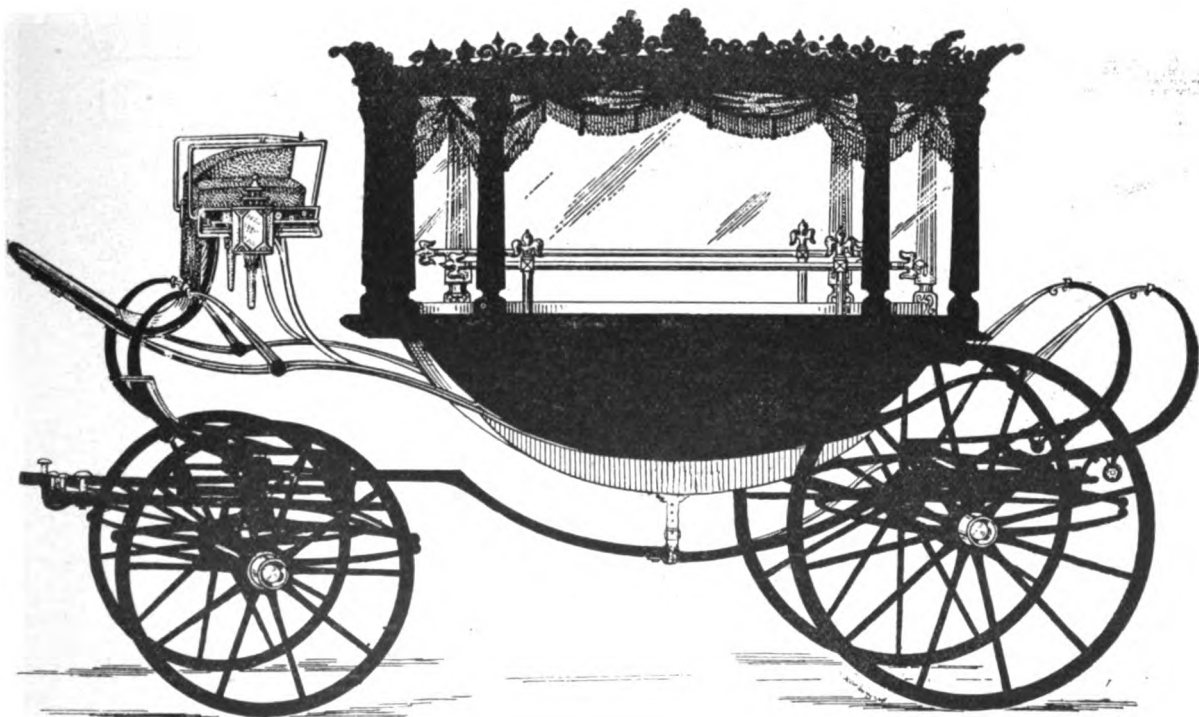

CANOE LANDAU HEARSE.
(Description on Page 37.)

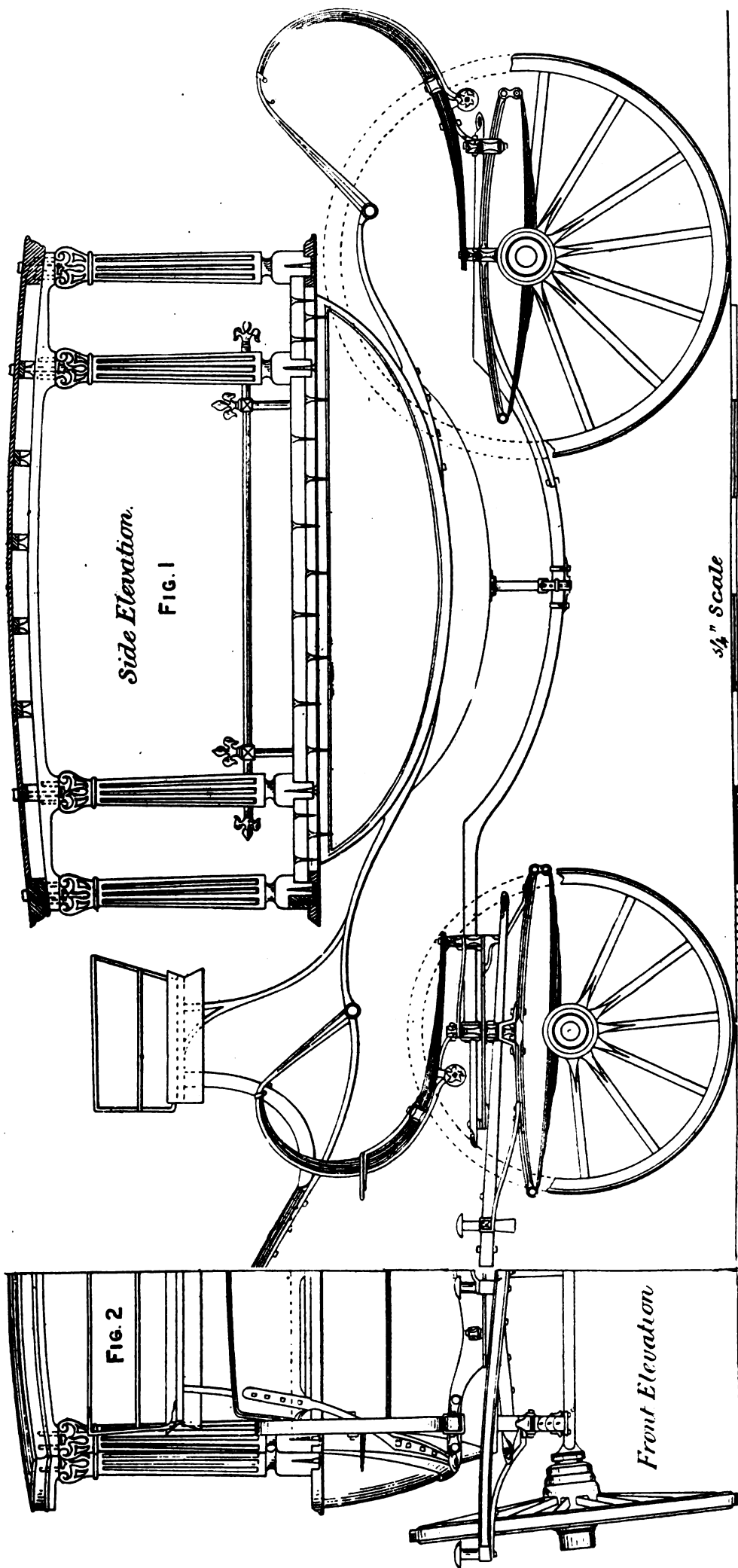

Side Elevation.

FIG. 1

1/4" Scale

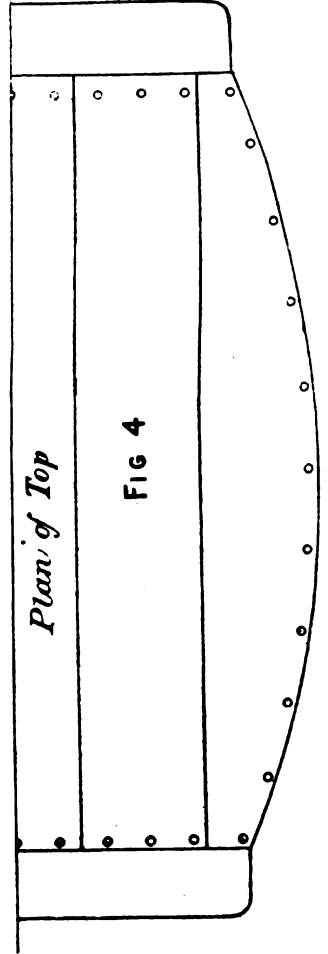

Plan of Top

FIG. 4

CONVERSION OF A LANDAU TO A HEARSE.
(Described on Opposite Page.)

Wood-working and Smithing

LANDAU HEARSE.

(Illustrated on Pages 35 and 36.)

We illustrate from the pages of Cooper's Vehicle Journal a conversion design that gives such an easy, comfortable "last ride" that we think the one-passenger occupant ought to perform a miracle by rising up and calling the idea blessed. It is interesting also because it makes a really graceful appearing hearse. With the fashion plate we also show the working drawings, which are thus described by the journal quoted.

The raised ends of the elbow line should be cut straight through at a height level with the top of the door pillars. On reference to drawing it will be seen that the landau in question measures on the elbow line 5 feet 10 inches when cut down to the point indicated above. As it is necessary to make a plat-

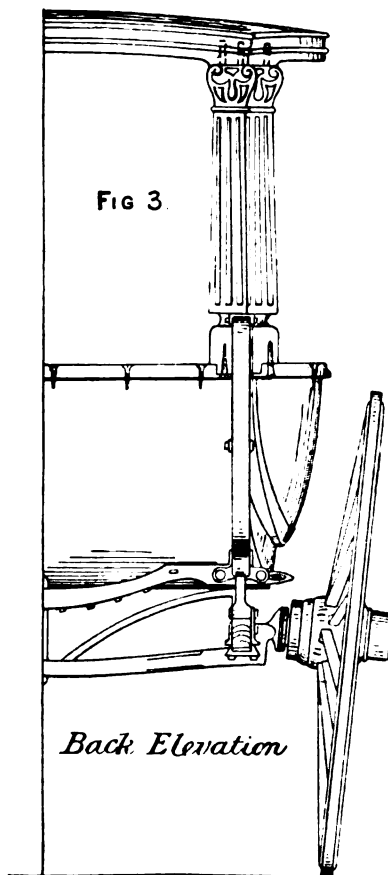

form for the coffin no less than 7 feet 2 inches in length, a platform will have to be placed on top of the body. This should be constructed as shown in Fig. 4. The hearse standing pillars are dowel framed, and to the shoulders of the pillars the top rails are bound with nuts and bolts. This arrangement is apparent in the side elevation and back and front views. The ordinary framework of the landau is strong enough for the purpose, more especially as it is held rigidly in position by the deck. The alterations necessitated by the cutting down of the quarters must, however, be made. Where the sweep up is not very great, the framing can possibly remain unaltered; but where it is extreme, it will be necessary to put new framing pieces to the top side. If this is done it will be better to have top framing pieces run right through from the back to the front of the body. If they are not altered it is not necessary to frame the door top.

SHOP HINTS.

A satisfactory way to dress and temper a hammer is to heat the hammer to a red heat and while hot rasp it into shape. Avoid using a hammer on it at all, as that part of it which is battered or broken out of shape while cold is very likely spoiled as far as the grain of the steel is concerned. If a nice finish is wanted, allow the tool to cool down slowly after hot rasping and finishing up with a smooth file. To temper it get an old tea kettle and heat the hammer to an even red heat all over (not too hot) and holding it over the slack tub pour a steady stream of cold water from the spout of the tea kettle onto the center of the hammer's face until that end of the hammer is black, then quickly turn the blade end under the water of the slack tub about $\frac{3}{4}$ of an inch, and treat the other end the same way. The idea is to get the center of the face just as hard as glass and the edges not hard enough to be brittle and yet hard enough to not batter down.

Cold chisels, hot chisels, etc., are tempered by "draw tempering," which consists of heating an inch or so of the cutting edge to a red heat and cooling the end by sticking $\frac{3}{4}$ inch in the tub or can of water until cold, then rubbing bright with sandstone or sandpaper and holding in the hand until the heat runs down from that portion of the tool not cooled. This is called color tempering, but the color is not to be depended upon absolutely, as the difference in steels allows of no definite rule. A better plan is to test the edge with a sharp file and when this will just cut the edge of the tool, cool it off, stopping further softening. In tempering such tools water should be warmed enough to take the chill off of it, and if milk warm is all the better and much less likely to check the steel. Drill bits for iron and steel may be tempered the same way, but left somewhat harder. In the dressing and tempering of all tools and tool steel, great care must be used to heat slowly and in a deep fire; to work the steel as little as possible with the hammer and at a heat not yellow nor too low; to never cold hammer the steel; to where practicable allow the steel to cool down slowly and dry and out of a draft once before tempering so as to rid it of strains. To never heat above a cherry red, as many a good tool is utterly ruined by one over-heating and to "restore" such a piece is about as practicable as mending a broken egg.

WOODWORKING SAFETY PRECAUTIONS.

A contributor to the American Blacksmith writes an account of the precautions that, if observed, will minimize the liability of accidents. He says:

Woodworking machinery generally is exceedingly dangerous, and in order to safeguard the operators working upon saws, jointers, shapers and the like, it is necessary to exercise utmost care and to utilize all practical safeguards. Exposed belts and pulleys in any department of the general shop are dangerous, but they are especially so in the wood department, by reason of the high speed at which they are usually operated. It is, of course, necessary that these exposed belts and pulleys be guarded. Suitable guards can usually be constructed in the shop at little or no cost. If the part or parts thus guarded must needs be easily accessible, the guards may be so made as to be easily removable.

Another simple precaution that may often save a hand, an arm, or even more serious injury, is the use of rubber mats before the machines. The floor of the woodworking shop is usually very smooth and oftentimes slippery, by reason of the smoothing and polishing action of the sawdust under foot; but if a rubber

mat of reasonable size is secured to the floor before each machine the machine operator is not so liable to fall into the machine.

The circular saw has probably claimed more fingers and thumbs as its toll than any other machine in the wood shop, and it is, of course, strongly urged that a suitable guard be placed on this machine. There are several efficient saw guards upon the market, and the woodshop operator will do well to get one or more, according to his equipment.

Another "little trick" usually laid to the circular saw is the cramping of the saw, its stoppage, and consequent throwing of its belt. This may be prevented by the use of a "riving knife." This is simply a piece of sheet metal—steel preferred—placed im-

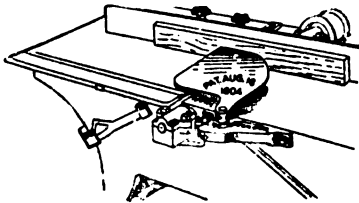

A PRACTICAL GUARD FOR THE JOINTER

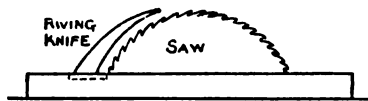

CRAMPING IS PREVENTED BY THE USE OF RIVING KNIFE

mediately back of the saw, so as to spread the cut as the work is pushed along. The ends of the riving knife should be slightly thinner than the saw, while the outer edge is slightly thicker.

In no case should a circular saw be allowed to run unguarded while the operator is away from it. It is best to stop the saw when it is unattended, but if it should be allowed to run for any time at all without work a box placed bottom side up over the saw will effectually guard against any person falling upon it accidentally in passing.

Band saws should have both their upper and lower wheels guarded, either with a wooden housing, sheet metal or wire mesh. The wood workman will probably find the wood housing the cheapest, for obvious reasons, and when it is correctly attached it is just as serviceable as the metal or mesh. For the guarding of that portion of the saw opposite the cutting table a tube may be used very effectively. The guard and guide above the table should always be as close to the table as the work will permit. This not alone for safety, but for the prevention of saw breakage as well.

There are several styles and makes of guards for planers or jointers, and the dangerous nature of this machine makes their use most necessary. Wood shapers are also easily safeguarded by various guards now upon the market and it is best to get one or the other of these guards rather than run the risk of serious injury.

TO PREVENT RUSTING OF MACHINERY.

An old formula, but a good one, to prevent the rusting of the iron parts of machines, particularly those exposed to the weather or to changes in temperature, is as follows: Take one ounce of camphor and dissolve in one pound of melted lard. Take off the scum. Mix in as much finely powdered black lead as will give the mixture an iron color. The machinery to be treated should be carefully cleaned and then smeared with the mixture. After twenty-four hours rub clean with a soft linen cloth. Under ordinary conditions the iron will then be free from rust for several months.

Kriwenak Bros Co., Denmark, Wis., hardware, implements, vehicles, etc., increased capital from \$15,000 to \$25,000.

FITTING A HOOD TO A LEVEL-SIDED TWO-SEATED MOTOR.

The open car is not a strictly complete vehicle unless it is fitted with a hood, which, in a measure, makes it a close and open car in one. Of those turned out without this fitting many find their way back to the factory, to have hoods fitted to them.

The drawing shown here is that of a level-sided torpedo body in section, to carry two, and the hood as it is fitted, is made to take off and on at the hinge stay.

The hood is made with three bows with quick bent corners, the front horizontal bow hinged to the front bow with a sliding socket and universal joint. The bow takes its bearing upon the top of the windage glass frame, which is made to be pitched at any angle desired in both bottom and top halves.

The experience of motorists is continually crying for something better than that which has gone on before. They are the practical experimenters who are driven to explain their wants in the stern school of practice, which is not confined to one particular in motor fitting, but applies to every part in construction on which is hinged the necessities of utility.

The hood under treatment is of simple construction. The front bow should be kept near to an upright angle, so as to keep the space in getting in and out of the body as clear as possible.

The side joints may be made of mild steel, which will admit of their being made of a lighter forging than iron. The hinge to take the bows is forged with a spindle and passed through a hole in the pillar iron and screwed up on the outside. The side joint may be left on the bow prop, but made to take of the body prop at A. Thus the fixings are simple, effective and all that is necessary. When the hood is off the windage glass frame, its top half can be hinged back to the bottom half, and thus form a protec-

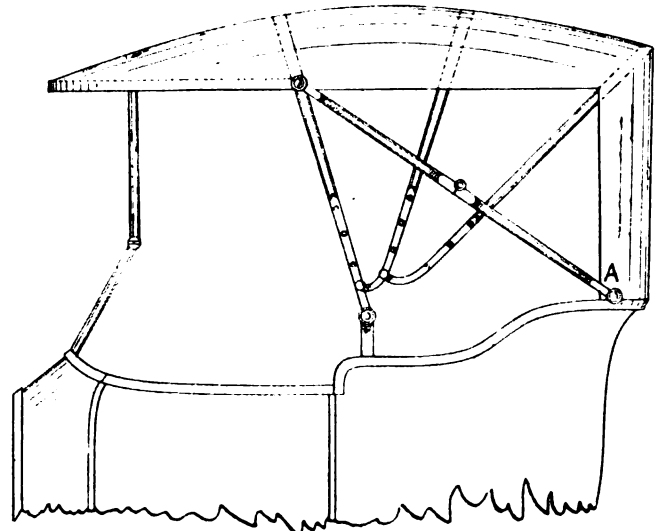

tion to the occupants, or the frame can be hinged to an upright position and stayed there with stop-joint hinges, which also allow of the screen being held at any angle.

In taking the measurements for the hoop bows, all that is necessary is the width over body, and depth from seat, and to allow for a five-inch rise on the curve of the roof. The front horizontal bow is made with quick bent corners, and dressed up square.

A distance of 44 inches from the seat to the horizontal line of the hood, with an additional five inches for rise on the curve, will cover all requirements as to head room in the hood. The bows are generally finished in the natural wood; that is, only varnished. The hinge fittings are plated to contrast. The side joints are painted and finished in japan, but no plating.

A hood in good style calls for taste and judgment to harmonize, as well as for high mechanism to make it effective.

The covering is mostly of drab, or fawn colored waterproof twill material, and looks quite smart when turned out in high finish.

PROPER METHOD OF FRAMING UP TOURING CAR SEATS.

One of the chief difficulties encountered by woodworkers when constructing the wood framing for automobile seats having a metal panel, is the making of the round corner of the upper framing.

Many methods are used, perhaps the most common being that where the woodworker employs three pieces, the right and left side of each having a little of the round and the back piece having the balance or compliment of the framing. These three pieces are butted together, the stock on all pieces being thinned to a feather edge at the joint, a condition that naturally comes from the rounding of the pieces from the outside. A corner piece is

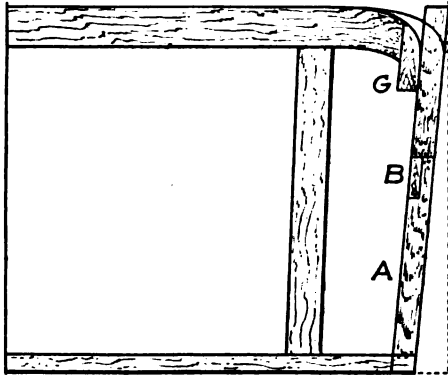

glued on the inside to both pieces and dressed off to thickness afterwards.

By the method illustrated the uncertainty of position and shape of pieces, as in the common method, is overcome, and the frame is accurately gauged. The side piece of seat frame is shaped beveled and applied to the front post AA, after cutting out the lap for the horizontal piece, at BB. The two horizontal pieces C are then cut out to the shape of the draft. These pieces are the thickness of the front post A, which is 1 inch, and are made straight on both outside and inside and dressed to a pattern and cut off at the back end to the line, D. Fasten these pieces at the lap B with screws. make a pattern for the back piece E, using the shape as laid down on plan view of the draft up to the line F which is the inside of piece C. Saw piece E on the inside and outside according to bevel line D, giving a little less bevel as it reaches the corners. To the inner side of corners of piece E glue a block G, so that it will make a parallel line with line F, and when dry cut piece E to line F and fit nicely between pieces C, holding same with thumb screws over block G. To locate E on horizontal pieces C hold a straight edge across the back points of C at line D until piece E meets the straight line. Do the same for the height, marking with pencil to locate in same position, then take off and glue together.

When the glue is dry continue the curve line across pieces C, C, following from the back of line E and you have a frame that is the same shape on both sides and is also an exact reproduction of the draft. The block G will be all or nearly all dressed off, this only serves the purpose of strengthening the cross grain wood until it is glued to the piece C, C. Two strainer uprights in the back will be sufficient to preserve the height.

AS SEEN THROUGH A GLASS.

A novel motor car accessory, and one that has never before been publicly exhibited is known as an automatic road map and consists of a glass disc under which a printed route revolves. In the center of the disc and directly behind the printed route directions, is a tiny electric light. The disc is attached to the steering post and the motorist can read his directions by night as well as by day.

WOOD SHOP HINTS.

Wood Craft is responsible for the hints here recorded:

Don't stop a piece of work in a sander and expect to have the work come out nice and smooth. It is more than probable that the paper will cut a groove in the wood at whatever place the work stops while over the drums.

Don't pull a cut-off saw through the work so rapidly that the saw has to break off the wood instead of cutting it smoothly. No amount of careful fitting will get a saw to cut cleanly if the feed is more than the number of teeth can take care of. Use the Italian system, the up strokes heavy and the down strokes light.

Don't run a saw for ripping until the set or swage is worn too close and try to make up for the poor condition by muscular

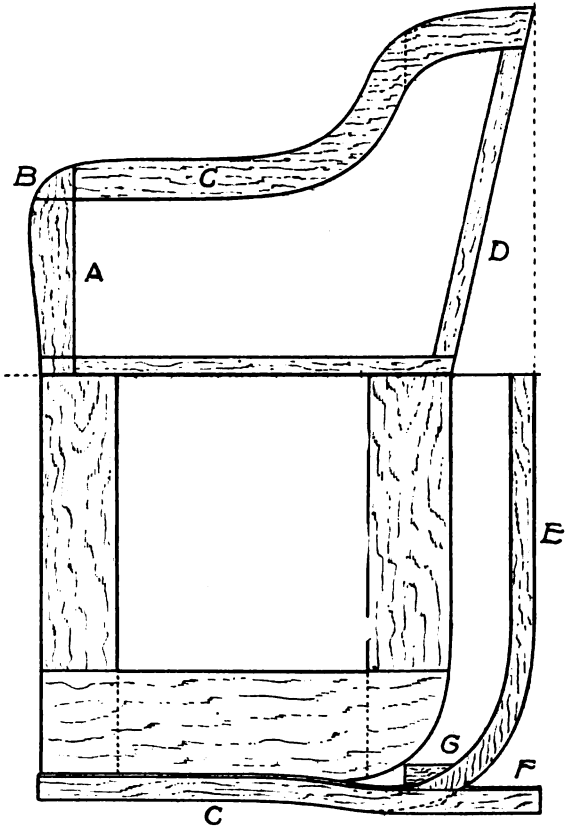

exertion and an assortment of cuss-words. Neither will help matters very much when a saw is out of shape.

Don't pour oil all over the top and sides of a box and a little dribble of it in a small hole for the journal and expect the box to keep cool by the process of absorption from the oil on the outside. If the maker of the machine has made only a small hole in the cap as an evidence of good faith, so that it may be seen that there is a journal there, have originality enough to take the cap off and put something there that will hold oil enough to let the journal realize that the refresher has come its way.

Don't think that because a shop is small the boiler and engine can be run in just any old way as long as there is a shovelful of some kind of fuel in reach. People do that or its equivalent and live to tell the tale while others miss the combination and go to a place that is hotter than this.

Don't allow a box on the line shaft to work loose on the frame or on the pivots. If the box persists in getting loose, better examine the shaft for alignment and get it right. A shaft out of line increases the consumption of power very fast and causes an increase in the wear of all the belts hung to it.

Don't let the ends of stock lap in feeding a resaw unless the stock is of the same thickness. It is likely to make roughened work and does not do a saw any particular good to have a short end rattling against the blade. Not much time is made by this way of sawing.

AUSTRALIAN TIMBER.

The Australian Coach Builder has something to say about the woods the carriage and wagon builders have to resort to that is of interest:

Each State, and sometimes certain districts, have varieties of timber almost unknown in other parts. If the local timbers are at all suitable, they are sure to be used by local industries that require such material. In most cases it is a matter of cost; the price is the ruling power, the suitability of the timber being a secondary consideration.

Wheels, and even complete wagons, made entirely of black-wood, are quite common in Tasmania, and lots of old wheelers have much to say in its favor. One point they never fail to mention is that it is easy to work. In South Australia, she-oak was extensively used for spokes, and would be used to-day if it could be gotten in large quantities. In many parts of Queensland the wheelwrights use whatever timber is cheapest, so long as it is at all suitable, and as they have a great variety of sorts this is not surprising.

But in Western Australia, where they have fewer sorts suitable for our work, and in some parts, perhaps, only one or two varieties, it is surprising what devices they adopt to make the best of local material. In one part the naves and felloes are made from York gum. This may surprise some who know how difficult it is to get a tree large enough to cut planks from which felloes may be cut, as this variety does not grow large in all parts, and is often hollow. In out back places there is no machinery to cut wide planks, all that is available being a spot mill.

The naves are turned and morticed by hand, the spokes are split in the bush, and dressed by hand. The felloes are cut with adze and ax from bent limbs of the York gum tree. The York gum is so dense in the grain, and free from sap, that many have no objections to using it quite green, when it is much easier to work.

CLUB ELECTION.

The annual meeting of the Automobile Club of America was held at the club house in New York city, April 12. The governors nominated this ticket to fill the vacancies named: President, Henry Sanderson; first vice-president, John E. Borne; second vice-president, Robert Lee Morrell; third vice-president, Edward Shearson; treasurer, Finis E. Marshall; governors, to serve four years, from April, 1910, Dave H. Morris, Albert R. Shattuck, E. H. Gary; governor to serve in place of Cornelius Vanderbilt, resigned, until April, 1912, Alfred Ely; governor, to serve in place of Horace Porter, resigned, until April 1913, George Moore Smith.

BOROUGH & BLOOD CARRIAGE CO. SALESMAN ASSAILS AUTO AS MORTGAGE BREEDER.

In the June number of the Technical World Magazine, Rube Borough, traveling salesman for the Borough & Blood Buggy Company, makes a spirited attack upon the motor car through the medium of an article entitled "The Economic Significance of the Automobile." Mr. Borough declares that the motor car has been a mortgage breeder among American middle class buyers—that if the average citizen continues to be swept by the auto craze in the future as in the past, there must result either a curtailment of the necessities and conveniences of modern life or a depletion of middle class holdings.

Mr. Borough declares that his Technical World article is not to be interpreted as a message of despair over the condition of those carriage manufacturers still in the field. He says his company will in the present year do the biggest volume of business in its history. The writer is the oldest son of J. M. Borough, general manager of the company.

OFFICIAL ANNOUNCEMENT OF CONVENTION.

Carriage Builders' National Association
Office of the Secretary and Treasurer.

To the Members of the Carriage Builders' National Association:

The thirty-eighth annual convention of the Carriage Builders' National Association will be held in Cincinnati, Ohio, during the week commencing September 25, 1910.

The exhibition from September 26 to 30 inclusive; the convention September 27, 28 and 29.

We will have fine accommodations both for the convention and the exhibition in the armory of the Ohio National Guard, 1417-1431 Freeman avenue, so these important affairs will be in the same building.

We expect a very large and fine exhibition and some excellent meetings of great interest and value to all our members, and hope they all will arrange to be present.

By order of the executive committee:

HENRY C. McLEAR, Secretary.

PHILADELPHIA VEHICLE BUILDERS MEET.

At a meeting of the Philadelphia Carriage and Wagon Builders' Association the following were chosen for terms of one year: President, Charles W. Preisendanz; first vice-president, William B. Morgey; second vice-president, Thomas Quirk; third vice-president, J. Howard Wilson; secretary, Henry F. Keachline; treasurer, Frank Schanz; executive committee, Charles J. Rogers, Emil Insinger, William F. Powell.

Walter L. Taylor, of the Keystone Spring Works, addressed the members of the association on the subject of springs.

The fifteenth annual banquet of the Association was eaten in Mayer's Drawing Rooms, on March 22. Ex-President Marbaker occupied the place of presiding officer, Treasurer Frank Schanz toastmaster.

Between the courses Miss Marion E. Kloetz sang, and William Gerhab, Jr., recited, also J. B. MacPherson.

Mr. Marbaker, called upon for a speech, said that "the wagon builders have no cause for discouragement, for while the motor trucks have made some inroads into their business, it is by no means to the extent indicated by newspaper talk. All wagon builders should do as much as they are able to do in motor car work, as this is in line with their own trade. If the wagon builder fails to see his opportunity, others will see it and take advantage of it. The wagon builder is only coming into his own in making motor vehicles, or in partly making them."

The dinner was as fine as is customary in a city where they know how to live well and act on the knowledge.

ANNUAL EXHIBITION OF TECHNICAL SCHOOL

The annual exhibition of work done by students in the Mechanics Institute at 20 West 44th street, New York City, was held on the afternoon and evening of April 18. Classes in architectural, mechanical and free-hand drawing, as well as clay modeling, mathematics and physics, are taught, but readers of The Hub will be more interested in the Technical School for Carriage Draftsmen and Mechanics.

The students' work showed much study and careful execution, especially the original designs, several of which were automobile bodies drawn to full size and well worked out, every detail being clearly marked.

The school had a larger enrollment than ever before, and, at the present location there is room for almost unlimited growth, with splendid light for both day and evening work.

GOOD MOVE.

The Jackson (Mich.) Automobile Co. intends establishing a sick and accident fund for benefit of its workmen. The plan will be of the assessment variety, costing each contributor a small weekly sum.

Carriage and Automobile Painting

ACTION OF DRYERS.

An injudicious painter can ruin more paint with bad dryers or with too much good dryer, than all the barytes in all the world has ever injured. Just in this one particular the prepared paint manufacturer has a decided advantage over the painter who mixes his own paints. The manufacturer knows what his dryer is made of and just how much of it each particular combination requires, while the painter must either guess or experiment.

It is believed that the action of certain metals which hasten the absorption of oxygen by linseed oil, is a so-called catalytic effect—that is, their mere presence facilitates a chemical change which in their absence proceeds more slowly.

The facts of catalytic action are well understood, but the causes are obscure. This much is now pretty generally accepted: 1. That lead and manganese are the only two available dryers. 2. That the intensity of the action is proportional to the percentages of these two metals actually present; and 3, that an excess of dryer, beyond certain moderate limits, will retard drying by chemically disintegrating the oil. The last point may be regarded as not yet clearly determined. Now it follows from this that when the painter buys liquid dryer or japan, the only effective portion of his purchase is the incorporated lead and manganese—the rest may or may not be useful in the paint, but it is certainly not “dryer.”

It would seem to an inexperienced outsider that benzine added to paint in the form of so-called liquid dryer is no better and certainly no cheaper than benzine out of the simple unadorned benzine can, and that rosin added to paint under some fancy name, as “japan dryer,” is no more beneficial to the constitution of the paint than if it were added under the less pretentious title of “gloss oil.”

TESTING OIL GROUND PAINTS.

The procedure for testing pigments ground in oil is first to remove the thinners. This is commonly done by shaking up a few ounces of the paint in a large bottle with plenty of benzine. The bottle is then corked and allowed to stand until the pigment has all settled out. The benzine is then carefully poured off and fresh benzine added, shaking as before. After settling, the benzine is again decanted and a fresh supply added, repeating the entire process. After three or four washings in this way, the pigment, now freed from thinners, is removed from the bottle and allowed to dry.

If the pigment was supposed to be straight white lead, a little of it may be placed in a test tube with acetic acid. The lead, if it is the hydro carbonate, will be completely dissolved, with effervescence, while the zinc oxide will also dissolve, but without effervescence. If any undissolved pigment is left in the tube, it may be lead sulphate or one or more of the reinforcing pigments.

Pour off the acetic acid into another test tube and add ammonium sulphide. The lead and the zinc present will immediately precipitate as sulphides, the black color of the lead salt completely obscuring the white of the zinc salt. Calcium carbonate, if present, will remain in the filtrate from this precipitate. It is identified by adding ammonia to neutralize, then ammonium oxalate. Calcium oxalate separates out of the solution in characteristic needle-like crystals.

To identify the zinc oxide add ammonia to a portion of the original pigment. This will dissolve out the zinc. Allow the undissolved portion to settle and then decant the clear solution

into another tube. On adding ammonium sulphide, zinc sulphide will be thrown down as a white precipitate.

Zinc in this form is one of the constituents of lithopone. These reactions show why lead darkens and zinc remains white when exposed to sulphuretted hydrogen gas.

The undissolved portion remaining after treatment with ammonia may contain besides the basic carbonate of lead, lead sulphate and the inert pigments. To remove the lead sulphate for purposes of identification, treat this residue with hot ammonium acetate. The lead sulphate will be dissolved.

To facilitate our work, and as we have been hitherto filtering to save time, instead of decanting, we shall now filter and add our hot ammonium acetate solution to the residue on the filter, then punch a hole in the filter, letting its contents through, then boil and filter again.

We now add a solution of washing soda to the filtrate until there is no more bubbling of carbonic acid in the tube, when the addition of a little more precipitates the lead as the white carbonate.

The residue, after extracting the zinc, the lead, etc., with acid may be barium sulphate, calcium sulphate, silica, magnesium silicate, etc. A microscope will enable one to identify them, but for our present purposes it is not necessary either to separate or determine them.

But the value of a paint coating depends quite as much on its physical properties as on its chemical constitution, and in learning that a paint is or is not lead-hydrocarbonate, unless you have bought it for that, it is hard to see how you are much farther advanced in useful knowledge. What concerns you is how far will it spread? How much will it cost per square covered? How will it look, and how will it wear?

These essential questions you can answer far better than a chemist if you will take the trouble to answer them by actual test, free from prejudice.

CAUSE OF BLISTERING.

There are two main causes, and numerous subordinate causes, responsible for surface blisters. Moisture in the wood is probably as prolific a cause as any. This cause, of course, may be long in making its presence felt. It is merely waiting some unusual event or opportunity to manifest itself. And it may be aroused into action under the hot breath of the sun as soon as the carriage ventures into service. Such blisters, if punctured with the point of a needle may be pressed into position, and do no great damage to the surface not too prominently exposed. Where this treatment fails to prove effective the surface must be let dry out hard enough to flat down, after which touching up, puttying, and surfacing down with rubbing brick will be necessary, with needed colour and some varnish to follow, finally coating the surface throughout. Soft undercoats, fatty, gummy, non-drying, excepting to the point of deceiving the painter, develop blisters when the surface becomes subject to sufficient heat. All coats which do not dry thoroughly are likely, when exposed to right conditions, to ruffle up and stand forth stubbornly. An oily or greasy patch besetting the surface is the forerunner of a surface blister if enough heat concentrates upon the spot to generate action.

An elastic varnish supply and alive with oil, is more apt to blister when some germ lies concealed along the course of its foundation than a hard drying varnish holding in leash the same germ.

Occasionally it happens that a surface explodes into bubbles through sheer heat of the sun, the power of this force being

alone sufficient to lift up patches of surface. To forestall accidents of this sort merely give the surface a sponge bath of clean cold water, flicking the varnish light and using plenty of water. Repeat this treatment for two or three successive days, housing the carriage in shady quarters having the advantage of complete ventilation. As a matter of fact, this treatment is recommended for all finished surfaces to be put into immediate service after completion during the hot periods of the year. It enriches the lustre of the varnish, hardens its outer film, and strengthens it to meet the often harsh exactions of service.

OIL AND TURPENTINE.

There are two important painting materials—linseed oil and turpentine. When you buy turpentine you ought to get the essence of the sap of the living long-leaf pine tree. It will, perhaps, not be with us long as a commercial product, but while it is with us we ought to be able to identify it by a birthmark.

One of the simplest and surest of the chemical tests is the acid test. Place in a long graduated tube a little of the turpentine to be tested. Add slowly and cautiously, a little at a time, about an ounce of strong sulphuric acid. Mix the acid and the turpentine thoroughly together; then allow the tube to stand for half an hour. If there is an adulterant in the turpentine, it will float on top of the mixture and its proportion to the quantity of turpentine originally used can be read off on the graduations.

A still simpler test for shop use is that employed by the German customs authorities. It consists in mixing together equal quantities of the turpentine to be tested and aniline oils. If the turpentine be pure the two liquids will mix perfectly; if impure they will separate in two layers.

The simpler tests for linseed oil are based on its chemical properties but these tests are so thoroughly and clearly explained in a paper by Dr. Otto Eisenschiml, chemist for the American Linseed Co., that every painter ought to have a copy of this little booklet, and make use of it.

REPAINTING AND VARNISHING MOTORS.

Hiram Halsey has met some of the new kinds of paint shop troubles that have come to the surface since automobile bodies have had to be taken in hand as a repair job. In *Motor Print* he goes into the subject in extenso, and some of his observations will fit into the experiences of those who have had to solve like problems.

Touching up a buggy and touching up a motor car are two very different things, and the experienced painter who attempts to revamp a shabby-looking car often finds himself plunged in a well-nigh hopeless task. The economy brought about by the poor results obtained in others when the same process is applied. And the question of choice is far more complicated than in the case of the horse-drawn vehicle.

To a greater extent than the horse-drawn carriage, the automobile invests the work of the painter with difficulties of a not infrequently perplexing nature. Taking motor cars as they come, the surfaces are in a worse condition than the first named class, because, without question, a much harder form of service is imposed upon the automobile. The wrenchings and twistings, oscillation, and lateral motion, etc., despite authorities to the contrary, work injury to the surface, although such injury may not always make itself apparent until the outer film of varnish is stripped off to some extent under the erosive effects of the rubbing pad. Moreover, the general conditions of service are of a kind to put the surface into a more or less disabled state, the varnish being badly worn in some cases, having reached possibly the incipient stage of perishing, or the color showing a faded appearance, or a lack of uniformity in the wear generally.

Probably the worst conditioned surface, as it comes to the carriage painter's shop for repairs, is the enameled one. It is claimed that this latter finish, in the main, is harder and strong-

er, and better fortified to withstand hard usage than the regulation paint and varnish, and to a certain extent this may be true, but the enameled surface after losing the primal brilliancy of its finish, and touched off with some hefty bruises, takes on a shabby look than the paint and varnish finish is scarcely ever capable of showing.

Then, too, the surface of metal, aluminum, or steel, or iron, contributes a further share of difficulty to the touch up and varnish proposition. Many of these surfaces, around moldings and edges, show a scaly condition due to numerous causes, and in such cases the fragmentary structure of paint should be scraped away until a solid base is reached. Then touching the diseased parts with a pigment containing at least one part of oil to four of turpentine should follow. After a lapse of 48 hours these fractures and indentations may be puttied up with a good, hard-drying putty, which in due time can be evenly faced down with a block of rubbing stone dipped in raw linseed oil. Naturally, if such surface conditions exist to any considerable extent, the only permanent way of treating them is to either burn the paint from the surface entirely, or coat the old structure of pigment solidly under, say, three coats of rough stuff. They are not easily concealed by simply touching up and varnishing, although many of them are handled in this way, after facing up with putty as above advised, except in cases where glazing colors have been employed.

Generally speaking the line should be drawn on all jobs stopped for touch up and varnish which show any considerable extent of wear, because in a majority of instances of this kind the touching with color only serves to intensify the effect existing between the old and the new, and following the application of varnish, this effect is likely to increase rather than diminish.

It has always been a question with the painter of carriages, either horsedrawn or horseless, as to what should constitute the precise dividing between the touch-up and the varnish job, and the one demanding more thorough treatment; and the common understanding seems to have been reached that decision in the matter rests with the individual painter rather than with any hard and fast rule promulgated by a committee of experts.

In all touching up and varnishing work, the surface should, after cleaning, be nicely flatted out by rubbing with water and No. 00 pumice stone flour. Then touch with color to the least possible extent, using the pigment thin enough to avoid an abrupt edge which under the varnish shows rough and patchy. Flow on a fine, heavy coat of finishing varnish, which, upon the automobile as upon no other vehicle, plays the chief part in making the prairie like surface a "thing of beauty."

JOB PAINTING.

An exchange says a correspondent has a quick method of painting a repair job, at which a "good man can do three buggies in two days." This is the way it is explained:

Get your customer to bring his buggy to you when it is dry, even if there is mud on it, as it will take quick paint much better than if it was but recently washed.

To begin with, always unhang the job as it is much handier to get at. Rub the mud and dust off of the gear with an old bag; clean the grease off the spindles and hubs with kerosene oil. Then sandpaper the gear with No. 2 sandpaper and with some quick lead, i.e., lead mixed with a little "jap" and thinned with "turps"—no oil in it. Go over the rims lightly, also touch up any spots where wood is bare and also go over any rusty spots or ironwork. Next take body and clean mud off of body bottom inside and out. Sandpaper lightly with fine sandpaper, carefully, so as not to scratch it deeply. Slush over bottom with old skin paint, blackened with lampblack; also slush the bottom boards on inside of body with quick varnish slush, which should be dense black.

After carefully dusting the body color it all over with good quality coach black, without adding any varnish or oil to it, but

thinning with "turps" only—a good even coat. The body will then be ready when dry. Now go back to your gear and glaze the ribs with thin putty, on the outside flat side of them only. Put this on smoothly and rub with the flat of your hand to polish it smooth. It is important to have this putty coat smooth. put on very little, only enough to fill the cracks and checks.

Then dust off and color the gear the same as you have done to body. Use no oil on the gear or you will spoil the job as remember you are trying to paint the job in one day.

After gear and shafts are colored you can clean the top, color the steel bows and joints, etc.; then give the leather a coat of top dressing if top is old or rub over with oil to polish it. Next clean dash and shaft leathers.

You can now go back to the gear and put on a stripe to suit.

Use quick color for your striping. This should have used up all your morning and perhaps more. After dinner set up the body and gear and varnish it.

The only proper varnish to use is a one-coat coach and gear varnish and must be heavy bodied and a quick dryer, one that will dry up before the old dry wood and paint absorbs it. While this job, of course, cannot be gotten very clean, still most of the liverymen are in favor of it, many of the customers having their livery buggies done this way and some of them have it done twice in a season.

There are a few fine reds which will color over a red gear nicely with one coat where the gear has time to stand over night before varnishing.

SHADING.

In sign writing the coach painter should always aim to get as much sharpness in outline and contrast in color as possible, says our Australian contemporary. This is particularly the case in shading. Good or bad shading may either increase or decrease the effectiveness of lettering.

All shading of lettering may be roughly divided into two kinds. One kind is called a "free" shade and the other a "close" shade. The first named is used to denote a shade which leaves a space between shade and letter. A "close" shade is when the shade is taken right up to the letter's edge. Both are right in their place. The "free" shade should be used when the color or tone of shade and letter resemble one another. Leaving a narrow line of the background showing between them helps to keep the outlines of lettering distinct. When the color of shade is in strong contrast to the letter, a close shade may be used. A close shade is generally best for gold or silver lettering. It cleans up outlines, and usually helps contrast.

PAINTING SILENCERS.

Boiled linseed oil 1-5 pound; Japan varnish 1-5 pound; spirits turpentine, 2-5 pound; lampblack 1½ ounces; pure powdered graphite, 1½ ounces; powdered oxide of manganese, ¾ ounce. First mix the linseed oil and the japan varnish well together, then add in the order named, and stirring all the time, the lampblack, graphite and powdered manganese. The solids should be added slowly while the stirring is briskly maintained. As the mixture thickens, thin it down with the turpentine, until the quantity mentioned is added. This paint should be used at once, for it dries rapidly, and every time the brush is dipped the mixture should be carefully stirred. It is well to paint the silencers while they are hot, first cleaning them thoroughly.

RED AND WHITE LEAD.

The use of red lead for wheels and under parts is a long established custom. The actual reason why the red lead has retained its popularity is because it is the most solid, best wearing and greatest damp resisting pigment in use. The material that comes next is white lead. Red lead is said to be the best material for coating ironwork. It is also the best primer or first coat for any class of new woodwork exposed to weather conditions. It hardens like iron. Another thing in its favor is the fact that it is of itself a drier.

RUBBER—THE CAUSE, THE CRAZE, THE EFFECT.

The very large and seemingly unsatisfied demand for rubber has caused the regions of the earth to be searched, planted, exploited for rubber and yet more rubber. The supply being so inadequate to meet demand, prices have soared like an aeroplane, and on the heels of the commercial needs has come the speculative craze, likely to have a spectacular and disastrous climax as soon as the high impetus given to production begins to be felt by a plethora of supplies.

Everyone has heard of this excitement in rubber. The story of the Sultan of Johore selling his crop at \$2 a pound, a tree yielding two pounds, an acre supporting 160 trees, and the lucky man owning thousands of acres, fires the imagination like the '49 gold fever, or George Law's Bubble.

The money interest of the trade in rubber as an article that has to be used, might well be supplemented by some knowledge of where all this rubber comes from, where it is sent for redistribution, what it looks like, and the varying prices for the crude as well as its trade nomenclature. This is all interestingly told in a trade report, and we here reproduce it:

Rubber reaches the London market in almost every possible shape and color. In most cases the queer names in the market reports are mostly descriptive. Thin, pale crepe, for instance, arrives in long strips, generally about 4 feet long and 8 to 12 inches wide. It varies in thickness from one-sixteenth to one-half an inch and has roughish surface, from which the name crepe is derived. This rubber is pale yellow in color, and when held up to the light is quite transparent, which proves its purity and accounts for the very high price obtainable therefor, which in the middle of March was about \$2.48 per pound. The so-called sheet rubber is similar to crepe, but slightly thicker and not so transparent. It is prepared in a different manner, and, unlike crepe, must be put through the washing mills before it can be used.

Hard fine Para is prepared by native labor of the Amazon by dipping a so-called paddle in the rubber and then holding it in the smoke of a fire, which hardens the coating of milk. The paddle is then dipped again for a second coating and again smoked, and so on until quite a large biscuit, generally weighing about 60 pounds, has been built up. The operator, with a knife, then slits the biscuit down one side in order to remove it from the paddle. Rubber so prepared contains a large proportion of moisture, but is stronger than any of the plantation rubber, and sells (March 16) for about \$2.43 per pound.

From the Kongo (Africa) come large supplies of clean, black rubber, coagulated originally in large blocks, and then cut up into small cubes to permit it to dry and ripen. Kongo also ships rubber in reddish sausages collected directly from the tree, the reddish appearance being caused by small portions of the bark adhering. The value of this Kongo rubber is from \$1.34 to \$1.64 per pound.

The Gold Coast ships rubber prepared by the natives digging a trough in the earth and running the latex thereinto. In time the mass in the trough coagulates from the outside, forms a hard skin, and finally gets hard throughout. But this kind of rubber holds the moisture which was originally in the latex, and therefore such lumps often contain 50 per cent of water. This Gold Coast lump is worth about 73 cents per pound. On the Ivory Coast, the French Sudan, and in the Sierra Leone neighborhood, the natives collect rubber from the same trees, but give a great deal more pains to the preparation. The resulting product is known as "Sierra Leone Niggers" or "Konakry." This rubber is in large balls, consisting of strips carefully wound together, varying in size from an orange to a man's head. The rolling process is done while the strips are fresh and they become one compact ball. Rubber treated thus is of a reddish color, for which reason the balls are known as "red niggers," and sell approximately for \$1.46 per pound. These descriptions might be multiplied indefinitely, but those given are sufficient to show in how many various shapes raw rubber

arrives in the London market and what wide experience is necessary to judge successfully the values of the different kinds. It seems singular that values do not move up together on the different varieties. For example, the price of hard fine Para may be going up, owing to the demand, and the price of red niggers going down, and vice versa. Each grade has a market of its own, according to demand. At the auctions on March 14 pale crepe was bringing as much as \$2.49, while hard fine Para sold at \$2.39, while two weeks previously these two values were practically reversed.

Accurate statistics of the sources of supply of crude rubber are almost impossible to obtain, as the figures available are necessarily mostly estimated. These figures, however, have a relative value for the manufacturer of rubber goods. The following is the approximate supply, in tons: Amazon River with its tributaries, 39,000 tons; other districts of Brazil, 2,800; Federated Malay States, Ceylon, and Sumatra, 4,600; Belgian Kongo and French Kongo, 5,600; Portugese West Africa, 2,900; West Coast of Africa, 9,500; Rangoon, Penang, Borneo, etc., 1,200; East Coast of Africa, Mozambique, and Madagascar, 800; Mexico, East Indies, and Central America, 1,500; total, 67,900.

A general idea of the uses to which the different grades of rubber are put may be interesting. As a rule, it might be laid down that rubber which can be used in high-class work, such as motor tires, elastic thread, surgical goods, etc., can be also used for inferior grades of manufacture. The manufacturers vary their mixtures according to the price of the different grades, their efforts being to produce the cheapest possible mixture consistent with the selling standard of the product. It is true that high class rubber can be used for almost anything, but the inferior grades can be used only for inferior articles, such as garden hose, door mats, rubber flooring, etc., where elasticity is not essential.

The product of the Amazon is approximately divided into three grades: Fine Para, about 24,000 tons; niggerheads of various descriptions, about 8,000 tons; and Peruvian ball, about 8,000 tons.

Fine Para is the standard grade for motor tires for the entire market. It is bought and sold on name only, without samples being shown, and is the one grade which, generally speaking, can be used for the manufacture of all rubber goods. The present price is about \$2.43 per pound, and manufacturers therefore economize as much as possible in its use, particularly as in the crude state it contains about 15 per cent of impurities, mostly water, so that by the time the manufacturer has washed and dried it he has a raw material that costs him \$2.92 per pound. But for really high class goods, such as the inner tubes of motor tires, the manufacturer has no alternative but to use hard, fine Para. No other rubber has the necessary strength to stand the strain. For the outer cover manufacturers are able to use with fine Para a certain proportion of other rubbers, niggerheads and ball, or fine plantation rubber and some of the medium grades. It is estimated that the present annual consumption of rubber for motor tires alone is not less than 30,000 tons. It is therefore evident that, without considering the cost of this high grade rubber, the quantity of fine Para required for motor tires could not be maintained.

Another very important item of consumption for which nothing but hard-cure fine Para can be used is the so-called india rubber thread, used in the weaving of all sorts of elastic fabrics. The consumption of these articles shows no sign of decrease but rather a steady increase, in spite of the enormous rise in the price of crude rubber. It must be remembered, however, that while the price of rubber has advanced, the costs of production, such as labor, power, canvas, and other expenses that go in the make-up of rubber goods, have not advanced.

The fair average yield of rubber, per tree and per acre of 120 trees, at the several ages of the trees, are given as follows:

| Age of trees. | Pounds Yield per tree. | Pounds Per acre |
|------------------|---------------------------|--------------------|
| Four years | ¾ | 90 |
| Five years | 1 | 120 |

| | | |
|-------------------|----|-----|
| Six years | 2 | 240 |
| Seven years | 3 | 360 |
| Eight years | 4½ | 540 |
| Nine years | 6 | 720 |
| Ten years | 7 | 840 |

The foregoing estimates are for estates on good average soil, under competent European management, where all that is possible is done to work for safe, immediate, and assured future results. The number of trees to the acre is fixed at 120, because where the number is greater the yield per tree will be proportionately less. The average cost of producing rubber ought to be put at about 30 cents per pound.

There has been a remarkable growth of rubber production in the Malay Peninsula during the past five years, as compared with that of Ceylon and India. The following shows approximately the areas planted with Para rubber during the past three years in the Far East:

| Years | Dutch E. India and | | | |
|------------|--------------------|-------------------|-------------------|------------------|
| | Malaya. Acres. | Ceylon. Acres. | Indies. Acres. | Burma. Acres. |
| 1907 | 100,000 | 150,000 | 70,000 | |
| 1908 | 185,000 | 180,000 | 90,000 | 30,000 |
| 1909 | 240,000 | 187,000 | 120,000 | 31,000 |

In January, 1909, good sheet rubber realized \$1.24 per pound, pale crepe, \$1.33 per pound. In May the prices commenced rising, until November when pale crepe reached the highest of the year, \$2.35. The high prices obtained from July to November, 1909, arose from the rapid increase in construction of motor cars and taxicabs, especially in the United States, where enormous contracts for tires of all kinds resulted in a greatly increased consumption. Smoked rubber is superior in its resilient strength and all fine rubber from Para is smoked as it seems more suitable for many purposes than the unsmoked product. The protein in rubber is preserved from decomposition much better after passing through the smoking process and consequently the product brings a higher price, often as much as 12 cents a pound above the unsmoked kind. The world's supply of rubber in 1909 was about 70,000 tons, this being an increase of 5,000 tons over 1908.

AMESBURY LOOKING TO SIBERIA.

T. W. Lane, carriage manufacturer, recently shipped a carriage on a journey to Siberia. Mr. Lane is one of the few of Amesbury's manufacturers who holds exclusively to the making of carriages.

Never in the history of the town have the prospects of the carriage or auto body makers looked so bright as they do now. Most of the makers have enough work ahead to last them until Christmas and some have enough orders to run them a year. This is particularly so of the builders that have already got their contracts for the 1911 bodies. While at the present time it is a little quiet in some shops, owing to some slight changes in specifications, most of the factories are booming. That prospects are pretty good here is shown by one Boston firm sending a representative offering thirty dollars a week for trimmers and he couldn't hire any at that.

AND THIS IN BUSY SOUTH BEND.

Extensive plans for the regulation of traffic in the business district to eliminate the crowded conditions of the streets were discussed at a meeting of the board of public safety. A plan was devised to relieve the rush hour crowd and the patrolmen will enforce the rule.

The plan outlined by the board consisted principally of a strict enforcement of the keep-to-the-right rule. This order will even be carried out in a crossing of the street, persons driving vehicles being enforced to keep constantly to the curb on the right side of the street.

Practical Development of the Commercial Motor

What Appears to be a Solution of a Hard Problem

THE efforts to make the motor vehicle adaptable to commercial use have met with obstacles almost insuperable from both a technical and expense point of view. The problem is so different from the studied care given to a pleasure vehicle, and the rough and uninformed usage the commercial truck receives at the hands of carelessness and limited technical intelligence.

It is something serious to face the expenditure of three or four thousand dollars for a piece of highly organized and delicate machinery that is put to rough and continuous work, that so far has promptly put the vehicles out of commission or run up repair bills that have caused the proposition to be a not attractive one, commercially considered.

The description of the Couple-Gear platform truck which follows seems to resolve the hard conditions into easy ones. The starting and stopping of a truck equipped in the usual way is the cause of most of the trouble with the strictly gas-engine cars and transmission. This is one difficulty cancelled by the construction herein described. In practical use it has met all questions and given a fair and convincing answer. Its economy on the utilization of the plant already in service is not the least of its salient features.

Speaking technically it is a recognized fact among automobile engineers that the mechanical transmission of power to the rear wheels of a motor-driven vehicle and the mechanical speed change gearing in common use involve serious losses of power which increase with every link in the transmission chain. Nevertheless it has for a long time been the best available means, and by dint of careful designing and construction and the use of the highest class of materials, has been made to answer very well in pleasure car work and in the lighter types of commercial vehicles. For heavy work something better has been needed, and the Couple-Gear Freight Wheel Co., of Grand Rapids, Mich., believe that they have solved the problem by their method of applying power direct to the wheel rims through electric motors. The usual chains, sprockets, differential, counter-shafts and gears of the more familiar type of electric truck are eliminated. The motors are enclosed in the wheels, and the body of the truck is unencumbered except for the battery box.

In the case of the mixed system Couple-Geared truck, or as the company calls it, the gas-electric, there is an entire absence of speed change gear, clutch, counter-shafts, chains, sprockets, differential and live axles, and the controller is, if possible even simpler than that of the battery truck.

The larger trucks drive and steer with all four wheels, and all four wheels are fitted with power brakes. Electric brakes are also provided, there being a controller position in which the motors are grouped as generators feeding through a resistance. The retarding effect is sufficient to hold the truck down to a moderate speed on the most precipitous grade.

One of the advantages of the 4-wheel drive system combined with the efficient transmission principle is that the draw bar pull of the Couple-Gear truck is enormous. A large western concern uses one of these vehicles, fitted with a storage battery, as a switching engine, handling heavily loaded freight cars around sharp grades which locomotives were unable to negotiate with safety. A Couple-Gear truck of the gas-electric type used as a tractor in New York city has hauled a total load of 42 tons with no load on the truck. The weight of the truck was about 11,000 pounds.

The distinctive feature of the Couple-Gear truck is embodied in the electric motors and the drive from motors to wheels. Instead of following the usual practice of hanging one or two motors from the chassis and transmitting the power from them to the wheels by means of chains, sprockets and gears, the motors of the Couple-Gear truck are attached direct to the outer ends of the stationary axles, the wheels are built around them,

and the power transmitted from the armature shaft to the wheels by gearing, so that the motors are stationary while the wheels revolve around them. This method of construction results in the concentration of the entire driving mechanism at the point where the power is required, and the losses incident to the transmission of power through gears and chains are practically eliminated. The motors are completely enclosed, and are so thoroughly protected that the truck may be run through water up to the hubs without water



Couple-Gear Attached to Wagon Body.

reaching the motors. The weight of the wheels and the motors in them is near the ground and the centre of gravity of the truck as a whole is so low that it is extremely difficult to capsize the vehicle.

From an engineering standpoint the principles involved in the Couple-Gear wheel and motor and the mechanical details involved in putting these principles into practice are interesting. The motor, rated at 3 H.P. and with a momentary overload capacity of 200 per cent, is placed with its armature in a horizontal position and practically at right angles with the axle. It is a four pole motor with two fields, the upper and lower, wound. The armature shaft carries a bevel pinion at each end, and these pinions mesh with larger gear wheels attached to the inner faces of the heavy steel discs which take the place of spokes as well as serving to enclose the motors. These rings are placed at the extreme outer edges of the discs just inside of the rim of the wheel, so that the power is applied as close to the tire as is mechanically possible and closer to the tire than in any other form of construction with which we are familiar. It would be understood that with the armature rotating in a given direction the pinions on the armature shaft would, if meshed at diametrically opposite points on the same gear ring, tend to rotate the ring and the wheel in opposite directions. This, of course, being an impossibility the wheel would be locked; therefore two

gear rings referred to are used. The rings being on opposite sides of the inner surface of the wheel, it is necessary that the armature shaft should be set slightly out of a right angle with the axle in order to permit the pinions to mesh with their respective gears. In the heavy trucks there are nine teeth in the pinions and 225 teeth in the gear rings, giving a single reduction of 25 to 1. This is the only gearing used in the machine.

Those who are posted in mechanical matters will doubtless perceive that with a solid armature shaft, the adjustment and alignment of the bearings, gears and pinions would have to be exceptionally accurate, and that the slightest wear of these parts would result in a rapid increase of friction and wear and consequently in a great loss of power. This is provided for, however, by making the armature shaft in two parts, connected by an equalizer which performs exactly the same function as the differential of an automobile. The two part shaft passes through a sleeve upon which the armature is mounted, and the equalizer is in an enlarged portion of the sleeve at the end opposite to the commutator end and occupying the same relative position as the commutator.

The two brushholders are of special design owing to the small space in which they must be placed. Each carries two carbon brushes of the self-lubricating type.

The bearings in which the armature shaft runs are long and are placed as near the pinions as possible; in fact, the inner ends of the teeth of the pinions just clear the ends of the bearings. This gives ample support to the shaft and prevents any tendency to spring. The bearings are lubricated by automatic wick feeds with oil cellars covered by spring doors which can be opened at any time, and the quantity of oil remaining seen at a glance. One filling of the oil cellars is sufficient for several days' ordinary work. The wick feed supplies sufficient oil to lubricate the bearings efficiently without causing oil to be thrown out so that it can get on the commutator and motor windings. What little oil does work out escapes at the pinion ends of the bearings and falls on the large gear rings, which are thus given the small amount of lubrication they require. A sheet metal shield is placed over the motor so that oil dripping from the gear rings at the top will not get on the motor but will simply drip back to the gear rings again. The small quantity of oil required by the equalizer in the armature shaft is fed from the bearing nearest to it through a hole drilled in the short end of the shaft.

At first sight the manner in which the wheel is carried on its axle is a little puzzling. It will be readily understood, however, that the motor is considered as merely an enlarged part of the stationary axle with bearings for the wheels former at front and rear. The motor frame consists of two main castings. The rear one carries a stub which is tapered and fits into a correspondingly tapered socket in the steering knuckle. That portion of the stub nearest to the casting forms a journal on which the inside roller bearing of the wheel turns. A second similar casting forms the front of the motor and carries a shorter stub which forms a journal for the front roller bearing. The two castings carry arms whose ends form brackets between which the armature bearings are clamped. The arms are provided with lugs for bolts at the points where the bearings are carried and also close to the main castings, and dowel pieces are inserted so that all shearing strain is taken off the bolts. When the castings are bolted together spaces are left at top and bottom where the field magnets are inserted and bolted in place. The castings are of crucible steel of such strength that no breakage in the motor has ever occurred.

The roller bearings upon which the wheels run are carried in hubs hot riveted to the wheel discs. The rollers run on hardened steel races, the entire bearing being of special alloy steel made very hard on the surface with a soft core to prevent breakage. The wheel is held in position on the axle by two large adjusting nuts, one at the front and one at the rear, carrying ball bearing thrust collars. These nuts serve to hold the wheel in such a position that the pinions on the armature shaft mesh equally in their respective gear rings.

The cables through which current is led to the motor pass through the tapered stub at the rear which is made hollow for the purpose. The cables are four in number, one for each field and one for each brush. The four cables terminate in a four-pronged plug which enters a receptacle wired to the controller. The prongs in the plug are so arranged that it can only be inserted in the receptacle in one position so that wrong connections are impossible.

The axle, as already stated, is tapered and enters a tapered hole in the knuckle casting. It is keyed to prevent its turning and is held in the socket by a large nut.

The Couple-Gear trucks are built in two types which differ only in the source of electric current. In one case the current is supplied to the motors in the wheels by a storage battery, and in the other there is a gasoline engine direct connected to a generator or dynamo. This type of truck is used where long runs are to be made and the distance covered is beyond the capacity of storage battery. In the larger trucks the engine is of the vertical four cylinder type developing 45 H.P., and is direct connected to a generator rated at 15 K.W., but capable of carrying an overload of 100 per cent almost continuously and 200 per cent momentarily. The control in the case of the battery truck is through a street railway type controller. In the gas-electric truck there is a controller which is the electrical equivalent of a high and low gear; that is to say, when the controller is in one position the truck will travel at its maximum speed, while in another controller position the truck travels at only half the speed but with double the power. The quantity of current sent to the motors is regulated entirely by governing the speed of the engine, this being done through a foot throttle automatically closed by a spring, so that when the foot is removed the throttle closes to a point where the engine turns over but does not drive the generator fast enough to generate any current. It will be seen that any speed from minimum to maximum may be obtained by merely pushing the throttle, manipulation of the controller being required only when exceptionally severe grades or abnormally bad roads are encountered, or when it is necessary to reverse.

The steering gear is of the worm and sector type, and each pair of wheels has its separate gearing, the two being connected by a shaft when a 4-wheel steer is used.

An interesting fact in connection with the wheel motors and gearing is that the loss of power between the motor and the wheel is very slight, rarely over 2 per cent. The manufacturers guarantee an efficiency of 97½ per cent, and in a recent test made by the United States Government of one of the wheels of a large searchlight equipment used by the army, an efficiency of 97½ per cent was obtained from a wheel that had been in hard service for several months.

The great tractive power of the 4-wheel drive Couple-Gear truck is utilized in a peculiar type of vehicle which has been named a semi-trailer. The semi-trailer consists of a Couple-Gear gas-electric chassis considerably shortened and equipped with a special type of fifth wheel located a little back of the centre. An ordinary wagon body with its front wheels and pulling gear removed is mounted with its fifth wheel resting on the fifth wheel of the chassis. This combination constitutes a six-wheeled vehicle in which half the load is carried on the chassis and the other half on the wagon wheels at the rear. The total load carried may be double the normal capacity of the chassis; that is to say, a 3½ ton chassis is used to make up a 7 ton or 8 ton semi-trailer, while a 5 ton chassis is fitted with a semi-trailer body carrying from ten to twelve tons, and such is the efficiency of the power plant that these loads are handled with ease in daily service, notwithstanding steep grades, heavy snows and other obstacles to power haulage. A patent has been applied for.

A very important advantage of the semi-trailer arrangement is that the proportion of the load carried by the rubber tires can be so calculated as to be within the capacity of rubber. The tire question has always been one of the gravest importance, especially when loads have exceeded five tons, and this semi-trailer arrangement seems to solve the problem without the

use of abnormally large or prohibitively expensive tires. Another advantage of the semi-trailer is that with the 4-wheel steer it is capable of being handled in extremely close quarters. An 8 ton semi-trailer can be handled easily in quarters so close that a 5-ton truck carrying a load of similar character could be handled only with the greatest difficulty. Backing up is accomplished readily after the driver has had a little practice.

The Couple-Gear wheels find another important application in the conversion of existing horse-drawn vehicles into automobiles. It is only necessary to remove the front wheels, install Couple-Gear wheels, axle, steering gear and other controlling apparatus, and hang under the body either a battery or a gasoline engine and generator. There being no mechanical connection to the wheels, the application can be made to vehicles which could be converted in no other way.

SOUND ADVICE WELL APPLIED.

W. Lawton Goodman is the new president of the British Institute of Coach Builders. At the annual banquet his speech contained some ideas as to the attitude of the coach builder to the car builder that are interesting even to those at the long range of three thousand miles. We give space to a few extracts:

Our first engagement was with that of the completed motor car, and this introduced a new competitor—the sole concessionaire. It was he who left the first class foreign motor bodies and introduced that cheap and shoddy article known as the “works body.” I honestly believe these gentlemen should have a vote of thanks passed to them by the coachbuilders of England for the services they have thus rendered in destroying the possibility of the sale of motor bodies in England, and I trust in the enforced seclusion and retirement in which they are now placed, that these few words will prove to them both grateful and comforting.

Our second engagement has been with those of our friends at home, the English chassis maker, to whom in his sphere we wish greater success than to anyone else; but he has usurped, forsooth, the post of coachbuilder, and as an engineer he went into our trade with the idea that motor bodies were produced like sardine chests, designed like flower pots, and upholstered with the comfort of the benches in the park. The discriminating faculty of our old patrons, the carriage users, readily appreciated the creations, and carefully avoided their discomforts, and the stock of these useless weird creations are now to be found in the Midlands—monuments of ignorance, wasted money and labor lost.

The next phase of our engineering friend was to engage all who called themselves coachmakers to secure what he believed to be talent. He has raised the price of labor and the cost of production all round, and this has proved disastrous to everybody. I am inclined to think that the annual wage is no greater, and the disturbance to the workman and their families has no compensating advantage. I emphasize these remarks by mentioning the fact that the most powerful Workmen's Society in the carriage building trade has found it necessary to impose levies upon its members for some considerable time past to make up for the inroads made upon its funds by the number of men out of work. That sufficiently indicates the fact that there is no benefit arising either for the employer or the employed. Here again our engineer has failed. His astute commercial instincts have led him to think that if he obtained the labor all would be well, but he has overlooked the fact that however great the skill, however good the design, he has failed to secure the essential features of high class, durable coachbuilding, namely, seasoned and tried timber. He evidently thought that timber could be employed like bars of iron or steel, pulled out of the rack and used forthwith.

A well known engineer, who really builds a first class chassis and was equally desirous of building a first class body, was once visited by a first class coachmaker, and this engineer was particularly proud of his equipment. He remarked to the first class

coachmaker: “Well, sir, what do you think of my equipment? Is there anything wanting?” The coachmaker was an old North countryman, who understood well the conduct of first class work, so ventured to remark: “Yes, there is only one thing wanting.” “What is it?” “It is a drain to carry off the wet from the saw.” Well, sir, such being the case, these bodies are born in consumption and they finish in decay. Notwithstanding the sway our friends desire to wield in our shows, and the preference shown by our kindred society—that of the Society of Motor Traders—to these gentlemen they have again failed to satisfy the public.

If our friends wish to avail themselves of the help of the British coachbuilder, the sooner they quit making bodies which they do not understand, and which the public will not buy, the better it will be for the shareholders of their company and the buying public. Let the chassis-maker stick to his chassis and leave the body to the coachbuilder. They must understand that we are also manufacturers and not dealers. The coach and motor body trade is ours, for by our work we are known; and I exhort you to make the soundest and most comfortable and excellent carriage, and whether it be a carriage or a motor, the future is assured.

STRIKE IN KANSAS CITY.

Carriage and wagon workers have struck for an increase in wages. Eight shops are said to be affected, including some 130 workers. The trouble, as described by the strikers, is one that goes back about a year.

The advent of foreign manufacturers in the local field first caused differences between the Kansas City manufacturers and their employes. A Quincy, Ill., firm established a branch plant and signed an agreement with the employes. This firm had been successful in breaking up the carriage and wagon workers union in Quincy and it was feared attempts to the same purpose would be made in Kansas City.

The firm has been shipping in certain parts made in non-union shops and assembling them. The product was then put on the market in competition with Kansas City union made products and was claimed to be union made. This the workers opposed and recently drew up and presented to the Master Wagon Builders' Association a new agreement covering the point at issue and asking for an increase in wages averaging 8 per cent. The association was given thirty days to consider the new agreement and was asked to confer with the grievance committee of the employes' union. The builders avoided the meeting and did not offer proposals to the employes. Consequently the union men held a meeting and decided not to report for work.

COST ACCOUNTING PATHFINDER.

This very useful treatise in book form, the substance of which has appeared, serially in *Farm Machinery*, also published by the Midland Publishing Company, St. Louis., publishers of the book, should be in the hands of all who want to know the relation of cause and effect, relation of cost to profit, and direct methods of arriving at business conclusions that are not misleading.

The subject of cost-accounting is one that has to be very carefully explained to most people. They approach it in an attitude of mind that makes its consideration difficult for them. This little treatise ought to be welcomed as one of the best of counsellors and helps.

It has been prepared by Mr. Frank E. Goodwin, an associate editor of *Farm Machinery*, and he is to be justly complimented on a faithful and indiscriminating piece of work. There is no price for the book stated, so we assume it is issued for the benefit of those who subscribe to *Farm Machinery*.

S. J. Fisher, Truro, N. C., will soon have a completed new carriage shop.

OBITUARY

L. J. Haslup, retired carriage builder, of Baltimore, Md., is dead.

James Young, Whitehall, Mich., died at the age of 82. He conducted a wagon shop. A widow and ten children survive.

William P. Cole, Louisville, K. Y., a retired carriage builder, died April 6 from consumption. He was 60, a native of St. Louis and is survived by a widow and two daughters.

Philip Happerberger, founder and for many years president of the Empire Wagon Works, died April 22 of pneumonia and heart failure in Brooklyn, N. Y. He was born in Germany seventy-nine years ago. He left a widow, one son and one daughter.

Jacob Hitorbeck, a well known builder died at his home in Lancaster, Pa., April 18. Death was caused by a stroke of apoplexy. He began as an employe of the Atlick shop, then with Cox, Dexter & Co. He was born in 1834. His wife and three children survive.

Henry C. Ege, secretary and treasurer of the Studebaker Brothers Company of Minneapolis, died April 22, at his home, after an illness of two months, from leucothymia, or excess of white blood corpuscles. Mr. Ege was about 42 years of age, and had been a resident of Minneapolis since June, 1909.

Mr. Ege came to Minneapolis from St. Paul, where he was a member of the Thompson & Ege Buggy Company, and where he had lived sixteen years. He is survived by his wife and one daughter.

John J. Fenton, one of the best known carriage makers in the Connecticut Valley, died April 3 at his home after a week's illness. He was senior member of the firm of Fenton & Dunn. He was born in Maine, but early came to Holyoke, where he lived all his life. He leaves a widow and eight children.

Edward C. Reed, 66, head of the Curtis & Reed Carriage Company, Piqua, O., was killed by an explosion of acetylene gas on March 29.

Warren Stewart, pioneer wagon maker of Plainfield, N. J., died April 4. He was 80 years old. He set up his shop fifty years ago and never moved it from there. He was born within four miles of his shop and never lived farther than that away from the homestead. He never rode on a trolley, nor a steam car, and never saw New York. He went to Newark once, but went by wagon. He was an expert at his trade. He leaves a widow and one son, the latter his partner in business.

Joseph Corblay, aged thirty-four, died in Fairmont, W. Va., March 23. He was one of the proprietors of the Corblay wagon works. He is survived by a widow.

Wandel Pister, a retired wagon builder, died at his home in Baltimore, Md., April 5, aged 65 years.

Frank R. Thrall, aged fifty, one of the founders and for years the manager and principal sockholder in the Muncie (Ind.) Wheel Company, died in Detroit, Mich.

William Greenwald, a widely known manufacturer, died at his residence in Dayton, O., after an illness of six weeks, from blood poisoning. He was 44 years of age. He was president and superintendent of the Zwick-Greenwald Wheel Company. He leaves six children.

Thomas M. McLean, president of the Embree-McLean Carriage Company, of St. Louis, passed away April 9, after an illness of nearly two months. Mr. McLean, with James G. Embree, organized the company in 1889. He always took an active part in the company's affairs and was most enthusiastic over the automobile department recently added, but unfortunately, did not live long enough to see the first cars turned out, which have been completed since he was taken ill.

Mr. McLean was born in Hollidaysburg, Pa., in 1846. At an early age, he went with his parents to Chicago, and later engaged in the wholesale hardware business in that city, until the great fire which destroyed his company's business. Later he

removed to St. Louis to connect himself with the old hardware firm of McCombs, Keller & Byrnes, with which and the successors of it, he remained until the business was sold to the Simmons Hardware Co, in 1889. He married in St. Louis in 1876. Mr. McLean was a popular gentleman, well liked in his business and social relations, and was a member of several prominent clubs.

John Neiner, president of J. Neiner & Co., St. Louis, died April 19. He had been ill for three years. He is survived by a widow and seven children.

John R. Drake, Sr., for fifty years a prominent carriagemaker of Lebanon, Ohio, passed away at the home of his son in Newport, Ky., April 20. He was 77 years of age and is survived by his wife and son. He had previously suffered a stroke of paralysis and this is what brought on the end.

Charles McIntosh, of Milwaukee, died in Naples, Italy, April 19. Mr. McIntosh was a capitalist interested in many concerns, among them the Pierce Motor Company, of Racine. He was born in New York sixty-three years ago.

Frank J. Comerford, one of Chicago's old settlers, died at his residence, 663 Englewood avenue, aged 79 years, death resulting from a week's illness from pneumonia. He was a carriage and wagon maker. He leaves a widow, two sons and two daughters.

MOTORS IN PORTO RICO.

John M. Turner says the demand for automobiles in Porto Rico has been in excess of the supply. Agents report waiting sometimes as long as three or four months for their orders to be filled. There are more than 1,000 kilometers of splendid roads on the island, and an appropriation has just been made by the legislature to extend many uncompleted roads and join ends of these with completed ones, thus extending the mileage.

The incident is cited of a large American manufacturer of automobiles taking a steamer for Porto Rico and upon landing arranging with a local liveryman for a coach to take him around the island. After he had gone a few miles and meeting a half dozen automobiles, he arranged with a garage for a machine to take him on his journey. He said he had no idea there were such roads or such possibilities of trade, and while there he arranged an agency and actually disposed of half a dozen cars for shipment. In all there are close to 300 automobiles on the island. This year will see a marked increase in the number of machines bought, as the island is very prosperous, and there will be large purchases of automobiles when the money is distributed.

The island is hilly. The roads were originally built for military and heavy traffic, with little regard for easy grades. It is not unusual to find 10 per cent grades, and there is one very stiff climb up a 12 per cent grade. Some maker of automobiles could easily capture the trade of these West India islands if a machine were made to fit existing conditions. There is no frost here, the heat is uniform, and at times in the sun a machine will run at a continuous temperature of 125 degrees Fahrenheit. It may be that a larger radiating surface for this climate would be an improvement. The climate is hard on rubber, leather and polished surfaces, so that if improvements can be made in any or all of these strides will be made toward capturing the trade. Varnish does not last. A fine looking automobile will look like a second-hand one after thirty days' use. All exposed iron parts rust in a short time, brass tarnishes quickly, and nickel shows rust streaks after short service. Tops of leather are almost useless for automobiles, the rubber cloth ones do not last any time, and the only kind that seem to wear at all are those made of canvas, treated to make it waterproof. Some varnish or other polishing fluid should be used that would be more permanent. Leather molds quickly and needs constant cleaning. Other material that would not be attractive to moths, such as firm cotton drill, etc., could be used for covering.

The Spoonheim Riddell Co, Northwood N. D., implements and vehicles, has incorporated; capital, \$50,000.

RICHMOND, VA.**Hub Correspondent Makes the Rounds of the Trade and Finds Everybody Busy.**

The carriage trade of Richmond, Va., has been in very good condition and buyers have taken hold more readily than in some other places. The automobile has made some inroads on the trade, but has not hurt it to any great extent. There is considerable retail trade here and for a place of the size there are quite a number of repair shops, wholesale and manufacturing interests. The position of Richmond with the South has been the means of keeping the business up to considerable proportions. Buggies, runabouts, surreys, and cutunders are meeting with a more liberal demand than other lines. Prices have advanced some in all lines and everything is held at firm value. Platform and spring wagons have had an unusually good sale. Dump and ice wagons and other heavy work have had a very fair sale. Hubs, spokes and all lines of carriage hardware have had a very good demand, which seems to be increasing each year. On the whole the trade is not in as bad condition here as possibly in other places. Some of the firms are getting into the automobile business, which is theirs by right and properly belongs in this line.

E. L. Taylor & Co., 1415 E. Main street, wholesale carriage hardware, say that business is very good this year.

W. C. Smith & Co., 314 N. 5th street, reports the carriage repair business as good. Sales for runabouts and surreys very good. This firm has been in business for 70 years. Mr. Smith has built a large garage and is handling the Mitchell motor car, manufacturing automobile tops and general repair work.

Conrad Gross, 310 N. Adams street, is doing considerable automobile and repair work.

The Bristow-Worsham Co., 1417 E. Main street, say the winter was quite dull, but business has now opened up good in the retail and jobbing line, including buggies, runabouts, surreys, cutunders, etc.

The Richmond Engine and Pump Co., 1422 E. Main street, is doing a fine business in handling the Old Hickory wagons made at Louisville, Ky.

The Ainslee Carriage Co., 8 S. Eighth street, went into bankruptcy, also the individuals went into personal bankruptcy, the receiver for the firm being John Lea, of the Merchants Bank Building. The liabilities were \$32,000 and assets \$9,000. Austin Brockenbrough was secretary and treasurer, and was well liked among the trade and a hard worker. He is considered one of the best carriage salesmen in the South. They hope to get together and reorganize as they have about the finest showroom in the city.

A. Meyer's Sons, who have built a large addition to the business, which runs in an ell to 731 E. Cary street, where their office and showroom are. They have taken up auto repair work and have put in machinery to manufacture wagons on a larger scale than before. They have put in a West tire setter and other improved machinery.

The Watt Plow Co., A. C. Sinton, general manager, 1426 E. Main street, say that business has now opened up well. The surrey, platform and spring wagon demand is very good, buggies are improving and business is better than for the same time last year. Have opened new repository and offices at 1436 E. Franklin street, and warehouse at 122 S. Fifteenth street, which is 267 feet long, 3 stories in height, and have spent \$2,000 on improvements. Will eventually give up the Main street store and concentrate their whole business on E. Franklin street.

T. H. Morris, of 5 N. Eighteenth street, had an accident, broke his collarbone and has been laid up some time, but is now getting around to business. Has enlarged the plant, put the painting and trimming shop on the second floor and made other improvements.

R. H. Boshers Sons, 15 S. Ninth street, were established in 1814, deal in and are manufacturers of high class vehicles, cater to the finest trade here, do a fancy wagon business, and also

make carriages. and do auto repair work, They expect to put in a line of automobiles.

J. A. Grasberger, 20 N. Twentieth street, is looking for a good business this year. He has started doing auto repair work and is handling the Schacht runabout automobile. His trade is largely ice wagon business of which he makes a specialty.

George C. White & Son, of 406 No. Fifth street, do quite a large business in manufacturing and repairing of carriages and wagons, have built a large addition to the plant, making it a three story building 25x150 feet in size. They are preparing to go into making auto body work and may put in a line of automobiles.

Baldwin & Brown, 1557 E. Main street, wholesale carriage and hardware, report business as normal, up to the average of former years.

Hening & Nuckols, 1436 E. Main street, say the farmers are all busy now and a good trade is being done in farm and dump wagons.

Hoenniger-Sizemore Co., 1433 E. Main street, have more business than they can do, and sell largely through Virginia and North Carolina, are jobbers and not manufacturers. The top buggy is selling the best, wagons are a little quiet. This firm is successor to F. C. Hoenniger & Bro., and the Richmond Buggy and Wagon Co. F. C. Hoenniger is president; T. W. Hoenniger, vice-president, and W. L. Sizemore, secretary and treasurer. They handle the Barbour carriages, Virginia wagons and farmer's surreys.

E. C. Bristowo, 11 S. Eighteenth street, is busy on repair work, painting and rubber tire business.

Arthur Ryan is superintendent of the Virginia and North Carolina Wheel Co., whose works are at the Osborne Turnpike, and are doing a very satisfactory business.

NORFOLK, VA.

Norfolk, Va., is a very busy, wide-awake place, and does a considerable repair and retail business. The good grade of carriages sell well and the medium grade have an excellent demand. The top buggy, runabout and surrey seem to be playing favorites with the public. The trucking business is very large and helps the carriage and wagon trade a great deal, as it is carried on in proportions here that is wonderful.

W. T. Godfrey & Co., 60 Union street, do general repair work and make some wagons.

J. W. Borum & Son Co., 351 Church street, sells most of its carriages and wagons out of town and makes delivery and farm wagons to order.

C. E. Wright & Co., 200 Monticello avenue, say that the prospects are splendid for an extra good year's business. They also manufacture wagons, repair automobiles, but do not sell any of the latter. The trade has not been hit as hard by the auto here as elsewhere. They handle the Studebaker, Babcock line and the Michigan Buggy makes. The members of this firm were formerly with A. Wrenn & Sons.

A. Wrenn & Sons, 24 Union street, report the retail buggy line as dull, but the wholesale end as in pretty fair condition and is opening up well for the spring trade. They turn out 5,000 jobs a year of all kinds and make 150 to 200 wagons for the retail trade. The firm is also assembling automobiles, buying the parts and putting them together here and have been selling them under the name, the Wrenn.

E. P. Thomas, of 540 Chapel street, does general work in building and repair lines and has enlarged every year for six years. Is very busy now.

George Thomas, 553 Chapel street, has enlarged his business in carriage and wagon, by opening up a business of horseshoeing and putting rubber tires on automobiles.

The Todd Implement Co., 118 Church street, is handling some carriages and does a wholesale business in wheels, hubs and spokes.

SOME SOUTHERN NOTES.

Ed. Lamon, of Greenville, Tenn., at the head of the Lamon Wagon and Carriage Mfg. Co., of Bristol, Tenn., will establish a hub and spoke factory at Dalton, Ga.

The Jackson (Tenn.) Carriage Co. was incorporated, with a capital of \$15,000, to take over the Franklin Carriage Co., and will be headed by J. J. Christie, E. G. Parrish and others.

R. S. White, F. C. Duffy and Pierce Danewood have bought the old dimension wood working plant at Jeffries, W. Va., and will erect buildings and manufacture wagon rims, hubs, etc.

The wagon industry of Winston-Salem, N. C., now has a combined output of \$519,000 a year.

The Bearden Carriage Co. succeeds the Bearden-Chenoweth Carriage Co., of Nashville, Tenn., and increased its capital from \$10,000 to \$20,000.

The Etowah Vehicle Mfg. Co., was incorporated at Rome, Ga., with a capital of \$30,000 by J. H. Rhodes and Lewis R. Smith, to manufacture buggies, wagons and fire apparatus.

John M. Welch, R. F. Baker and R. L. Hill will build a spoke factory at Sparta, Tenn., with \$40,000 capital.

The Mogul Wagon Works at Hopkinsville, Ky., will increase its capital and build new factory, to have steam heat, electric light, and will lay railroad tracks for the yard, dry kilns, etc., to cost \$50,000.

The Southern Carriage Works at Emporia, Va., W. S. Drewry, president, are installing machinery for a general carriage building and repair plant.

The Franklin Buggy Co. has been organized at Barnesville, Georgia.

T. J. McDonald, of Elbemar, near Asheville, N. C., wants to buy spoke and hub mill machinery.

W. A. Mangum, of Uvalde, Texas, has let a contract for the rebuilding of the wagon and buggy factory, which burned, to be one story in height, 60x90 feet in size and to cost \$4,500.

PERSONAL.

H. G. Brown, formerly with the Brockway Carriage Co., has gone with Rauch & Lang, Cleveland.

Edward Van Gorden, foreman in the wheel department of the Champion Wagon Company, Owego, N. Y., suffered a slight shock while at work in the shop.

Frank Lanning, connected with the Salisbury Wheel and Manufacturing Co., Jamestown, N. Y., has been injured by being thrown into some of the machinery. Elbow and shoulder bones were broken.

Monte L. Greene, who holds down the job of vice-president of a trust company in Auburn, keeps in touch with his old carriage trade friends by attending banquets of the Carriage Makers' Club of Cincinnati.

W. C. Anderson, president of the Anderson Carriage Company, builders of the Detroit electric, says: "It is very gratifying to us the way the manufacturers of gasoline cars are beginning to buy electrics for their own use."

W. D. Thurston, of the Conboy Carriage Company, Toronto, Canada, has severed his connection with that firm, after fifteen years' service, and, in connection with C. W. Whitmore, he will go to the Toronto Automobile Top and Body Co.

John Sewell, Jr., a wagon builder, has been chosen by ballot as a proper man for postmaster of Fishkill, N. Y. The election was held at the suggestion of Congressman Fish, who thought it a good way to choose from among four candidates for the place.

G. W. Brode, who has represented the D. M. Sechler Carriage Company as traveling salesman for 23 years, has severed his connection with the concern, and will go to Los Angeles. He expects to take life easy for a time, enjoying a vacation to which he believes he is entitled.

Frank W. Hammond, assistant secretary and sales manager of the Lansing Wagon Works, has been promoted to the position of manager. J. B. Boyce, who has been secretary and treasurer

of the wagon works, but who has resigned to go with the Auto Body Co., was presented with a leather upholstered chair by the employees in the shops.

At meeting of directors of the Salisbury Wheel and Manufacturing Company, Jamestown, N. Y., the resignation of Clare A. Pickard as a member of the board was accepted, and Benjamin S. Dean, who recently purchased the holdings of Mr. Pickard in behalf of himself and other stockholders, was chosen to fill the vacancy. The action of Clare A. Pickard against Scott H. Penfield has been discontinued as an incident to the transfer of Mr. Pickard's holdings.

To Russell E. Gardner, president of the Banner Buggy Company, belongs the honor of having given the largest individual contribution to the fund of the Lakes-to-the-Gulf Deep Waterway Association. In a letter inclosing his check for \$500 to President W. K. Kavanaugh, Mr. Gardner says: "With the completion of your plans, this great waterway will even take precedence over the Panama Canal and I believe that while the business interests at large appreciate the wonderful and widespread interest created by your organization, they have yet to fully realize the proportion and magnitude of the proposition which the association has in view."

VEHICLES BECOMING EVANSVILLE'S BIG INDUSTRY.

Evansville, Ind., has made great strides in ten years in the vehicle business.

Already the Hercules Buggy Company is recognized as one of the factors in the vehicle trade.

With five other plants on its factory site and two more under consideration the Hercules Buggy factory is growing faster than any other manufacturing industry in the city. More than 1,100 men are employed in the plant and practically all of these are working night and day.

Two of the factories, the wheel factory and the body factory are working twenty-four hours, two crews shifting each morning and evening.

Automobile body manufacture has recently been taken up and by manufacturing a good substantial machine the company is building up an extensive automobile business.

The Karges Wagon Company, with its superior wagon and heavy draft vehicles, is becoming more than a state industry.

THE CLUB ELECTS GOVERNORS.

The regular meeting of the Carriage Makers' Club of Cincinnati, Ohio, was held at the Grand Hotel on March 10, with an attendance of sixty-two members.

Mr. Shipley, chairman of the special committee appointed to assist the Tariff Board in the regulation of export duties, made a very interesting report. The committee was authorized to continue the work.

This meeting was the occasion of the annual election of members of the board of governors. Of the eight nominees, the following were elected: David B. Gibson, Jason Schnider, A. J. Sebastiani, C. W. Shipley.

CINCINNATI BOOMING.

According to H. H. Nelson, the new president of the Carriage-makers' Club, the present season gives promise of being one of the best in the history of the industry at Cincinnati. He believes it is fair to estimate that at least 100,000 buggies will be put out this season.

HASSETT & DODGE TO LEAVE AMESBURY.

It is reported from Amesbury, Mass., that the Hassett & Dodge carriage manufactory is obliged to move from its present quarters, and as a suitable factory cannot be obtained in the town, the concern will probably leave town.

Trade News From Near and Far

NEW FIRMS AND INCORPORATIONS.

The Galloway-Mandt Wagon Co., has been organized at Waterloo, Ia.

Foster Electric Co., Marinette, Wis., will engage in the electric vehicle business.

John F. Dackins, Mankato, Minn., will engage in the implement and vehicle business.

McAlester Carriage & Wagon Company, McAlester, Okla., has incorporated; capital, \$25,000.

New Cumberland, Pa., is to have an automobile factory at an early date. No particulars as yet.

Anniston, Ala., is to have its first buggy factory in the near future. Funds have been subscribed.

The H. T. Conde Co., Indianapolis, Ind., implements and vehicles, has incorporated; capital, \$10,000.

Grosbold, Bartingale Co., hardware, implements and vehicles, of Eau Claire, Wis., incorporated; capital, \$4,000.

Cass Auto Truck Co., Port Huron, Mich., is organized and \$40,000 stock subscribed. H. G. Barnum is president.

The Elwell Peters Co., of Springfield, Neb., has incorporated to carry on a hardware, implement and vehicle business.

The Keller Manufacturing Company, Minneapolis, Minn., is building a wagon factory in northeast Minneapolis, to cost \$100,000.

Jackson Hardware Co., Menominee, Wis., hardware, implements, vehicles, gas engines, etc., has incorporated; capital, \$10,000.

The M. E. Frazier Co., Seville, Ohio, implements, vehicles, etc., has incorporated; capital, \$30,000. Incorporators M. E. Frazier, H. A. Day, H. W. Frazier, E. T. Overderf and T. E. Taylor.

Detroit, Mich., will soon have installed the Grabowsky Power Wagon Co. The buildings are to cover nine acres, and the claim is already made that it will be the world's largest.

The Owosso (Mich.) Motor Co., in which local business men are interested, has incorporated with a capital of \$200,000. The company will manufacture motor delivery wagons.

Clarke Power Wagon Co., Lansing, Mich., is organized for \$500,000. It will absorb the Ferguson Motor Co. and Clark & Co., including plants and equipments. Frank G. Clark is the president.

The Journey Mfg. Co., Portland, Ind., vehicles, has incorporated; capital, \$50,000. Incorporators W. I. Journey, J. K. Journey, J. A. Long, L. G. Holmes, N. B. Hawkins, J. F. Lafollette and J. W. Mills.

At Detroit, Mich., the Stuart Auto Car Co. has incorporated for \$300,000, of which \$60,000 is paid up for models, etc. Incorporators are Wm. M. Walker, Alexander F. Walker, M. B. O'Brien, J. Stuart, W. E. Stuart and C. H. Brooks.

At Franklin, Va., a new buggy company, not yet named, has been organized with \$50,000 capital. Expects to turn out work by September. The following are the officers: John D. Abbitt, president; L. R. Jones, vice-president; Walter F. Story, secretary.

The Bearings Company of America has filed articles in Jersey City, N. J., capital, \$1,000,000. Place of doing business not yet announced. Incorporators are William B. Greeley, John H. Hertzler, Ambrose L. O'Shea, Edward F. Rochin, all of 38 Park Row, Manhattan; Charles V. Tuthill and Thomas A. Rennick, of Jersey City.

Wichita (Kansas) Motor Car Co. is organized with \$100,000 capital. Continental Engine Co., of Chicago, will supply the motors. New car to be called the Wichita. Instead of the

transmission power being attached only to the rear axles, as is the case with other machines, the power will be equalized on both front and rear axles.

A new \$300,000 Detroit company, to manufacture motor trucks and delivery wagons, is being organized by Detroit capitalists. It will be called the Oliver Motor Car Co., and the principal shareholders will be Louis W. Schimmel, secretary and treasurer of the Tivoli Brewing Co.; Paul Wagner, dealer in brewers' supplies; Henry Wagner, Henry Wagner, Jr., and Christ Wagner, of the Wagner Baking Co.; Charles Brushaber and Robert Hartenstein.

IMPROVEMENTS AND EXTENSIONS.

Emery Skinner, Adel, Iowa, has increased repository space. Lamons Wagon Co., Greenville, Tenn., will establish a plant at Bristol.

Hercules Buggy Co., Evansville, Ind., is adding a pole and shaft factory.

Hopp Carriage Co., Mifflinburg, Pa., has added a new lumber house to plant.

Hahn & Bros.' reconstructed factory at Hamburg, Pa., is nearing completion.

Defiance Carriage Co., Defiance, O., is negotiating to rebuild on extensive scale.

Buckeye Wheel Co., Galion, Ohio, has installed a plant to make auto wheels.

H. R. Farrant, Beloit, Wis., has added a line of farm implements, vehicles, etc.

Anderson Carriage Co., Detroit, Mich., increased capital from \$1,000,000 to \$1,200,000.

Gramm-Logan Motor Car Co., Bowling Green, O., is erecting a new \$215,000 building.

Detroit Carriage Co., Hamtramck, Mich., increased capital from \$50,000 to \$100,000.

Davenport (Iowa) Auto and Tire Co., dealers, is opening a branch at Cedar Rapids.

The Falls City Buggy Top Co., Louisville, Ky., increased capital from \$2,000 to \$5,000.

Velie Motor Vehicle Co., Minneapolis, Minn., has erected an 80x110, five-story addition.

Northwestern Radiator Co., Sauk Center, Minn., has added a factory to make wagons, sleds, etc.

The F. A. Ames Buggy Company, of Owensboro, Ky., has opened a sales room in Henderson.

Reliance Motor Truck Co., Owosso, Mich., is erecting a new 750 foot building in which to make bodies.

Cortland Motor Wagon Co., Cortland, N. Y., has quarters with Cortland Wagon Co., and is now turning out work.

Keller Mfg. Co., Minneapolis, Minn., has put up a \$42,000 addition to factory, one story brick and steel structure.

Stockholders of the Anderson Carriage Co., Anderson, Ind., has voted a stock increase from \$100,000 to \$200,000.

The Michigan Buggy Company, Kalamazoo, Mich., has begun the erection of a large addition to its works. This will consist of a building 80 feet wide and nearly 350 feet long, three stories in height.

The Joerns-Thiem Motor Car Company, St. Paul, Minn., has purchased the old Brace furniture factory plant in St. Anthony Park, and will remodel it for the manufacture of commercial and touring automobiles.

Henderson-Hull Co., Savannah, Ga., has changed name to Hull Mfg. Co., and capital will be increased to \$100,000. The change of name results from the fact that Mr. Charles P. Hen-

derson, who was formerly connected with the carriage manufacturing plant, has been out of the business for slightly more than a year.

BUSINESS CHANGES.

Waugh Carriage Co., Cambridge, Mass., is now Penniman & James.

Beardsley & Son, Clarkson, Mich., implements, vehicles, etc., sold out to R. A. Urch.

Wilson Burley, Harris, Ia., implements and vehicles, has been succeeded by George Bauer.

Charles Southardt, Bangor, Mich., implements and vehicles, has sold out to Charles DeHaven.

Eller Wagon Works, Houston, Texas, succeeds Frank Eller Co. They make business wagons.

Willerton & McKain, Dalles, Ore., have purchased the vehicle business of W. A. Johnston & Sons.

H. E. Donk, Big Stone, S. D., hardware, implements and vehicles, has sold out to W. G. and C. F. Kottke.

P. R. Peterson, Montfort, Wis., hardware, implements and vehicles, has traded his stock to Baxter & Rollins.

John Moreland, Austin, Minn., agricultural implements, and vehicles, has sold out to W. A. Murray, of Chester, Ia.

W. B. Merriam, Walworth, Wis., has purchased the implement and vehicle business of the Citizens' Lumber & Fuel Co.

Barclay & Clift, Viola, Wis., hardware, implements and vehicles, admitted one Short under the name of Barclay, Clift & Short.

J. Z. Rogers, Austin, Minn., has purchased the interest of Wm. Teeter in the Austin Carriage Works, and will conduct the business alone.

Wm. Hennessey, Gagetown, Mich., has bought Wm. Burrows' interest in the blacksmith and wagon business and will continue business at the same stand.

H. H. Opperman, Strawberry Point, Ia., implements, vehicles, etc., sold out to his brothers George and Ernest, who will operate as Opperman Brothers.

The Mallory Carriage Company has leased Lanpher Bros.' carriage shop located on South Grant street, Carthage, Mo., and will move the Mallory works to that location.

BUSINESS TROUBLES.

Thomas G. Broderick, Middletown, Conn., has filed voluntary petition.

Lake Bros., Barbee Mfg. Co., Cleveland O., dealers in carriage supplies, have filed assignment papers. A. J. Schur was named as assignee.

John J. Eichhorn, Middletown, O., has been cited to court for refusing to vacate a part of the premises recently sold to the New Decatur Buggy Co.

Chester R. Head, Cortland, N. Y., has brought a negligence case against the Cortland Carriage Goods Co. Plaintiff was hurt by falling against a saw.

H. H. Harris, receiver for New Decatur Buggy Co., Middletown, Ohio, having filed report, states business was injured on account of introduction of cheap automobiles.

At a receiver's sale Attorney John A. McCormick purchased the manufacturing plant of the Petrel Motor Car Company, Milwaukee, Wis., which went bankrupt recently. The price was \$24,100.

Because of excessive damages the judgment of the Jefferson Circuit Court in the case of the Kentucky Wagon Manufacturing Company, Louisville, Ky., appellant, against Oscar Shake, appellee, was reversed by the Court of Appeals.

The case of the Wilson Moline Buggy Co, Moline, Ill., vs. Hawkins, in which it was held by the Supreme Court of Kansas that a foreign corporation doing an interstate business in that state is amenable to the corporation law of the state, has been appealed to the United States Supreme Court.

FIRES.

John Conway & Co., Morganfield, Ky., dealers in vehicles, burned out.

Austin & Figgins, Villisca, Ia., implements and vehicles, burned out.

Damage to extent of \$200 was done by fire to Orrock Carriage Works, Denver, Colo.

Felix Brunelle, Pawtucket, R. I., carriage maker, sustained \$12,000 fire loss. Uninsured.

Williams & Mair, Lebanon, S. D., implements and vehicles, burned out. Loss about \$50,000.

Burman & Dalberg, Amery, Wis., implements and vehicles, burned out. Loss \$18,000. No insurance.

Fire destroyed three story building occupied by the C. Priebe Carriage Co., at St. Joseph, Mo. Loss, \$5,000.

Slight fire in office of Sechler Carriage Company, Rock Island, Ill., was stopped in time to avert considerable damage.

Fire destroyed the warehouse belonging to Pope & Prachet, Brownsville, Tenn., and a stock of buggies and wagons.

Fire caused about \$1,500 damage to the Hamilton Carriage and Wagon Works, in Hamilton Township, N. J. The fire started in the office and completely destroyed that part of the plant.

THE BIG CONSOLIDATION.

The United States Motor Co., the \$16,000,000 merger which, having already taken in the Maxwell-Briscoe Motor Co. and the Columbia Motor Car Co., is scheduled shortly to absorb a substantial list of makers of tires, bodies, engines, parts and accessories, according to the Motor World, with perhaps several more car makers for good measure, held a meeting on February 1, when permanent organization was effected, with Benjamin Briscoe, the head of the Maxwell-Briscoe Company, as president. The other officers chosen include John B. Maxwell, first vice-president; Henry W. Nuckols, vice-president; Carl Tucker, treasurer; J. W. Wellington, assistant treasurer; F. J. Dorman, secretary; W. F. Crosby, assistant secretary. As in the case of President Briscoe, the offices held by Maxwell, Wellington and Dorman in the new organization correspond to those they hold in the Maxwell-Briscoe Motor Co., while Nuckols is vice-president and general manager of the Columbia Company.

The big company becomes the general sales agent for all lines manufactured by its constituent companies. According to President Briscoe, however, this does not mean that all the lines which eventually will be manufactured by the constituent concerns are to be marketed by the same dealers.

HURT IN RUNAWAY.

W. A. Tuttle, vice-president of the Marshalltown (Ia.) Buggy Company, was badly injured March 26 when his horse became frightened at a street car and started to kick. In attempting to avoid the animal's heels, Mr. Tuttle either fell or jumped from the buggy and sustained a compound fracture of the right ankle. The bones of the ankle pierced the flesh at the instep and the foot was turned completely back. Mr. Tuttle will be confined to his room for several weeks as a result of the accident.

TO MAKE BLOCK LETTERS.

Those who desire to master the art of making block letters will find the following suggestions of great assistance. Draw six horizontal lines forming five spaces, each of exactly the same width. Then divide these with vertical lines, forming small square blocks of equal size. Then practice on the plain letters A, B, C, D. The same series of square blocks will answer for E, G, H, I. For letters K, L, M, N, etc., lay out the vertical guide lines same as before, but run horizontal lines consisting of two parallel lines at top and bottom and one pair across the middle.

Mr. Towner, Champaign, Ill., has sold his wagon shop to G. Foltz.

Recently Granted Carriage Patents

Fifth Wheel for Vehicles. Matthew M. Sherwood, Scranton, Pa. No. 953,717. Patented April 5, 1910.

A fifth wheel with a top bearing plate formed ring-shaped, with a bottom bearing plate with upstanding projections, and having a groove, a depending projection carried by the top bearing plate having a groove, anti-friction balls in the grooves, an upstanding member carried by the top plate, a recess formed between the upstanding member and the top plate, a securing

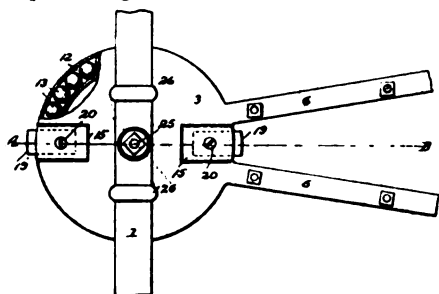

member with two arms, one of the arms projecting into the recess formed between the upstanding member and the top bearing plate, the other projecting beneath the bottom plate, a plurality of inwardly projecting lugs carried by the ring beneath the upper surface, a bolster securing member having a central boss-like portion with a plurality of arms projecting and adapted to engage the inwardly extending projections carried by the ring.

Wind Shield for Vehicles. Cowles Tolman, New Haven, Conn., assignor to the Holcomb Co., New Haven, Conn. No. 953,723. Patented April 5, 1910.

A wind shield comprising an upper and lower sash, hinges in-

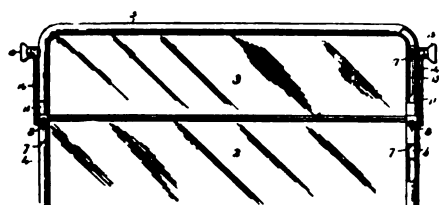

terposed between the sashes, the hinges comprising a lower stump formed with an outwardly projecting arm, an upper stump hinged to the lower stump, the upper stump slotted, a link pivoted to arm and adapted to be clamped to the upper stump through the edge of upper sash.

Adjustable Wind Screen for Use on Vehicles. Charles Steane, Coventry, England. No. 953,804. Patented April 5, 1910.

A wind screen the combination of a stationary member, an

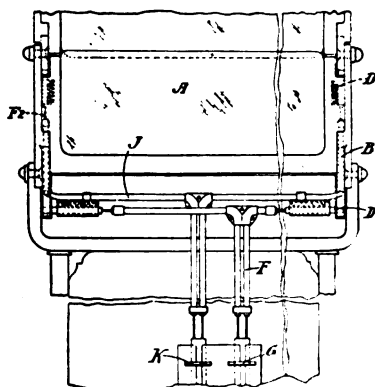

adjustable screen member hinged to the stationary, a quadrant having openings carried by the hinged screen member at one side, and adapted to turn therewith, a spring-pressed detent slid-

ingly arranged on the stationary member and adapted to engage within the openings in the quadrant, an operating wire for the detent secured thereto, and a pedal to which the wire is connected.

Automobile Wheel. Thomas J. Sparks, San Francisco, Cal., assignor of one-half to Uncle Sam Automobile Co., Phoenix, Ariz., and one-half to Edward C. Ray, San Francisco, Cal. No. 954,144. Patented April 5, 1910.

A wheel, the combination of a tire, felly, spokes, hub consisting of a flanged tubular member having threads on one

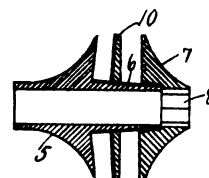

end and being pyramidal from the threaded portion to the flange which has its surface toward the threaded end conical, a flat ring having a series of depressions on each side of the set at a phase difference of one-half, and a flange having a part of its interior threaded and adapted to screw on the end of the tubular member and the remainder of its interior polygonal.

Demountable Rim. Eli J. Bushey, New York, N. Y. No. 954,375. Patented April 5, 1910.

A wheel having a felly with band surrounding a rim for carrying the tire, a split clamping ring interposed between the band and the rim, means for fastening, the clamping ring to the felly

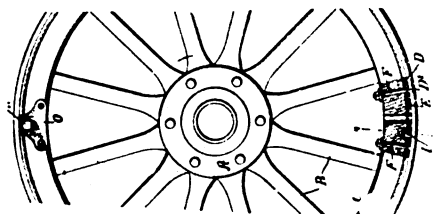

at points approximately opposite the free ends of the ring, a lug carried by the rim and extending through the ring and band into engagement with the felly, and manually controlled means for spreading the clamping ring.

Securing Device for Wagon End-Gates. Ludwig Hillan, Wentworth, S. D., No. 954,392. Patented April 5, 1910.

A securing device for an end gate, comprising a cross-bolt,

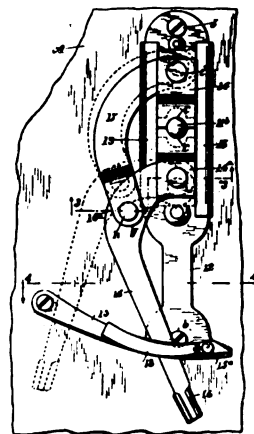

having a grip piece on one end, the bolt passing through the sides of a wagon body near a transverse end gate, a base plate secured on one side board, two undercut guide flanges on base

plate, two nut blocks slidably mounted on the base plate beneath the guide flanges, each nut block having a concaved end and threaded in concavity, a rockable lever having a curved and pivoted at end on one nut block, a link bar curved edgewise and pivoted at its ends respectively on the curved end of the lever and the other nut block, and means for detachably securing the lever when rocked for closure of the nut blocks.

Demountable Rim for Automobile Tires. William N. Booth, Cleveland, O. No. 954,416. Patented April 5, 1910.

The combination of a fixed rim, a demountable rim adapted to fit closely thereon, the parts having inclined engaging surfaces,

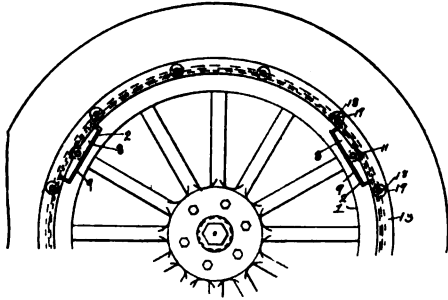

a pair of lugs on demountable rim, a worm and wheel locking device intermediate between pair of lugs and mounted in fixed rim, and adapted and arranged to engage pair of lugs to force demountable rim on and off from fixed rim.

Vehicle Top Rest. Patrick Henry, Dallas, Texas. No. 954,571. Patented April 5, 1910.

A vehicle top rest, in combination with a cylindrical sleeve, provided with inwardly extending radial slots at each extremity, and having a square, central orifice with which slots communicate, a curved loop spring, the loop portion of which inclines

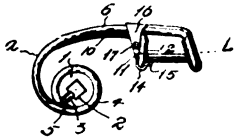

sharply downward and the extremities of which are coiled and finally secured one in each of slots of the sleeve, a second curved looped spring similarly shaped but shorter, whose ends are similarly secured one in each slot of the sleeve, the two looped springs extending in the same direction, and a concave saddle plate having its front portion secured to the downwardly deflected loop of the longer spring, and its rear extremity secured to the loop of the shorter spring.

Whiffletree Hook. Charles E. Jones, Windsor, Mo. No. 954,810. Patented April 12, 1910.

In combination with a whiffletree having a recess formed at one end, a ferrule fitted over the end of the whiffletree and forming one wall to recess, an integral lug projecting from the cir-

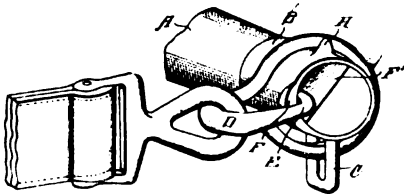

cumference of ferrule, the latter having a laterally projecting reinforced portion upon the outer surface of the part forming the wall of the recess, a whiffletree hook having a shank portion formed into a ring fitted over ferrule, means for holding ring upon the latter, one end of the hook being adapted to engage the inner face of that portion of the ferrule forming the wall of the recess.

Bolster Spring. Henry J. Noll, Milwaukee, Wis. No. 955,673. Patented April 19, 1910.

A vehicle bolster spring, having bearing brackets adapted to be mounted upon the vehicle bolster, cranked rods carried by the bearing brackets, semi-elliptical main springs supported by

the cranked rods, parallel bolster bars secured to the springs, and tie plates connecting the bolster-bar ends; the combination of a centrally disposed hanger extending crosswise of the bolster bars, a spring-seat carried by the hanger intermediate of the bolster bars, clip-bolts for the hanger bolster bars, and semi-

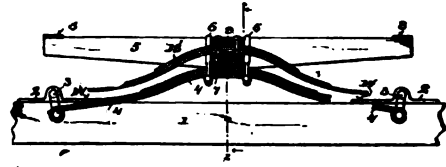

elliptical springs, an auxiliary semi-elliptical spring fitted to the hanger seat, clip-bolts for securing the auxiliary spring to hanger seat, the auxiliary spring being approximately parallel with the main spring and having its ends adapted to contact with the vehicle bolster under a maximum load strain.

Wheel-Rim Securing Means. Otto R. Schoenrock, Chicago, Ill. No. 955,213. Patented April 19, 1910.

The combination with the felly of a wheel, of an outer rim, a resilient tire secured thereto, an inner rim having a groove for

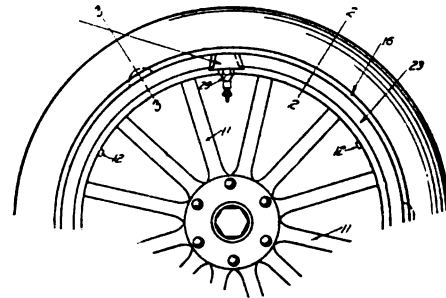

the reception of the inturned edge of inner rim and having a flange adapted to engage outer rim, a ring secured to felly between split ring and felly, and a wedge for expanding split ring, second-named ring having a portion cut away to accommodate wedge.

Vehicle Body. Samuel R Bailey, Amesbury, Mass., assignor to S. R. Bailey & Co., Inc., Amesbury, Mass. No. 955,494. Patented April 19, 1910.

A vehicle body comprising an angle iron extending longitudinally of the side having one of its portions extending vertically,

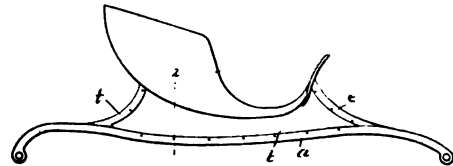

a vertically disposed sheet metal side plate rigidly secured at its lower edge portion to vertical portion of iron and extending above, a wooden sill secured at one side by screws to one side of plate at the upper edge throughout its length, and a wooden side securely glued to the opposite side of sill.

Carriage Top. George W. Hendrick, Dayton, Va. No. 955,512. Patented April 19, 1910.

The combination with a vehicle top having a transverse bar,

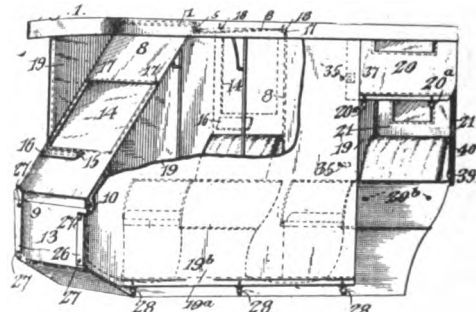

of a curtain supporting bar extending across the front of the vehicle top and arranged adjacent to and in advance of the

transverse bar and having its ends rounded at their upper edges angular brackets secured to the transverse bar and to the supporting bar and connecting the latter with the former, curved metallic hangers secured to and fitting the rounded ends of the supporting bar and depending below the lower edge and having bearings, and a curtain provided with a roller mounted in the bearings.

Pneumatic Spring Suspension for Vehicles. George A. Rhoades Urichsville, O. No. 955,692. Patented April 19, 1910.

A cushioning support for motor vehicle bodies comprising a U-shaped casting, embodying vertical end portions cored to form cylinders and intermediate base bar connecting the lower ends of cylinders, the bar being provided with a longitudinal

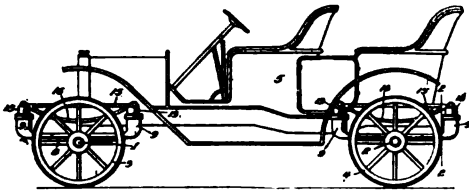

bore forming an equalizing passage communicating with the chambers of the cylinders, pistons operating in cylinders, a bar pivotally connecting pistons, and a brace depending from the bar into the space between the pistons and providing means of attachment to the body supporting part of a vehicle.

Wheel Hub. William W. Cork, Naper, Neb. No. 956,041. Patented April 26, 1910.

The combination with a wheel hub having a counter-bored opening, there being radially extending apertures within the hub and opening into the counterbore and opposing shoulders adjacent each opening, a spindle projecting into the hub, there being an enlargement upon the spindle and forming a shoulder within

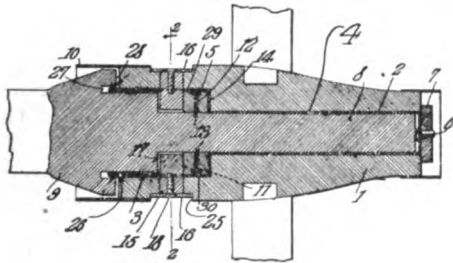

the counterbore, a collar secured to the spindle and within the counterbore, a band surrounding and detachably secured to the hub, and tapered dogs secured to the band and removably mounted within the openings and normally projecting between the shoulder and collar, each dog having oppositely extending wings normally seated upon the shoulders adjacent the openings.

Wagon Brake. Henry C. Murdock, Clapper, Mo. No. 956,134. Patented April 26, 1910.

A wagon brake comprising, in combination with a wagon box, a curved bar fastened at its ends to the box and having outwardly bent portions with an intermediate part parallel to and

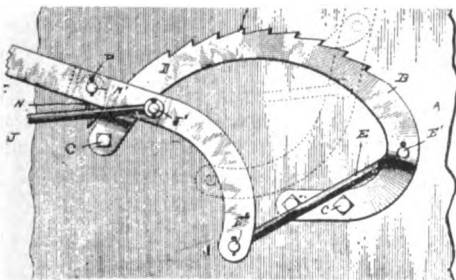

spaced from the box, the upper convex edge of the bar having ratchet teeth, a rod having angled ends, one of which is pivotally connected to the bar, a lever pivoted to its other end, a pawl carried by the lever and adapted to engage the teeth of bar, an angled plate fastened to lever with its ends engaging.

RECENTLY GRANTED PATENTS OF INTEREST TO THE CARRIAGE TRADE.

- 943,729—Whip Lock. W. H. Beach, Wyncote, Wyoming.
- 944,231—Buggy Body. G. H. Bertsch, assignor of one-half to E. E. Sanders, Freeport, Ill.
- 943,764—Spring Running Gear for Automobiles. C. P. Boomer, Muncie, Ind.
- 943,811—Detachable Rim for Vehicle Wheels. P. G. Challiss, Forest Hill, England.
- 943,655—Vehicle Top Joint Brace. J. C. Coss, Cleveland, Ohio.
- 944,080—Wagon Brake. E. G. Doland, Starksboro, Vt.
- 944,184—Tip for Wagon Poles. A. Fischer, Chokio, Minn.
- 943,674—Apparatus for Oiling Fellies. D. D. Frisbie, Detroit.
- 943,742—Running Gear for Wagons. C. M. Haeske, South Bend, Indiana.
- 943,744—Automobile Driving Mechanism. C. B. Hatfield, Jr., Oshkosh, Wis.
- 943,680—Motor Car. W. S. Hovey and C. B. Stebbins, assignors to Sheffield Car Company, Three Rivers, Mich.
- 944,199—Wheel Fender. T. W. Mayson and J. Edgar, Auckland, New Zealand.
- 944,201—Whip Socket. J. A. Musgrove, Jr., assignor of one-half to C. H. Patterson, Norton, Va.
- 944,143—Wagon Reach Coupling. C. Myers, Springport, Mich.
- 943,889—Ventilating Device for Vehicles. F. B. Pope, Augusta, Ga., and W. J. Lester, Boston, Mass.
- 943,998—Flexible and Elastic Band for Pneumatic Tires. P. Rousillon, Argenteuil, France.
- 944,151—Brake Mechanism. E. Santsche, assignor of two-fifths to J. A. Prentice and one-fifth to J. Bagley, Eureka, Cal.
- 944,058—Brake-Equalizing Mechanism. F. D. Thomason, Chicago, Ill.
- 944,114—Singletree. G. F. Thompson, Minneapolis, Minn.
- 944,351—Vehicle Wheel Rim. J. M. Alderfer, Sharon Center, O.
- 944,532—Wheel. D. H. Allen, Miamisburg, Ohio.
- 944,936—Combined Wheel Hub and Spindle. T. A. Barnett, Manifest, La.
- 944,308—Automobile Tire. W. J. Bauer, assignor to Bauer Non-Collapsible Wheel Company, New York, N. Y.
- 944,309—Vehicle Wheel. W. J. Bauer, assignor to Bauer Non-Collapsible Wheel Company, New York, N. Y.
- 944,773—Steerable Sled. F. W. H. Clay, Pittsburg, Pa.
- 944,539—Wagon Rack Standard. L. P. Cook, Clarendon, N. Y.
- 944,600—Driving Gear for Motor Vehicles. A. R. Corrington, assignor of one-half to G. E. Knaack, Hartley, Iowa.
- 944,544—End-Gate Fastener. T. M. Dice, Paxico, Kas.
- 944,956—Draft Appliance for Self-Propelling Vehicles. D. Dunlap, La Junta, Colo.
- 944,603—Vehicle Brake. F. A. Eigenmann, Newark, O.
- 944,722—Making Inner Liners for Tires. B. S. Eshelman, assignor to G. V. Krichbaum, Ashland, O.
- 944,426—Mounting or Suspension of Vehicle Bodies. C. W. Fulton, Paisley, Scotland.
- 944,852—Wheel Attachment for Sleds. O. Fyelling, Crookston, Minn.
- 944,783—Vehicle Shield. J. Hadka, Chicago, Ill.
- 944,264—Evenser and Whiffletree Coupling. C. A. Henniecke, Buffalo, N. Y.
- 944,446—Shock Absorber for Vehicles. F. G. Koehler, St. Louis.
- 944,799—Pitch Board. C. E. Lytle, St. Joseph, Mo.
- 944,801—Brake Lever Mechanism for Carts and Wagons. G. Manlove, Rushville, Ill.
- 944,891—Farm Wagon. C. H. Mickelsen, Bench, Idaho.
- 944,899—Spring Clevis. C. Mullin, Conway, N. D.
- 944,813—Running Gear for Wagons. W. J. Ott, Merlin, Oregon.
- 944,906—Detachable Rim for Pneumatic Tires. P. Petracchi, Varese, Italy.
- 944,514—Rim for Motor Car Wheels. D. C. Smith and W. F. Gorton, Muncie, Ind.
- 944,979—Whip Socket and Lock. C. Turney, Surprise, Neb.
- 944,641—Vehicle Wheel. F. P. Vaughan, Chicago, Ill.
- 944,530—Combined Whip, Rein and Lap Robe Lock for Vehicles. O. W. Wilde, Wichita, Kas.
- 944,760—Tire Remover. H. B. Young and R. Palomino, Shafter, Texas.
- 940,420—Design, Vehicle Body. W. H. Emond, Newtonville, Mass.
- 945,365—Automobile. Charles Berg, Philadelphia, Pa.
- 945,120—Automobile Sleigh. George W. Deviov, North Spencer, Mass.
- 945,122—Swivel Lamp for Vehicles. James E. Geary, Quincy, Mass.
- 945,515—Device for Laying Off Wooden Axles. George W. Golding, Lodi, N. Y.
- 945,037—Tire. David Hays, assignor to E. B. Stimpson, New York, N. Y.

- 945,169—Vehicle. John Johnston, assignor to J. Johnston Company, Hyde Park, Mass.
 945,330—Vehicle. John Kelly, Jamaica Plain, Mass.
 945,396—Automobile Tire. Iva B. Kempshall, Boston, Mass.
 945,725—Vehicle Spring. Charles A. Lieb, New York, N. Y.
 945,470—Tire. Byron W. Meredith and O. Wildman, Morrisville, Pa.
 945,134—Axle. Wm. M. Nash, Norfolk, Va.
 945,190—Shock Absorber. John H. Otten, Buffalo, N. Y.
 945,594—Whiffletree Clip and Hook. John Pierson, Ingersoll, Okla.
 945,613—Vehicle Chock. Theodore Scherf and H. W. Merrick, Cleveland, O.
 945,058—Supplemental Wheel. Milton D. Stocking, Lindenwood, Ill.
 945,352—Making Rubber Fabric, Adna D. Warner, Mishawaka, Ind.
 945,353—Rubber Tubing for Tires, Adna D. Warner, Mishawaka, Ind.
 945,649—Tire Protector. James C. Warring, assignor to G. V. Krichbaum, Ashland, Ohio.
 945,650—Attachment for Hearses. George B. Webb, Kinston, N. C.
 945,145—Singletree Clip and Trace Fastener. Benjamin F. Whetsell, Elkins, W. Va.
 945, 115—Vehicle Tire. Edmond P. White, Chicago, Ill., assignor to White Tire Company.
 946,091—Spring Wheel for Vehicles. Wm Ackerman, Sapulpa, Okla.
 945,836—Change Speed Gearing. James H. Apjohn, London, Eng.
 946,338—Carriage Lamp Box. Russell E. Cole, Democracy, O.
 946,112—Vehicle Wheel. Benson P. Cooper, Ithaca, N. Y.
 946,023—Shaft Support. John Eherenman, Mentone, Ind.
 945,945—Coupling for Double and Single Trees. Samuel B. Hazard, Peoria, Ill.
 945,783—Neckyoke Fastener. Addison P. Hoard, Alcester S. D.
 946,044—Wheel Tire. Howard H. Hodgson, Toronto, Ont., Can.
 946,145—Motor Vehicle Brake. Henry M. Lyman, Philadelphia.
 945,966—Tire Heating Device. Julius A. Mahr, Minneapolis, Minn.
 946,465—Steering and Motor Controlling Mechanism for Automobiles. Charles Schmidt, assignor to the Peerless Motor Car Company, Cleveland, O.
 946,405—Draft Equalizer. Franklin M. Smiley, Goshen, Ind.
 945,824—Wheel, Thomas H. Walbridge, Toledo, O.
 946,182—Roller Bearing Axle, Martin Wille, Chicago, Ill.
 946,479—Vehicle Truck or Running Gear. Wm. S. Wills, Covington, Va.

Copies of above patents may be obtained for fifteen cents each, by addressing John A. Saul, Solicitor of Patents, Fendall Building, Washington, D. C.

RECENTLY EXPIRED PATENTS OF INTEREST TO THE VEHICLE INDUSTRY.

Patents Expired March 14, 1910.

- 493,354—Steering Device for Vehicles. Frederick E. Degenhardt, Chicago, Ill.

Patents Expired March 21, 1910.

- 493,677—Spring Gear for Vehicles. William Bonnar, Mono Mills, Canada.
 493,764—Two Wheeled Vehicle. Daniel S. Gallatin, New Berlin, Ohio.
 493,863—Seat for Wagons. Charles Goeller, Elmont, N. Y.
 494,008—Vehicle. Leopold Landreth, Bristol, Pa.

Patents Expired April 4, 1910.

- 494,584—Vehicle Wheel. Joseph P. Manton, Providence, R. I.
 494,628—Running Gear for Vehicles. Henry M. Crippen and John M. Crippen, Athens, Ohio.
 494,645—Wagon Brake. Alfred T. Newell, Anderson, S. C.

Patents Expired April 11, 1910.

- 495,014—Two Wheeled Vehicle. Willie S. Bull, Buffalo, N. Y.
 495,277—Vehicle Tire. George F. Stillman, Syracuse, N. Y.
 495,330—Horse-Attaching Device. Charles E. Harris, Brandon, Canada.
 495,367—Vehicle Hub. Robert G. Petway, White Bluffs, Tenn.
 495,443—Vehicle Axle. Thomas Rodecker, Mendon, Ohio.

The above lists of patents, trade marks and designs of interest to our patrons are furnished by Davis & Davis, solicitors of American and foreign patents, Washington, D. C., and St. Paul Building, New York City.

W. A. Murray, Chester, Iowa, bought the implement and vehicle business of Anderson & Brown, of Austin, Minn.

NEW CARBURETOR.

M. Fancon, a gentleman who has done efficient work in the improvement and simplification of carburetting apparatus, has designed a new one to which he has given his name. The outline illustration, with the description will explain its merit. The design provides a gasoline jet standing in a hollow cone, through which air rushes. The jet itself is tapered, as shown in the accompanying diagram at A, and the coned air sleeve which surrounds it is indicated by B. The main air intake is at C, the air passing into the chamber D, where it separates into two currents. One, the major, rushes up outside the sleeve B and meets

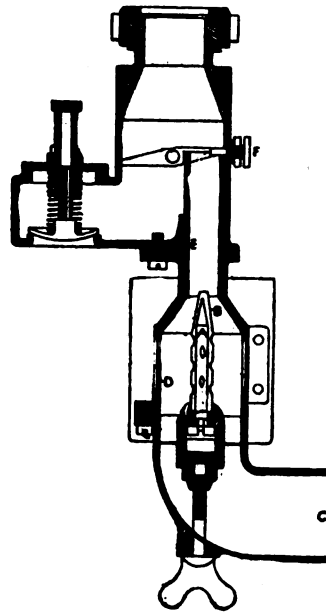

the mixture which is formed by the minor current that enters the sleeve through holes and passes the jet to issue into the choke tube (E). About one-ninth of the total quantity of air entering the choke-tube does so through the sleeve B. Thus a rich mixture is first formed at the top of the sleeve, and this is diluted where met by the major air current in the choke tube, for, be it noted, the top of the sleeve extends into the choke-tube. The formation of the mixture therefore takes place in a region free from eddies.

FREEZING GLUE.

If a pot of glue is placed in a position to freeze, and carefully watched, it will be found to first freeze around the edge—that is, where the liquid lies against the pot, just as will a vessel of water. On the top there will be noticed a thin coating of ice, which will in a short time reach to the bottom of the pot, around edge. If not allowed to freeze farther, and used in this condition, there will hardly be any noticeable difference; but let the pot of glue remain in a freezing temperature long enough to freeze it entirely through, then used, do not be surprised if your work falls to pieces. Glue jelly frozen in this way will crumble much the same as stale bread will, and will give about the same results as overcooked glue. It is not advisable to let glue freeze at all, for in doing so you are taking chances of having poor work.

BE CAREFUL.

It makes some difference with the insurance people about how electric wiring is done, so unless you know the business pretty thoroughly yourself, also the insurance regulations, it is cheaper and better to turn the job over to an expert electrician.

SIMPLIFIED RULES FOR SETTING TOPS.

When making tops for individual bodies or ordered work, it is necessary to make the top up on the job. Unless the mechanic has had considerable experience at this kind of work, he will be

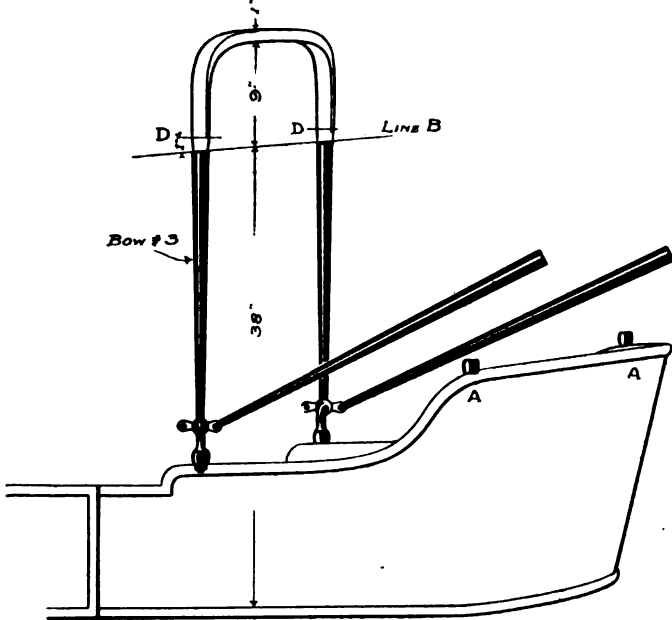

FIG. 1

sure to waste a great deal of time setting up the bows, even if he does not spoil stock through inexperience.

Assuming that the body has been correctly ironed and that we are to use bow sockets, we first determine the width of the bows, by allowing 1 inch clearance each side between the inside

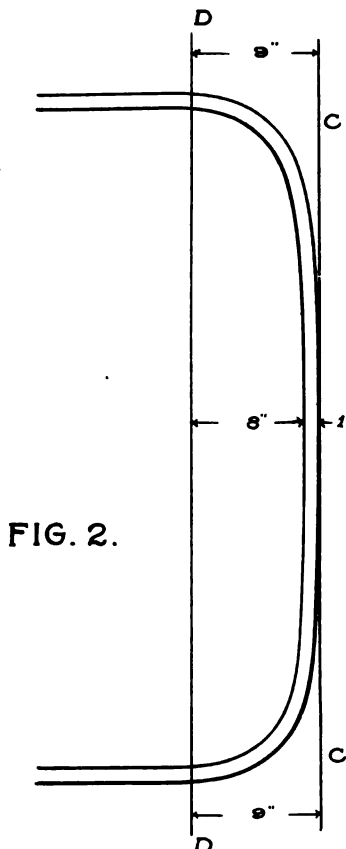

FIG. 2.

of bow and the outside of socket AA. Having determined the height of the top as 47 inches from under side of bow to top of seat frame of rear seat, we place the bow sockets in position on the rear seat, as shown in illustration, Fig. 1, and hold the three bow sockets perpendicular, laying a straight edge across the tops

on line B, and measure down to the seat frame, which in our illustration is 38 inches. We now take our bundle of bows and before removing the stays thereon make several pencil lines across all the bows near one side, to distinguish or mark one side so that when setting up the bows, the marked side will be on the same side of the top. This is the safest way as sometimes bow corners have different bends. The bows are then laid on the floor as shown in Fig. 2, and from the chalk line CC measure down and place a line across the bows that will come above the top of the bow socket, in this case we have used 9 inches, see DD, Fig. 2.

As the bow is 1 inch thick, D, Fig. 2, will be 8 inches from the underside of bow, and as shown on Fig. 1, we require 9 inches to complete the required height from the top of the bow sockets, we therefore add 1 inch to point D which will then correspond to line B, Fig. 1. Now clamp the wood bow to the bow socket making the corresponding marks meet and then drop the bow to determine if 47 inches height will allow sufficient clearance over the back, which in this case we have 3 inches. We now measure off on the bow from line B down, and cut off at point just determined, and fit bow into the socket. Proceed in the same manner with the perpendicular bow on the front seat and set up the other bows in the customary way from a straight edge laid lengthwise of the body and resting on the top of the two perpendicular bows.

NEW WHEEL WORKS AT BURLINGTON, IOWA.

W. G. Mercer has severed his connection with the Buffington Wheel Works at Burlington, Iowa, and will erect a new wheel manufacturing plant on the east portion of the ground occupied by the Burg Wagon Company. The company will be incorporated at about \$100,000, the new factory to be in operation by September 15. The Buffington Wheel Company will continue in business under the direction of the Burlington Wheel Company, which has been incorporated with a capital stock of \$10,000. The incorporators and directors are: N. G., W. H. and E. H. Oods, of Fort Wayne, Ind., and C. G. Guild, of Burlington. The latter will serve as secretary and treasurer.

BAKER'S MOTOR DELIVERY.

The success of Mr. Hopkins of the George Irving Co., in designing commercial motors is again shown in this example of a baker's wagon intended to carry an almost unlimited quantity of pie to the hungry. The back and side loading doors give access to pie racks conveniently arranged. The chassis is of the 3-ton class, with power enough to make speed deliveries.

EXTRACTING SPOKE STUBS.

In removing stubs of old spokes from hub, use a lag screw with a good thread. Bore hole in spoke one size smaller than screw. Turn screw in with wrench until point of screw hits box, and, unless the spoke is rotten, the screw will shove the stub out.

TO BUST THE TRUST.

Suit has been started at Milwaukee, Wis., by the Belie Vehicle Co., of Moline, Ill., to break up the alleged trust in the automobile business by which practically every American manufacturer refuses to allow plaintiff the use of certain patents essential to manufacture automobiles.

TAXICAB TRAVELING WEST.

A taxicab proposition is before a number of Bay City (Mich.) business men and it will come up for further consideration. It gives promise of being worked out successfully. If the proposition is entertained local moneyed people will be asked to take stock and start the enterprise going.

LAMBERT AUTOMOBILES.

(Illustrated on Page 33.)

We illustrate two of the latest models of the Lambert car, made by the Buckeye Manufacturing Co., which are marketed at a moderate price. The two-passenger car, model 17, is the cheaper in cost. There is nothing unusual in the design of either car. The lines conform to the practice that seems to be almost standard. The use made of the rear part of chassis for tank and traveling trunk is a good use. The four passenger car is comfortable in appearance, giving ample leg room, and is much like all other cars of a similar class.

The chassis and power plant is also shown for the purpose of illustrating the friction drive, which is the exclusive patented device controlled by the makers. It has been always used, but is latterly much perfected in detail. It simplifies the transmission problem very much, and also simplifies the troubles of the car driver. The frame is light and well reinforced, and the suspension is easy and comfortable for the passengers. There is a mechanical motor starter as part of the plant. The car has been very well received, and is a step in advance in the matter of simplicity of detail—something very important to car users.

THREE-TON DELIVERY TRUCK.

(Illustrated on Page 35.)

Through the courtesy of Mr. George Hopkins, who has so successfully designed a number of vehicles of this character, we present this month a delivery truck that has a body combining lightness, strength and excellence in design. The inside length is 14 feet, width 6 feet 2 inches, and height from sills 6 feet 6 inches. The details are well exemplified in the illustration.

CHEAP AND NOVEL.

The illustration shows a construction of motor in combination with platform and high wheels that could be made interesting as a cheap runabout for small journeys that were undertaken in the course of the daily routine of business life. A vehicle for little money for little journeys.

It consists of a couple of large solid-tired wheels, connected by an axle from which hangs a platform sufficing for the engine, fuel tank, and two persons. The engine, which is at the rear, is of the single-cylinder type and develops $4\frac{1}{2}$ H.P. The counter-

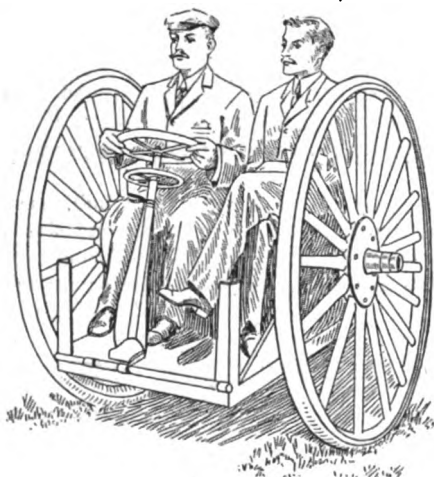

shaft lies parallel with the axle of the vehicle, and on the ends are a pair of roller chains driving sprockets that engage with the wheel hubs. The steering is accomplished by an ordinary auto steering wheel, which actuates wires that move friction discs between the sprockets and the wheel hubs, the drive being released from one wheel or the other to effect a turn.

The chief features of this machine is the cheapness with which it can be built and the lack of vibration that results from the use of large wheels. The seat for the driver and passenger rests just over the axle.

CHASSIS SPRINGS.

The carriage builder does not occupy the same position with regard to the supply of complete motor car as he has done with the horse-drawn carriage, says the Automobile and Carriage Builders' Journal, of London. With the motor car, as with the horse carriage, it is not his business as a rule to guarantee the efficiency of the motive power, but, in addition to this, the automobile has taken out of his hands the manufacture or supply of the wheels, springs, and axles, and their immediate accessories, all of which were highly developed departments in the carriage building shops of yesterday. He is, therefore, fully equipped in most instances with the knowledge of those things as applied to road vehicles, and he will also have had the opportunity of watching the wear and tear of various designs as applied to motor cars, and as he has been supplanted in this particular branch of the business his opportunities to criticise the practice of those with shorter experience has naturally been taken full advantage of. The motor car manufacturer does not seem to have made up his mind as to what constitutes the best chassis suspension. At present he is inclined to be freakish. With the front suspension he is unable to experiment to any extent owing to the proximity of the engine and bonnet, also the pivots of the front axle and wheels which have to lock, so that a grasshopper spring is standard practice in this portion of the chassis in 99 cases out of 100. Coming to the back axle one finds many interpretations of what a spring should consist. Two side, two side and a cross, imitation C's with or without braces, three-quarter elliptic with or without a scroll, full elliptic, either ordinary pattern or with shackled eyes, while the innovation of a well known Coventry firm suggests that types of coil springs in conjunction with existing patterns are now to confront us, which is, of course, an adaptation from railway and tramway practice. The correspondence on this subject shows that the motor body builder resents complications and fancy shapes, because as a practical moulder of road vehicles, he knows their weaknesses, which in the hands of some motorists may lead to suggestions that his bodies are too heavy; he also has experienced their obstruction in precluding good design when they protrude above and close to the chassis side members. Motor cars have to withstand greater road shocks than horse equipages, simply because of the greater speed at which they are driven, the greater weight of the vehicle as a whole, and the longer distances travelled, therefore one must be prepared to look for a difference in suspension, but this surely will take the direction of something stronger, yet equally as resilient. The consensus of opinion goes to show that the side spring is best suited as a hind spring, taking into consideration that it bears most of the weight, also some of the strains of the driving wheels, which is in accordance with the suspension of heavy horse vehicles, such as omnibuses and large wagonettes, where the greater weight is borne on the hind axle.

WILL MOVE TO BETTER QUARTERS.

After June 1 next Louis Dusenbury & Co., Inc., 79-81 Worth street, New York City, will occupy fine quarters in the New Belvidere building, corner of Eighteenth street and Fourth avenue. The Dusenbury company are jobbers of upholstery materials for carriages and automobiles.

HENNEY BUGGY CO. MAKES MUSIC.

The band of the Henney Buggy Co. has been fitted with spick and span new uniforms, and the band has become a member of the American Federation of Musicians.

NEW FACTORY.

A \$30,000 factory building of three stories is to be erected in Milwaukee, Wis. The dimensions of the structure are 100x150 feet. It is to be occupied by the C. Abresch's Carriage Company.

FRICION DRIVE.

Henry Sturmev, in *Motor*, (London) in discussing friction drive thinks that for light cars, we shall ultimately get a means of friction driving which will not only be cheaper and vastly simpler to the complicated gears of to-day, but quite possibly less wasteful of power. Because a mechanical construction is wanting in some respects to-day, it does not by any means follow that it must necessarily be so to-morrow. If it were so, the gasoline engine would be a failure, for in the earlier attempts to propel motor cars by internal combustion engines the difficulties were severe and success was by no means certain. And in this matter of frictional transmission of power it is possible to-day to do much that a decade since would not have been considered feasible, and when we come to the simplicity of it, of course, there is only one in it, i. e., frictional transmission.

We know that belt drive was one of the earliest systems of power transmission employed in automobiles. The belt-driven cars of a decade back were not as satisfactory as they might have been, and when we come to look at the conditions under which belts were used, this is not at all to be wondered at. But I have seen a car with a belt transmission so arranged that it was quite as satisfactory in the car as belt driving is in a machine shop, and we know that 99 per cent of the machinery is belt driven. It was the condition under which belts were at first set to work which were at fault and gave the system a bad name in motor construction.

There is no reason why a belt drive should not be as satisfactory in a car as it is in a workshop, and when it comes to the point of view of simplicity, there is no question about its superiority. And so it is with other forms of frictional transmission. The same general condemnation is meted out at their very mention, yet success or failure is largely due to choice of material and conditions of work, and with a steady improvement in materials and conditions the objections which once existed are vastly reduced, and I believe it is possible to so contrive a frictional transmission of power as to make it more economical and at least as generally satisfactory as the more expensive and more complicated methods now generally approved.

As a matter of fact, our cars themselves are actually frictionally driven, so far as the contact between their driving wheels and the ground is concerned, and so are our railway trains, so that it cannot be said that power cannot be transmitted economically by friction in traction work. Broadly speaking, there is one great point of advantage which is characteristic of them all, that is to say, the possibility which they present for slip when the stresses become too great. They thus form in themselves an automatic clutch. The belt, as we know, will slip, and doubtless there is always a little slip going on, but with properly treated belts, broad enough surfaces and sufficient length in the belt, with both belt and pulleys thoroughly protected from wet and mud, there is no reason why a belt transmission should not be as satisfactory as any other.

The failure of the earlier belt-driven cars was due, first, to the conditions under which they were employed, being run in the middle of the car, entirely unprotected and just where they would get a copious stream of mud and water thrown on to them by the wheels. Then, untreated belts were used, the constructors of that day overlooking the different conditions of use as compared with belts run in the interior of a good workshop, and so they employed just the same plain belts used there, and special treatment of belts only began to be considered about the time the then drawbacks of the system had commenced to assert themselves and put it out of favor. Then, again, the belts used were far too narrow and also too short. In other words, practically every principle requiring consideration to secure successful use was ignored, and the only wonder is that they answered so well as they did.

Those few engineers and others who studied the subject and gave the needful attention to the points required, succeeded in getting belts to run with perfect satisfaction over lengthy periods of time, and to-day there are a number of belt driven cars

doing steady, regular service. Of course, to employ belt transmission an entirely different design of car, that is to say, in the arrangement of an engine, is necessary, as the crankshaft or driving shaft must be parallel to the driven shaft, which, in itself—mechanically considered—is infinitely sounder and more correct arrangement than that pertaining to-day, with which it becomes necessary to transmit the power round a right-angled corner, by means of a bevel or worm gear, themselves heavily absorptive of power.

Then we have the disc system, which has been experimented with for years, and which has been brought to a point of very fair practicability. This, however, is not by any means so simple or so sound a system as the last mentioned, but it possesses the attractiveness of combining in itself that theoretical desideratum of power transmission by infinite gradation in the gear ratios.

Broadly speaking, the system consists in transmitting the power between two discs set at right angles to each other, and one of them movable radially over the face of the other. Except for attractiveness of the infinite gradation of ratios, I question if this system would receive, or would have received, much consideration, because it is not so direct as the other and the power has still to be taken round a corner. The system is largely used in America.

In America, while there are not many touring cars constructed on the system, it is employed in quite a number of commercial vehicles, and it appears to answer its purpose well. They have, however, there, in the most successful types, adopted a system of compromise, the gear is so arranged that, at its maximum, the drive is not taken frictionally, but positively, the cars having practically a direct drive on top, doing, as with most cars of to-day, nine-tenths of them running on the top gear, with speed variation by engine speed control and only bringing the friction discs into play for starting up and for climbing hills, a system which greatly lessens one of the principal objections which is, that the constant running over one line of surface results in wear along that line and so put the disc out of adjustment when other portions of the disc surface are under the drive. Theoretically, too, the system is, in some respects, contradictory, that is to say, while, to obtain efficient transmission without undue wear, large surface contact is requisite, if a broad edge to the rolling wheel is provided, every portion of it will be in contact with a portion of the surface of the disc face which is revolving at a different speed, so that throughout the whole period of drive, there must be a constant movement going on between the surfaces, which can only result in wear.

Wear has been considerably reduced in later years by a judicious selection of materials, and other attempts to overcome the difficulty have been made by modifying the design of the discs, all, however, involving complication and taking away from the system one of its chief attractions, viz., simplicity and cheapness of production, but the system, broadly, still has its attractiveness in its power for infinite gradation of speed ratios. This latter characteristic, however, is by no means so important or so valuable from a practical point of view as was the case a decade since. Theoretically, of course, we should employ the smallest engine capable of doing the work, and as quite a low-powered engine will propel a car at a good pace on the level, provided we can reduce the ratio sufficiently to enable it to get that load up hills, if we are not desirous of speed on gradients, but only of "getting there and home again," it would appear that a small engine with a gear infinitely variable from zero upwards, would be the most desirable. But human nature is human nature, and this idea of economical work to-day is very largely thrown to the winds, because men are not content with crawling up hills, but require to travel up quite respectable gradients at a decent pace, and hence as time has gone on, we have come to put comparatively large power in our cars, and, to a very large extent, and by moderate gear ratios, to do away with the necessity for variable gearing, and with the majority of cars to-day three-speed variations—and with many two alone—are considered quite sufficient, if engine power available and ratio

in relation to work are dealt with to that end. Hence the work for the friction transmission designer, is, to a large extent, simplified, as the public are content with a car which shall have power enough to do all that is needed in a day's work with a minimum of speed variation by alteration of gear ratios.

In addition to the above, we have the extremely simple method of the roller drive. Just hardened steel rollers, grooved to give us as much surface as possible, carried directly by the engine shaft, driving directly by frictional contact with suitably surfaced rings, attached directly to the wheels themselves. Here we have a very close approximation to an absolutely direct drive. Indeed, we have actually a perfect direct drive where transmission mechanism at all is employed, because, of course, an absolutely direct drive would be the mounting of the wheels on the ends of the crankshaft itself.

This form of transmission comes about as near to that as it is possible to get it. All parts are revolving in the same direction, and the rollers being given a fairly high speed in relation to their path, the stresses on the frictional surfaces are reduced apparently to a practical point. It is true the surface of frictional contact is small, but the "V"-shaped grooving adds to it, and there is a wedging action of the grooves to assist. Now, when we look at this—or, indeed, the belt drive—with the two main objections to frictional transmission, i. e., excessive absorption of power and rapid wear of surfaces, in mind, it will be seen, I think, that, while taken alone there may be considerable frictional loss in transmission, when the directness of the application is taken into account I question very much indeed whether the total loss in transmission from engine to road surface is anything like so much as are the aggregate transmission losses under the ordinary system.

We have in the latter losses in shaft bearings and further losses through the gear where the direct drive is not employed, and where it is we still have the greatest loss of all, viz., that which is necessitated by working with a right-angled transmission through the differential, and we have further losses in the bearings of the live axle shafts in their casing, all of which, added together, amount to an appreciable figure, whereas, applied directly, as the roller drive is, all these losses are eliminated, with the exception of the friction of the engine bearings and of the extended crankshaft in the bearings of its carriers, and, of course, the friction of the rollers upon their rings. I can conceive, therefore, that, if the different losses in the two systems were carefully investigated, the advantage might well be on the side of the simpler construction, in spite of the theoretical insufficiency of the contact drive. And so far as the question of wear is concerned, this is all a question of degree. Every moving part wears, and gearwheels, differentials, and bevels, in transmission mechanism, as well as the many bearings through which the respective shafts run, are all subject to wear, and when gearwheels or bevel wheels or bearings are worn, their renewal becomes an expensive matter.

The roller drive is carried in very much the same position as a chain, although the rollers are protected to a certain extent by their rings. Still, they are subjected to the contact of much grit, and this, of course, will tend to wear them away, and the only question therefore, to be decided is: how long this wearing process will take before the rolling surfaces are rendered inefficient and require renewal? Here, as with the disc drive, it is largely a question of choice of material, and if by this means such surfaces are secured which will last a reasonable time, then we only have to consider the trouble and work of replacement and the cost of same, and it seems to me that these latter points for consideration will weigh very slightly against the system, for the parts should be both easy and cheap to renew, just, in fact, as a broken belt is an easy matter to restore and an economical one, provided only it will last long enough, so that, when all is said and done, if all the facts are carefully weighed against each other, it will be seen that the gear transmission does not possess such a remarkable preponderance of advantages over the simpler and cheaper methods alluded to above,

and it may even ultimately come to be proved that the balance of advantages goes hand in hand with low cost and simplicity, in which case, of course, although there would be an enormous amount of innate prejudice to overcome, we might eventually see an entire revolution in the ultimate car design.

ARTIFICIAL HAND WARNING.

We notice an interesting arrangement that may be applied to a two-passenger car, the device being formed of two sliding panels, one projecting from each side of the car. On the tablet or panel is painted an extended hand held up as a warning to the following vehicle after the usual manner. These tablets are worked from the drivers seat by separate levers, and can be operated instantaneously on either side. The opening in the framing is covered by a lip on the front edge of the tablet, and when closed can only be detected by close scrutiny. The hood of the car has two small windows so placed as to give the driver clear vision as to what may be overtaking him.

THE SMITH'S JOB.

Backed by natural ability and good, common mechanical sense the practical smith cannot help but make good on automobile work. Practically every new case of breakdown presents a new problem. Therefore, a good commonsense understanding of automobile construction and principles is the essential, rather than how to repair every one of the long list of accidents likely to happen to a motor vehicle.

Don't get the idea that you cannot repair automobiles. You don't know until you try. And then the most important reason of all is profit.

ITS FIRST CAR.

The Rock Hill (N. C.) Buggy Company has begun the assembling, painting and trimming of automobiles, and will incorporate motor cars as a branch of the business.

Wants

Help and situation wanted advertisements, one cent a word; all other advertisements in this department, 5 cents a word. Initials and figures count as words. Minimum price, 30 cents for each advertisement.

SITUATIONS WANTED.

Wanted—High class position by foreman trimmer now employed. Plenty of experience on all classes of auto and carriage work. Best references. Address 42-C care The Hub, 24 Murray street, New York, N. Y.

HELP WANTED.

Wanted—Bodymaker-draftsman on wood and metal automobile bodies. State age, education, experience and salary expected, and furnish references. Address ACE, 15, care The Hub, 24 Murray St., New York.

Wanted—Superintendent for carriage and automobile body manufacturing plant, to take full charge, first class position. Reference required. Address P. O. Box 106, Station F, Cincinnati, Ohio.

Wanted—A thoroughly experienced foreman painter for high class buggy work. Age 30 to 40 years preferred. A man of good business and executive ability to work men and material profitably desired. Good references required. Address E. S. H., care The Hub, 24 Murray street, New York, N. Y.

FOR SALE.

For Sale—We are closing out the entire lot of stock of the Troy Buggy Works Co., consisting of buggy and surrey bodies, springs, axles, wheels, etc., at low prices on account of discontinuing vehicle business. Schedule on application. Must be sold at once. Write the Troy Manufacturing Co., Troy, Ohio.

PATENTS.

Patents—H. W. T. Jenner, patent attorney and mechanical expert, 608 F St., Washington, D. C. Established 1883. I make an investigation and report if a patent can be secured and the exact cost. Send for full information. Trade-marks registered.

Is Horseflesh Cheaper than Gasoline?

Motor vehicle manufacturers recognized early in the game that the greatest obstacle they had to overcome to make successful cars was friction.

They realized it was folly to have a high powered efficient engine developing power under the hood that would be used up overcoming friction in other parts of the machine, so they got busy in the right direction and replaced the old fashioned friction bearings wherever they could with

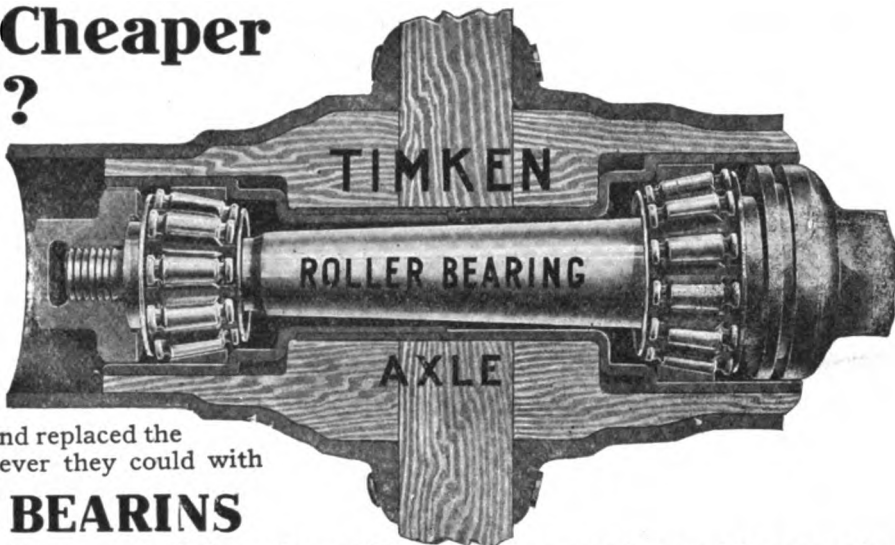

TIMKEN ROLLER BEARINGS

until to-day—say NINETY ODD (90) per cent of all the makers of high grade American Automobiles are using **TIMKEN ROLLER BEARINGS**

in part or throughout in their cars—

And yet, strange to say, some vehicle manufacturers are still building and trying to sell vehicles that are not equipped with

TIMKEN ROLLER BEARINGS

Are you one of those that believes horseflesh is cheaper than gasoline?

IF YOU DO, WRITE US FOR "FACTS."

THE TIMKEN ROLLER BEARING CO. Canton, Ohio.

Branches
10 E. 31st Street, New York
429 Wabash Ave., Chicago, Ill.

Cover a carriage top with MERITAS enameled oil cloth—cover another with any other kind—follow them up and see how long the tops last.

MERITAS will be in good condition long after the other has been caked, cracked and weather-killed.

Try it—then stick to the kind that lasts the longest.

Look on the back of the goods for our trademark.

See Your Jobber.

Standard Oil Cloth Co.
320 Broadway, New York



Painters and Decorators Save Time, Labor and Money, using the

Uebelmesser Striping and Stencil Wheel

With this simple, clean and rapid-action tool the most ordinary decorator can do the finest striping and stencil work and produce a bigger day's work with less labor than by the old fashioned method. Complete directions are furnished with each tool. They are as simple as the tool itself.

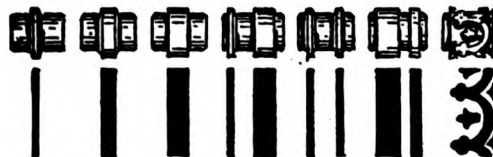

Just a few of the many designs that can be produced with the Uebelmesser Painters' and Decorators' Tool. (The designs shown above are reduced in size)

Complete Outfit consisting of Machine, 10 Plain and 10 Ornamental Wheels, only **\$5.50**
LIBERAL DISCOUNT TO THE TRADE

Manufactured by
Charles R. Uebelmesser Company
Bayside, New York, N. Y.

Please mention "The Hub" when you write.

HOTEL CUMBERLAND

NEW YORK

Southwest Cor. Broadway at Fifty-fourth St.

Near 50th St. Subway Station, 53d St. Elevated and all Surface Lines.



Headquarters for
Carriage and
Automobile Trade

Ideal Location, Near Theatres,
Shops and Central Park.

NEW AND FIRE-PROOF
STRICTLY FIRST-CLASS

RATES REASONABLE
All Hardwood Floors and
Oriental Rugs.

Ten Minutes Walk to
Twenty Theatres.

Transient Rates, \$2.50 with Bath, and up.

Excellent Restaurant. Prices Moderate.

SEND FOR BOOKLET.

HARRY P. STIMSON,
Formerly with Hotel Imperial.

R. J. BINGHAM,
Formerly with Hotel Woodward.



Richard Eccles Co., Auburn N. Y.

Manufacturers of

Forgings: Carriage, Wagon, Automobile, Special

Send for Catalogue.

TRUCK BUILDERS

If you only realized the inestimable value of roller bearing fifth wheels on trucks, vans, delivery wagons and all other medium and heavy vehicles, no job would leave your shop without

Roller Bearing Fifth Wheels

WHY? The adjustment is perfect. No oil or grease required. Almost indestructible. Will out-wear any vehicle. Saves horseflesh and prolongs life of vehicle. Ask your jobber for the celebrated

NIELSON OR KING

Let us send you Catalogue and Price List.
American Roller Bearing Fifth Wheel Co.
745 THIRD AVE., BROOKLYN, N. Y.

INDEX TO ADVERTISEMENTS.

| | |
|------------------------------------------------|-----------|
| Akron-Selle Gear Co. | 13 |
| American Ball Bearing Co., The | 2nd Cover |
| American Roller Bearing Fifth Wheel Co. | 10 |
| Bradley & Son, C. C. | 4th cover |
| Cargill Company | 4 |
| Columbus Bolt Works | 4th cover |
| Consolidated Rubber Tire Co | 6 |
| Crane & MacMahon | 2d cover |
| Devoe, F. W., & Reynolds Co., C. T. | 3d cover |
| Eberly & Orris Mfg. Co. | 3d cover |
| Eccles Co., Richard | 10 |
| English & Mersick Co., The | 2 |
| Gifford & Son, John A. | 16 |
| Goodrich Co., B. F., The | 5 |
| Hoopes Bro. & Darlington, Inc. | 2d cover |
| Indianapolis Dash Co. | 16 |
| Jones & Co., Phineas | 11 |
| Keystone Forging Co. | 11 |
| LeCompte Mfg. Co. | 15 |
| Lounsbury & Sons, G. H. | 3d cover |
| Masury & Son, John W. | 2 |
| McKinnon Dash Co. | 4th cover |
| Mercer, Geo. J. | 12 |
| Moore & Co., Benjamin | 3 |
| Moller & Schuman Co. | 3 |
| Mott Wheel Works | 3rd cover |
| Murphy Varnish Co. | 1 |
| National Spring and Wire Co. | 11 |
| Porter, H. K. | 10 |
| Russell, Burdsall & Ward Bolt and Nut Co. | 3d cover |
| Schubert Bros. Gear Co. | 16 |
| Smith & Co., Edw. | 3 |
| Spring Perch Co. | 11 |
| Standard Oil Cloth Co. | 9 |
| Standard Wheel Co. | 1 |
| Timken Roller Bearing Co. | 9 |
| Uebelmesser Co., Charles R. | 9 |
| Valentine & Company | 3 |
| West Tire Setter Co. | 16 |
| Wilcox Mfg. Co., D. | 11 |
| Willey Co., C. A. | 2 |
| Woodman, Joel H. | 12 |

Please mention "The Hub" when you write.

FIFTH WHEELS—FORGINGS

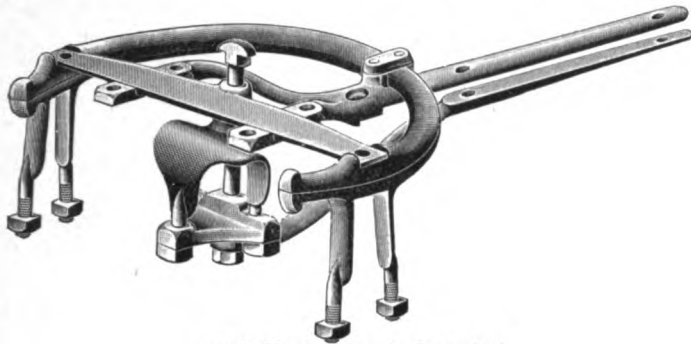

1908 Single-Reach Gear Set.



Detachable Fork Perch Connection Used in 1908 Gear Set.

Greatest Line on Earth

WHEN ORDERING GEAR SETS BE SURE TO GET THE GENUINE

Wilcox Rear King-Bolt Gear Sets

WRITE US FOR FULL PARTICULARS

THE D. WILCOX MANUFACTURING CO.

MECHANICSBURG, PENNSYLVANIA

Our Carriage or Spring Edge Cushion Frame



Is not an Experiment, but has been tried and stands the test.
We would like to quote you prices.
NATIONAL SPRING and WIRE CO.,
ALBION, MICH., and ST. CATHARINES, ONT., CAN.

Jones Wheels

BEST ON EARTH

KANTSAMORE

Phineas Jones & Co.

Newark, N. J.



PATENTED DEC. 3, 1901

THE STANDARD BODY LOOP

NONE LIKE IT NONE EQUAL TO IT

A popular body loop, unequaled by any on the market
For further information, address

The KEYSTONE FORGING CO., Northumberland, Pa.

CARRIAGE SPRINGS OF EVERY STYLE AND PAT- TERN TO ORDER

Also Curtain Rollers and Concealed Hinges
EXCLUSIVELY FIRST-CLASS WORK
THE BEST THAT CAN BE MADE

SPRING PERCH CO.

BRIDGEPORT, CONN.

Please mention "The Hub" when you write.

A \$100 Typewriter for 17 Cents a Day!

Please read the headline over again. Then its tremendous significance will dawn upon you.

An Oliver Typewriter—the standard visible writer—the \$100 machine—the most highly perfected typewriter on the market—yours for 17 cents a day.

The typewriter whose conquest of the commercial world is a matter of business history—yours for 17 cents a day.

The typewriter that is equipped with scores of such conveniences as “The Balance Shift”—“The Ruling Device”—“The Double Release” —“The Locomotive Base”—“The Automatic Spacer”—“The Automatic Tabulator”—“The Disappearing Indicator”—“The Adjustable Paper Fingers”—“The Scientific Condensed Keyboard”—all

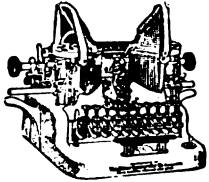

Yours for 17 Cents a Day!

We announced this new sales plan recently, just to feel the pulse of the people. Simply a small cash payment—then 17 cents a day. That is the plan in a nutshell.

The result has been such a deluge of applications for machines that we are simply astounded. Demands come from people of all classes, all ages, all occupations. The majority of inquiries has come from people of known financial standing who were attracted by the novelty of the proposition. An impressive demonstration of the immense popularity of the Oliver Typewriter. A startling confirmation of our belief that the Era of Universal Typewriting is at hand.

The OLIVER Typewriter

A Quarter of a Million
People are Making
Money With

THE STANDARD VISIBLE TYPEWRITER

The Oliver Typewriter is a money-maker, right from the word “go.” So easy to run that beginners soon get in the “expert” class. Earn as you learn. Let the machine pay the 17 cents a day—and all above that is yours.

Wherever you are, there's work to be done and money to be made by using the Oliver. The business world is calling for Oliver operators. There are not enough to supply the demand. Their salaries are considerably above those of many classes of workers.

Write for further details of our easy offer and a free copy of the new Oliver catalog. Address

The Oliver Typewriter Company

310 BROADWAY NEW YORK CITY

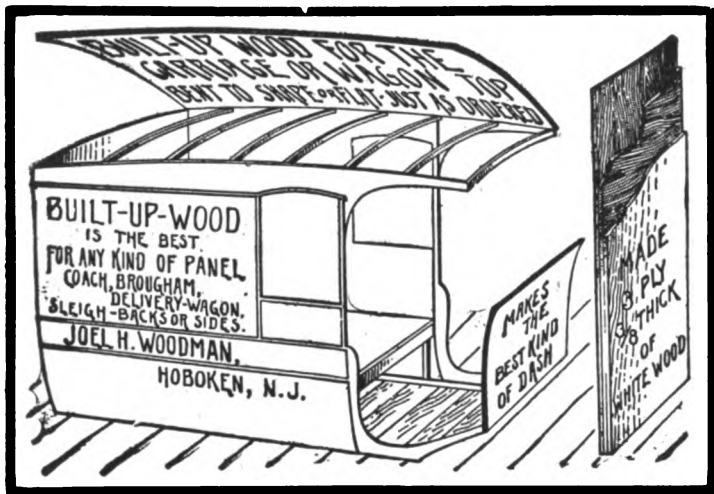

GEO. J. MERCER

Automobile Body Designer

Bodymakers' Full Size Working Drafts, of Laudaullets, Limousines, Taxicabs, Touring Car Bodies, etc.

Standard Design Drafts of the Above Bodies, of Metal Construction. Drawings Made with Inks of Different Colors on Extra Heavy Paper.

Price \$35.00

1777 Broadway, NEW YORK

Advertisements Classified

The following list includes advertisers in THE HUB. Each advertiser is entitled to name under one heading only. An extra charge for name under more than one heading.

Automobile Parts.

LeCompte Mfg. Co., New York City.

Axles, Etc.

American Ball Bearing Co., Cleveland, Ohio.

Timken Roller Bearing Co., Canton, Ohio.

Bodies, Seats, Etc.

Woodman, Joel H., Hoboken, New Jersey.

Bolts and Nuts.

Columbus Bolt Works, Columbus, Ohio.

Russell, Burdall & Ward Bolt and Nut Co., Port Chester, N. Y.

Carriage Cloths.

Wise & Co., Wm., New York City.

Carriage Forgings.

Eccles Co., Richard, Auburn, N. Y.

Keystone Forging Co., Northumberland, Pa.

Carriage Hardware.

Gifford & Son, John A., New York.

Carriage Goods.

English & Mersick Co., New Haven, Conn.

Gifford & Son, John A., New York.

Herbrand Co., The, Fremont, O.

Dashes, Fenders, Rails, Etc.

McKinnon Dash Co., Buffalo, N. Y.

Fifth Wheels.

American Roller Bearing Fifth Wheel Co., Brooklyn, N. Y.

Wilcox Mfg. Co., D., Mechanicsburg, Pa.

Jacks.

Hankinson, J. V., Franklin, O.

Lamps.

Gifford & Son, John A., New York.

Stevens & Sackett Co., New Haven, Conn.

Machinery and Tools.

Barnes Co., W. F. & John, Rockford, Ill.

Porter, H. K., Everett, Mass.

West Tire Setter Co., Rochester, N. Y.

Miscellaneous.

Standard Oil Cloth Co., New York.

Uebelmesser Co., Charles R. Bayside, New York, N. Y.

Rubber Tires.

Consolidated Rubber Tire Co., New York City.

Goodrich Co., B. F., Akron, O.

Goodyear Tire and Rubber Co., Akron, O.

Swinehart Climber Tire & Rubber Co., Akron, O.

Shaft Couplings and Anti-Rattlers.

Bradley & Son, C. C., Syracuse, N. Y.

Eccles Co., Richard, Auburn, N. Y.

Metal Stamping Co., New York City.

Springs and Gears.

Akron-Selle Gear Co., Akron, Ohio.

National Spring and Wire Co., Albion, Mich.

Spring Perch Co., Bridgeport, Conn.

Trimming Materials.

Stevens & Sackett Co., New Haven, Conn.

Varnishes, Paints and Japans.

Devoe, F. W., and C. T. Reynolds Co., New York City.

Harland & Son, Wm., London and New York.

Masury & Son, John W., New York and Chicago.

Moller & Schumann, Brooklyn, N. Y.

McCoy & Co., Benj., Cleveland, Ohio.

Murphy Varnish Co., Newark N. J.

Pierce Co., F. O., New York.

Smith & Co., Edw., New York.

Valentine & Co., New York, Chicago, Boston, Paris.

Willey Co., C. A., Hunter's Point, New York City.

Wheels.

Crane & MacMahon, New York.

Gifford & Son, John A., New York.

Hoopes Bro. & Darlington, West Chester, Pa.

Jones & Co., Phineas, Newark, N. J.

Standard Wheel Co., Terre Haute, Ind.

Wheel Stock, Bent Wood, Etc.

Crane & MacMahon, New York.

SELLE GEARS—1,000 STYLES AND SIZES



No. 60 L. Ready for body. 9 sizes— $1\frac{1}{4}$ to $1\frac{3}{4}$ in. axles.



No. 32 H. Ready for body. 15 sizes— $1\frac{1}{8}$ to 2 in. axles.

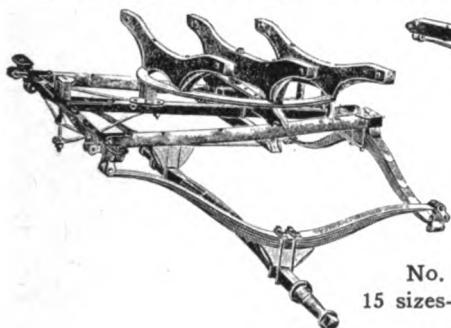

No. 16 H Clipped
15 sizes— $1\frac{1}{8}$ to 2 in. axles.

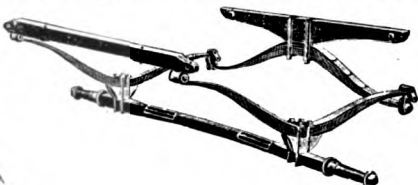

No. 40 B. L.
15 sizes— $1\frac{1}{2}$ to $2\frac{1}{4}$ in. axles.

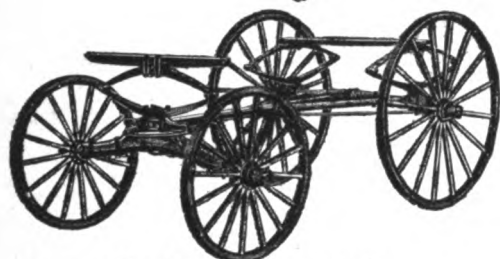

No. 301. Ready for body.
6 sizes— $1\frac{1}{2}$ to $1\frac{3}{4}$ in. axles.

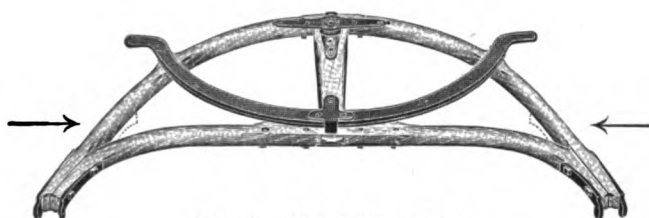

No. 0. Short Turn Gear.
4 sizes— $1\frac{1}{8}$ to $1\frac{3}{4}$ in. axles.

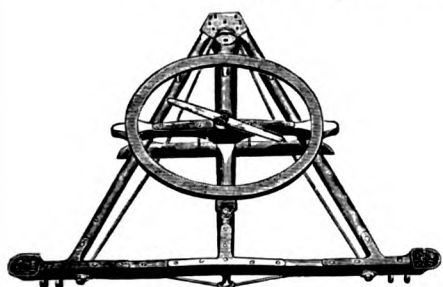

No. 11 H.
15 sizes— $1\frac{1}{8}$ to $1\frac{7}{8}$ in. axles.

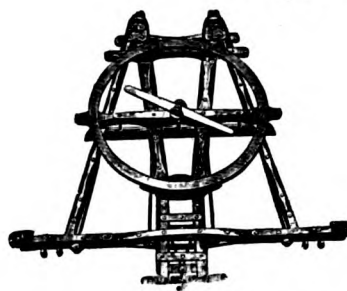

No. 52 L,
21 sizes— $1\frac{1}{2}$ to 3 in. axles.

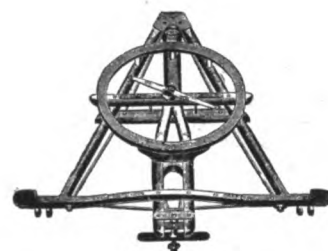

No. 36 M.
15 sizes— $1\frac{1}{8}$ to 2 in. axles.



No. 44 H.
21 sizes— $1\frac{1}{2}$ to 3 in. axles.

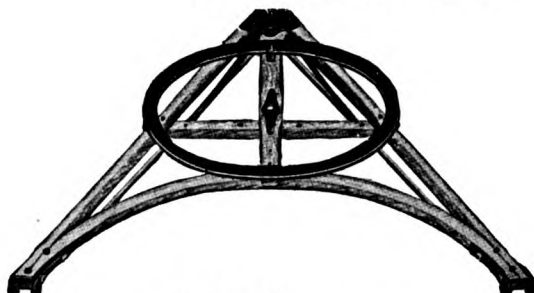

No. 3 H.
13 sizes—1 1-16 to $1\frac{1}{2}$ in. axles.

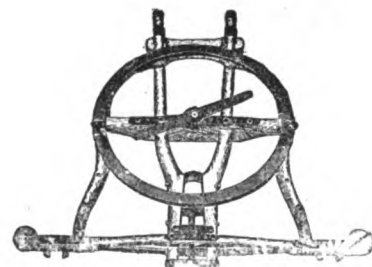

No. 64 M.
12 sizes— $1\frac{5}{8}$ to $2\frac{1}{2}$ in. axles.

WRITE FOR
CATALOG NO. 16.

THE AKRON-SELLE CO., Akron, Ohio.

Please mention "The Hub" when you write.

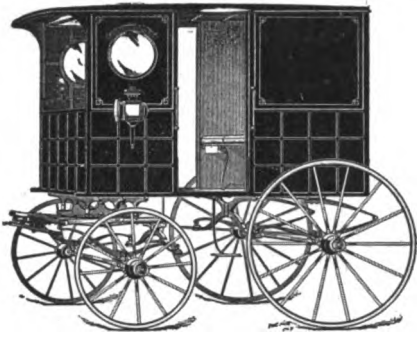

No. 112.—Milk Wagon.

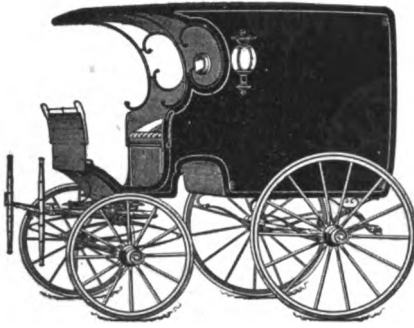

No. 111.—Altman Wagon.



No. 113.—Grocery Wagon.

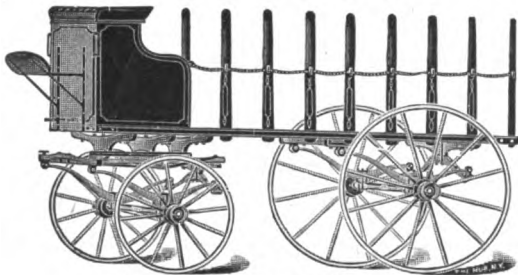

No. 122.—Flour Truck.

Electrotypes

of the vehicles presented on this page will be forwarded on receipt of

75 cts.

for each cut, to any address. Postage prepaid.

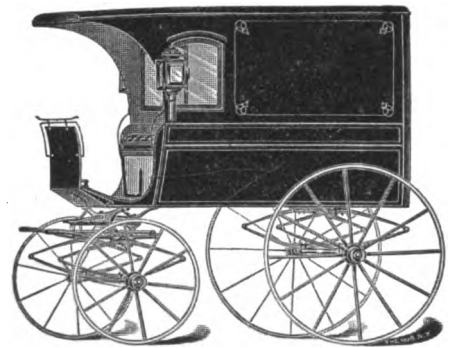

No. 115.—Delivery Wagon.

Catalogue

containing nearly 200 illustrations of carriages, wagons, sleighs, and miscellaneous cuts will be sent upon application.

Trade News Publishing Co.
24-26 MURRAY ST.
NEW YORK

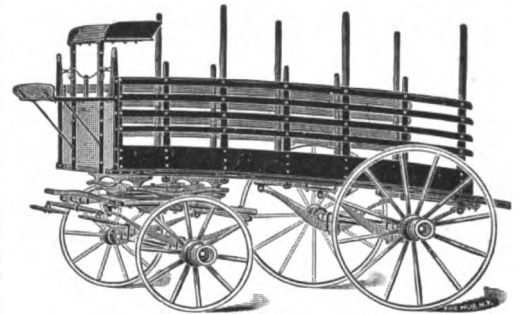

No. 117.—Merchandise Truck.

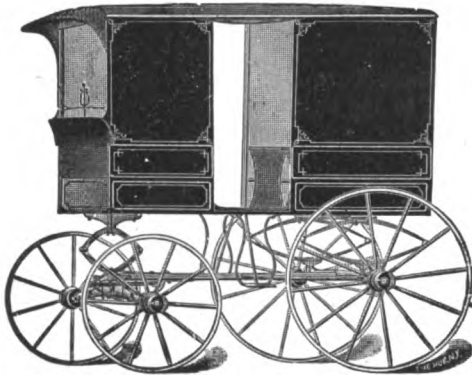

No. 116.—Milk Wagon.



No. 114.—Delivery Wagon.

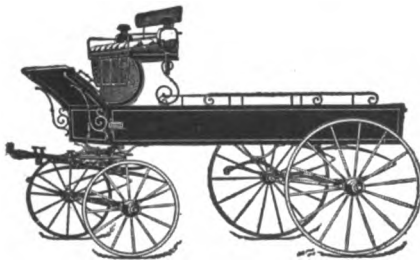

No. 124.—Delivery Wagon.

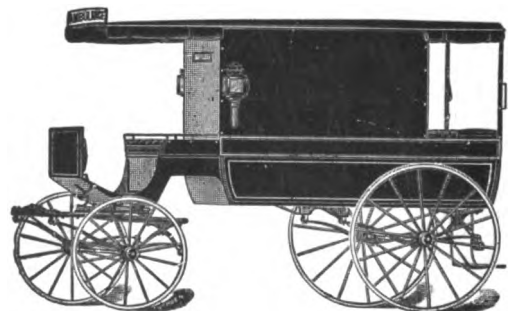

No. 118.—Ambulance.

Please mention "The Hub" when you write.

Contractors
Automobile Parts

**PLAIN
 FINISHED
 MACHINED**

CASTINGS

B^{Brass}ronze A^{luminum}utomobile BRONZE

MANGANESE BRONZE

POPE'S ISLAND

Non-corrosive Metal, Silver and Gold; Best known metal

HAND CLOSE PLATING

Seven Colors, guaranteed to last the life of car, carriage or harness.

ELECTRO PLATING

Black, White, Gold, Silver, Nickel, Brass or Gunmetal

Contracts made with car manufacturers

Horse Bits

"If it's a bit, we have it"

Write for a pair of our
 Cast Metal Silver or Gold
 Horse Bit Cuff Buttons **FREE**

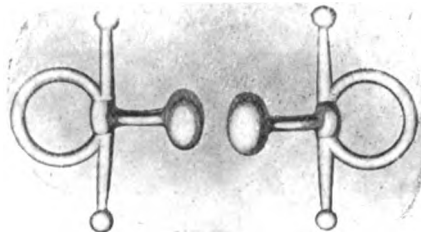

LeCompte Mfg. Co.

E. A. Whitehouse Mfg. Co.

} **Inc.**

OFFICE
 110 Chambers St., New York

FACTORY AND FOUNDRY
 44-50 Elm St., Newark, N. J.

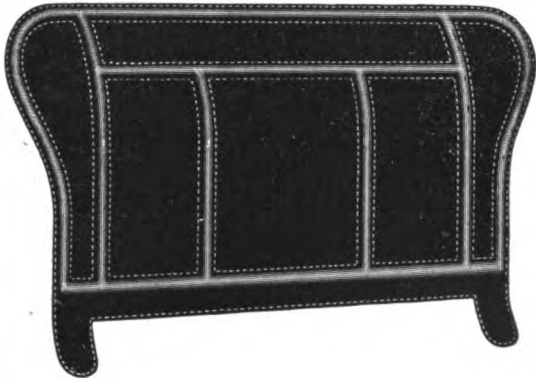

HIGH GRADE Dashes and Fenders

THE INDIANAPOLIS DASH CO.

INDIANAPOLIS

INDIANA

ESTABLISHED 1886.

Correspondence School of Carriage and Motor Carriage Drafting

A thorough, practical tuition is given through this correspondence school. The theory and practice of construction, bookkeeping, perspective. Many men now hold good positions through taking the courses of instruction.

Principal, THOS. MATTISON,
Hillside Avenue, Bitterne Park,
Southampton, England.

Author of "The Coach Body Makers' Guide," \$3.00; a practical treatise on "The Suspension of Carriages," "Bookkeeping," and other carriage building works.



Carriage Mechanics

Desiring to improve their present
Condition should attend the

TECHNICAL SCHOOL

FOR

Carriage Draftsmen and Mechanics

SUPPORTED BY THE

Carriage Builders' National Ass'n.

The object of the School is to teach men to design vehicles and make working drawings, and to otherwise facilitate their work in the shop. Only those men employed in carriage or automobile building or their accessory trades are admitted to its privileges.

The classes are conducted in three divisions, viz.: Corresponding, Day, and Evening. The former is open during the entire year, while the day and evening classes are in session only from October 1st to April 1st.

The tuition is moderate.

For prospectus and full particulars, write to the instructor,

ANDREW F. JOHNSON,

18 West Forty-fourth St.,

NEW YORK CITY.

VEHICLES AND GEARS IN THE WHITE



PREMIER
SIDE SPRING GEAR

We manufacture a full line of Carriage and Wagon bodies in the white; also Limousine, Taxicab, Touring Car and Roadster Bodies for automobiles in metal. Fifty styles of gears for Carriages and Wagons; also seats, trimmings and tops of all kinds.

Write to us for particulars.

Schubert Bros. Gear Company

ONEIDA, NEW YORK.

The WEST Hydraulic Tire Setter

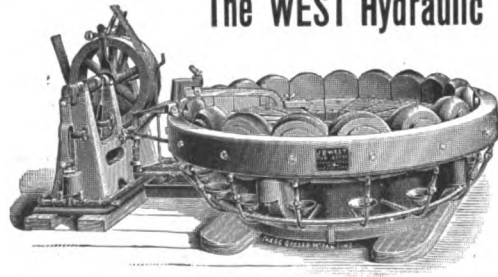

It will set a heavy tire in a minute and do it better than is usually done by the old method, and without burning or otherwise injuring the wheel. Used by hundreds of

discriminating manufacturers and repairers throughout the United States and Canada. Write us for Catalogue with list of users.

WEST TIRE SETTER CO.,

ROCHESTER, NEW YORK

Please mention "The Hub" when you write.

F. W. DEVOE & C. T. RAYNOLDS CO.

101 and 103 FULTON STREET, NEW YORK

Manufacturers of

F. W. DEVOE & CO'S {
COACH COLORS
VARNISHES
BRUSHES
SPECIALTIES

C. T. RAYNOLDS & CO'S {
COACH COLORS
VARNISHES
BRUSHES
SPECIALTIES

FOR PAINTERS, ARTISTS AND DECORATORS

All the brands and specialties of F. W. Devoe & Co. and C. T. Raynolds & Co. will be maintained separately as heretofore.

WIRE WHEELS

TO FIT EMPIRE BALL BEARING AXLES

Quality Unsurpassed

Write Today

The Mott Wheel Works

UTICA, N. Y.

Brazil Leather

FOR AUTO BUGGY TOPS

SEAT AND BACK SPRINGS,
COTTON, NAILS, WADDING,
MOSS, TACKS, WASHERS,
HAIR, BUTTONS, REEDS,
REED MOULDING,
CLINCH BUTTONS



Lounsbury
Button Machine
Automatic Feed.

G. H. Lounsbury & Sons
Cincinnati, Ohio

BOLTS Rivets, Carriage Makers' Washers
and Burrs for all kinds of Vehicles
Russell, Burdsall & Ward Bolt and Nut Co.
Main Works, PORT CHESTER, N. Y. Branch at Rock Falls, Ill.

Time Has Told the Story!

Service and satisfaction always follow our rolling stock

WHEELS

ALL KINDS—BEST QUALITY

Also RIMS and SPOKES

The Eberly & Orris Mfg. Co.

MECHANICSBURG, PA.

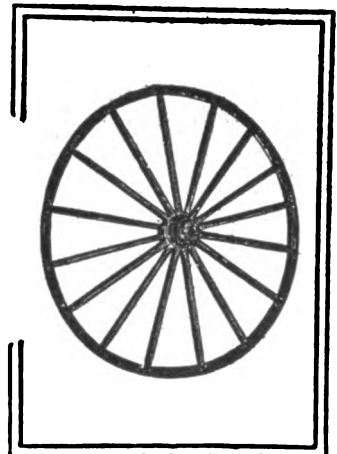

McKINNON DASH COMPANY.

TROY, OHIO.
CINCINNATI, OHIO.

ST. CATHARINES,
ONTARIO.

A

Should be used on every dash.
It will protect the top edge,
which is the first place to show
wear. :: :: :: :: :: ::

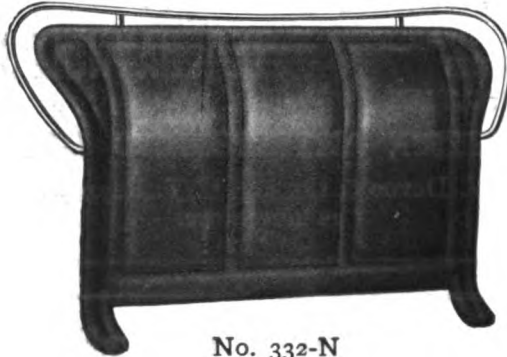

No. 332-N

A

Welded solid to the frame,
japanned, brass or nickel-plated,
adds several times the cost to
value of a vehicle. :: :: ::

Skewed Shaft Couplings

Regular or Oval Patterns
For High Arched Axles

Furnished in rights and lefts for any height of arch. Oval Axle
Clips $\frac{5}{8}$ or $\frac{3}{4}$ width to match Oval Couplings. Bolts, Clips,
Couplings, Carriage Hardware and Special Forgings

Catalogue "H" and Prices on Application.

COLUMBUS BOLT WORKS, Columbus, O.

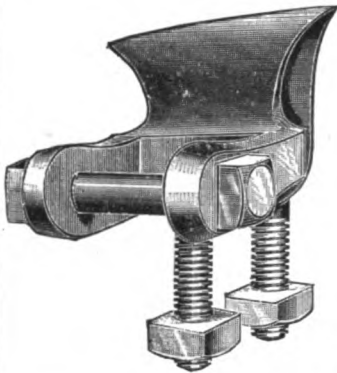

THE BRADLEY HOLD-FAST

Carriage Coupler
No. 30

If you feel that you MUST use the old
style bolt or lug shackle on the axles of
some of the carriages you manufacture,
the BRADLEY HOLD-FAST coupler
will meet every requirement.

..The HOLD-FAST is made in buggy
size only. Shaft ends and pole ends.

..While the BRADLEY BALL BEAR-
ING is the BEST carriage coupler ever
made, the HOLD-FAST is the best in
its class.

C. C. Bradley & Son.

Syracuse, N. Y.

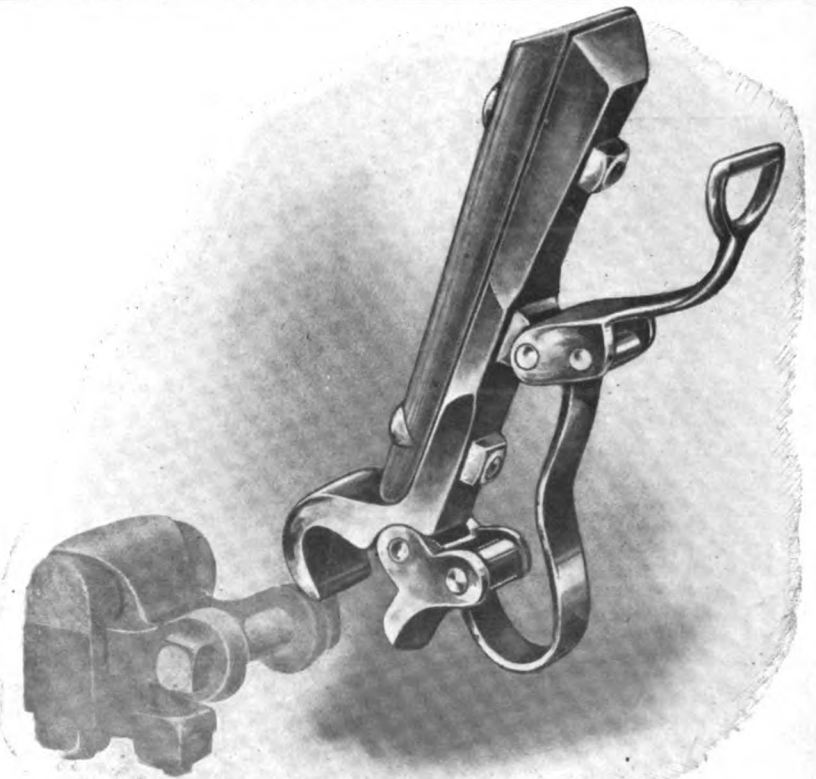

HOLD-FAST, NO. 30, SHAFT END.

The Hub

Vol. LII.

JUNE, 1910.

No. 3.

AUTOMOBILES
CARRIAGES
MOTOR TRUCKS
WAGONS



TRADE NEWS PUBLISHING COMPANY
24 - 26 Murray St., New York, N. Y.

Hoopes Bro. & Darlington Inc.

West Chester, Penna., U. S. A.

SARVEN
STAR or KENNY
Sweet Concealed Band
WOOD HUB
WARNER

HEAVY and LIGHT
for
CARRIAGES
WAGONS and
TRUCKS

IF YOU WANT THE BEST TRY OURS

The Output of Complete FRONT AND REAR AUTOMOBILE AXLES of this Plant Exceeds the Capacity of All Competition Combined.

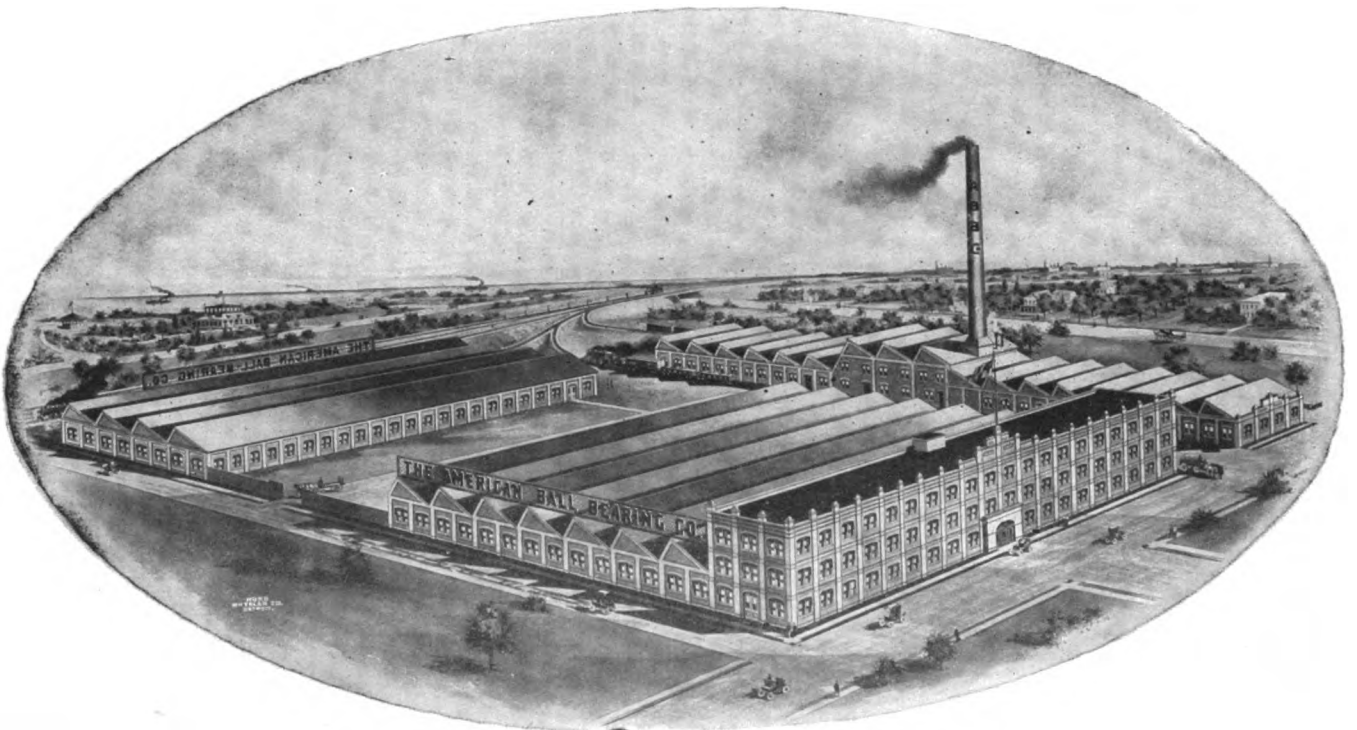

The American Ball-Bearing Co.,

L. S. & M. S. R'y and Edgewater Park.

CLEVELAND, OHIO, U. S. A.



CRANE & MACMAHON,

(INCORPORATED)

8-10 Bridge St., NEW YORK CITY, U. S. A.

Sole Manufacturers and Exporters of the

HICKORY NUT,  ACORN,  and STAR  BRANDS OF

Carriage, Wagon and Automobile Wood Stock

FACTORIES:

ST. MARYS, OHIO. RICHMOND, VA.

For Export Prices apply to the New York office.

The Lake Superior Region is the Severest in the Country on Carriage and Motor Car Varnishes.

With drenching mists from the Lake; with hot, dry winds from the plains; with mud and dust that are full of granite grits--only the best possible Varnish endures.

The vast majority of the Carriage and Motor Car Owners in that wealthy region have learned to call for *Murphy Palest Durable Body* and *Murphy Palest Motor Car Body*. These are the Varnishes that stand the racket and stay new.

Let us send you our useful booklet, "**Carriage and Motor Car Varnishes**"

Address us carefully at 236 McWhorter St., Newark, N. J.

Murphy Varnish Company, FRANKLIN MURPHY
President.

The Varnish That Lasts Longest.

NEWARK

BOSTON

CLEVELAND

ST. LOUIS

CHICAGO

Associated with Dougall Varnish Company, Limited, Montreal, Canada.

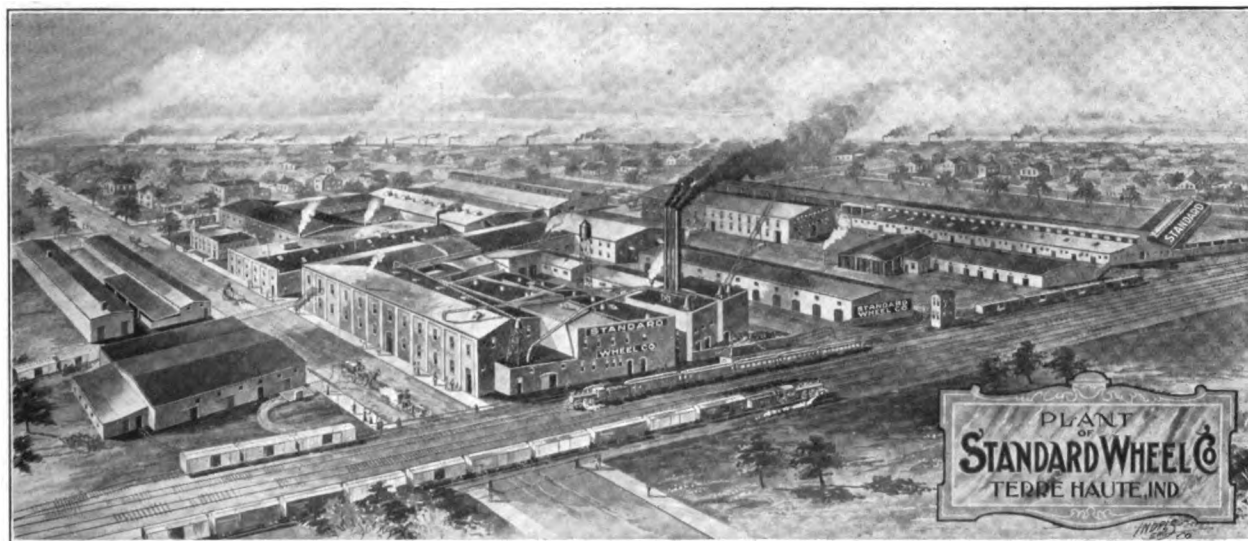

VEHICLE WHEELS AND WHEEL MATERIAL

Three Separate Departments [Light Carriage and Buggy Wheels
Heavy Express Wagon and Truck Wheels
Automobile Wheels

OUR GRADES ARE UNEXCELLED

WRITE FOR LIST.

Terre Haute, Ind.

STANDARD WHEEL CO.

Terre Haute, Ind.

JOHN W. MASURY & SON

Originators of

Superfine Coach and Automobile Colors

Acknowledged the Standard for Fifty Years

AND MANUFACTURERS OF

Fine Carriage and Automobile Varnishes

New York, Chicago, Minneapolis, Kansas City

WILLEY'S COLORS

The **RECOGNIZED STANDARD**



C. A. WILLEY CO.

COLORS GRINDERS

and Manufacturers of Specialties in

CARRIAGE, AUTOMOBILE AND CAR

PAINTS

COLORS, VARNISHES, ETC.

HUNTER'S POINT, NEW YORK CITY

THE STANDARD

Auto Door Locks

FOR NINETEEN TEN

No. 999 Security Hook Lock
for Touring Cars.

No. 25 Security Hook Lock with
complete lever control
for Touring Cars.

No. 39 Rotary Lever Lock for
Limousines and other
closed vehicles.

Test them out **NOW** for the
coming season. : : : :

English & Mersick Co.

New Haven, Conn.



VANADIUM VARNISHES

**The Bright Particular Star In The Varnish Firmament
Have You Seen It?**

Trade **VALENTIN** **ES** Mark
ARNISH

VALENTINE & COMPANY

New York Boston Chicago Toronto Paris Amsterdam

83 Years' Experience in Every Can



Edward Smith & Co.

CARRIAGE VARNISHES

Everything from the
Bare Wood to the Finishing Coat.

CHICAGO NEW YORK

THE SURPRISE IS YOURS

When You Open Your First Can of

MOORE VARNISH

Easy Working Perfect Flowing Long Lived
Highest Quality Under Every Label

BENJAMIN MOORE & COMPANY

Varnish Makers

New York Chicago Cleveland Toronto

RUB ————— RUB ————— RUB

THAT'S THE EXPERIENCE SOME PAINTERS HAVE WITH A POOR RUBBING VARNISH.
THEY RUB TILL THEIR HEART ACHES ONLY TO HAVE THE VARNISH SWEAT, OR ROLL
UP UNDER THE PAD

XX Diamond Rubbing and Hard and Quick Drying Rubbing "A"

DRY HARD TO RUB IN TWO DAYS, WITHOUT SWEATING, ARE TOUGH AND THE BEST
FOUNDATION FOR FINISHING COATS.

MADE BY **MOLLER & SCHUMANN CO.**

MARCY AND FLUSHING AVES.,

BROOKLYN, N. Y.

Please mention "The Hub" when you write.

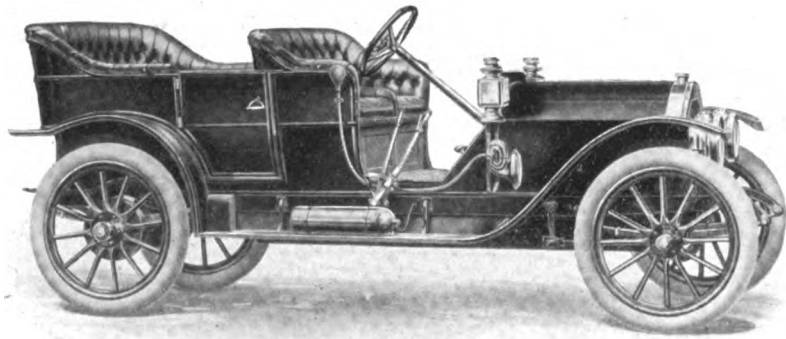

If you are to issue a catalog this Fall, why not get it from headquarters? The reputation of **The Cargill Company** for high class vehicle and auto work is unsurpassed by that of any other house in America. Write in your specifications and we will do the rest.

DESIGNING, ENGRAVING, PRINTING, BINDING UNDER ONE ROOF

The Cargill Company

Grand Rapids Engraving Company
Grand Rapids, Michigan

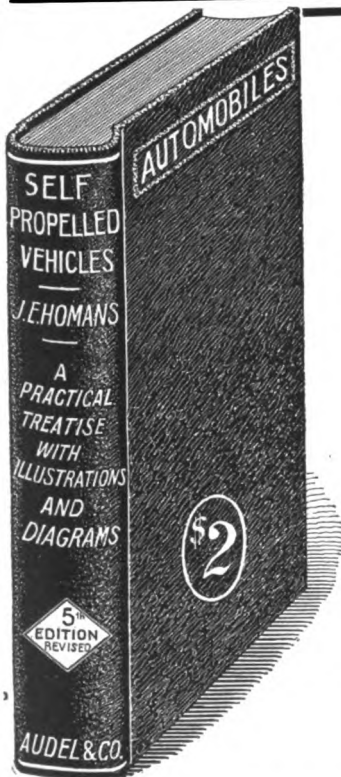

"Self-Propelled Vehicles"

Fifth Edition, Revised.

A practical treatise on the theory, construction, operation, care and management of all kinds of Automobiles.

By

JAMES E. HOMANS, A.M.

Contains 608 pages and upwards of 500 illustrations and diagrams, giving the essential details of construction and many important points on the successful operation of the various types of motor carriages driven by steam, gasoline and electricity.

This work is now the accepted standard, explaining the principles of construction and operation in a clear and helpful way. This book will be sent postpaid to any address in the United States, Mexico or Canada upon receipt of \$2.00.

Address

TRADE NEWS PUBLISHING COMPANY

24 Murray Street, New York

FOR SALE

MANUFACTURING PLANT

A complete and fully equipped plant for the manufacture of

Wheels, Spokes, Rims, Etc.

with a well established business and plenty of orders and material on hand to continue the business uninterrupted. Persons interested are requested to call or address

THE HUB,

24-26 Murray Street. New York City

Goodrich Solid Rubber Tires

Internal Wire Side-Wire Tires
Carriage Tires for Heavy Carriages

These products represent fifteen years of consistent development, and co-operation with customers. They have been distinguished always by the

Mark of Quality



Copies of the 1910 Catalogue will be gladly sent on request.

The B. F. Goodrich Company
Akron, Ohio

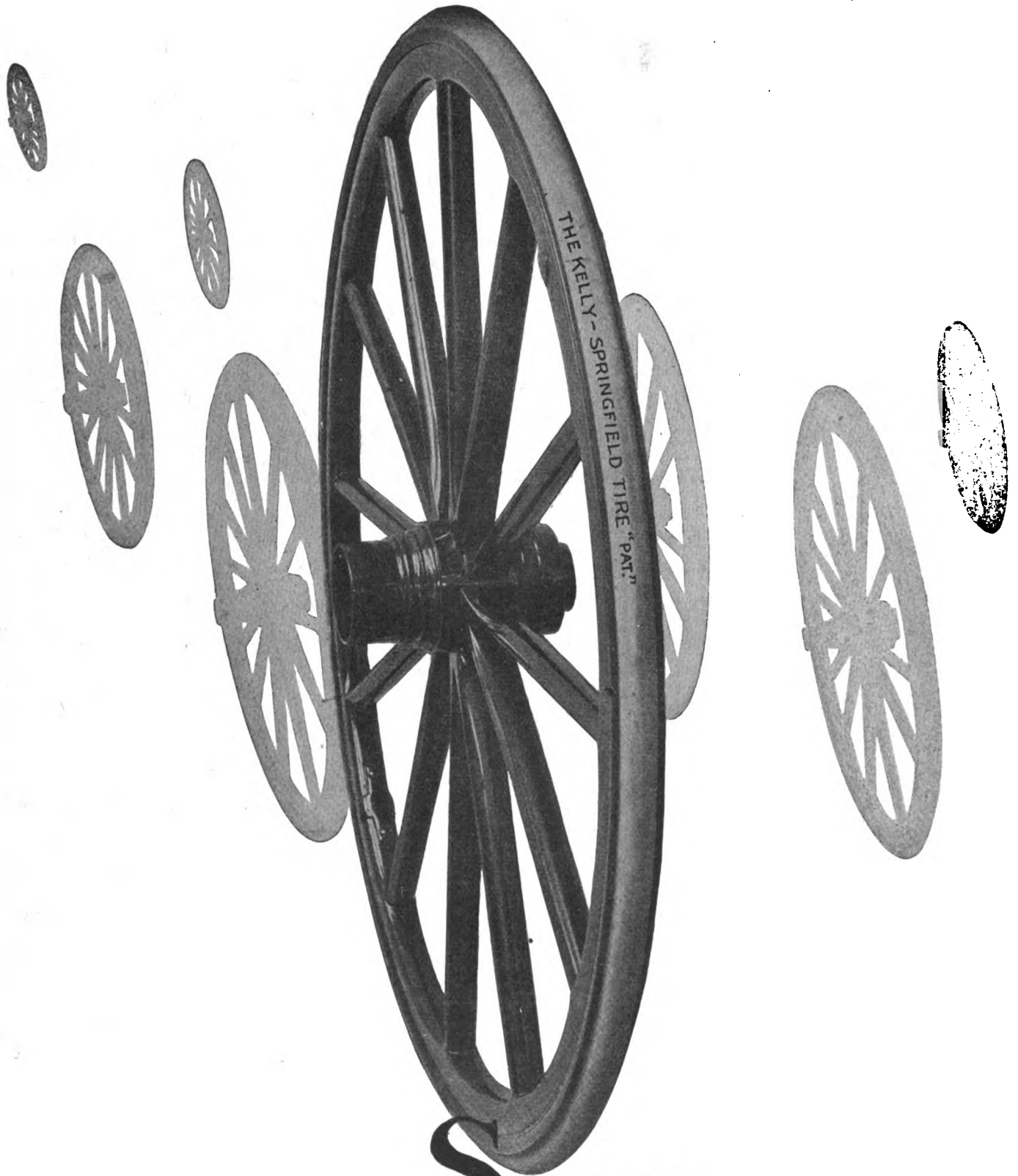

SOMEbody said that you never know how good a thing is until you see the imitation. WE say you never know how bad its imitations are until you see the
Kelly-Springfield Tire

The

Hub

Copyright, 1910, by the Trade News Publishing Co. of New York.

Entered in the New York Post Office as Second-class Matter.

Vol. LII.

JUNE, 1910.

No. 3.

THE TRADE NEWS PUBLISHING CO. OF N. Y. Publishers of THE HUB

J. H. WRIGHT, President.

G. A. TANNER, Secretary and Treasurer.

24-26 MURRAY STREET, NEW YORK.

JACOB H. KLEIN, Technical Editor.

Other Publications of Trade News Publishing Co.:

HARNESS (monthly)per year, \$1.00
AMERICAN HARNESS AND SADDLERY
DIRECTORY (annual)per copy, \$4.00

THE HUB is published monthly in the interest of employers and workmen connected with the manufacture of Carriages, Wagons, Sleighs, Automobiles and the Accessory trades, and also in the interest of Dealers.

Subscription price for the United States, Mexico, Cuba, Porto Rico, Guam the Philippines, and the Hawaiian Islands, \$2.00, Canada, \$2.50, payable strictly in advance. Single copies, 25 cents. Remittances at risk of subscriber, unless by registered letter, or by draft, check, express or post-office order, payable to the order of TRADE NEWS PUBLISHING CO.

For advertising rates, apply to the Publishers. Advertisements must be acceptable in every respect. Copy for new advertisements must be received by the 25th of the preceding month, and requests to alter or discontinue advertisements must be received before the 12th day of the preceding month to insure attention in the following number. All communications must be accompanied by the full name and address of writer.

FOREIGN REPRESENTATIVES:

FRANCE.—L. Dupont, publisher of *Le Guide des Carrossier*, 78 Rue Boissiere, Paris. Subscription price, 15 francs, postpaid.

GERMANY.—Gustave Miesen, Bohn a Rh. Subscription price, 12 marks, postpaid.

ENGLAND.—Thomas Mattison, "Floriana," Hillside Avenue, Bitterne Park, Southampton. Subscription price, 12 shillings, postpaid.

Position of Change-speed Brake Levers.

There has been some mild discussion as to the advisability of changing the position of levers so as to give free ingress to the driver's seat from the side of the car on which it is placed.

Those to whom the problem (?) was put solve it readily by stating there is no difficulty in placing the levers in the midship section of the front seat; that it is only a matter of the driver becoming proficient in the use of his left hand. Others say it is not the levers that are in the way, but the steering column.

But the real crux of the argument is stated by many when they say why make any change so long as the buyer is used to the present application of the levers and is satisfied with it. This is the utilitarian argument. It does not promote improvement, but it side-steps a lot of mechanical bother.

Some claim that any change would not avail, as the extra tire or extra wheel would still be in the way, due to its accepted position on the running board.

Some day the extra tire will not be there or anywhere, as the weight will be so much more scientifically disposed that the wheels under the car will carry the load without

carrying emergency substitutes. The levers will then be changed probably and a free access to the front seats will be a matter of course, also a narrow front body and more play for the front wheels to cramp and turn.

The argument now prevailing is that it is a waste of energy to consider such things when the buying public is used to prevailing arrangements and does not know any better.

When the iron of competition enters the soul of the builder, due to the strain of over-production, a condition now casting its shadow before, there will be a marked improvements in the body of the automobile.

Why worry when the game is coming easy?

Farm Wagons Sluggish.

There seems to be a decrease in demand for farm wagons, Nothing has taken the place of this necessary article, but it has cost somewhat more to produce it owing to advance in material prices, and dealers accustomed to distributing such vehicles seem to take the position that the trade is not profitably attractive these days.

It is also reported that users are taking better care of wagons than formerly, thus lengthening the term of service. This, of itself, if true, would diminish new sales.

Nothing has taken the place of the farm wagon, and at the price, it is one of the most economical vehicles made. The improvements in its construction constantly being added to the sum total of its proved excellence, makes of it a triumph of the art of producing high service for little money.

Federal Auto License.

Congress has under consideration a bill that should receive the approval and support of all who sell and all who use automobiles. It is known as the Federal Registration Bill (H. R. 5176) and provides for federal registration of all motor cars and protection to owners from the unjust laws of many states. Under existing conditions a motorist, though he may have been licensed by his own state to operate a car, often is held up by the police of other states through which he may tour and compelled to pay exorbitant fees for the privilege of using the roads.

A motor tourist starting from Chicago, after paying a license fee to the state of Illinois, may be stopped as soon as he reaches the Indiana line and compelled to pay another free. This may occur again when he reaches Ohio and so on. The object of the proposed law is to protect the motorist from these exactions. It does not contem-

plate any interference with the laws of the different states governing the taxing of automobiles owned by citizens of said states, nor is it proposed to nullify the speed laws as applied to all cars using the roads of the different states. The bill is designed merely to give the automobile interstate traveling rights without paying taxes in more than one state.

Studebaker Library Bulletin.

In welcoming the initial number of this weekly publication, we note a very enlightened policy on the part of the Studebaker corporation that ought to be a model for others.

So many concerns are in receipt at regular intervals of trade literature, which, owing to lack of intelligent attention, more often than not misses a useful application of contents. It is handled in the ephemeral fashion the daily news is subject to. If they could be disseminated to the various departments, and made available to mechanics, much good ought to accrue.

The Studebakers are alive to this idea. The Library Bulletin is a long step in the right direction. It ought to prove a very beneficial one to the corporation.

We take pleasure in quoting the position the house has taken as given, in part, in its Bulletin, and we wish the venture unbounded success:

"The scientific, technical, and trade magazines are counted among the forces for advancement in thought and research to-day, bringing to the people as they do, the latest and most authoritative information on subjects of interest to the working world. Naturally enough this feature of the work of the library directly appeals to all members of the company.

"The Library is receiving a strong list of magazines. As these periodicals are received in the Library they are indexed, each article being annotated so that one may know the drift of it. Then they are sent to persons in the many departments who have asked to see the current issues; or, they are filed in the Library, where they are available for all. In this way there is kept in the Library, arranged according to subject, an index of all of the important magazines received. You have but to ask for material on a desired subject and it will be sent to you. Better still, come to the Library, see where it is, what it contains, and get that for which you are searching.

"If, in looking over the periodicals sent to you, you find articles that interest you, and that you think will interest other employes of the company, will you not kindly indicate same by marking with red ink or a red pencil, giving the name of the person or department to whom it would appeal? In this way articles will be included in the magazine index you will have helped make the Library a more efficient working force."

The Dry Multiple Clutch.

The dry multiple disc clutch is receiving much attention from designers of automobile power plants.

The claim for it is that it has the advantages of the ordinary disc clutch running in oil, and that it is minus some of the disadvantages of the oil clutch.

It is not so noisy or jerky for one thing. It is not so sensitive to changes in temperature.

The subject is receiving much attention along with other refinements of the engine that make for its gradual improvement for its purpose.

Workmen's Compensation Laws.

In an address on "Workmen's Compensation Laws Relating to Bodily Injuries Received in Industrial Accidents," from the employers' standpoint, George M. Gillette, member of the Minnesota Employers' Compensation Commission, said:

"The subject of employers' liability for accidents is attracting increased attention daily in this country, as evidenced by the reference to the subject in the messages of both Presidents Roosevelt and Taft and by the legislation which has recently been proposed in many states. I am of the opinion that there is no question now before the American people pressing for solution which more vitally affects the welfare of society at large."

The Buggy Trade.

Manufacturers are reported as saying the prospects for a large season's sale of buggies were not as good since the good 1905 year.

Material is said to be difficult to procure as wanted and when wanted. Those who were optimistic as to trade this season, and contracted liberally for their supplies find themselves in the easiest position.

The vehicle output of some factories was decreased, and this accounts, probably, for the inrushing business of those who went ahead turning out their usual product.

Tendencies.

The autocars seen on the streets have made good the promise held out by the shows of longer wheel base lighter motors, wider doors, front ones inclosed. Longer springs are also favored. Magnetos have come to be the recognized best system of ignition.

NEW CLASSIFICATION RULES.

The official classification committee has placed in effect in territory east of Illinois and north of Ohio River following loading rules.

Rule D. If a shipper orders a car less than 40 feet 6 inches in length and the carrier is unable to furnish such a car, and furnishes a longer car than that ordered, but not exceeding 40 feet 6 inches in length, the minimum weight shall be that fixed for the car ordered, except than when the loading capacity of the car furnished is used, the minimum weight shall be fixed for the car furnished.

Rule E. When cars exceeding 40 feet 6 inches in length are furnished and used the minimum carload weight shall be fixed for the car furnished regardless of the length of car ordered by shipper.

MR. BONNELL MAKES A CHANGE.

Horace A. Bonnell, treasurer of the American Automobile Association, has joined forces with the Association of Licensed Automobile Manufacturers. He will act as assistant to Alfred Reeves, the general manager, taking the place made vacant by the resignation of C. F. Clarkson, who is now associated with the Society of Automobile Engineers.

Mr. Bonnell has been in the trade and industry for some time. He is one of the pioneer automobilists, and for several years was secretary of the New Jersey Automobile and Motor Club of Newark. He has been manager of the Newark show for the past three years. Largely through his efforts the Associated Automobile Clubs of New Jersey were reorganized.

Vehicle Fashions for June 1910

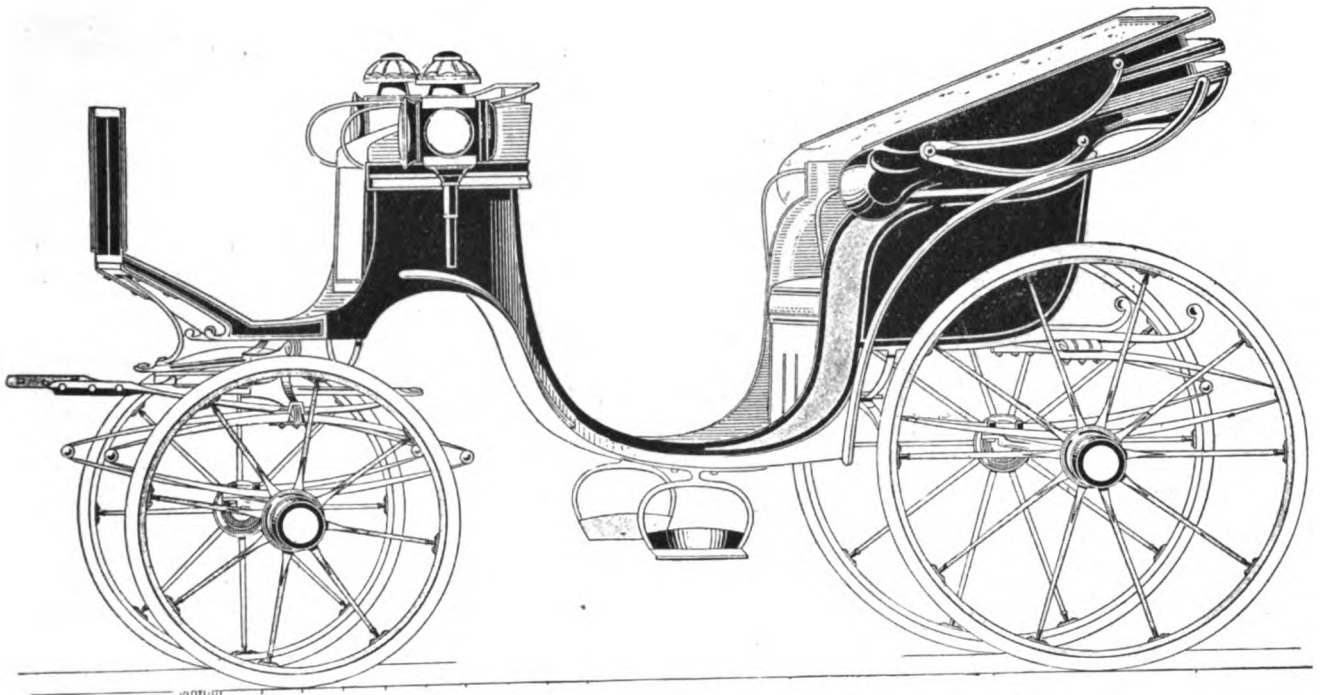

MYLORD—Built by Fussel, of Vienna.

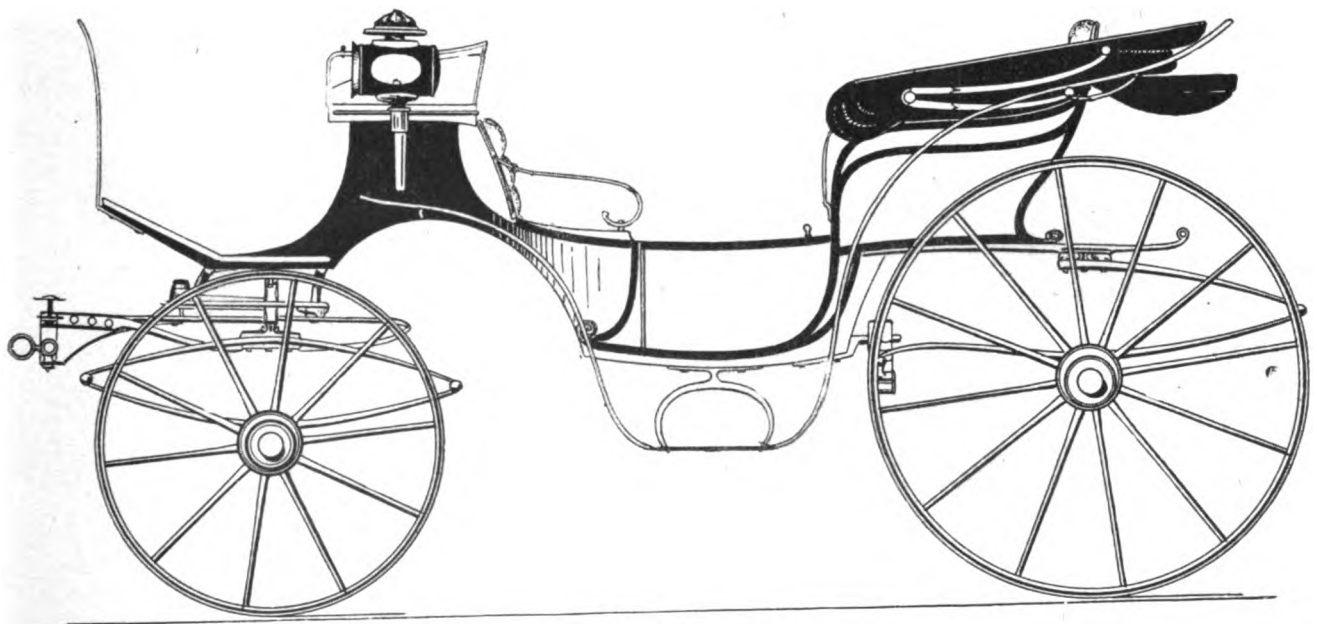

VIS-A-VIS.

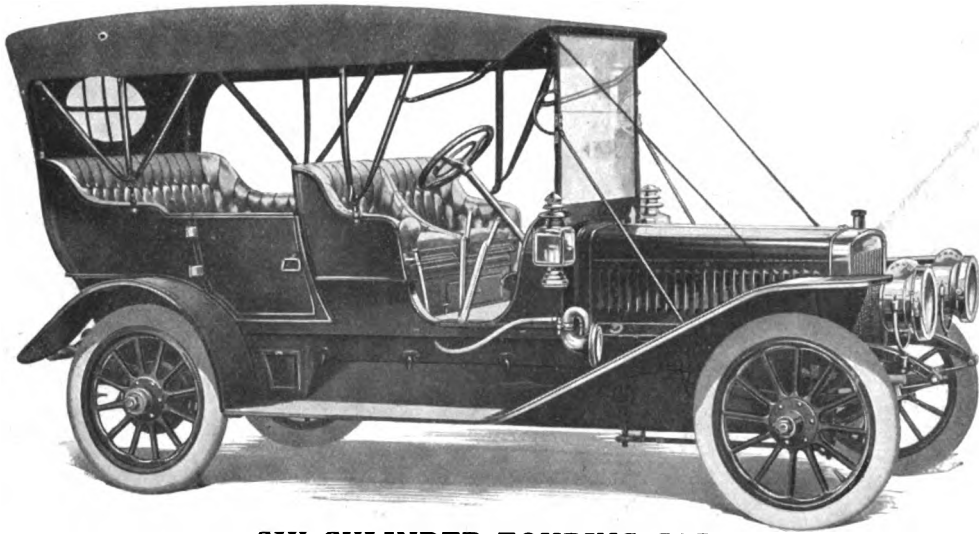

SIX CYLINDER TOURING CAR.
Built by the Winton Motor Carriage Co.



TWENTY HORSEPOWER MOTOR TRUCK.
Built by American Locomotive Company.

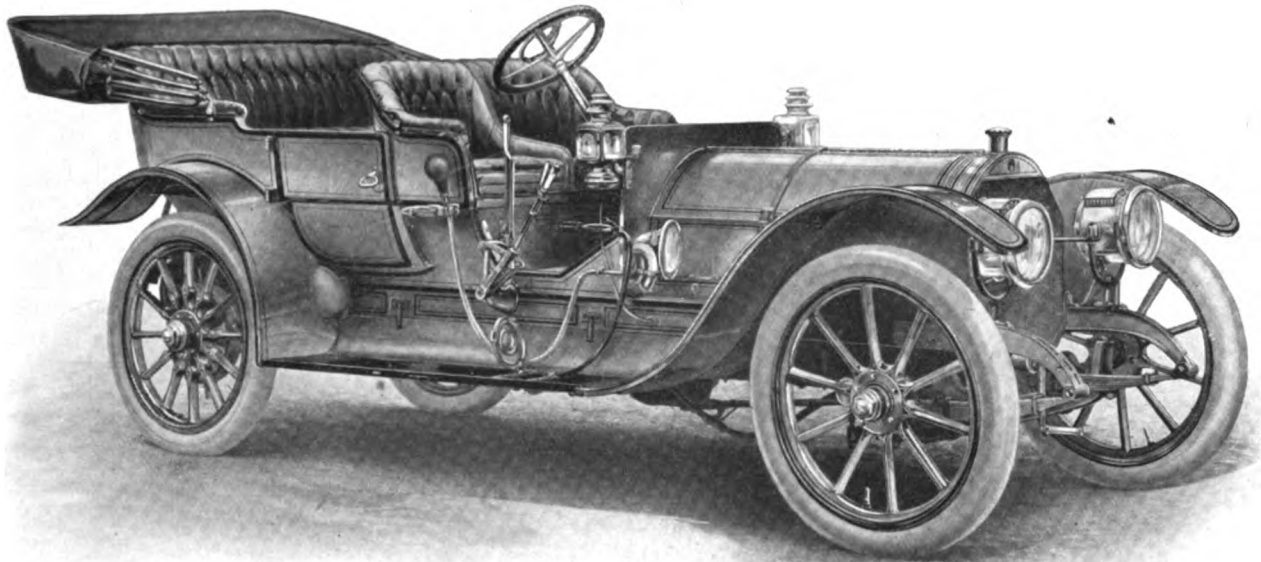

FIVE PASSENGER TOURING CAR.
Built by Matheson Automobile Company.

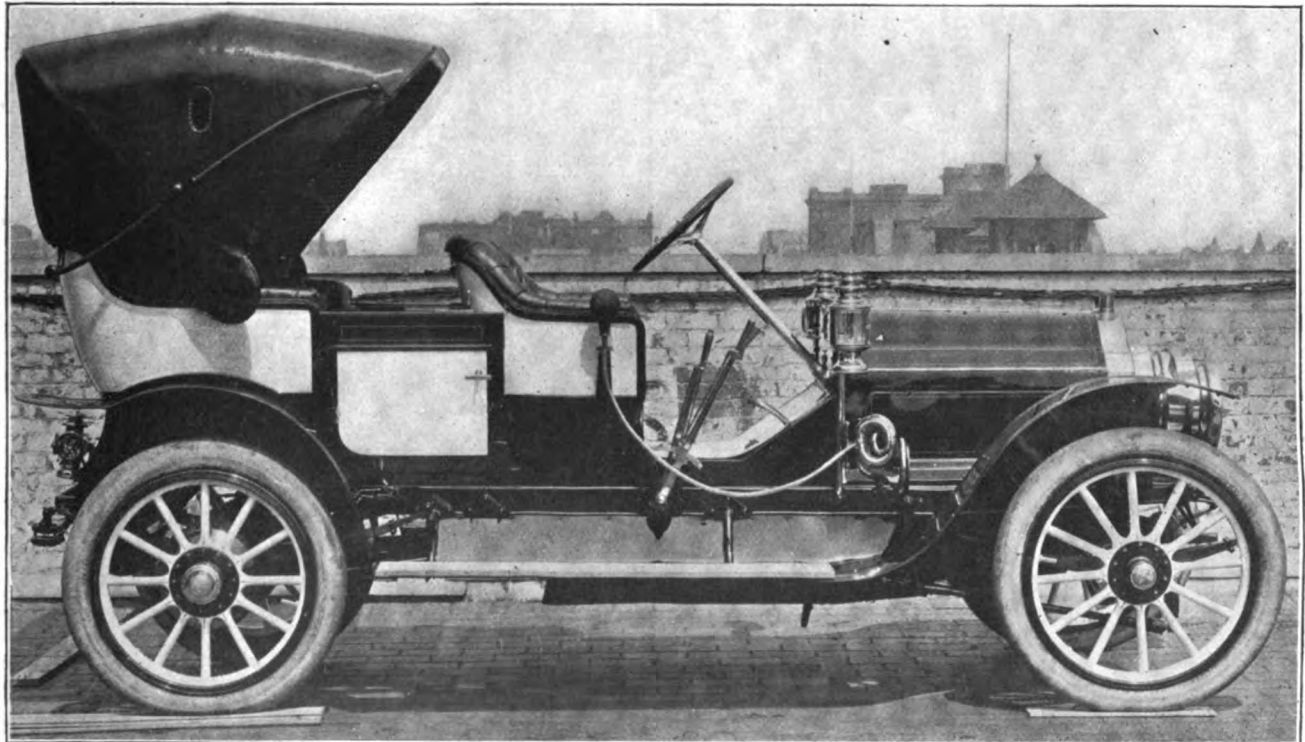

"EMPEROR WILLIAM" TOURING CAR.
Built by Studebaker Bros. Mfg. Co.

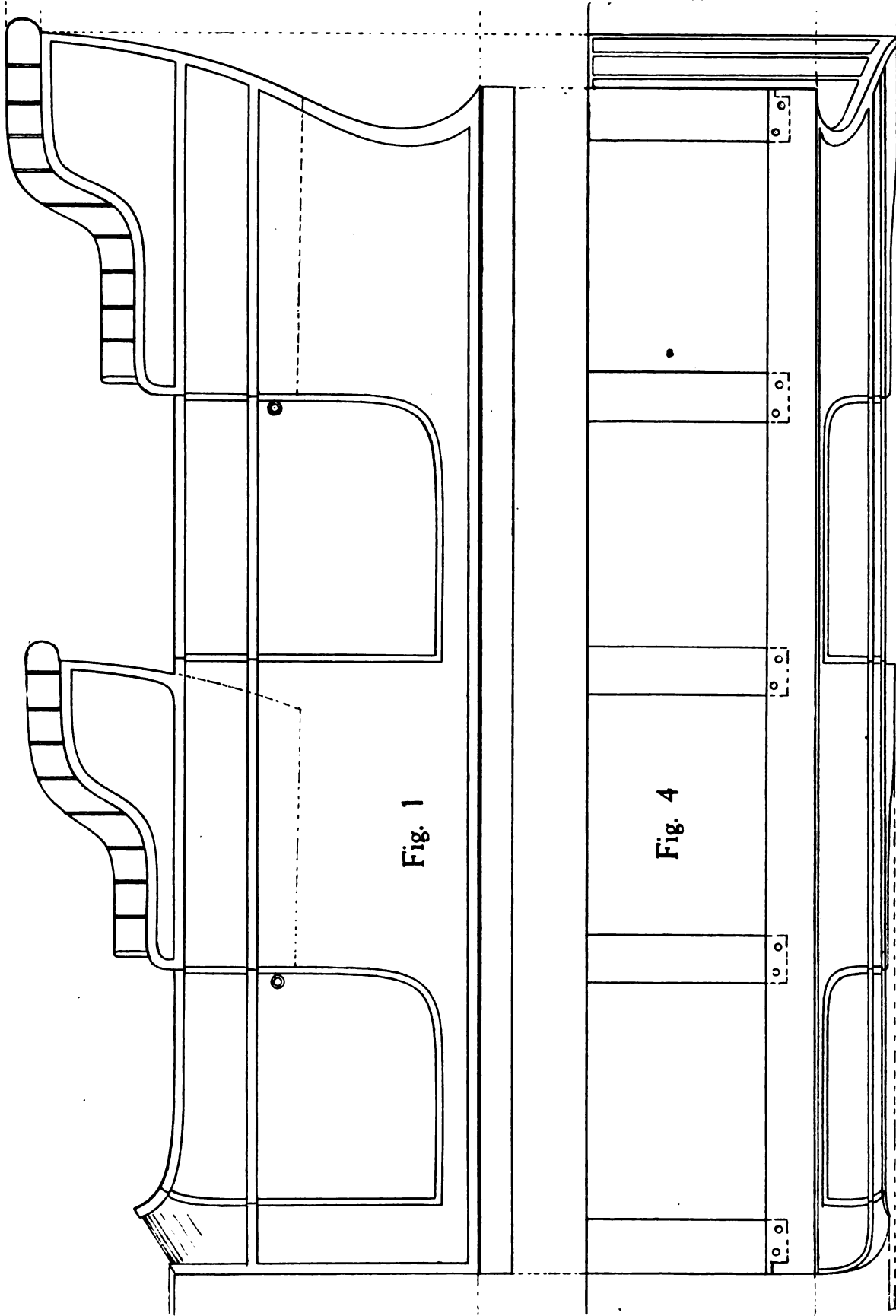

Fig. 1

Fig. 4

WORKING DRAFT OF STRAIGHT SIDED TORPEDO CAR.
(Described on Opposite Page.)

Wood-working and Smithing

WORKING DRAFT OF STRAIGHT-SIDED TORPEDO CAR.

(Drawing on Opposite Page.)

Fashion for the moment has turned its taste from the car designed in all the garbing of elaborate curving to a more sober and sombre style as portrayed in the so-called torpedo car, which is at the present moment absorbing the taste of the motor-buying public.

The points of advantage in this car are, that it is more roomy and simpler in construction, while it possesses nearly all the good points claimed for those of more intricate and elaborate outline, mud is more easily washed off, and the whole body offers a more get-at-able surface for the purposes of cleaning.

The outline of the body is plain, the elbow lines of the front and hind quarters being serpentine to give a high back rest, and elbow bearing towards the door. The doors are plain panel, on which the moulding is worked up from the solid as in high class jobs, or painted on, as in second grade work. The back cover pillar is finely ogeed, and tapered in width on the moulding strength from the bottomside to elbow line.

The body is framed and panelled throughout, and is a straight job, though there is a rich ogee turnunder given to it, which must of course be accurately worked to. The bottomside at the doorway lines may be got out to the depth shown in the elevation, and eased off on each side to the bottomside's thickness, viz, $1\frac{5}{8}$ in. This plan makes a strong bottomside to resist the bending shocks the chassis receive, and as an absorbent of vibration from them.

The doorways are strengthened with edge plating, which takes the shutting and hinge pillars, and is slotted through the bottomside across the doorway, and fixed to the bottomside on

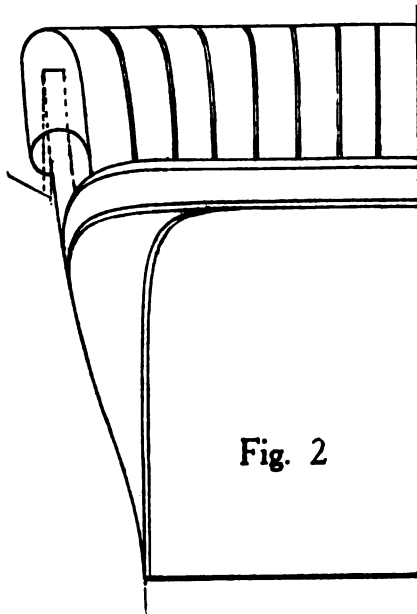

Fig. 2

the inside with $\frac{5}{6}$ in. bolts, which go through from the outside. This makes a clean and strong job of the plates fixing.

Fig. 1 gives the elevation design, which has been practically dealt with in the above resume.

Fig. 2 shows the front of body, and its side contour line, together with the design of front quarter trimming squab and elbow roll.

Fig. 3 shows the half back design, and the side contour of body. There is a good depth of body, and therefore a good

turnunder line can be gracefully drawn to connect the body's widths at top, seat line, and bottom. The mouldings are continued round the back to match the side.

Fig. 4 shows the half plan of body, which will be seen to be of very elementary construction, being straight from point to point, on the side. The cross bars are framed into the bottomside in proportionate spacing.

The design is of a lightened body carrying out this up-to-date style of car, which the torpedo racing car suggested to designers, as a likely style to capture the tastes of motorists who pre-

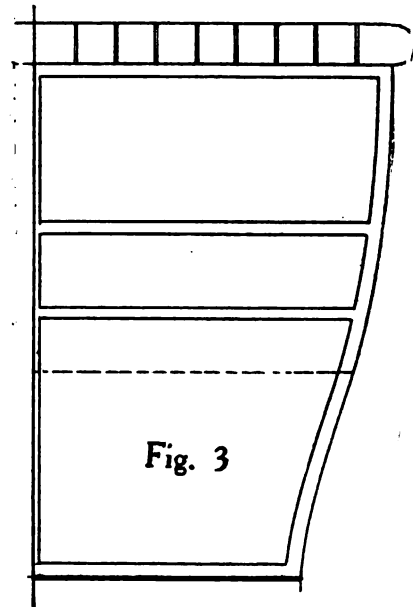

Fig. 3

fer plainness and convenience, which this design of car does, hence its popularity which in England, at any rate, is almost a craze.

The sizes are: Length of body on chassis, 8 feet $5\frac{1}{2}$ inches; depth of body side over tops of moulding, 26 inches; depth of front seat quarter from top of moulding at back, 10 in., on front of ditto, $2\frac{1}{2}$ inches. Depth of hind seat quarter at back, $11\frac{1}{2}$ inches; on front $3\frac{1}{2}$ inches over mouldings.

Width of front quarter to door, 6 inches, on the square line. Width of front body door, 20 inches; depth of ditto, 23 inches; width of front quarter on moulding line, 25 inches; space between the two doors $26\frac{1}{2}$ inches. Width of hind door $22\frac{1}{2}$ by 23 inches; width of back quarter on top moulding line $29\frac{1}{2}$ in.; full width from a continued square line from the door to the back of top of quarter, 31 inches.

Width of body on bottom, $38\frac{1}{2}$ inches; full width on top, 52 inches; on seat line 47 inches; width on top moulding line $50\frac{1}{2}$ inches; width of front seat 22 inches; width of hind ditto, 26 inches on dotted lines.

IT IS FOR SIBERIA.

Daniel Sylvester, a Flushing, N. Y., wheelwright, has just completed the construction of an immense sleigh, which is to be sent to Siberia to be used in the army service. The vehicle is ten feet long, eight feet wide, and five feet high. The runners are four and a half inches wide and eight feet long and the shoes are three inches thick. The sleigh weighs one ton and it will require the united strength of at least twelve horses to drag it.

AN ENGLISHMAN'S VIEWS.

A Britisher in this country has this to say about improvements in commercial motors:

"A company selling commercial motors should not expect to do business along the same lines as one selling automobiles for pleasure purposes. A buyer of a pleasure car is affected by fashion, feminine caprice, maybe, and does not generally or fully study running costs and in many cases the imminent drain on the depth or resources of his pocket, whereas the business man considering the purchase of motor trucks looks into the proposition from a money saving point of view. The capital outlay is not the governing influence with a buyer so much as the efficiency obtained. The cost per mile is the important figure, and

WOOD WORKING WRINKLES IN A BODY SHOP.

These illustrations are made from photographs which were taken for Wood Craft in the plant of the Wright Carriage Body Co., and are intended to show its method of handling the work.

For doing beveling or miter sawing, most saws are so arranged that it is necessary to tilt the table and then slide the stock along the inclined table, having the lower end of it resting against a fence as shown in Fig. 1. In this illustration an ordinary saw table appears as it is set up for beveling the sides of a buggy body, thus arranging for the fit of the ends.

In a case of this kind it is necessary to tilt the body or stock in the position shown, which requires considerable work on the part of the operator. Where the saw is so constructed that it

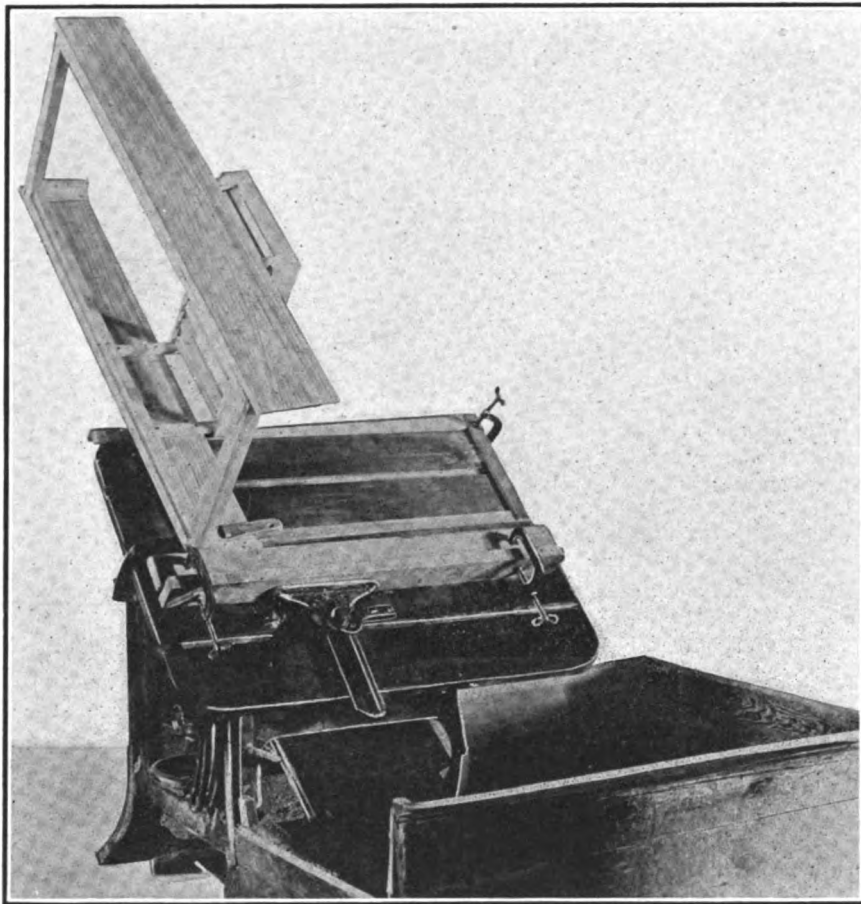

Fig. 1. Saw Table Tilted for Mitering Corners of Boxes. Courtesy of Wood Craft.

a decimal point of a cent per mile represents hundreds or perhaps thousands of dollars in a few years. A standard body may appeal to the factory output man to save him unnecessary variation of standards, but may not promote efficient service; dimensions depend on the buyers' requirements. Many trades could not utilize the engine power to assist mechanical loading and unloading, and subsidiary shafting may be conveniently fitted and much hand labor saved. Tires in relation to capital outlay and running cost are an important factor. The systematic overhaul of the truck is essential, and depreciation in such cases can be largely reduced and the efficiency in service improved. In a word, the design of the trucks, including all the details of motor construction, lubrication, etc., could be simplified so that a cheaper class of labor could be employed in their operation. It should not be necessary to demand a high-class chauffeur to operate them. Such a man is unfitted generally for truck work and the necessary cleaning, care and small repair work on the motor.

can be tilted on the arbor a considerable range of work can be done, holding the stock flat, thus lessening the labor necessary in handling the material.

For sanding piano buggy bodies a special machine has been devised, as depicted in Fig. 3. This consists of an ordinary 15-inch sanding belt passing around three drums as shown. In sanding the long sides of the body the latter is placed over the outer supports as shown and the rubbing pad, seen standing upon the inside of the belt, is pressed on the back of the sanding belt and worked back and forth, thus bringing the belt in contact with the different parts of the body.

To sand the ends of the bodies, the piece to be operated upon is dropped through the floor as shown and supported on the brackets at the center of the machine. A dust arrester hood is located at the left of the machine as seen in the half-tone. This practically removes all the dust when sanding the long side, and a large share of it when working on the end.

The V-shaped guards which are erected inside of the belt serve

to protect the belt as the man handles work into or out of the machine and also to prevent his coming in contact with the upper portion of the belt and thus serve to remove any danger of his getting caught between the belt and the drums.

STUDEBAKERS IN MINNESOTA.

With the entrance of the Studebaker Company of Minnesota into its new building at Second avenue south and Sixth street, Minneapolis, the Northwest gains as complete a vehicle repository as can be found in any part of the country. This building is one of a series that the company is erecting in several of the larger cities of the United States, though the claim is made that this one is the most complete.

The structure was erected at a cost of \$125,000. It has eight floors with basement, is 125 feet long and fifty feet wide. The

FIRST JINRICKISHAW.

Twenty years or so ago, when railways in Japan were yet few and motor cars undreamed of the common method of travel for natives and foreigners alike was the rickshaw.

Horses were scarce and of indifferent quality, the bicycle had hardly made its appearance in the Far East, so practically the only means of getting about the country away from the main line of the railway between Tokio and Hiogo was in the modified perambulator which is known all over the world as the rickshaw.

There are a number of versions of its invention and to whom credit should be given for it. The Japanese themselves claim it for a paralytic old gentleman of Kyoto, who some time before 1868, finding his palanquin uncomfortable, took to a little cart instead. The usual foreign account adopted by Mr. Black, the

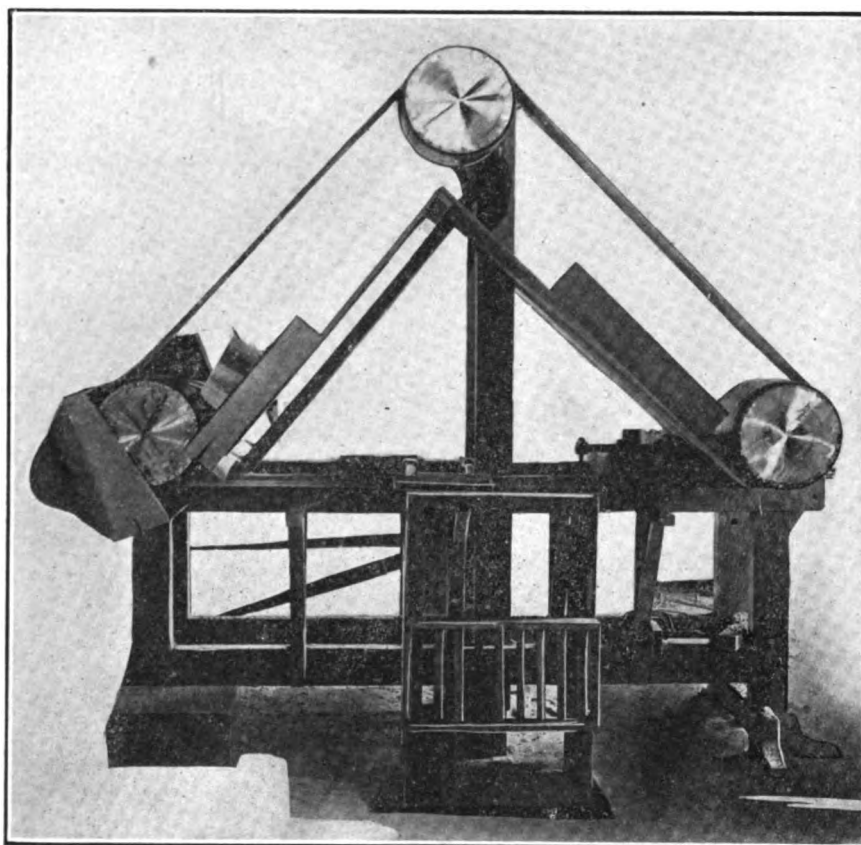

Fig. 3. Sanding Machine for Buggy Bodies. Courtesy of Wood Craft.

first two stories and the eighth are constructed of white tile, while the remainder are of red pressed brick. The frontage of the first two stories is of plate glass. The floors of these are made of idealite, a material imported from Germany and said to be the first in use in the Twin City.

The basement will be used for a storeroom, and has been installed to charge electrics. The first floor and part of the second floor will be devoted to showrooms for automobiles and light vehicles. The remainder of the second floor is used by the office. The third, fourth, fifth and sixth floors will take care of horse-drawn vehicles. The seventh floor will be an automobile storeroom, while the eighth floor will be used as a garage.

The garage will be the most fully equipped of any in the Northwest. Anything short of building a machine will be possible, and for this purpose all necessary machinery has been installed.

Clinton Schmoyer, Breinigsville, Pa., has opened a wagon repository.

author of "Young Japan," is that an American named Goble, half cobbler and half missionary, was the person to suggest the idea of a glorified go-cart somewhere about 1867.

The first official application to be allowed to manufacture rickshaws was, however, made in 1870. They were soon being turned out in hundreds and thousands for the middle class Japanese found it a cheap and comfortable way of traveling long or short distances, and there was an inexhaustible supply of men eager to turn themselves into beasts of burden in order to earn the high wages which the employment brought them. Curiously enough, though elsewhere the thing is called a rickshaw, in Japan it generally goes by the name of jinriki.

Both are abbreviations of the real word which is jin-riki-sha, meaning literally "man power vehicle," that is, a cart pulled by a man. Sometimes you hear kuruma used as an equivalent and that is a Japaning of the Chinese syllable sha. Kuruma-ya is a rickshaw puller and you would call it out in Japan when you wanted a rickshaw, just as we call "hansom" in the days when the hansom had not been driven off the ranks by the taxicab.

CRANK-AXLED CART.

Length out to out, 6 ft. 6 in.; width out to out, 4 ft. 6 in.; depth over sides and raves, 3 ft. 10 in.; main sides, 6 in. by 3 in.; two summers, 4 in. by 3 in.; front earbreadths, 4 in. by 3 in.; hind earbreadth, 4½ in. by 3 in.; middle raves, 3 in. by 3 in.; middle front rave, 3 in. by 3 in.; top raves, 3 in. by 2¼ in. deep; three standards in each side and two in the front, 2 in. by 2 in.; panels of 1 in. yellow deal; front pillars, 3 in. by 3 in.; hind pillars, 4 in. by 3 in.; bottom of 1¼ in. yellow deal; distance between bottomsides and middle rave, 1 ft. 10 in.; distance between middle rave and top rave, 1 ft. 3 in.; shafts, 4 in. by 3½ in., 8 ft. from body; braces, 2½ in. by 3 in.; shaft bar, 3 in. by 3½ in., 3

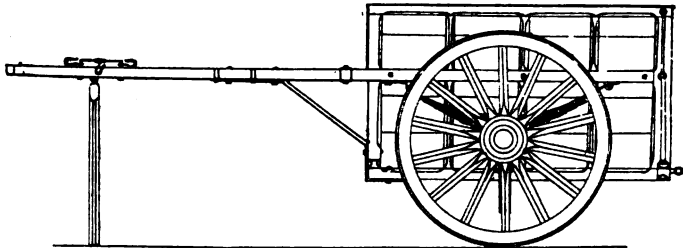

CRANK-AXLED STONE CART.

ft. from body; springs, 4 ft. 2 in. long, twelve plates, ¾ in. thick, 2½ in. wide; front scrolls, 2½ in. deep, hind ends to slide, 5 in. compass; spring block, 2 in. thick; 2½ in. (cranked) Drabble axle, cranked 18 in. from top of bed to top of flat; wheels 4 ft. 8 in. high, 12 in. oak stocks, 3 in. spokes, 3½ in. felloes, and 2½ in. by ¾ in. tires; centre of axle to outside of hind earbreadth, 3 ft. 8 in.; ridger staples in shafts, 20 in. from points; a shaft prop on each shaft, 2 ft. 9 in. long; a stout stay iron, ¾ in. diameter, from underneath shaft to front pillar, with a 2 in. by ¾ in. flap, to form corner iron on front of body; a 2 in. by ¼ in. iron plate fixed on top of rave, turned down back and front 18 in., and fixed with screws.—Auto & Carriage Builders' Journal.

OPPOSE FREIGHT RATES.

Vigorously opposing the proposed advance in freight rates, which carriers in official classification territory and western trunk line territory have decided to make, shippers from all sections of the country gathered in conference in Chicago at one of the largest meetings of shippers assembled in years.

The conference was called by W. H. Burn, vice-president of the Illinois Manufacturers' Association. Among those who addressed the conference was W. J. Evans, of the National Association of Implement and Vehicle Manufacturers.

All of the speakers declared the rates on many articles are already too high, and that the carriers are wrong in their contention that higher rates are necessary to meet increased operating expenses.

The railroads, notwithstanding protests of shippers, gave notice of the filing of advanced schedules effective June 1, but the injunction motion of the government stopped all wheels, and threw the railway men into a state of great perturbation. A committee of presidents from the roads in the Western Traffic Association, against whom the injunction was issued, have met the President by appointment, and it has been mutually agreed to let present rates alone until Congress passes the Railroad bill, if action is had this session. The President on his part, agrees to have the government's suit ordered discontinued. So matters stand unchanged as to rates, pending a truce to give legislators time to determine what they will make of the new law.

AUTOS AND IMPLEMENTS.

The trade paper founded by W. P. Nolan, under the name of the National Vehicle Magazine and later called Motor and Horse Vehicles, has appeared under the name of Autos and Implements. The office of the paper is in St. Joseph, Mich.

SHOP OBSERVATIONS.

H. C. Haner in Wood Craft tells some things he has observed where wood working machinery is in use.

Don't try to start a cylinder or sidecutter, if it is stuck in the cut, by using your hand. Ten chances to one you will lament the loss of a finger or more if you do. Perhaps an arm may go. Never try to reach any impediment after the driving belt has been pulled on.

Some things are done by men, men who are supposed to be good mechanics, that would make the doers blush to acknowledge them.

I want to say a few special words to those operators who will persist in running their machines with the feed stopped and the cutters pounding on the work in one spot for periods varying from one minute to five. It is ruinous to the keen edge of the knives and serves no useful purpose. The stops can be set up to the work with greater safety and more accuracy when the machine is stopped. The time taken to stop and start is more than made up on the easy and safe handling.

I have had a man ask me "How can a knife strike on a place that it has cut out?" Well, I cannot dispute the theoretical fact that what has been removed, i.e., cutout, is not there, but I do know for a certainty the practical fact that a knife will pound its edge off if allowed to run on one spot any length of time.

SPRING SUSPENSION OF GERMAN TRUCK.

The illustration of the spring linkage of the Bussing truck, which appears below, is reproduced from the Zeitschrift des Mitteleuropaischen Motorwagen-Vereins, which recently published an instructive article on the steering and suspension of this car.

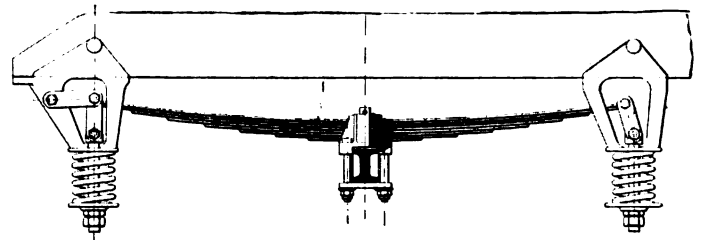

The construction shown is used on the front springs only, for the protection of the motor and radiator, in the case of trucks, but is also used on the rear springs for omnibuses. The drawing is self-explanatory in so far as regards the design and operation.

MUTUAL BENEFIT.

A mutual benefit association is being formed by the employes of the Freeport Carriage Co.—a subsidiary concern of the Moline Plow Co., at Freeport, Ill., and at a preliminary meeting John Bonn was elected temporary chairman. The association, which provides for a remuneration in case of illness, is the first of its kind to be formed in the Freeport factories. It is very similar to the Employes' Aid Association of the local factories.

While the association is not yet fully organized, present plans are for a 25-cent initiation fee and 10 cents a week dues. In case of illness an employe will receive \$5 a week and in case of death his relatives will receive \$75 for burial expenses.

TAXIS EVERYWHERE.

The president of the new Cambridge (Mass.) Taxicab Company is Stephen J. Moran, the well known carriage manufacturer. The treasurer and manager is William P. Barnhart, of Boston. The company is capitalized for \$25,000 and the organization of this corporation is said to be the first move on the part of Boston capitalists to operate small companies of a similar nature in the towns around Boston, and eventually throughout Massachusetts and other points in New England.

Carriage and Automobile Painting

THE MAKER ON VARNISH FAULTS.

A varnish maker has issued a manual for painters in which all the troubles laid at the door of varnish are commented upon. Let us see what they are from the viewpoint of the man who makes this glistening product:

Blooming. When a varnished surface blooms, that is, assumes a misty or foggy appearance, you can be reasonably sure that there is too much dampness in the room, or that it is poorly ventilated. The best way to repair this imperfection is to rub the surface with crude oil and water, using ordinary waste, first dipped in water, then in oil. The purpose of the water is to clean the surface, whereas the oil should bring back the luster.

Crawling. A sudden change of temperature during the process of drying sometimes causes the varnish to crawl up in ridges, or show furrows. Crawling is also apt to take place when the varnish is applied over a cold surface, or over undercoatings insufficiently dry. If proper precautions are taken, of course, this defect should never occur. To remedy it, the varnish must be sanded down, or removed, and the surface re-varnished.

Sweating. A rubbed finish sometimes turns back to gloss during the humid summer months, and is then said to have sweated. This occurs, however, in the case of a good hard-drying varnish only when the rubbing was done before the varnish was sufficiently hardened. Sometimes this fault may be overcome by re-rubbing, but if you have used a varnish that will never dry very hard, you must re-finish with a hard-drying varnish over the old surface. This can then be rubbed to a dull finish.

Flattening. There are several possible explanations for the deadening or flattening of a finishing coat. If the under coats are not thoroughly dry, they will absorb the finishing coat and cause this deadening. Improper filling on unseasoned lumber, or graining compounds, produce the same result. Another coat of varnish will give the desired finish, if you are sure the under coats are dry and the conditions are favorable.

Cracking. Varnish cracking, when not caused by an inferior varnish, comes from the application of too heavy coats, or may also be due to the lack of precaution in observing whether the undercoats were sufficiently dry. When the varnish cracks, it must be sanded down or removed, and the work done over.

Pitting. Pitting, or little pock marks, may appear on the varnished surface, if it suffers a sudden change of temperature, or a draft strikes it while drying, or if proper ventilation is lacking. A damp surface under the finishing coats has a tendency to bring about this condition. A pitted surface cannot be re-varnished, as the defect cannot be rubbed out.

Checking. The cause for varnish checking, or exhibiting numerous small cracks, is usually to be found in the fact that the surface has been exposed to sudden cold, or, that a coat of short oil varnish has been put over that of an elastic one. Sometimes checking is caused by very heavy finishing coats. When used over graining color, a varnish may check; due to the graining color not being thoroughly dry. There is no way to repair the damage except by removing the varnish and refinishing.

Blistering. When a varnished surface is exposed to the sun or heat while drying, a film quickly forms over the surface, and the turpentine in the soft varnish underneath forms gases which have no chance to escape, and cause this blisters. Sometimes blistering is due to the existence of dampness or sap in the wood, or dampness in the undercoating. A blistered surface may be sanded down and given an additional coat of varnish,

if not too badly blistered. If the varnish coats are blistered from the bottom up, the job must be done over entirely.

Chilling. Complaints are frequently made to the manufacturers during cold weather that varnish has become specky, and is therefore useless. This peculiarity, however, indicates no deficiency in the varnish itself, but is the natural result of continued exposure to the cold, and the varnish has become what is known as "chilled." These specks have the appearance of undissolved gum particles, but are in reality due to the congealing of the oil. Varnish should never be applied when in this condition, or when chilled at all, but should be kept in a warm place, near a stove or a steam pipe, until brought back to the natural condition. This process may be hastened by placing the can in hot water.

TRANSPARENT FILLING.

This is sometimes desirable yet difficult of achievement because the oil or other fluids used in the filling discolor the wood more or less, even when the filler is comparatively colorless. A new German process would seem to solve this problem. It undertakes to fill the pores of the wood with a transparent material which will prevent oil from striking through. First the wood is rubbed with oil, either raw linseed or polishing oil, then the superfluous oil is wiped off with a piece of soft paper wet with alcohol. Now the surface is ready for a coating of shellac, purified and clarified by filtration, this being sprayed on, using an atomizer. Then it is polished with a solution of celluloid in alcohol, rubbing with a regular pad. The pad parts with its liquid which is then pressed into the pores of the wood; this celluloid solution dissolves the shellac in the pores of the wood and attaches itself firmly to the walls of the pores; it is of course perfectly transparent. This filling is also very elastic, on account of the celluloid, and it is said to become perfectly incorporated with any subsequent finish that may be placed up it.

The usual method of filling wood calls for mineral filling material, silica being commonly employed though whiting and silver white also are used. The only possible objection to a mineral filler is that it will show up in the pores of the wood, more or less. Silica does not do this to any great extent, yet it does it a little.

A mineral substance penetrates both the coarse and fine fibers of the wood, and, being opaque and of a different color from the wood, and the polishing coat which follows, both the color and the grain. Again, it is pointed out that while the mineral fillers are greedy of oil they do not hold the oil permanently, so that, while the oil in the polishing is taken in by the pores, it comes out of them later, under the influences of temperature. This is worth thinking about.

POLISHING.

We have noticed that some touring bodies turned out by builders have discarded a varnished surface in favor of an oil polished surface, advancing the contention that such a surface is more easily freed from dust, does not retain marks due to placing the hands on bright surfaces, and can be kept looking better for a longer time. We give, following, a polishing method that is in vogue among furniture makers that may have value in the paint shop:

There are two processes of polishing that may be described here. By the quick method we take a handful of raw cotton and dip it in a mixture of equal parts of sweet oil and alcohol, rubbing the surface of the work with this in a circular manner. Af-

ter a time the polish begins to show. By the slow process we first bring the work to a perfect level by rubbing, then flow on a coat of flowing varnish, and when ready for rubbing rub it in with FF pumice stone power, after which clean up. Rottenstone powder maybe used in the rubbing, using a chamois and rubbing in a circular way. The rottenstone powder is always a good thing after the rubbing with pumicestone because it will rub out any scratches made by the pumice stone powder. Allow the rottenstone to dry on the work, then rub this off with the palm of the hand in a rotary manner, wiping the hand every time it passes over the work.

ARTIFICIAL SHELLAC FINISH.

While not nearly so costly as it once was, owing to the denaturing of grain alcohol, yet for some purposes it is too closely to use where its use would be very desirable.

Here is a formula made with an artificial gum to be had in the New York market:

It is a hard gum and like shellac dissolves readily in the usual solents. It can be mixed with rosin and gives as a result a most beautiful lacquer or orange alcohol varnish imitation. The formula is thus: Shellac, 100 pounds; French artificial kauri, 50 pounds; common rosin, 50 pounds; camphor gum, 1 oz.; acetone, 5 gals.; and wood alcohol, 30 gals.

It is difficult to get the true color of orange shellac in an imitation shellac and there is only one substance that has been found to do this. That is aurine. One ounce of the tincture of aurine will color one gallon of the shellac. It is dissolved in either wood or grain alcohol. The gums and liquids named are placed in a mixer and revolved until perfect dissolution ensues. It would not pay to make this as the ready-or-use article may be bought cheap enough.

PURE PAINT LAW.

The Hepburn bill has been reported to the Senate, after having been discussed in subcommittee by the interest for and against.

The Secretary of Agriculture is empowered to enforce the act, and the Bureau of Chemistry the duty of examinations. Sections 6, 7 and 8 make these important rulings:

Section 7. That for the purpose of this act an article shall be deemed to be adulterated.

(a) If any material contained in the article be of inferior quality to that claimed on label.

(b) If any substance has been substituted in whole or in part for any ingredient claimed to be present.

Section 8. That there shall be shown clearly and distinctly upon the face of the label and in the English language—

(a) The name and residence of the manufacturer of the paint, or of the distributor thereof or of the party for whom the same is manufactured.

(b) There shall be shown the true net weight and the true measure in gallons or parts thereof.

(c) There shall be shown, with substantial accuracy, the percentage and quantity of white lead, zinc, oil or spirits of turpentine, if any, of each ingredient, both solid and liquid, contained therein.

That, for the purpose of this act an article shall also be deemed to be improperly labeled or misbranded.

First. If it be an imitation of or offered for sale under the name of another article.

Second. If the contents of the package, as originally put up, shall have been removed, in whole or in part, and other contents shall have been placed in such package, or if the package fails to bear statement on the label of the quantity or proportion of white lead, zinc, oil or pure spirits of turpentine, if any, contained therein.

Third. If in package form and the contents thereof, of white lead, zinc, oil or spirits of turpentine, if any, are not stated

plainly and correctly in terms of net weight or measure on the outside of the package.

Fourth. If the package containing it or its label shall bear any statement, design, or device regarding the ingredients, or the substances contained therein, which statement, design, or device shall be false or misleading in any particular.

COMPOSITION OF PUTTY.

Putty is a painter's material, regarding which there is much complaint. You can buy from your supply house pure linseed oil and whitening putty, but it should be remembered that a gallon of 60-cent linseed oil still costs 60 cents after it is ground with whitening. There is no chemical change in this combination that will reduce the price of oil or increase its volume.

If for your own amusement you want to know what modern cheap, commercial putty is made of, you can proceed according to the plan outlined for paints in oil. Extract the oil with benzine and save the first washing for further examination. Examine the dried solid matter with a hand-glass to see whether it is whitening or marble dust or a mixture. Then treat some of it in a test tube with dilute hydrochloric acid. All the carbonate of calcium will dissolve with effervescence. Anything that remains undissolved is probably silica barytes or clay, and for practical purposes it doesn't matter which.

GLUE.

Glue-room practice as carried on in the Steinway piano factory. The glue used is a pure hide product. Each sample which is received undergoes careful examination, the following tests being made: One sample is weighed and dried to constant weight at 180 degrees Fahr. in an air bath to determine the contained moisture. Another sample is weighed out and soaked in water for 48 hours to determine its capacity for absorption. A third sample is burned to ash and the ash inspected definitely to determine whether it was hide or bone glue. No. 4 specimen is soaked and made into glue of the standard consistency and then tested with a viscosimeter to ascertain whether it conforms to the standard requirements in this line. In addition to this, standard gluing tests are made by gluing up samples which are subsequently broken apart to accurately show cohesive capacity of the glue.

After a shipment of glue has been accepted it is sent to a small building where all of the glue for the works is prepared. A standard amount of water is added, the glue soaked, heated to 180 degrees, and poured out into flat cakes. These cakes are then allowed to harden and the material sent to the various departments in this form. Every workman has his own glue pot. He applies to the foreman for sufficient glue to do a given amount of work. This is cut from the cake, put in the pot, and heated.

Experience has shown that for some of the work more water must be added to the glue than that originally supplied, and the control of this addition is left in the hands of the workman, but provision is made to insure the fact that no sample of glue is heated above 180 degrees. Every night each workman cleans out his glue pot and this waste is never used for gluing together the material entering into the construction of pianos. The cleanings from the pots and the glue collected from the zinc plates beneath the glue presses is sold to the makers and used by them for making wallpaper size.—Wood Craft.

BROODING, THEN MURDER.

As the result of an altercation at Morgantown, W. Va., between two employes at Lough's carriage factory, Robert Hessen, 35 years old, a carriage painter, was shot twice, once through the abdomen, and once through the heart, dying within a few minutes, and Edward Stewart, aged 65, a carriage trimmer, is in the lock-up. The victim leaves his widow and two children.

REPAIR PRICES CURRENT IN ST. LOUIS.

AUTOMOBILES.

| | |
|-------------------------------------------------------|--------------------|
| Limousine color and varnish body chassis.. | \$ 75.00 |
| “ Repaint complete | \$100.00 to 125.00 |
| Touring car, color and varnish body and chassis | 60 00 |
| “ Repaint complete | 75 00 to 100 00 |
| Tourabout, color and varnish complete | 50 00 |
| “ Repaint complete | 65 00 to 75 00 |
| Runabout, color and varnish complete..... | 25 00 |
| “ Repaint complete | 35 00 to 50 00 |
| Delivery Auto Repaint Paneled | 45 00 to 60 00 |

TRIMMINGS.

| | |
|---------------------------------------------|----------------|
| Recover cape top according to material..... | 75 00 to 95 00 |
| New dust cover | 12 00 to 15 00 |
| “ Front curtains | 15 00 to 18 00 |
| “ Dividing curtains | 15 00 to 20 00 |
| “ Rubber on running boards | 10 00 to 12 00 |
| “ Front mat | 6 00 to 8 00 |
| “ Bow in top | 10 00 to 12 00 |

WOODWORK

| | |
|-------------------------------------------|------------------|
| New Spokes, front wheels | \$0 75 to \$1 00 |
| “ hind wheels | 1 00 to 1 25 |
| Half rims on wheels, each | 2 00 to 2 50 |
| Reset Channels, each | 1 75 to 2 25 |
| All panel work, see carriage list. | |
| “ other trimming work, see carriage list. | |
| “ “ work, smith and helper | \$1 50 per hour |
| “ “ woodwork | 75 per hour |
| “ “ touch up, at | 75 per hour |
| “ “ trimming work, at | 75 per hour |

STORM BUGGIES.

| | |
|-----------------------|----------------------|
| First class job | \$225 00 to \$275 00 |
|-----------------------|----------------------|

WOODWORK—STORM WAGONS.

| | |
|---------------------------------------------------------------------------------------------------|---------|
| Storm Buggy Body with seat, complete, replacing irons and trimmings, and painting new parts | \$76 00 |
| “ Buggy Body, without seat, replacing irons and trimmings, and painting same | 33 00 |
| New Side Panel to Storm Wagon, Body and painting | 6 00 |
| “ Back Panel to Storm Wagon Body and Painting | 4 00 |
| “ Front Panel with Corner Pillars to Storm Wagon and Painting | 3 50 |
| One New Back Pillar to Storm Wagon and Painting | 4 50 |
| “ New Side Sill to Storm Wagon and Side Panel Painting | 4 00 |
| New Bottom Boards on Storm Wagon Body and Replacing Body Loop | 3 00 |
| One New Side Seat Panel to Storm Wagon Body, replace trimming and painting | 6 75 |
| “ New Back Seat Panel to Storm Wagon Body, Replace Trimming and painting | 12 00 |
| New Seat Frame to Storm Wagon Body, Replacing Irons and Painting | 3 25 |
| New Top Frame to Storm Wagon (without pillars), canvas and replace irons and trimmings | 12 00 |
| One New Side Rail to Storm Wagon Top, Replacing irons and trimmings ... | 4 50 |
| “ New Front Rail to Storm Wagon Top, Replacing irons and trimmings | 2 75 |
| “ New Bow to Storm Wagon Top, Replace trimmings | 2 00 |
| “ New Lid to Seat of Storm Wagon Body | 1 00 |

REPAIRS—STORM BUGGY WHEELS.

| | |
|-----------------------------------------------------------------------|-------|
| New Set No. 7 B Grade Patent Wheels, Replacing Flat Steel Tires | 25 00 |
|-----------------------------------------------------------------------|-------|

| | |
|--------------------------------------------------------------------------------|---------------|
| One Only No. 7 B Grade Patent Wheel, Replacing Flat Steel Tire | 7 50 |
| New Set No. 2 Grade Band Hub Wheels, Replacing Flat Steel Tires | 27 50 |
| One Only No. 2 Grade Band Hub Wheel, Replacing Flat Steel Tire | 8 00 |
| New Set No. 7 B Grade Patent Wheels and New Flat Steel Tires | 30 00 |
| One Only No. 7 Grade Patent Wheel and New Flat Steel Tire | 8 50 |
| New Set No. 2 Grade Band Hub Wheel and New Flat Steel Tires | 32 50 |
| One Only No. 2 Grade Band Hub Wheel and New Flat Steel Tire | 9 00 |
| New Set No. 7 B Grade Patent Wheel, Replacing Channels and Rubber Tires .. | 31 00 |
| One Only No. 7 B Grade Patent Wheel Replacing Channel and Rubber Tire .. | 9 00 |
| New Set No. 2 Grade Band Hub Wheels, Replacing Channel and Rubber Tire .. | 33 50 |
| One Only No. 2 Grade Band Hub Wheel, Replacing Channel and Rubber Tire .. | 9 50 |
| New Set No. 7 B Grade Patent Wheel New 1 1/8 Channel and Rubber Tires ... | 49 00 |
| One Only No. 7 B Grade Patent Wheel, New 1 1/8 Channel and Rubber Tire | 12 50 |
| New Set No. 2 Grade Band Hub Wheels, New 1 1/8 Channels and Rubber Tires | 51 50 |
| One Only No. 2 Grade Band Hub Wheel, New 1 1/8 Channel and Rubber Tire | 13 50 |
| New Spokes in Patent or Band Hub Wheels, Each Painted | 35 to 40 |
| Half Rim to Patent or Band Hub Wheel, Each Painted | 1 25 to 1 50 |
| One New Hub on Band Hub Wheel, Re-driving Spokes and Replace Rim... | 8 00 to 10 00 |
| Resetting Box in Hub to Straighten Wheel, Each | 50 |

WOODWORK—STORM WAGONS, GEAR AND SHAFTS.

| | |
|---------------------------------------------------------------------------|----------------|
| One New Axle Bed, Replacing Irons, Painting .. | 3 00 |
| Two New Brewster Reaches, Replacing Irons and Painting | 5 50 |
| One New Brewster Reach, Replacing Irons and Painting | 4 00 |
| New Head Block, Replacing Irons and Painting .. | 2 70 |
| New Spring Bar with Scroll Ends, Replacing Irons and Painting | 2 50 |
| All New Shafts Complete, Replacing Irons and Trimmings and Painting | 14 00 to 16 00 |
| One New Shaft, Replacing Irons and Trimmings and Painting | 3 00 to 3 75 |
| New Shaft Bar, Replacing Irons and Painting .. | 1 50 to 2 25 |
| New Singletree, Replacing Plates, Trimming and Painting | 1 25 to 1 75 |

NEW CLUB HOUSE.

Invitations have been sent to all St. Louis carriage and wagon makers to attend the formal opening of the new building recently erected by the St. Louis Carriage and Wagon Builders' Club, southeast corner of Broadway and Elm streets. There will be talks on subjects of interest to the carriage and wagon builders.

MAIL WAGON FOR THE COAST.

The Hoover Wagon Works, York, Pa., has recently booked an order for 22 screen mail wagons for the federal government, for delivery to the Pacific coast. The wagons will be used in the United States mail service in the cities of Los Angeles and San Francisco.

THE FACTS AS TO TIMBER.

The industries which use wood mainly in manufacture represent an investment of twenty-two hundred and fifty millions of dollars. The product from this is about three thousand millions yearly.

The forests from which supplies are had now cover five hundred and fifty millions of acres, but this is a reduction from eight hundred and fifty.

Of the five large forest divisions, the Central forest produces nearly all the hardwoods, such as elm, hickory, gum, ash, etc. This area was about two hundred and eighty millions of acres, yielding some fourteen hundred billion feet.

All that remains of forests of all woods is forty-five per cent. The central forest we spoke of maintains forty-six per cent.

It is a promise for the future that no native tree has yet become entirely extinct, but the commercial supply has become much reduced.

The distribution of forest land puts the bulk of the publicly owned tracts in the West, in the shape of National forests, parks, etc. These now contain over one hundred million acres of merchantable timber.

The yearly growth of wood does not average more than twelve cubic feet per acre, yielding an annual growth of seven thousand million cubic feet. In Europe, where the growth is slower, better methods have caused better yields in cubic feet. Our trees grow faster, but our methods get less stock. We cull from our timber supply yearly twenty thousand million cubic feet.

The center of supply is constantly shifting and these changes are interesting to note. In 1880 Michigan gave 23 per cent. of the total, but in 1907 it had fallen to 4.5 per cent. On the other hand the figures just reversed in Washington, being 1 per cent in 1880, and over 9 per cent in 1907. This gives a fair idea of the shifting scene.

The waste is deplorable. Forest fires consume millions of acres, and the worst feature is the young growth that is destroyed. Replanting will have to be resorted to over vast areas, owing to total young growth destruction. A still more serious agent of destruction is the damage to future timber supply by the almost universal damage in logging, unnecessary, and due to carelessness.

We export and import wood, but we export fifteen hundred million feet more than we import, and this equals a total decrease of the supply of about 1 per cent, which stands for the yearly forest drain. As no other country is or can be in position to meet our needs, this represents positive, irreparable loss.

The records prove that, others factors remaining constant, industrial progress is accompanied by increased consumption of wood. This fact is so universally manifest that it can not be thought an accident. It may be regarded as a law of industrial life.

It might be supposed that the substitution of other materials for wood, which takes place with industrial progress, would decrease the per capita need of wood, but such is not the fact. Substitutions may diminish consumption for specific purposes, but this is more than made up for by the development of needs for wood along new lines or of greater needs along old lines. Only rising prices can serve to lessen the consumption of wood by an advancing nation, and after wasteful use has been cut off, any further reduction means an economic disadvantage. It means harder conditions of life, a handicap on industry.

In the United States our use of wood is lavish. By better methods in the woods, at the mill, and in ways of use we can make what we have go further than we are now making it go, without industrial hardship. On the other hand, our legitimate need will certainly not decline, but advance as we go on to greater industrial strength. We can without hardship reduce our per capita consumption through economies; but after we have reached a reasonable basis we must expect to see our needs advancing again. We are like a growing family which is extrava-

gantly living beyond its income, but which is sure to need, when it has cut off extravagant use, an advancing income through future years.

We have manufactured more lumber and other forest products than we require. That is, we have established a consumption per capita, based not merely on actual need, but on a lavishness, a disregard for possible substitutes, and a scale of waste in the use of wood equalled in no other country. Supply has been regulated to a demand swollen not so much by industrial development, great as it has been, as by a product unduly cheap, because the items of logging and manufacture were considered the main costs of producing it. The cost of growing the trees has always been left out.

That there is, in the economic sense, overproduction of lumber is wholly true, because we manufacture more lumber than our forests can yield permanently. No economic reason fully explains the difference between the price of lumber grown in the United States and of lumber grown in Europe. Difference in the density of population explains it only in part. But neither that nor the relation of supply to demand is the chief cause. It lies in our failure to realize that if we are to grow timber continuously to meet our needs its value must be reckoned by the cost of growing it as well as by the cost of logging and manufacture.

We pay generally less for lumber than it is worth, with a slight present gain to ourselves individually, and by so doing we discourage the right use of the forest and greatly increase the cost of lumber to ourselves later on, and to those who come after us. We must recognize the actual value of timber now or pay an excessive price for it in the future, and we have carried destruction so far that we shall probably have to do both.

LOSES OUT.

In a case, the opinion of which was handed down May 11, the Interstate Commerce Commission found that water competition forced down rates from interior points to Pacific coast terminals.

The situation was peculiar. The carriers increased the rates on farm and dump wagons from Missouri River territory to the Pacific coast from \$1.25 a hundred pounds to \$1.35, the reason announced being that the former rate was abnormally low.

Subsequently it was discovered that wagons were being moved to the Pacific coast terminals by water and the \$1.25 rate was restored. The restoration of the rate induced the Kentucky Wagon Manufacturing Company and the Milburn Wagon Company, of Toledo, O., to institute complaints before the commission demanding reparation on shipments on which they had paid the \$1.35 rate.

The commission denies the reparation, holding that the carriers were forced by water competition to restore the lower rate in order to get the business and not because the higher rate was unreasonable.

COST OF POWER.

The cost of power for each tool can be obtained by ascertaining the power demand in kilowatts per hour and multiplying this number of power units by the cost per unit and the number of working hours. If power is generated under the shop management, its cost must be determined from the station records; if purchased, the contract price must be used.

When the machines are equipped with individual motors records for each class of work may easily be obtained by the use of graphic recording meters.

UNIONIZED.

The shop of J. J. Walsh & Co., of Roxbury, Mass., was completely unionized by carriage and wagon workers. The addition makes 74 shops, large and small, under union conditions in Boston and vicinity.

How an Aeroplane Works

IN talking of the present and future of the aeroplane the other day, Glenn H. Curtiss, then preparing to start on his now famous flight down the Hudson River, ventured the opinion that the success of power-flight lay entirely in the perfection of the controlling gear. He meant particularly the gear than controls the direction and stability of the flyer. Whoever desires to understand the aeroplane and its method of flight may as well take that significant remark to heart before he starts in.

When men started to try to fly they did not know what they were about. They thought that it would be sufficient to provide the power to their machines and the kitelike surfaces to raise them. It did not occur to them that a kite, even with a long tail and no weight to carry, plunges and tumbles in all sorts of dizzy ways. So when men invented an engine sufficiently light and powerful, and fixed to it the slanting planes to take it aloft, they were very much puzzled at first to find that their machines invariably crashed down to earth after rising a few yards.

They had started out with a rudder, something like a ship's rudder, to turn their aeroplanes to right or left. That was not enough. They next added a second rudder to turn upward or downward with. This was not enough either. So then came along the Wright brothers with their one all-important contribution to the construction of the aeroplane. They produced a device that would keep the flyer "on an even keel," as we say of a ship; that is something that would save it from overturning sideways.

Finally, then, the flying men have made among them all the aeroplane of to-day. Their product is a machine that will go rapidly and straight through the air and will keep steady and level in fairly quiet breezes. The machine is not automatic. That improvement is yet to come. As yet, every swerve, lurch and dip of the aeroplane has to be counteracted by a conscious and skillful use of one of the "controls."

With the accompanying diagrams and the explanation here given any one may understand how the aeroplane is made to go. Various makes of aeroplanes differ in minor points, of course. Almost all however, have these points in common; up-and-down or "altitude" rudder in front, lateral rudder behind and "stabilizing" rudders at the extreme wing tips of the aeroplane.

The aeroplane of Glenn H. Curtiss, in which he made his Albany-New York flight, is one from which the accompanying diagrams are drawn. The Curtiss machine is held to have proved itself, by the recent flight, the most advanced type of aeroplane yet devised in America, possibly the world. It has possibly a little less stability and endurance than the Farman biplane used by Paulhan, but it excels the Farman biplane in speed. In design, the two models closely resemble each other.

The Curtiss aeroplane is shown in ground plan in Fig. 1. The aeroplane flies in the direction indicated by the arrows. A is the altitude rudder, perched out at the end of a bamboo framework, in front of the driver. B B, are the two stabilizing rudders, out at the ends of the planes. C is the rudder for lateral steering, perched out behind, as A is before. P P is the upper sustaining frame, four feet under which lies the lower sustaining plane, parallel and of the same shape and size. In front of the planes is the steering wheel, W. Just back of W is the aeroplanist's seat, S. Back of S, and between the big planes, is placed the engine. Back of the engine and behind the big planes is the propeller, X.

In the type of aeroplane now most developed, the propeller,

X, placed behind the engine E, and the driver, at S, forces the machine forward in a horizontal direction. The planes, P, P, catch the air on their under surfaces, slightly inclined and concaved for that purpose. The pressure lifts the machine in the air or sustains it there at a desired level.

The engine that supplies the power is a gasoline explosion motor closely similar to that used in automobiles. Only slight differences are necessitated by the adapting of the engine to the aeroplane. The radiator and cylinders are built and grouped to save as much weight as possible. The controls for the magneto and gasoline supply are placed forward of the engine, at the driver's seat, S, for he is under the disadvantage of sitting in

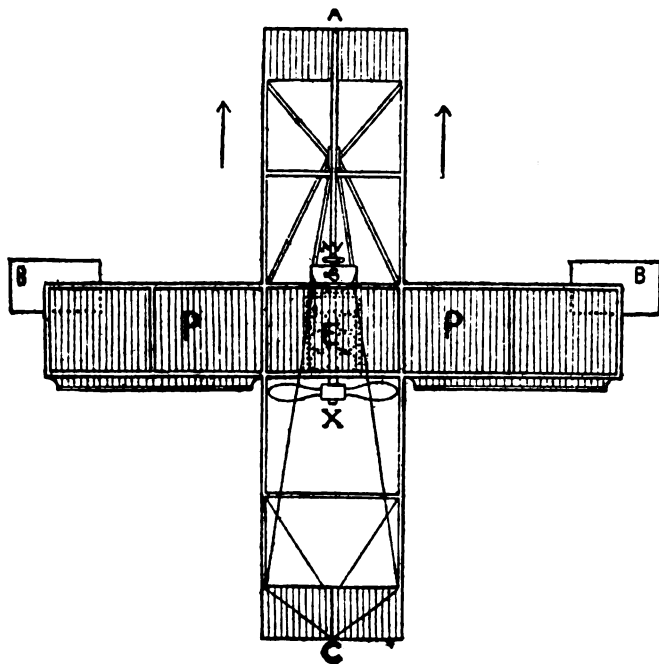

FIG. 1.—GROUND PLAN OF CURTISS AEROPLANE.

front of the motor. The engine cranks up directly by a turn of the propeller and the shaft drives the propeller directly without the intervention of cogs or sprockets. With these exceptions the flying engine is in all respects like the automobile engine, and does not require any explanation of its own.

It is now to be seen how the propeller, X, driven by the engine, E, sends forward the machine, which is sustained by the gliding on the air of the plane, P P, and the similar plane under it. There remains to be seen the more delicate and difficult part of flying, namely the work of keeping the flyer straight and level. Each of the rudders, A, B B and C, does its own particular share of this work. It is a threefold work, and far more complicated than the control of automobile, ship or bicycle. All these travel on a horizontal surface and are guided only to right and to left. Only the submarine boat presents anything like the complications of steering that beset the aeroplane, for the submarine boat alone besides the flyer navigates in three dimensions.

The function of the forward rudder, A, is to turn the course of the aeroplane up or down. Right here the tremendous difference between the aeroplane and almost all methods of locomotion known to us becomes apparent. To realize the difference it is only necessary to try to conceive an automobile that one could, by a turn of the wrist, start to soaring from the ground. Nothing else so free and complete in the whole realm of motion, as known to human experience, exists as in the aeroplane of to-day, rude and imperfect, compared to its prospects, as it still

presumably is. And the freedom and complete command of space that distinguish the aeroplane all lie in rudder A, the altitude rudder.

Figure 2 is a drawing of the essential details of this wonderful rudder. The rudder is shown from a point of observation forward of it and to its left.

The rudder consists of two horizontal planes, p p. They are connected with a framework similar in shape to the skeleton of an oblong box. This framework has the planes p p for its top and bottom sides. The framework hinges at the two ends on the axis represented by the dotted line, a. It is by turning on this hinge that the planes are made to act as rudders.

This action is produced in the following manner: When the framework is tilted so that the fronts of the planes point upward, the air through which the aeroplane is advancing catches

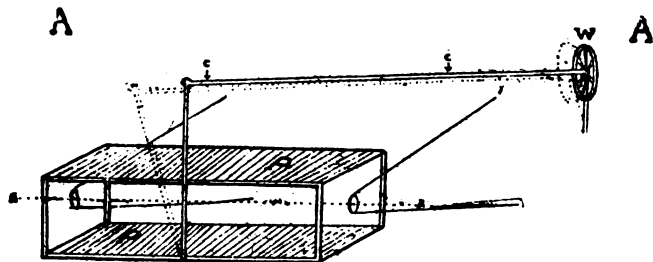

FIG. 2.—ELEVATION OF ALTITUDE RUDDER, A.

on the under side. The pressure of the air on the under sides of the planes lifts them and so lifts the nose of the whole aeroplane up, making it take an upward direction.

When, on the other hand, the planes p p are tilted downward, the air as it is cleft presses on their top surfaces and forces them to point earthward. And so they give the downward direction to the course of the aeroplane, when the flyer desires to fly lower.

It will easily be seen that without the altitude rudder, A, the aeroplane would be helpless. It could not be depended upon to rise from the ground, for flight is started by giving the rudder the little upward tilt. The aeroplanist could not safely descend earthward, nor, if he found himself in unfavorable air, could he pass from one air current up or down to another. Above all, he could not alight, for in the last moment before alighting the nose of the aeroplane is thrown sharply up, to let the great planes catch the air and stop the momentum.

How is the altitude rudder controlled by the aeroplanist? The view in Fig. 2 shows this in the apparatus, C C C. This is a peculiar but perfectly simple device. The rudder is pushed forward or pulled back by a long rod. The rod runs from a cross-piece of the framework of the rudder back to the steering wheel. It is fastened at the hub of the wheel. The wheel works backward and forward as well as turning.

So the same hand that is steering the aeroplane to right or left by a turn of the wheel can, at the same time, be raising the aeroplane by drawing the wheel back toward the driver, as one "picks up" a stumbling horse, or else forced earthward by a forward thrust.

More vital still than the altitude rudder, and certainly more of a departure from all other known methods of equilibrium, are the stabilizing rudders or fins, B B. The working of these is shown in Fig. 3

To understand the use of them, the most continuously employed pieces of steering gear on an aeroplane, it is necessary to remember that an aeroplane is poised as delicately on its airy even keel as a tightrope walker on his wire. The stabilizing fins serve the same purpose as does the fan of the Japanese tightrope performer. They save the flyer from tipping over to one side or the other.

Fig. 3 will show how this is done. Once more it is an application of the principle of catching the wind on the under side of a horizontal plane to get an upward pressure, and on the upper

side to get a downward pressure. Fig. 3 shows a front elevation of the stabilizing planes and as much of the rest of the aeroplane as is necessary to the comprehension of their action. The purpose of the arrangement here shown is to tilt the one plane upward and the opposite one downward at the same time.

The control of the planes, B B, lies in the wires c c c c. The axis of each plane lies in the dotted line, A. The wires, c c, fastened behind the axes of the planes, tilt them by an upward or downward pull. The wires c c run down from each plane to a pulley at the corner of the lower sustaining plane, P. From the pulley they run straight to the top of the back of the driver's seat, S. There they are fastened.

This seat-back swings from side to side like the backs of some old chairs. The difference is that the old chairs were not designed to sway, while this back is. When it sways to the right, it pulls the wire that draws down the rear of the stabilizing wing out at the left wing tip. When the seat sways to the left, it draws down the stabilizing plane at the right wing tip.

The wiring, C C, runs also up from the tops of the stabilizing planes through pulleys overhead, and so connects the stabilizing planes from above. When therefore, one stabilizing plane has its after edge pulled down by the tilting of the seat back, the same pull communicates by the wire over head to the other stabilizing plane, pulls its rear end up. Whichever way the one stabilizing plane is turned, the other one is turned oppositely.

The manner in which this action rights the aeroplane will be readily understood. The process is as follows: As soon as, in the course of flight, the aeroplane sags to the left, the driver leans over to the right in his seat. It is the motion that he would naturally make to find his own equilibrium. In leaning to the right he pushes the seat back over with him. This pulls the wire that draws down the left stabilizing fin's after part. Thus the fin turns on its axis, or in such a way as to present a slanting under surface to the wind. The wind delivers an upward pressure on this surface, and this upward pressure tends to right the sagging left end of the aeroplane. At the same time the pull that started from the seat back is sent on from the left fin over the overhead wire and down to the upper surface of the right fin, which is drawn up. The right fin is thus made to present its upper surface to the wind, and the wind then depresses the right end of the aeroplane at the same time that the left is being raised. In a moment the aeroplane is righted. The driver thereupon straightens up in his seat bringing the seat-back again to the upright position and so drawing the stabilizing fins back again to their original place. The movement is a natural one for the driver, so much so as to be semi-automatic.

It often happens that an aeroplane is caught in an air current as knotty as a rough pine board. A puff of wind will blow one side up, or the other side down. It is then that the aeronaut's

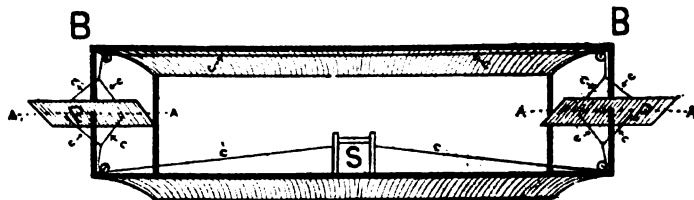

FIG. 3.—FRONT VIEW OF STABILIZING PLANES, B, B.

back and shoulders are put to quick use to right his machine. The rule is simple; always to bend toward the upward side. Often in making a curve, also, the aviator is obliged to lean a little inward, if the curve be sharp, to counteract the centrifugal force. The aeroplane naturally tilts on the inward side when taking a sharp curve, because of the slackening of the speed on the side which has the shorter curve.

The third of the important controls of the aeroplane in the air is shown in Fig. 4. It is the side-to-side steering gear, the most complicated, because it is the least important. It needs a second motion of the hands, which are already busy with the altitude control. But the side-to-side steering motion does not

interfere with the pushing and pulling by which the upward and downward course of flight is directed.

Figure 4 shows a view of the side-to-side rudder C. It is cleft, and through this cleft passes a horizontal plane. This is just a fixed plane, placed to sustain the weight of the after end of the aeroplane. The rudder C, save for this cleavage into an upper and lower part, is very similar to a ship's rudder. It is noteworthy that this is the only vertical plane on the whole Curtiss

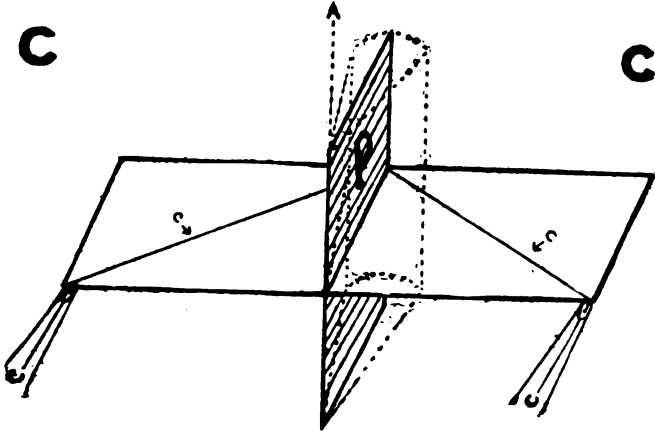

FIG 4.—ELEVATION OF SIDE TO SIDE RUDDER, C.

machine. The rudder C swings on a vertical axis, a. The positions into which it may be swung are shown by the dotted lines.

The control of this rudder is by the little wires, cc, which pass through pulleys at the corners of the horizontal plane and come forward to the driver's seat. They pass up to the steering wheel, W, circle this, and unite. In other words, the wheel of the aeroplane is very much like a ship's wheel, not only in purpose but in design.

It is with this wheel, of course, that the driver turns to right or left, doubles on his course and makes the most complicated evolutions. Yet, in view of the fact that going anywhere in particular is vastly less important than avoiding being dashed to the ground, the side-to-side steering gear is far less an essential to the aeroplane than are the up-and-down and stabilizing planes. Nor is it in any sense an invention in aeroplaning, since it is closely copied after the steering gear long in use on the water.

There are other things that the aviator has to attend to besides his direction and stability control, of course. But they do not require his ever taking more than one hand from the steering wheel. There is the throttle which feeds the fuel to his engine. It is a short, slender lever, at his right hand. A brief motion cuts off his fuel and shuts down his engine, or lessens his speed or increases it. The electric control is in a little twist button fastened on the front of his seat between his knees.

In starting, Curtiss, after testing his engine, first takes his place in the driver's seat, turns on the throttle and grasps the

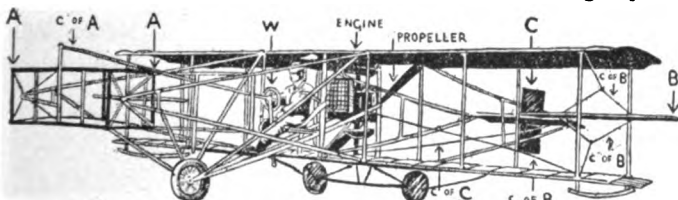

FIG. 6.—VIEW OF THE AEROPLANE, SHOWING THE VARIOUS PARTS.

steering wheel. Then, while two or three men hold the machine from darting forward on its wheels, a mechanic starts the engine with a quick turn of the propellor. With the propeller going briskly, Curtiss gives a signal, and the aeroplane is released by the men holding it. When the right speed is reached, Curtiss pulls the steering gear back a little toward him. The aeroplane rises from the ground. The ground friction overcome, it gains speed rapidly and rises faster, till it reaches the desired level.

In descending, Curtiss picks out with his eye the favorable

spot. When within some 200 yards of it and at some twenty yards' elevation, he shuts off his engine with a movement of the right hand. Depressing the head of his flyer, he glides down at a gentle angle by his own momentum. At the moment before he would come into forcible collision with the earth, he pulls up the head of the flyer quite sharply. The nose points sharply up, the great sustaining planes act as brakes against the air. The strength is taken out of the drop. The machine comes down gently on its two rear wheels, and the front wheel comes down also. If the machine rolls along too far on the ground Curtiss applies a brake to the front wheel with his right foot. The same contrivance that works this brake has an emergency attachment to short circuit the electric current, if needed, when in the air.

Other important moments occur in the course of flight. Sometimes a motor stops in midair. In such a case, the aviator must pick out a landing place immediately and glide down to it. He may be 1,000 feet or more in the air, or he may but a few yards to descend. The greater drop is the safer in some ways, for there are more good landing places to pick out. The aviator, having set his eye on the desired landing spot, proceeds to glide to it, by the careful use of his altitude rudder. He must keep this rudder pointed downward just enough so that the machine will slant downward at a fair speed. It amounts to making gravity supply the place of power. He coasts down on a gentle slant. If he slants too much, he is in danger of being dashed down at a terrific rate. If too little, he may lose headway and so lose stability and steerage way, and meet an even worse disaster by overturning. So it takes an exceedingly nice use of the altitude rudder to make a landing with the engine cut off.

Delicate and interesting as the contrivances of the most manageable aeroplanes of the day may seem, it must be remembered that there is yet much to be accomplished before they will become satisfactory means of travel. Their stability is not yet great. In a violent wind they are tossed mercilessly, or upset, despite the stabilizing planes. And in the best weather the three-fold difficulties of steering demand a constant attention much more trying than that employed in speeding an auto at forty miles an hour.

WAGON MAKERS SAY IT'S A FAD.

Automobiling is a fad and the time is fast approaching when the wagonette, the brougham and the carriage will come back in vogue, according to D. J. Keck, who spoke on the waning of the automobile at the annual banquet and smoker given by the St. Louis Carriage and Wagon Builders' Association Monday night.

The seventy-five members present agreed that the "joy-riders" and the great number of fatalities caused by automobile accidents had a tendency to rejuvenate the carriage and wagon business of the country.

"Many wagon manufacturers," said Mr. Keck, "would probably have embarked in the automobile business had they thought automobiling would be a fixture in this country. It is true the fad temporarily hurt our trade, but the time is fast approaching when the conservative man will forsake the gasoline vehicle for the reliable carriage."

Among the other speakers at the banquet besides Mr. Keck were: William Schaeffer, William Oldenhaus, Fred Butler and Henry Eichs. G. H. McCabe was toastmaster.

The officers of the St. Louis Carriage and Wagon Builders' Association are: Frederick Butler, president; Frank Krong, vice-president; Louis Neibling, treasurer; Frederick Spedy, financial secretary, and Frederick Heimberger, corresponding secretary.

THE RED FLAG.

Following assignment of the old and respected Boston company of Ferd. J. French Company, is a sale to close out the entire stock of carriages by order of the assignee.

OBITUARY

Louis Noll, of L. Noll Co., Waterford, Wis., vehicle dealer, died, aged 76 years.

Henry John Frank, treasurer of the firm of Donigan & Neilson, Brooklyn, N. Y., carriage and wagon builders, and a resident of South Brooklyn for forty years, died on Sunday, May 24, at his home, 345 Fifty-seventh St. He was born in New York City May 22, 1866. He is survived by his widow and a son.

J. B. Fitzpatrick, a prominent citizen of Columbiana, Ohio, was stricken with appoplexy and died. Mr. Fitzpatrick was prominently identified with the buggy manufacturing industry for many years.

Philip J. McGrath, a carriage builder of Brooklyn, N. Y., died at his home, 701 Lafayette avenue. He was born in Ireland and located in Brooklyn thirty-five years ago.

Patrick Burns, for more than 50 years a manufacturer of wagons in Hamilton, Ohio, died April 25 of Bright's disease, at the age of 77. He was a native of Ireland. He became widely known as a manufacturer and amassed a considerable fortune. He was the father of M. O. Burns, prosecuting attorney of Butler County.

William Zottman, one of the oldest citizens of Burlington, Vt., died May 22 of arterial sclerosis. Mr. Zottman was born in Philadelphia in 1823. He was engaged for some years in manufacturing carriages associated with William Smith. Mr. Zottman leaves a wife, one son, and a half brother.

John C. Fancher died in Jacksonville, N. Y., May 23. He was a carriage manufacturer, retiring from business eighteen years ago. He is survived by three sons and one daughter.

Alexander McDowell, of Monmouth, Ill., died at the age of 80 at the home of his son-in-law in Chicago, May 22. Born in Philadelphia, August 2, 1834, Mr. McDowell went to Illinois in 1865 and began the manufacture of carriages at Monmouth, where he resided until a few years ago. He then went to Chicago, but more recently returned to Monmouth. He is survived by his wife and daughter.

Eugene T. Westerfield, a retired wagon manufacturer of New York City, died May 22. He was born in New York City August 11, 1842. He is survived by four sons, a daughter, a brother and a sister.

William Harvey Rowland, secretary of William & Harvey Rowland, Inc., manufacturers of carriage springs, at Philadelphia, died May 22 at his home in Chestnut Hill, after a short illness from typhoid fever. Mr. Rowland was a member of the Philadelphia Cricket Club, and was well known in society. He was a member of the old and distinguished Rowland family which did so much in the upbuilding of Frankford.

Austin C. Chandler, a retired carriage manufacturer, died at Springfield, Mass., May 14. He leaves a son and daughter.

Warner Arms, of Youngstown, Ohio, president of the Republic Rubber Company, died at the age of 58.

Christian Zecher, a well known resident of Lancaster, Pa., died May 10. Deceased was in his seventy-fifth year and death was caused by diabetes. He was born and resided all his life in Lancaster. When a young man he learned the trade of wagon builder and for a number of years was engaged in the wagon making business with his brother, Philip, retiring several years ago.

Aaron Benson Ragan, vice-president of the Southern Vehicle and Manufacturing Company, died in New Orleans, La., May 1, from a complication of diseases that followed an attack of la grippe. The deceased was born in Thibodaux, La., sixty years ago. He entered the employ of the Joseph Schwartz Carriage Company, and worked in almost every capacity in the store. Three years ago he and Captain Alex Hass and Leon Wolf or-

ganized the Southern Vehicle and Manufacturing Company. His wife, three sons and five daughters survive.

John Donohoe, an old citizen of Belvidere, N. J., who for many years was engaged in the manufacture of wagons, died at the home of his son-in-law Samuel Hendrickson, May 1, aged 80 years. He relinquished active business several years ago on account of ill health. He is survived by one son and one daughter.

LO IN THE PAINT SHOP.

Whether or not it is the ancestral love of paint streaked about their faces, or a new era for the red men, at any rate four young Indian bucks from the Tama reservation have laid aside their blankets and moccasins and donned the overalls of the laborer, and are working in paint, in the factory of the Marshalltown (Iowa) Buggy Company.

Never in the history of that city, which has had an Indian reservation near it for many years have Indians been known to accept employment. One of the young braves started in the factory and was placed at work priming buggy bodies and gears. The weekly pay checks looked good to him and the word was passed in the native Iowa Sac and Fox tongue. The result was three more of his race joined him and their employers pronounce them good workmen.

HOW CAN IT BE PATENTED.

In the April Hub, in the new patents department, we illustrated a turnout seat with a brief of the claimed specifications. It was assigned by the patentee to a motor car company of some prominence.

Referring to this in a letter to The Hub, a carriage builder of the first class thus comments with justice, and not a little irony, at the expense of those who are so little posted on the art of body building, as not to know what they are buying. He writes.

"Is it possible that a patent could be issued by the patent office for a turnout seat, or a body made like that (referring to illustration). That seat has been made in the carriage trade before I went into business and I have been engaged in it for thirty years."

The writer wonders why it might not be a valuable idea to patent everything that was ever used in the carriage trade.

THE MERITAS MILLS.

The Meritas Mills of Columbus, Georgia, have filed a petition in Superior Court of Columbus, Ga., asking for a charter for a cotton mill, capital stock of which is to be \$500,000. Twenty acres of land have been purchased for a site at North Highlands on the river. Plans call for the erection of a two-story brick mill and a weave shed with saw tooth roof, for an initial equipment of 10,000 spindles and 170 looms and provision for an increase to 25,000 spindles and 425 looms. The machinery will be driven by electricity and produce cloth used as a basis for the celebrated "Meritas Leather Cloth." The project is backed by the Standard Oil Cloth Company, of 320 Broadway, New York.

AUTO PAYS THE FREIGHT.

The railroads of the United States earn over eight million dollars a year carrying automobiles, supplies and accessories. They have profited largely by the development of the industry, as they would naturally profit by the success and extension of any product, but the automobile industry has been exceptionally productive of revenue for the railroads. A factory pays for ten times as many freight cars and at a much higher rate than a carriage factory producing an equal number of horse drawn vehicles.

WHAT BUILDERS ARE OFFERING.**The Month's Fashion Plates Described.****(See Fashion Section for Illustrations.)**

The Mylord is an Austrian style of pleasing design, and is shown more for the purpose of giving an idea of what the foreign builder is doing in pleasure vehicles of heavy type.

The Studebaker Bros. Mfg. Co. has created the design of automobile here shown which has been named the "Emperor William." The idea worked out is that of a body on close-coupled car that shall yield luxurious riding qualities with beauty of design. It has many excellent attributes that a study of the drawing will develop, and the finish, painting and all elegant accessories are up to the full Studebaker standard.

The Winton Motor Carriage Company, of Cleveland, has always maintained a very high standard in design, trimming and painting, and its cars appeals to the refined taste. The company believes in the exclusive six-cylinder power plant for reasons that are cogently presented. For 1910 the buyer is given four forward selective speeds, which is the addition of an extreme speed. A newly perfected carburetor emphasizes the motors beautiful operation. The frame is inswept in front to give a shorter turning radius. Springs of increased size are semi-elliptical all around, permitting low suspension of body. Four shock absorbers and four rubber bumpers. The front axle is of channel-section pressed steel. Wheel base is 124 inches—an increase of four inches. The body is longer and wider, also running boards and guards. Running boards and front floor are covered with pressed aluminum.

The American Locomotive Company has been very successful in meeting the requirements of users of heavy commercial trucks, and we present this month a type of the four-cylinder, 20 H.P. truck equipped with standard body. The company made exhaustive research, testing all approved ideas, before creating the model it thought most worthy.

The truck has the same motor as the cab, but the governor is set for one thousand revolutions, at which speed twenty-four horsepower is developed. This model has a chain drive, which is the better practice for a commercial vehicle. The chassis is fitted with semi-elliptic springs and solid one-piece axles of rec-wheels. The length over all is one hundred and ninety-seven inches, standard. The width of the frame is seventy-eight-and-a-half inches, over the front hubs, and seventy-seven and fifteen-sixteenths inches over the rear hubs. The length of the loading space is twelve feet, with the standard body, the width being optional. The height of the frame, when loaded, is thirty-six inches. The weight of the chassis is 4850 pounds. The gasoline tank has a capacity of twenty-one gallons.

The Matheson Automobile Company, of Wilkesbarre, Pa., has scored such a brilliant success with its "Silent Six" cylinder cars that one must take notice of the achievement. The illustration is of a five passenger touring car equipped with its six cylinder power plant. The excellence attained seems to rest largely on extreme precision of construction in all mechanical details, with such ideas in design as have approved themselves to the makers after painstaking test and try-out. The body of the car shown is graceful in design and presents a very workmanlike finish.

EVANSVILLE HIGH WATER MARK.

Twelve thousand buggies made in March and April establish a new high record of production at the Hercules Buggy Company's plant, and the payroll of more than \$11,000 for the week established the high mark of weekly wage totals not only at the Hercules but for all business in Evansville.

RUBBER STOCKS AS VIEWED BY EXPERTS.

Offerings of crude rubber in the London market recently met with no buyers at the upset prices and lots were withdrawn. The Motor World prints interviews from Henry C. Pearson, of the India Rubber World, and F. A. Sieberling, president of the Goodyear Tire and Rubber Co., that may be considered as the views of experts.

"The rubber manufacturer, from the beginning of the industry," says Mr. Pearson, "has been in a position of not being able to control in any way the cost of the chief material, or calculate with accuracy the cost of material at any given time ahead.

"Many manufacturers seem disposed to consider every rise in the cost of rubber to be due to 'speculation.' Of late this impression apparently has been strengthened by reports that rubber is being 'held up' on the Amazon with the aid of the government, under the new law authorizing banks to advance money on rubber stocks.

"Whatever may be the ultimate effect of the new regulation, it is a mistake to suppose that rubber is being stored on the Amazon to-day, with the aid of bank advances or otherwise. The price of \$3 a pound is so alluring that every producer in the world is hurrying his rubber to market.

"On the whole, it appears safe to assert that rubber prices to-day are as fully controlled by conditions of supply and demand as at any other time in the history of the trade."

Mr. Sieberling recently returned from his tour of inspection through South America that took two months' time and more than 2,000 miles of travel in the fever-laden district of the Amazon river. He was, so far as known, the first American rubber manufacturer to take this trip. "The high prices prevailing for crude rubber," says Mr. Sieberling, "are fairly attributable to two primary causes: First—the abnormal draft upon the world's supplying in providing tires for automobiles; second—the wild speculation in rubber and rubber shares in England. London is the financial center of the world's rubber market, and the craze now running its course there is having a tremendous sentimental influence toward lifting prices. This will correct itself in the collapse which is certain to come.

"Stories are being circulated to the effect that the rubber supply is being rapidly exhausted, and that the world is facing a famine; but a careful review of the situation justifies an opposite opinion.

"The past year more than 70,000 tons of crude rubber, having a value approximating \$300,000,000, were produced, of which 40,000 tons came out of the Amazon district. This was wholly wild rubber, gathered almost entirely from a belt extending along the Amazon and its tributaries and running less than three miles into the interior. The vast forest beyond these borders is substantially untouched; but with the building of the railroad around the falls of the Madeira—which will be completed in 1911—and with the building of roads through the forest connecting up rivers, the introduction of the automobile and gasoline boat, vast districts heretofore inaccessible will be brought within reach of the rubber gatherer; and, while the gain in production each year has been approximately but 10 per cent. over the previous year, there is no question that this percentage will increase largely from this time forward.

"But a very important factor toward relieving the existing situation is found in the plantation rubber in the East Indies, which is now coming into the market in large quantities, each year's production being substantially double that of the preceding year. Whereas we had less than 4,000 tons in 1909, we shall receive approximately 8,000 tons in 1910 and well up to 16,000 tons in 1911, and within five years a quantity larger than is now furnished by the Amazon, which is a remarkable result considering the fact that three years ago the production of the entire East Indian district represented but a few hundred tons.

"That product of nature which exists in abundance, and which the world needs, it will find a way to obtain. Wild rubber trees

in almost limitless quantities exist in Brazil awaiting the touch of human energy to yield up their latex, and the world will undoubtedly find means to obtain its required supply.

"The ruling classes in Brazil are an intelligent people, and though they have been slow to realize the advantage of planting rubber, they are now following the lead of the East Indians, and within a few years the Amazon Valley will be furnishing plantation rubber far in excess of the wild rubber now coming down the river.

"As an indication of the immensity of its opportunities, one island in the mouth of the Amazon River, Isle Marajo, which is larger than the State of Maine, is capable of furnishing plantation rubber in quantity more than the entire world is now consuming. The government is enacting legislation to stimulate the planting of trees and, while we shall temporarily be subjected to high prices of crude rubber, since it is known that plantation rubber can be produced for 25 cents a pound, as certain as night follows the day we will within a few years have a large over-supply that will bring the cost lower than it has ever been heretofore."

PERSONALS.

C. D. Eyrse, superintendent of the Pekin (Ill.) Wagon Company, has resigned his position. Mr. Eyrse has had thirty years of experience in this line of work.

Victor Freeman, who for several months has been employed in the Shortsville Wheel Co's factory at Littleville, has resigned his position and returned to his home in Geneva, N. Y.

The governor of Indiana appointed W. H. McIntyre, of Auburn, delegate to the International Congress of Road Builders, which meets in Brussels, Belgium, April 31 to August 7.

E. H. Brewer and Jesse Jennison, of the Cortland (N. Y.) Carriage Goods Co., have just finished an auto trip from Florida to Cortland. One day's stunt was 169 miles. The machine was a 30 Cadillac.

Howard Ames, who returned from Montreal a short time ago, having been employed in that city by Carroll & Co., has resigned his position with that company and accepted one with the Byrnes Carriage Co.

O. D. Small resigned his position as general manager of the Golden Eagle Buggy Company May 1 to take charge of the Piedmont Orchards Company, which comprises about 1,500 acres of fine orchard lands near Clarksville, Ga.

James A. Kauffman, Miamisburg, Ohio, has accepted a position with the Anderson Carriage Company, Detroit, builders of electric autos. Mr. Kauffman has been secretary of the Kauffman Buggy Company for over twenty-five years.

Announcement has recently been made of the appointment of M. J. Hallinan, effective June 1, as manager and city salesman for the wholesale department of J. L. Marcero & Co., Pontiac, Mich. Mr. Hallinan was formerly purchasing agent and vice president of the Pontiac Buggy Co.

Charles T. Jeffrey, who for sixteen years was a partner with his father, the late Thomas B. Jeffrey, in the firm of Thomas B. Jeffrey & Co., now assumes complete control of the manufacture and sale of Rambler automobiles. It is announced that the business of Thomas B. Jeffrey & Co. will continue without change in policy.

The Fort Wayne (Ind.) Auto Axle Company elected the following officers: President, Van B. Perrine; vice-president, J. R. Keenan; secretary, H. C. Pequinot; treasurer, W. H. Scheiman. These gentlemen, with W. M. Griffin, constitute the board of directors. The capital stock of \$100,000 has been subscribed and the factory will be in operation shortly.

Seventy years ago H. L. Fisher of the Fisher Bros. Buggy Company, arrived in Peoria on a small river packet steamer, a boy of 4 years of age. Mr. Fisher remembers incidents attending his arrival in Peoria vividly. The city was then but a village of 600 inhabitants, but enjoying a boom and growing rapidly. Shortly after his arrival Mr. Fisher journeyed in a stage

coach to the town of Charleston, now known as Brimfield, where he resided for a number of years. Later he moved to Peoria.

At the annual meeting of the stockholders of the Stoughton (Wis.) Wagon Company, the following directors were elected for the ensuing year: J. H. Palmer, Dr. Julius Noer, Henry Beattie, F. J. Veal, M. M. J. Veal, P. M. Davis and Oscar Forton. Immediately after the stockholders' meeting the board of directors met and re-elected all of the old officers.

Charles Abresch, founder of the Charles Abresch Company, builders of carriages, trucks, beer wagons and automobile bodies, in Milwaukee, Wis., celebrated his sixtieth birthday May 15. by assembling the officers of his company and the men who have been longest with him at the factory, with their wives and friends. After showing them through the entire plant he took them to the Blatz hotel, where a dinner was served in the clubroom, followed by an automobile ride for the ladies, while the men visited over their cigars and wine. Mr. Abresch located in 1868, having learned his trade in Germany, and in 1871 started the Abresch Company, which now employes 650 men and has a monthly payroll of \$60,000.

HONK! HONK! KENNEDY!

Clyde C. Kennedy was gathered in by the reporter of a Frisco journal, and this is what was printed: "While East I visited a number of big automobile factories and everywhere was the same story of marvelous demand for this season's cars. There can be no doubt about the McFarlan popularity in the East. The factory at Connersville, Ind., was easily as busy as any that I visited and even by working night and day was finding it impossible to catch up with orders. There is an unmistakable tendency in the East for the six-cylinder car and I believe that necessity of successful competition will force a large number of the machines now using fewer cylinders to adopt this construction."

DETROIT DEALS.

Purchase of the Brush Runabout Company, and possibly, the Briscoe Manufacturing Co., the erection of one of the largest garages in Detroit at Woodward and Charlotte avenues; the building of the world's largest plant for the manufacture of light commercial cars, and the adsorption of the Gray Motor Company, are a few of the deals involved in Detroit properties either closed or about to be closed by the newly organized United States Motor Company.

CARRIAGE MANUFACTURERS MEET.

At the semi-annual meeting of the Carriage Manufacturers' Association of America, held in Chicago, plans were laid for enlarging the scope of the work in the future and the enlistment of all vehicle manufacturers in an effort to secure better conditions in the manufacture and marketing of vehicles. The present officers and their addresses are as follows: President, C. C. Hull, Connersville, Ind.; secretary, George D. McCutcheon, Owensboro, Ky.; treasurer, S. C. Gay, Ottawa, Ill.

TO RAISE THE DUES.

The members of the Kansas City (Mo.) Implement, Vehicle and Hardware Club will hold a meeting at the Baltimore Hotel to discuss the proposition of raising the annual membership dues to \$15. It is said that the organization suffers from a lack of revenue and the matter of a heavier assessment has been agitated for some time.

MR. McADOW RE-ELECTED PRESIDENT.

F. H. McAdow, secretary and treasurer of the Staver Carriage Co., was elected president of the National Association of Credit Men at their annual convention, held at Philadelphia last May.

Trade News From Near and Far

NEW FIRMS AND INCORPORATIONS.

The Robinson Motor Car Co., Detroit, Mich., has incorporated with a capital of \$20,000.

The Swift Automobile Co., Detroit, Mich., has filed articles under Michigan laws; capital \$300,000.

Owosso (Mich.) Motor Co., to manufacture delivery wagons, has been incorporated; capital \$200,000.

The Storm Queen Buggy Company, Huntington, Ind., has been incorporated by D. P. Miles, W. C. Miles, and W. M. Miles with a capital of \$30,000.

The W. T. Farr Co., Dalhart, Texas, hardware, implements, vehicles, etc., has been incorporated by W. T. Farr, W. B. McKinney and L. C. Elliot.

The Hale Buggy Co., Anniston, Ala., has been incorporated to manufacture, buy and sell buggies. Capital stock, \$25,000, paid in \$6,250.

Atlantic, Iowa, is to have an exclusive buggy establishment to be operated by S. H. Kirk, who is closing out his stock of farm implements.

A buggy factory has been started at Gleason, Tenn. Montgomery, Hart & Nichols are the owners, and they will make buggies and do repair work.

The Pike Spoke Co., Pikeville, Ky., has been incorporated with a capital of \$6,000. Incorporators J. A. Sanders, Henry Sagraves and Robert D. Wilson.

Martene Motor Car Co., Westfield, N. J., to manufacture automobiles, etc., capital \$25,000, has been incorporated by L. D. Darby, H. C. Darby and others.

Sheboygan, Wis., is to have a neck yoke factory. Otto Hardt and William Schultz have purchased the patents, plant and business for manufacturing a neck yoke.

The Storm Queen Buggy Co., Huntington, Ind., manufacturers, has been incorporated with a capital of \$30,000. Directors D. P. Miles, W. Miles, and N. W. Miles.

United Auto Company, of Newark, N. J., to manufacture automobiles, etc., capital \$100,000; has been incorporated by S. H. Levy, J. Sonnabond and P. J. Shotland.

The Bimel Spoke & Auto Wheel Co., Portland, Ind., has been incorporated with a capital of \$130,000. Directors Fred Bimel, J. O. Pierce, J. A. Fuqua and W. D. Schwartz.

The Findlay (Ohio) Automobile Company has been incorporated with a capital of \$10,000. Incorporators L. D. Firmier, F. E. Hurley, W. N. Pol and C. F. Fleming.

W. A. Wood Automobile Mfg. Co., to manufacture automobiles, capital \$3,000; has been incorporated by W. A. Wood, C. W. Kahlerth and F. Fitch, at Kingston, N. Y.

Junkers-Burdick Company, Chicago; capital, \$25,000; automobile and general mercantile business; incorporators: Otto Junkers, Winthrop Burdick, George J. Meier.

Shaw-Merrill Company, Chicago, \$10,000; to manufacture and deal in motor vehicles and appliances; incorporators, Howard I. Shaw, E. Raymond Bliss, Jr.; Lloyd Merillat.

The Horseshoe Auto Tire Co., of New York, to manufacture and deal in automobiles, capital \$25,000; has been incorporated by W. E. Holloway, W. Huber, New York City.

Eastern Auto Distributing Co., capital \$1,200, has been incorporated to manufacture and deal in automobiles, etc., by Leonard K. Clark, 150 E. 89th street New York City.

The Anderson (Ind.) Implement Co., dealers in implements and vehicles, has been incorporated; capital \$50,000. Incorporators: Sol Smelser, W. B. Smelser and T. M. Bevelhimer.

Chenango Auto Top Co., Buffalo, N. Y., to manufacture and deal in carriage and auto tops, capital \$2,000; has been incorporated by Edward Robinson, C. H. Tuttle and K. Besant.

The Pyle Spring Tire Co., of Indianapolis, Ind., to manufacture tires and auto parts, has been incorporated; capital \$50,000. Incorporators G. C. Pyle, W. G. Hunter and W. D. Pyle.

Rayfield Motor Car Company, Springfield, Ill.; capital, \$150,000; to manufacture and deal in automobiles, accessories and supplies; incorporators, J. F. Miller, E. E. Staley, Burke Vancil.

The Cortland (N. Y.) Motor Wagon Company, to manufacture and deal in automobiles, etc., capital \$100,000; has been incorporated by R. H. Jadwin, of 502 Adams St., Scranton Pa.

The Hamilton Motor Car Co., Greensburg, Ind., has been incorporated with a capital of \$50,000. Incorporators Harry Warder, C. P. Corbett, W. W. Bonner, H. T. Woodfill and D. A. Myers.

Kinkel & Buckley, Brooklyn, to deal in carriages, wagons and automobiles, capital \$10,000, has been incorporated by C. F. Buckley, of 278 Nostrand avenue, and Joseph Funkel, 269 Clifton street.

The A. J. Walker Stoops Company, New York, capital, \$15,000, has been incorporated by Alfred J. Walker, James G. Stoops, to manufacture and deal in wagons, carriages and automobiles.

The Selnik-Klinger Company, of New York, to manufacture and deal in automobiles, wagons and parts, capital \$5,000; has been incorporated by Henry Selnik, of 118 McKibben street, Brooklyn.

Lincoln (N. D.) Co-Operative Company, to deal in hardware, implements, vehicles, etc., has been incorporated; capital \$50,000. Incorporators John W. Kerber, John J. Johanneson and Albert J. Zenzeon.

The Mohican Manufacturing Company, Richmond, N. Y., to manufacture and deal in automobiles, airships, etc.; capital \$50,000; has been incorporated by E. P. Jaeger, Brooklyn, and W. T. Clute, of Elmhurst.

The full amount of \$10,000 in subscriptions to the capital stock of the Northwestern Wheel & Wagon Company assures the citizens of Bellingham, Wash., that the factory of the company will be established there.

The White Spot Safety Signal Co., of New York, to manufacture and deal in automatic signal for automobiles, carriages, etc., capital \$100,000; has been incorporated by L. O'Brien, and E. E. Davis, of Montclair, N. J.

Graham Differential Gear Company, Chicago, has been incorporated with a capital of \$150,000 to manufacture and deal in automobiles, accessories and machinery. Incorporators: Percival Steel, J. L. Tyrrell, G. J. Jeffries.

The Interstate Automobile Supply Company, Sioux City, Ia., is going into the manufacturing end of the automobile business. The company states that it is installing machinery and apparatus for making automobile parts and tires.

Geo. D. Aiken & Co., Twin Falls, Idaho, to deal in implements, vehicles, etc., has been incorporated with a capital of \$20,000. Incorporators Geo. D. Aiken, E. D. Kinney, E. C. Kinney, George F. Sprague and John M. Maxwell.

The United States Wheel Co., capital \$1,000,000, was incorporated at Albany, N. Y., to manufacture automobiles and other vehicles and cars. The directors include Joseph D. Tooker, Arthur T. Black and S. P. McConnell of New York City.

The Ramsay-Alton Mfg. Co., Cortland, Mich., which has heretofore produced Morris chairs, has decided to make auto tops, and plans are under way for the equipment of a portion of the plant with special machinery required in the new departure.

Articles of incorporation filed by The Case Co., Racine, Wis., show that the company will engage in the manufacture of threshing machinery, engines, separators, plows, harvesters, farm

machinery, wagons, buggies, automobiles and road making machinery.

The Newark (N.Y.) Wagon Company has been incorporated with a capital stock of \$10,000 and the following directors were elected: Stephen F. Sherman and Frank B. Moody, of Newark; Fred E. Wright and W. H. Osborn, of Mexico, and Edward Joslyn, of Syracuse.

The Cook & Wilkinson Company, New York, to manufacture and deal in wagons, automobiles, bicycles and vehicles of all kinds, has been incorporated with a capital of \$25,000 by Wm. B. Blain, No. 356 Henry street, Brooklyn; Geo. E. Cook, 69 W. 102d street; Lyman M. Wilkinson, 520 W. 151st street, both of New York City.

BUSINESS CHANGES.

The American Carriage Co., Detroit, Mich., reduced its capital from \$70,000 to \$28,000.

Samuel Widger, Churchville, N. Y., has rented his carriage shop and retired from business.

D. J. Beeman, wagon maker, Norwick, N. Y., has purchased the rubber tiring business of Dickinson Bros., same place.

Bustav Giese, Lincoln, N. D., dealer in hardware, implements, and vehicles, has been succeeded by the Lincoln Co-Operative Store.

Donohoe, Splinter & Co., Cuba City, Wis., general store, hardware, implements, vehicles, etc., will be succeeded by the Cuba City Co-Operative Co.

Bilse & Buri, Monroe, Wis., manufacturers of wagons, etc., dissolved partnership. Bilse sold his interest to A. J. Buri, a brother of his former partner.

W. D. Stevens, Joliet Ill., has gone into the premises formerly used by Campbell & Keeling as a garage. The garage business has removed to premises evacuated by Stevens.

The Weyher Mfg. Co., Whitewater, Wis., has filed an amendment changing its name to the Whitewater Mfg. Co., manufacturers of motor cars, and increased its capital from \$35,000 to \$50,000.

H. Z. Ward, dealer in implements and buggies at Ada, Mich., has bought the general store of John Smith, and takes possession. Mr. Ward will use the newly acquired storeroom for a display floor.

A. N. Camp is building a large annex to his wagon shop in Morrisville, Vt., and will move the plant of the Lilley Wagon Company from Cady's Falls. New machinery and modern appliances will be added.

Clark Power Wagon Company, Lansing, Mich., recently organized and took over the Clark Carriage Company's plant. They will manufacture power delivery wagons. 300 men will be employed when the plant is ready for business.

The Wabash (Ind.) Mfg. Company will establish itself at Terre Haute, Ind. Two carloads of machinery were shipped from the company's plant at Wabash, and the entire plant there will be dismantled. The company will manufacture wagons.

Ross Durrell has purchased a half interest in the blacksmith wagon, carriage and automobile repair business of F. J. Wolt, South Bend, Ind. Mr. Wolt has conducted the business for 12 years and the new firm expects, with the enlarged factory and improved equipment to be better able to successfully accomplish any task it may undertake.

G. A. Van Duyn Company, which has been engaged for a number of years in the carriage business at Springfield, Ill., changed its name to the G. B. Hemenway Company. The purpose of the change is to continue the corporation in order to close up the business of the concern, which will probably not engage in active business in future.

A. T. A. Nelson Co., Cincinnati, Ohio, jobbers in vehicle trimmings and supplies, will in future be known as The Nelson-Alf Co., the change being due to the entrance of E. F. Alf as a partner in the business. This gentleman has for the past nineteen years been identified with the carriage trade, having been

connected with The Charles H. Albrecht Co., Cincinnati, Ohio. Lately The Nelson-Alf Co. has added to its former lines a number of specialties, including carriage and automobile trimmings and leather specialties, as well as vehicle cloths and carpets.

IMPROVEMENTS—EXTENSIONS.

Walter Smith, Milesburg, Pa., is building a new carriage shop.

The Beyster Detroit (Mich.) Motor Car Co. has increased its capital from \$50,000 to \$250,000.

The Oroville (Cal.) Vehicle and Auto Company has opened a new fireproof concrete garage.

Thomas Bassett Co., Ypsilanti, Mich., manufacturers of whiffletrees, has increased its capital from \$10,000 to \$25,000.

The Peabody Buggy Company, of Fostoria, has rented the room in Findlay, O., formerly occupied by Ewing & Alspach.

Breece Manufacturing Company, Portsmouth, Ohio, will expend \$10,000 to build an automobile spoke factory at Selma, Ala.

Johnson Service Co., Milwaukee, Wis., manufacturers of automobiles, has increased its capital from \$1,000,000 to \$1,500,000.

The general contract has been awarded for the \$2,000,000 plant to be erected by the Lozier Motor Co., in St. Clair Heights, Detroit.

The Robertson & Doll Carriage Co., of Denver, Colo., has gone into the automobile business. It has a complete shop for the building and finishing of automobile bodies.

The capacity of the plant of the Apperson Brothers Automobile Company at Kokomo, Ind., is being increased fully one-third by an addition which is now in course of construction.

The Carter Buggy and Implement Company, Springfield, Mo., is enlarging its plant by the addition of a new warehouse 105 feet wide and 121 feet long. The building is being constructed of concrete blocks.

Plans are being drawn for a factory building to be erected by the Velie Motor Vehicle Company at Moline, Ill., on ground recently acquired on the river front. Tentative plans have already been prepared.

The Schurmeier Motor Car Company, St. Paul, Minn., has let the contract for the erection of its automobile plant at University and Hamline avenue. The building will be 50 by 150 feet, brick, stone trimming, steel trusses, etc.

The Goshen (Ind.) Buggy Top Company is preparing to build a two-story brick addition between the old building and the smaller building on the corner of Second and Clinton streets. The additional space was needed for store room.

The Cole Motor Car Company, Indianapolis, Ind., has taken the three story building formerly occupied by the Reliable Auto Exchange and workmen are now engaged in transforming the structure into an annex of the automobile factory.

The Batesville Manufacturing Company, of Batesville, Miss., has just leased for a period of ten years a site at Newton, Miss., for the purpose of putting in a spoke factory, with a capacity of 10,000 spokes daily. W. M. Price will be general manager of the plant, and J. W. Griffin, superintendent.

Announcement is made that the Mutual Wheel Company, of Moline, Ill., is formulating plans, execution of which will result in greatly increased facilities for carrying on its growing business. The company has purchased a tract of ground in East Moline. A plant will be constructed on this land.

Crandall, Stone & Co., Binghamton, N. Y., will erect an addition of brick and concrete to the factory. This is to replace a building now used for japanning purposes and when the new structure is finished the present building will be torn down to make room for a much larger addition than to be erected.

The Moon Bros. Carriage Company, St. Louis, Mo., has purchased 310 feet on the west side of Second street at the north-west corner of Gano street. President J. C. Moon stated the company will hold the ground, which lies between the Wabash and the Terminal tracks, and may add to their present plant.

James H. Birch, carriage manufacturer of Burlington, N. J., has laid the foundation for a large building in the rear of his

buildings on Library street. The building will be three stories high, of corrugated iron, 150 feet in length by 40 feet in width. When completed the factory will employ a number of additional hands.

Hahn Bros., operating one of the largest carriage works in Hamburg, Pa., have recently made extensive improvements to their plant. They have enlarged every department of the works since the fire which destroyed parts of the buildings, which have since been rebuilt. Many improvements and conveniences have been installed. Machinery has been installed which will double the capacity of the old plant.

A lease was closed by the Kansas City (Mo.) Vehicle Company for a concrete and mill construction building to be erected at once at Tracy avenue and the Belt Line, at a cost of \$60,000.

The Moline Plow Company will rebuild the plant of one of its auxiliary concerns—the Mandt Wagon Company, at Stoughton, Wis. The estimated cost of the improvement is \$500,000. By following the method of building the new and then razing the old, the plant may continue in active operation throughout the period of reconstruction. Eight new buildings are provided for in the plans, including two warehouses.

FIRES.

The Henley Carriage Company, Lynchburg, Va., was a sufferer by fire. Loss slight.

Fire destroyed the plant of the DeWitte Vehicle Company at North Manchester, Ind. Loss \$12,000.

Keystone Vehicle Works, Reading, Pa., suffered a fire loss due to locomotive sparks, of \$3,000.

The Lebanon (Ky.) Carriage and Supply Company's store was destroyed by fire. Loss not given.

The carriage repair shop belonging to Hawkins & Goer, Birmingham, Ala., was destroyed completely.

Rome (Ga.) Buggy Co. was slightly damaged by fire communicated from another building. Loss covered.

The Lebanon (Ky.) Carriage and Implement Company was completely gutted, burning a great deal of the stock. T. A. Mattingly, proprietor of the company, was the heaviest loser, \$8,000 on stock, with \$3,000 insurance. The building belonged to J. M. Faulkner, of Louisville, whose loss is \$3,000, with insurance of \$1,000.

BUSINESS TROUBLES.

Receiver has been appointed for C. H. Lohnas, Saratoga Springs, N. Y., a carriage builder.

The Gregg Carriage Company, Philadelphia, Pa., obtained a foreign attachment against John Wesley Allison, with bail fixed at \$4,000.

Ex-Governor W. T. Durbin has been appointed the receiver for the Anderson Carriage Mfg. Co., of Anderson, Ind. Assets are said to be \$80,000 and liabilities about \$200,000.

The plant of the Ionia (Mich.) Wagon Works, which had been ordered sold by the court, was bought by T. B. Preston, of Ionia, for \$70,000, who represents the Hayes Ionia Auto Body Co., which will start the work of remodeling the plant for the manufacture of metal auto bodies. The company has a prosperous factory in Detroit.

The hearing of the complaint of the Springfield (Mo.) Wagon Company against the Frisco Railroad, which was to have been held at a meeting of the board of railroad and warehouse commissioners in St. Louis, has been postponed indefinitely. The wagon company is seeking to obtain a seventeen cent rate on shipments of steel from St. Louis to Springfield.

In the suit of Brandenburg & Co. against Receiver Coxé, the plaintiff sought to recover on a contract with the Keystone Wagon Works, Reading, Pa., 10 per cent. commission for wagons and auto bodies sold. Brandenburg & Co. alleged that Receiver Coxé of the Keystone Wagon Works was liable for the payment of the commission on orders placed by them prior to the receivership. The case was decided in favor of the receiver.

A. L. A. M. AND THE TIRE QUESTION.

Builders of automobiles and tire manufacturers met in conference at the headquarters of the Association of Licensed Automobile Manufacturers and after a full discussion of the tire question, decided that the situation, so far as it relates to the purchase and sale of tires, need not be so pessimistically considered as some recent reports would indicate. In fact, a more optimistic view can now be taken. The manufacturers of cars in America are not in the position where it is necessary for them at this time to contract for the next season's requirements of tires, and the rubber tire manufacturers seem to be able to handle the present situation along lines that are expected to be in favor of the car owner.

There seems to be an impression that it is necessary for car owners to purchase tires for future use, due to the feeling that there is to be an abnormal advance on this particular product in the near future. While some increase may be expected, car owners should understand the conditions of buying now, and be warned of the disadvantages that might occur in purchasing in advance of current needs. There is hardly any question that the saving at the present time will be largely offset by the deterioration in surplus tires and the passing of the guarantee period.

It was the opinion of the conference that the interests of all will be served by a normal attitude toward future requirements.

All the prominent tire makers were in conference, numbering ten or a dozen, while those representing the Association were: Albert L. Pope, chairman; L. H. Kittredge, S. D. Waldon, J. W. Gilson, Horace DeLisser, and Alfred Reeves, general manager.

TREATMENT OF PILLAR.

A firm fastening for a pillar is here shown, consisting of a clamp hinge, which is of the thumb-screw order. When oper-

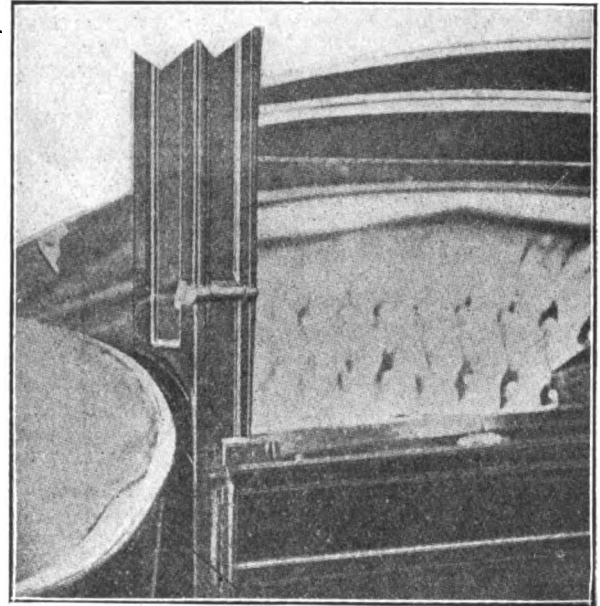

ated the pillar is firmly locked into position so as to prevent rattling of the front light.

SLATER NEGRO SCHOOL MAKES MODEST APPEAL.

Once more the Slater Industrial and State Normal School for Colored People at Winston, N. C., makes its appeal for donations, and suggests that an easy way for the average citizen to help is to slip a dollar bill in an envelope addressed to William A. Bair, treasurer, People's National Bank, Winston, N. C. One dollar now means \$4 for the school because of generous offers.

Recently Granted Carriage Patents

Whiffletree Hook. Thomas E. Ewer, Fort Des Moines, Iowa. No. 956,630. Patented May 3, 1910.

A whiffletree hook including a cuff composed of sections detachably interlocked, and a split ring having laterally separable members, one of which being integral with one of the sections

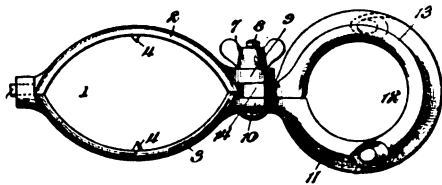

of the cuff and maintaining the split ring in spaced relation with cuff, and the other member being pivotally connected by a fastening device.

Spoke and Felly Clip. John Humphreys, Henderson, Ky. No. 956,806. Patented May 3, 1910.

A device comprising a spoke-engaging member having felly-engaging means for preventing the lateral movement of the spoke with respect to the felly, and a felly-engaging member comprising a base portion having its ends bent to form upstanding ears adapted to engage on either side of the felly and to be

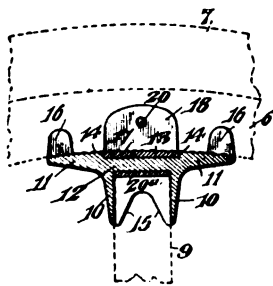

secured by a common fastening means, the last named member being interlocked with the first to prevent the longitudinal movement of the spoke along the felly.

Pneumatic Tire. Adrien Bonnet, Paris, France. No. 956,928.

A pneumatic tire, the combination of an inner tube, an outer tube cover for the inner tube, an inner tread-band of crescent-shaped cross-section and having a central annular groove in the outer face, the face of band being transversely curved adjacent to groove, an outer leather tread-band secured to and conform-

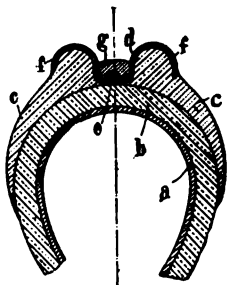

ing to the faces of groove and the curved face adjacent, and a circllet or ring having flattened inner, outer and side faces and fitting snugly in groove, the depth of which being much greater than that of circllet.

Thill-Coupling. Albert C. Schelle, Butte, Mont. No. 957,002. Patented May 3, 1910.

A thill coupling, a tie bar provided with a hook and with a thickened portion opposite the end of the hook, a locking hook having a thickened head and a relatively narrow portion adjoining the head, such locking hook co-operating with the hook first

mentioned, the hooks arranged to assume a position at right angles with each other and to engage and positively lock a thill iron, independently of other means, when the contracting portion of such thill iron is in substantially the same horizontal plane

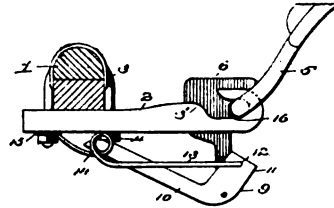

with the longitudinal axis of the tie bar and with the thickened portion of the locking hook, and means for preventing the displacement of the parts.

Demountable Wheel Rim. Harry J. Mortensen, Oakland, Cal. No. 957,080. Patented May 3, 1910.

The combination with a wheel, of a rim formed of a series of removably secured sections, a band circumscribing the rim

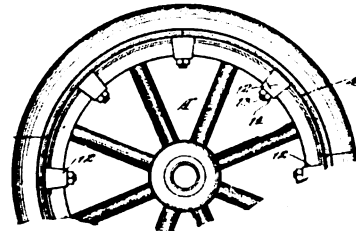

having one end secured to one of the sections and having the opposite end free, and means engaging the free end of the band for moving it and thereby constricting the band about the sections and holding the latter in interlocked position.

Thill Iron. Theodore H. Schlarmann, Breese, Ill. No. 957,107. Patented May 3, 1910.

A thill iron comprising a curved tubular member having a rounded portion provided with a closed end having a transversely formed eye, the member having its open end slitted longitudinally

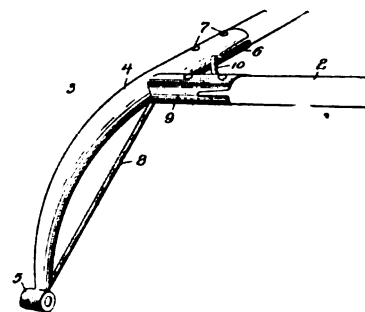

dinally at its opposite sides to provide compressible clamping portions, an integral truss brace member extending from the eye to the body of the tube, an integral transverse tubular socket member having its free end slitted at opposite sides to provide compressible clamping portions, and an integral brace connecting the socket with the outer end of the tubular member.

Wind Shield for Vehicles. Henry W. Bertram and Frank L. Lamoreaux, Detroit, Mich., assignors to Standard Auto Accessory Mfg. Co., Detroit, Mich. No. 957,541. Patented May 3, 1910.

A wind shield comprising a lower frame adapted to be rigidly secured in upright position on a vehicle, an upper frame corresponding to the lower frame, a pair of bracket arms extending forward from the upper corners of the lower frame, links pivoted

each at one end to the outer end of an arm and at the other to the upper frame between the corners, coupling bars each pivoted at its outer end to an arm between its lower corners and the link pivot, and a spring projected member on each coupling bar adapted to bear obliquely against the end of the upper frame

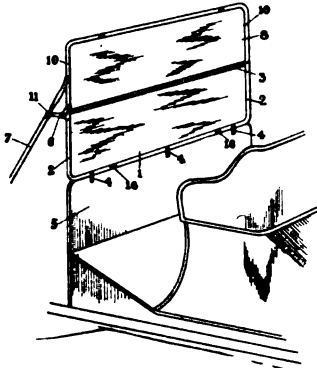

when it is aligned with and resting on the lower frame, the parts being disposed to lock the frames in vertical alignment one on the other and to move the upper frame into parallel relation with and against the lower frame when the upper frame is dropped.

Vehicle Wheel. Con D. Anderson, Lima, Ohio. No. 958,350. Patented May 17, 1910.

A device, an axle, a wheel having a ball-and-socket connection, and a member consisting of four arms integrally formed thereon

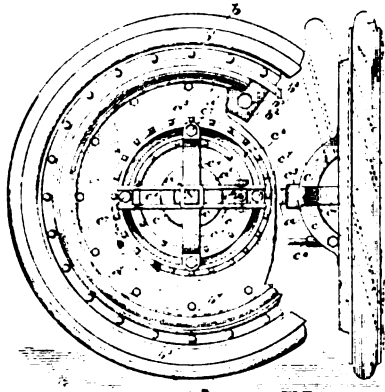

supported on axle and engaging wheel at diametrically opposite points, two of the arms being slotted to permit it to be moved with respect to axle in a horizontal plane.

Vehicle Body Structure. Edward H. Remde, Cleveland, Ohio, assignor to the Baker Motor Vehicle Company, Cleveland, Ohio. No. 858,940. Patented May 24, 1910.

A vehicle, the combination of a main body portion having an extension for supporting the battery, upright members contiguous to extension and a transverse member; a battery cover having permanently secured sides, top and outer end; and suit-

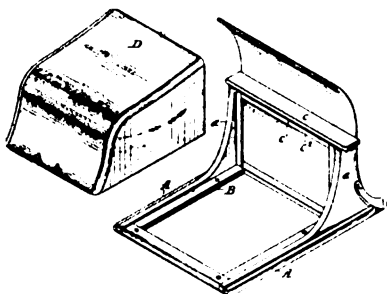

able means for securing said cover to the main body portion; the inner end of the cover being placed between the upright members and beneath transverse member.

Wheel Hub. Charles L. Johnson, Longville, La. No. 959,015. Patented May 24, 1910.

A wheel hub comprising a main and a cap section, spokes

fitted between the sections, the main section including a sleeve extending beneath the butt ends of spokes into cap section, a collar formed on the outer end of sleeve portion, the collar being provided with a series of openings formed therethrough, each of the openings including a threaded portion, a series of wedges each located between the butt end of a respective spoke and sleeve portion, each of the wedges being provided with a threaded recess, the threads in the collar and the recess being

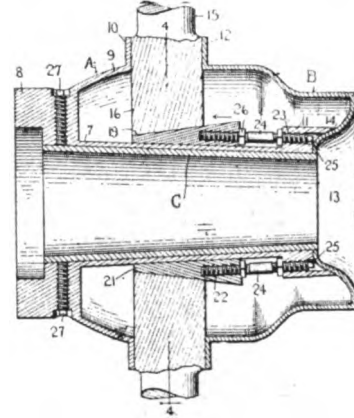

of opposite hand, screws held in the recesses of the wedges and the openings through the collar, the ends of the screws being threaded in opposite directions, lock-nuts held on each of the screws and adapted to engage against the collar and the end of the wedge to which the respective screw pertains and a key receiving end formed on the outer portion of each of the screws.

Vehicle Spring. Charles B. Geiger, Manning, S. C. No. 959,336. Patented May 24.

A shock-absorber for vehicles, the combination with an axle and body spring, of upper and lower plates fixedly secured to

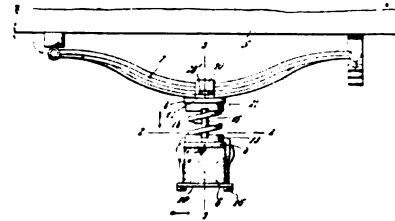

body spring and axle, helical springs interposed between plates and dished holders arranged on the opposite terminals of springs and bearing on plates, and tension rods passing through springs, plates and dished holders.

Wind Shield. Emile J. Montigny, New York, N. Y. No. 959,374. Patented May 24, 1910.

The combination of a dash board provided with a panel, a plurality of sashes journaled relatively to panel and disposed to fold side by side in planes parallel, one of the sashes having a

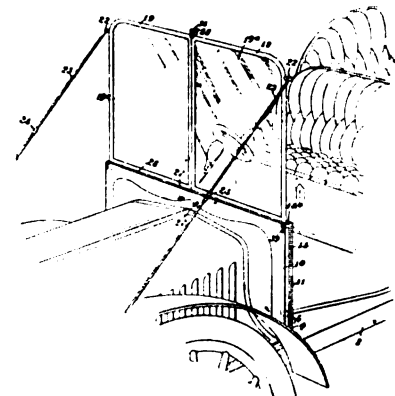

diagonal measurement greater than the width of panel, and a side panel journaled relatively thereto for the purpose of protecting the edges of sashes when the latter are folded.

RECENTLY GRANTED PATENTS OF INTEREST TO THE CARRIAGE INDUSTRY.

- 946,891—Wheel Bearing. Wm. H. Arnold, Oakland, Cal.
 946,791—Dump Wagon. Wm. Atkins, Auburn, N. Y.
 946,956—Whiffletree. Frank S. Burbee, Rock Glen, N. Y.
 917,193—End Gate for Wagons. Oscar A. Burull, Beloit, Wis.
 946,994—Draft Gear. Matthew Carr, Chicago, Ill.
 947,215—Wheel. Luther A. Caswell, assignor of one-half to G. Danner, Muncie, Ind.
 946,658—Foldable Vehicle Top. Alford L. Dallaire, Chicago, assignor to Studebaker Brothers Manufacturing Company, South Bend, Ind.
 946,672—Fifth Wheel for Wagons. John W. Haywood, Baldwinsville, N. Y.
 946,603—Coupling Yoke. John A. Jackson, assignor of one-half to D. L. Phipps, Chicago, Ill.
 946,638—Tire. David W. Jones, Taunton, Mass.
 947,105—Axle Box and Dust Guard. John D. Jones, Walla Walla, assignor of one-half to H. P. Howard, Fort Walla Walla, Wash.
 946,614—Vehicle Wheel. Robert J. Moore, Cincinnati, Ohio.
 946,981—Metal Cleat for Wagon Boxes. Orson O. Newberry, Argyle, Iowa.
 947,028—Seat-Securing Device for Wagons. Charles W. Rasmus, Mount Union, Iowa.
 946,869—Cushion Tire. Victor E. Rumbarger, Dayton, Ohio.
 947,203—Draft Equalizer. Dan Scheer, Madison, Neb.
 946,881—Spring support for Vehicle Bodies and Seats. Paul H. Schwartz, Big Sandy, Mont.
 947,371—Vehicle Tire. Leonard E. Clawson and F. L. Dow, San Francisco, Cal.
 947,676—Sled Brake. Harrison A. Denney, Reardan, Wash.
 947,628—Anti-Rattling Device for Brake-Bands. John Evans, assignor of one-half to C. Fitch, Utica, N. Y.
 947,543—Vehicle Tire. Harvey S. Firestone, assignor to Firestone Tire & Rubber Company, Akron, Ohio.
 947,442—Tire. Wm. D. Harris, assignor to Harris Tire & Rubber Co, Philadelphia, Pa.
 947,578—Power Tire Bolt Tightener and Cutter. Helmuth A. Krueger, assignor of one-half to G. H. Schelp, St. Louis.
 947,390—Spoke Socket. John Markwick, Scranton, Pa.
 947,683—Friction Brake and Clutch. Wm. C. Marsh, Dunkirk, N. Y.
 947,738—Buggy Top Support. Elijah McCoy, Carthage, Mo.
 947,564—Draft Equalizer. John N. Taylor, Durand, Ill.
 947,535—Cushion Tire for Vehicle Wheels. Carl Weichelt, Maricopa, Cal.
 947,318—Wagon Dumping Apparatus. George E. Wunder, Melvin, assignor to Independent Harvester Company, Plano, Illinois.
 948,267—Wheel Rim or Felly for Pneumatic or Solid Tires. Joseph B. Bradshaw, Manchester, England.
 948,042—Wheel of Vehicles. Harold E. Cherry, Burton-on-Trent, England.
 948,106—Vehicle Brake Lever. Joseph M. Custer, Copper Hill Virginia.
 948,090—Wagon Brake. Prieston Dickens, Fancy Gap, Va.
 947,806—Automobile. Thomas A. Edison, Llewellyn Park, Orange, N. J.
 947,893—Draft Equalizer. Wm. Elliott and R. H. Schlachter, assignors to Dempster Mill Manufacturing Company, Beatrice, Neb.
 948,092—Dumping Wagon. Earle E. Geeseman, Cuba, Ill.
 947,902—Loading Apparatus. Roy C. Glise, Prosper, Minn.
 947,815—Spring Wagon Bolster. John L. and A. Hagel, Dawson, Minn.
 947,824—Shifting Shafts for Vehicles. Warren A. Kitchen, New Market, Iowa.
 947,826—Spring Tire. Rudolph J. Lackner, New York, N. Y.
 948,246—Wagon Brake. Charles W. Page, Cathlamet, Wash.
 948,076—Vehicle Wheel. Oscar Schott, Cincinnati, Ohio
 948,064—Making Tire Shoes. Frank A. Seiberling and W. C. State, Akron, Ohio, said State assignor to said Seiberling.
 947,949—Buggy Boot Spring. Thad Sizer, Audubon, Iowa.
 948,193—Pneumatic Tire for Vehicles. Charles E. Titus, Springfield, Mass.
 948,408—Wheel. Thomas Berntson, Pittsburg, Pa.
 948,389—Tire for Wheels of Vehicles. John Cairns, Willenhall, South Staffs, England.
 948,780—Thill Tug. Wm. J. Campbell, assignor of one-half to R. L. Campbell, Dayton, Va.
 948,813—Removable Wheel Rim. John C. Cole, assignor to Fisk Rubber Company, Chicopee Falls, Mass.
 948,418—Automatic Brake for Vehicles. George W. Fisher, Western Run, Md.
 948,317—Motor Vehicle. Rudolphus Fuller, Detroit, Michigan.
 948,319—Whip Socket. Wm. H. Goldenstein and T. Voigt, Danforth, Ill.
 948,505—Wagon Seat Lock. Victor W. Heydlauff, Township One, Range One, Alberta, Canada.
 948,701—Pneumatic Tire. John G. A. Kitchen, Lancaster, and I. H. Storey, Ambleside, England.
 948,767—Sulky. Henry J. Miller, North Paterson, N. J.
 948,337—Vehicle Washer, Edward Muller, Weehawken, N. J.
 948,651—Sled Brake. Warren Nichols, Deerhead, N. Y.
 948,903—Pneumatic Tire. Wallace Odell, Tarrytown, N. Y.
 948,637—Tire Setter. Wm. Schau, Kalamazoo, Mich.
 948,638—Tire Tightener or Tire Setter. Wm. Schau, Kalamazoo, Michigan.
 948,829—Fifth Wheel for Automobiles. Joseph J. Scheib, Pittsburgh, and J. G. Garbart, Ingram, Pa.
 948,527—Whiffletree Hook. Peter H. Skavlen, Cedar Vale, Kas.
 948,354—Whiffletree Hook, Jaros M. Tappan, Luther, Michigan.
 948,487—Evener-Coupling. George F. Thompson, Minneapolis, Minn.
 948,358—Dump Wagon. Walter A. Underhill, Auburn, N. Y.
 948,749—Driving Mechanism for Vehicles. James F. Waite, Cleveland, Ohio.
 948,621—Vehicle Wheel. Eli S. Williamson, Buffalo, N. Y.
 949,561—Tire Tool. Stephen Alley, Westminster, London, Eng.
 949,670—Axle Lubricator. Lloyd L. Arnold, North Tazewell, Va
 949,169—Sled. Henry B. Bartelsen, Milwaukee, Wis.
 949,112—Vehicle Spring. Door R. Close, Chicago, Ill.
 949,113—Anti-Skidding Device. James F. Cooper, Petaluma, California.
 949,060—Vehicle Tire. Wm. J. Courtney, New York, N. Y.
 949,566—Wagon End-gate. George W. Edson, Guthrie Center, Iowa.
 949,174—Whiffletree. Louis E. Feinstein, Zeeland, N. D.
 949,175—Thill Strap Fastener. Riley C. Fetzer, assignor to T. E. George, Wooster, Ohio.
 949,422—Automobile. John E. Gable, Evanston, Ill.
 949,179—Driving Axle. Royal H. Gilbert, Lakewood, Ohio.
 949,472—Pneumatic Tire. Wm. M. Harley, assignor to J. Weerts, St. Louis, Mo.
 949,652—Vehicle Brake. Joseph H. Hotchkiss and A. P. Lane, Denver, Colo.
 949,654—Shock Absorber. Wm. B. Knapp, Stoneham, Mass.
 949,375—Vehicle Tire. Wm. A. Koneman, Cudahy, Wis.
 949,001—Resilient Tire. Emile B. Merigoux, Paris, France.
 949,590—Wagon Bolster. Wm. B. Milligan, Monticello, Ill.
 949,636—Vehicle Wheel. John C. Rutherford, assignor to Iron Tire Pneumatic Wheel Company, New York, N. Y.
 949,663—Tire Tightener. George A. Ryan, Amarillo, Texas.
 949,308—Vehicle Spring. Wm. H. Smith and J. H. Klassen, Los Angeles, Cal.
 949,556—Whiffletree Hook. Wm. M. Wadleigh, Chicago, Ill.
 949,097—Motor Control System. Emmett W. Stull, Norwood, Ohio, assignor to Allis-Chalmers Company.

Copies of above patents may be obtained for fifteen cents each, by addressing John A. Saul, solicitor of patents, Fendall Building, Washington, D. C.

RECENTLY EXPIRED PATENTS OF INTEREST TO THE VEHICLE INDUSTRY.

Patents Expired April 18, 1910.

- 495,489—Vehicle Spring. Joseph Henrie, Benton, Kansas.
 495,544—Vehicle Gear. Adniram J. Cook, Troy, N. Y.
 495,707—Vehicle Hub. Paul F. Rachal, Fort Jesup, La.
 495,708—Dumping Wagon. John T. Richardson, Harrisburg, Pa.
 495,743—Vehicle. Charles C. Leiwienich, Chicago, Ill.
 495,817—Wheel for Vehicles. Marcus W. Lowinsky, London, England.

Patents Expired April 25, 1910.

- 495,993—Automatic Wagon Brake. James M. McConnell and Martin L. Carlisle, Anderson, S. C.
 496,048—Dumping Wagon. John N. Ericson, Chicago, Ill.
 496,226—Wheel for Vehicles. Giles T. Jobson, Augusta, Ga.

Patents Expired May 2, 1910.

- 496,418—Vehicle Tire. Woodburn Langmuir, Toronto, Canada.
 496,633—Metal Wheel and Method of Making Same. Joseph W. Bettendorf, Springfield, Ohio.
 496,704—Vehicle Hub. Milton B. Southerland, Linden, Tenn.

The above lists of patents, trade marks and designs of interest to our patrons are furnished by Davis & Davis, solicitors of American and foreign patents, Washington, D. C., and St. Paul Building, New York City.

WHAT HOLDS THE WHEEL UP?

Is Load Suspended from Top of Tire or Supported by the Bottom?

Mr. Thomas S. White in the April Motor, to whose courtesy we are obliged for article and illustrations, takes up and closes a discussion on the load suspension of tires that should have more than a curious interest for carriage builders who are facing motor car problems:

There seems to be a general agreement among all parties to the tire controversy that, when a wheel fitted with pneumatic tires supports a vehicle, the weight of the vehicle acting downward through the rim and the reaction of the roadway acting

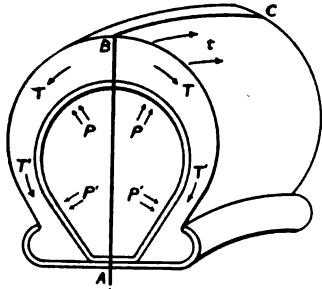

Fig. 1.

upward at the ground contact of the tire are two equal and opposite forces which must necessarily balance each other. The undecided question then is this: Since the rim and the roadway do not meet, how is the stress which exists between them transmitted?

The ordinary view, upheld by Mr. Towle, is that the rim rests on and is supported by the cushion of air beneath it, this in turn resting on and being supported by the roadway.

The view held by Dr. Samways is: (1) That the rim is not supported by the air below it at all; (2) but is suspended by the tire fabric from the arch of the upper portion of the tire; and (3) that it is between the arch of the upper portion of the tire and the roadway and not directly between the lower part of the rim and the roadway that the compressed air in the tire functions as a link in the transmission to the roadway of the load imposed on the rim.

The distribution of strains and stresses in a loaded wheel and tire is evidently such that a section in the plane of the wheel through its center of gravity can be taken as a plane of symmetry in which the resultants of all pressures and tensions entering into the support of the rim may be considered to act. Thus, in

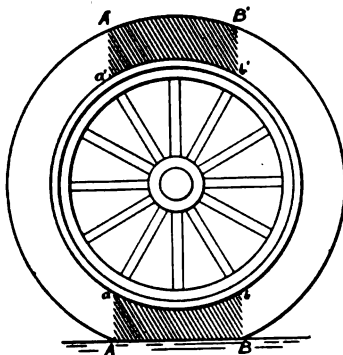

Fig. 2.

Fig 1, which represents a segment of a tire and rim, the resultants of all tensions T , T or $T1$, $T1$ perpendicular the circumference of the rim, the resultants of all tensions t , t parallel to the circumference of the rim, and the resultants of all pressures p , p or pl , pl lie in the plane of $A B C$, which is the plane in question. Hence, in the sequel, when tensions are spoken of as acting in the plane of symmetry, when they really act in the fabric of the tire, the resultants are referred to. And similarly, in the case of pressures, it is the single pressure to which they are equivalent that is indicated.

Fig. 2 represents a section in this medial plane of a wheel fitted with a clincher tire which is supporting a load. AB is the ground contact. The fabric of the tire is supposed to be flexible, that is capable of transmitting a tension in its own plane but not a pressure. It will simplify matters if we consider the tire to be weightless. If not, its weight is clearly supported by the upward thrust of the air in the tire acting on the arch of its upper segment. However, neglecting the weight of the tire, we have the weight of the rim and vehicle acting downward and the reaction of the ground along AB acting upward, and these two forces balance.

Referring to Fig 2, it is clear that the whole pressure transmitted by the air cushion $AabB$ from the ground to the rim depends on the pressure in the shaded region below the rim and on the length or the arc ab , the latter in turn being determined by the length of the ground contact AB . But these two quantities are the same for the region $A^1a^1b^1B^1$ above the rim. Therefore, whatever thrust the air cushion $AabB$ transmits from the ground to the rim is retransmitted by the air cushion $A^1a^1b^1B^1$ from the rim to the crown of the tire. Or, to view the same fact a little differently, the rim is balanced between the two equal and opposite pressures exerted respectively by the two similar cushions $AabB$ and $A^1a^1b^1B^1$. How then can the action of one of these cushions balance the weight of the rim and vehicle if it is neutralized by the action of the other?

But is it a fact that the relaxation of the tire fabric in the lower shaded region induces an unbalanced upward airthrust? In the first place, strictly speaking, the rim, if it were supported from below at all, would rest not on the cushion $ABba$ particu-

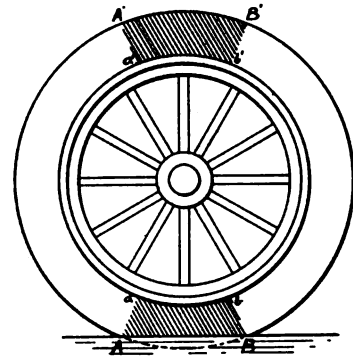

Fig. 3.

larly, but on the whole body of compressed air in the lower half of the tire. Further, the upward thrust on the rim, due to the pressure of the air below, is, when the wheel is unloaded, balanced by the tensions of the whole of the lower half of the tire. When the weight is applied, the relaxation of the tension in the shaded area must therefore be deducted from the whole tension in action when the wheel is unloaded, and must not be considered as if it were an isolated force. This is important because the whole force of the radial tension acting on the lower half of the rim is much greater than is necessary to balance the whole thrust the latter receives from the air around it, so that even when the total radial tension pulling downward has been diminished by the relaxation at the ground contact, sufficient down-pull is left to still neutralize the whole upward push of the air on the rim. And if, when the wheel is loaded, the upward thrust of the air below the rim still remains balanced by the radial tensions, the pressure of the air clearly cannot be considered, as supporting the load.

In Fig. 3, if the wheel carries no load, the downward pull of the tire fabric $ABba$ on the rim is balanced by the upward pull of the tire fabric $A^1B^1b^1a^1$. When the wheel is loaded the upward pressure of the roadway relieves the tension of the tire fabric $ABba$ and the magnitude of the downward force thus taken off the rim is, as Mr. Towle points out, equal to the whole weight carried. This leaves unbalanced the tension of the fabric $A^1B^1b^1a^1$ acting upward on the rim with a force also equal to the total weight. But the weight of the rim and its load is meanwhile acting downward with nothing to support it. There-

fore the tension in the fabric $A^1B^1b^1a^1$, which would otherwise be unbalanced, takes up the weight of the rim and load which would otherwise remain unsupported. Thus the thrust of the roadway perpendicular to AB is transmitted as a thrust to the arch of the upper half of the tire and thence as a tension in the tire fabric to the rim.

There is one way of looking at the matter which shows at once, without analysis, that the weight of a loaded rim is not directly supported by the air cushion between the rim and the

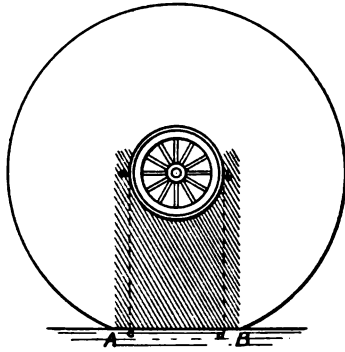

Fig. 4.

roadway. As Mr. Towle rightly remarks, "If the theory is correct, obviously the precise shape of the tire has nothing to do with the result," so let us consider the case of a wheel of which the rim is comparatively small, supported by a tire of which the section is comparatively large. Such a construction is illustrated in Fig. 4, and, while it is not likely that such a tire would ever be adopted in practice, still it is a possible model. Its peculiarity is that the length of the ground contact AB is greater than the rim. Now, if, as Mr. Towle maintains, the loaded rim is supported by the pressure of the air underneath it, it must rest on the cushion $abcd$. Therefore the whole load is equal to the pressure on AB . Therefore the lesser is equal to the greater—an absurd conclusion which shows that the assumption that the weight of the rim and its load is supported by the cushion below it is untenable.

From a mathematical point of view, the manner in which a pneumatic tire supports the rim is most directly deducible from the principle of virtual velocities. When the tire has its confor-

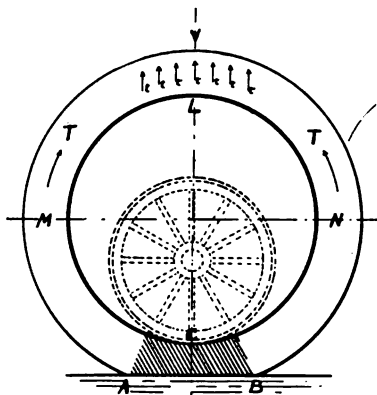

Fig. 6.

mation under load, as in Fig. 2 or Fig. 3, and the rim is then conceived to receive a small imaginary vertical displacement, the net work done by all forces acting on the rim must be zero. We therefore have: $Pdx + Wdx + T^1dx - Pdx - Tdx = 0$, where dx is the vertical displacement, W the weight of the rim and load, T^1 the downward resultant tension in the fabric below the rim, T the upward resultant tension in the fabric above the rim, and P the vertical thrust of the air either above or below the rim. We therefore have by simplifying: $T - T^1 = W$, or the weight is supported by the excess of the upward tension in the upper part of the tire fabric over the downward tension in its lower part. In this result it should be noticed that the air pressures are eliminated without any regard to whether they are transmitted

through the rim or tire fabric so as to form a system in equilibrium among themselves, or are considered as separately neutralized by the upward and downward components of the tensions.

While we have so far confined our attention to the clincher tire, as representing the type in general use, the truth that the weight of the rim and vehicle is suspended from above by a tension and not supported from below as by air pressure is one of universal application.

The general philosophy of what invariably happens is something like this: When a wheel is unloaded the pressures and tensions are a dual system in equilibrium, a tension at one side of the rim being balanced by a tension at the other side of the rim and the same with the pressures. Now, when we impose a load, what is changed in the stress plan is not a pressure but a tension. Therefore the corresponding tension becomes unpaired and it is this which the weight takes up.

In Fig. 6 is illustrated in an exaggerated way a loaded rim fitted with a loose single tube tire. The inner ring of the tire shown as $LMCN$ is clearly in a state of tension, for upon it falls the duty of balancing the excess radial tension in the tire walls due to the pressure outward on the circle VBA being greater than the pressure inward on the circle $LMCN$. When the downward tension of the tire fabric in the shaded region is relieved by the compression of the tire along AB , part of the upward tension in the ring $LMCN$ becomes unbalanced, and just as in the cases which we have already considered, the unbalanced pull upward and the unbalanced weight downward balance each other. That the rim is not supported by the air pressure can be shown here also by making the ring $LMCN$ so small that it lacks sufficient area to support the weight, and the proof by virtual velocities is also valid. The inner ring of the tire acts as a sort of sling in which the rim is hung, and remembering what was previously said about the medial plane being a plane of symmetry, the stress between the weight and the reaction of the

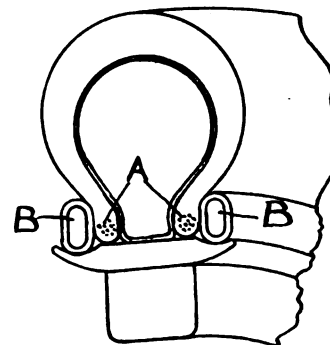

Fig. 7.

roadway may be analyzed as a tension in the circle $LMCN$, which is continued as t, t, t , the last being balanced by the thrust of the roadway transmitted as pressure.

To come to the case of the Dunlop tire in which there is supposed to be no friction between the beads AA and the rim flanges BB , Fig. 7, Mr. Towle asks "Would the mere removal of the frictional grip cause such a tire to flatten completely at the ground? Obviously not. And yet how would such a rim be suspended?" The answer of course is: By the beads AA . For if we apply to them the reasoning which has just been applied to the circle $LMCN$ in Fig. 6, this is the conclusion we should arrive at, the argument being the same step by step in the two cases.

The case of the single tube tire illustrated in Fig. 6 was recently made the subject of a practical test. A brake shoe was used to replace the rim shown and on it was placed a load of 150 pounds, the single tube tire being represented by a $34 \times 4\frac{1}{2}$ inch inner tube, inflated to a pressure of approximately 25 pounds to the square inch. The positions of the points L, M, N were carefully marked and the length of the lines MN and LC measured both before and after the weight was put on the brake shoe. It was found that under conditions of load the distance MN increased 9-16 inch at each end, but in spite of the lowering effect

on the crown of the tube due to this spreading action, the length LC was increased by $\frac{1}{2}$ inch. The thrust from the ground contact to the arch of the tire was in this way rendered very palpable.

PRESENT STATUS OF SELDEN PATENT LITIGATION.

Litigation under the basic Selden patent has progressed rapidly recently. The present status of the matter is about as follows:

The original suits filed on behalf of the A. L. A. M. companies against seven unlicensed manufacturers in the Federal Court at Detroit have been supplemented by a similar action in that court against the Imperial Automobile Company, of Jackson, Mich., and by suits against the Paterson Company, of Flint, and the Flint Wagon Works, both of which were commenced in the Northern Division of the Eastern District of Michigan.

Service was had upon each of the defendant companies and leave to plead was granted. The Columbia Motor Car Company and George B. Selden are plaintiffs of record in each suit.

Similar litigation was also commenced against the Parry Automobile Company of Indianapolis.

The complaints in all the suits allege that the defendant companies are infringing the patent, involving the principle of compression gasoline engines applied to the propulsion of carriages.

The defendants in Detroit and elsewhere announce that they will fight the cases to ultimate decisions and in a series of conferences tentative plans of action have been discussed. The Abbott Motor Company has taken a decided stand in the matter and several of the other defendants have gone over the situation with the Abbott Company's officers with a view to concerted action.

The Abbott Company gave out a statement a few days ago in which it was stated that the company does not believe in the validity of the Selden patent. The fact was alleged that while the matter had been litigation for seven years, no final decision had been reached in the courts supporting the claims of the Selden advocates.

The suit of the Electric Vehicle Company, et al, against the Ford Motor Car Company et al., which is pending before Judge Hough of the Federal Circuit Court of New York, progressed another step towards a final decision within the past week. The plaintiff prevailed at the hearing last fall and the present action is for the purpose of substituting the Columbia Motor Car Company as plaintiff in place of the Electric Vehicle Company, which it has succeeded.

A motion was made for leave to file a bill embodying such a substitution and after argument Judge Hough ruled in favor of the motion. The bill was accordingly filed and subsequent proceedings will follow in course.

In the meantime, the situation has been complicated to a certain extent by the filing of a suit against the various companies making up the A. L. A. M., on behalf of the Velie Motor Vehicle Company, of Moline, Ill. This action was commenced in the Federal Circuit Court at Milwaukee and demands \$500,000 as damages.

The bill of complaint sets up ten different causes of action or counts. The first of these alleges that the A. L. A. M. is an unlawful combination in restraint of trade within the purview of the Sherman act.

Second.—That the A. L. A. M. notified the plaintiff to enter the combination, demanding \$17,000, and restricting the output of the company to 2,500 cars in 1910.

Third. That when the plaintiff declined to enter the combination, the defendants threatened to injure the business of the plaintiff.

Fourth.—That the defendants conspired to prevent plaintiff from purchasing materials.

Fifth.—That they conspired to prevent proper advertising of plaintiff's output.

Sixth.—That the defendants through conspiracy prevented the

Kopmeier Motor Company, agent of the plaintiff in Milwaukee from exhibiting the Velie car at the show in Milwaukee last winter.

Seventh.—That a New York advertising agency had informed the plaintiff that it could not handle the advertising of the Velie company because it would lose business of \$75,000 a year by so doing.

Eighth.—That the A. L. A. M. in pursuance of the alleged conspiracy endeavored to prevent the extension of credits at banks.

Ninth.—That the defendants have conspired to prevent prospective purchasers from buying Velie cars.

Tenth.—That they have tried to get contract customers to break the terms of their contracts with plaintiff.

Service in this action has not yet been made upon the A. L. A. M., but it is expected shortly. Alfred Reeves, general manager of the association returned recently from the West. He made no statement with regard to defense.—The Automobile.

NEWS OF THE A. L. A. M.

At the board meeting of the Association of Licensed Automobile Manufacturers, which was held at the New York headquarters, there was a long discussion on the tire situation. Almost the entire membership was represented, and it was voted to place the matter in the hands of the tire committee, of which Albert L. Pope is chairman. There were three additional members appointed on the committee.

S. M. Butler attended the meeting in behalf of the Contest Board of the A. A. A. He told of the racing situation and of the need for co-operation on the part of the manufacturers in order to insure absolutely fair contests.

Howard E. Coffin, president of the Society of Automobile Engineers, addressed the meeting on the plans of the society, having in view the standardization and general advancement of motor car building. Mr. C. F. Clarkson, formerly assistant general manager of the Licensed Association, has been made secretary of the engineering society.

The other business transacted at the meeting was of a routine nature. Mr. Charles Clifton, the president, presided.

One of the pioneers in the dry disc clutch field is the F. B. Stearns Company. Under the direction of Mr. Stearns the dry clutch has been brought to a high state of perfection. For over two years the experimental cars of the Stearns factory have been using the new clutch, trying it on the hills, in mud, sand, and submitting it to every possible test.

When, after months of experimenting, it was found that the clutch was perfect in operation, it was installed in Stearns models.

The Stearns dry disc clutch is built complete in the factory, and is designed particularly for the 15-30 h. p. and 30-60 h. p. chasses. In the former model it consists of fourteen plates, five driven, of saw steel, and nine driving, of a special fabric. Exhaustive tests have proven that the asbestos fabric used will not burn or wear away. The engagement is always positive, and there is no opportunity for the clutch to slip. Six coil springs take care of the adjustment, and it is a matter of but a few moments to tighten or loosen them. Inasmuch as there is no lubricant to apply, the dry disc clutch requires practically no care or thought. In the larger clutch there are six driving and twelve driven discs.

CINCINNATI CARRIAGE MAKERS' OUTING.

The annual outing of the Carriage Makers' Club of Cincinnati was held Saturday, June 4, at the Laughery Club. A baseball game, races and other sports were indulged in and a famous Laughery dinner served at the clubhouse.

Referees have been appointed by the court to determine the rights as between J. H. Hastings and the Delmar Buggy Hardware Co., all of Wilmington, Del.

THE GARAGE REPAIR SHOP.

Bearings in motor vehicles may be called the vital parts of the mechanism required to support the machinery of the car. On the performance of the bearings depend the main operating factors of the modern automobile, as is already quite well known to the profession. Many a good car has been abandoned early in the game due to a defective bearing, or a bearing which has been neglected. Hence one of the essential elements in the work of modern garage repair institution concerns the bearings or journals of the motor car.

First of all, we have to have steadiness and evenness of movement in the bearing. Endurance is another factor in the high-speed machines. Reduction of the frictional contacting surfaces is another point requiring attention. Then again, freedom

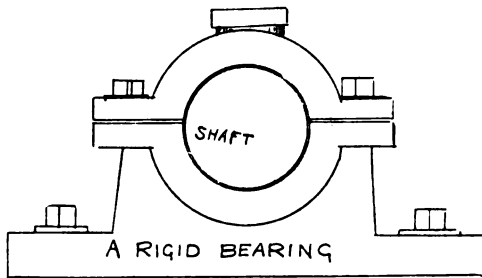

Fig 1

of lubrication must be considered. The bearing should be securely fastened to its seat.

The bearing of the up-to-date automobile cannot be too weighty. The bearings can be separated into classes. There are the common rotary bearings, reciprocating bearings and radial bearings. Of course the ordinary types of cylindrical bearings are the chief kind used in automobile service. These are classed under various heads of ball and roller bearings. In the cylindrical or rotary bearing, the surfaces all move at an even velocity. In the flat or parallel surface bearings there is the reciprocating movement which has to be carefully arranged for to avoid undue friction and unnecessary motions. Then there are the bearings which have varied velocities, according to the distance from the center. There are pivot-bearings, cone-bearings, and other styles found in service for special work in automobile machinery.

Alloys for motor vehicle bearings include copper, tin, lead, zinc and antimony. There are machine bearings for the cars made of hard brass, gun metal, babbitt metal, hard white metal, low grade lining metal, etc. In fact, a very wide range of tough metals are used for this service in addition to the fine types of steel descriptions.

Figure 1 is a cut of one of the forms of rigid bearings. A diagonal pedestal bearing is shown in Figure 2. These forms

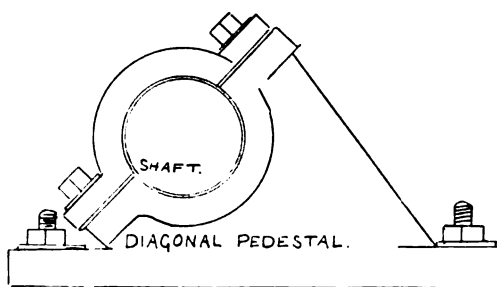

Fig 2

of bearings are employed where there is a diagonal thrust motion. These bearings are seldom made according to any defined pattern. Considerable care is needed to create the contour and curves necessary to bring about the desired results for the shaft.

An open frame bearing is shown in figure 3. The sockets in this style of bearing require a loose fit. The bolts for holding down the cap should not be excessively tight. Freedom of re-

volving space for the spindle in the box is required in order to get best results from the open frame bearing.

Referring briefly to ball bearings, these, of course, are the mainstay of the average motor vehicle. Both the ball bearings and the roller bearings arranged under varied circumstances are extensively utilized in all kinds of automobile work and the employes of the garage repair shop have to be well acquainted with the details of the bearings.

I have seen cases in which green men have ruined the ball bearing adjustment by incorrect setting by a simple turn of a

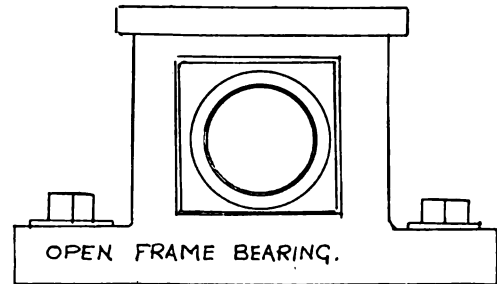

Fig 3

set screw. For instance, a certain car was run into a shop for repairs. The trouble was in the bearings. Figure 4 shows the correct alignment of the cone, groove and balls of the rotary type of ball bearing used in automobile service for shafts. A line drawn straight down through the cups, the balls and the cone would show that these parts were in true alignment. A line drawn down through the same parts in the adjustment shown in the figure 5 would show that everything was out of line. The bearing in the machine in the shop was in the fix shown in figure 5.

The repairman did not quite understand the condition of things and he proceeded to do some tinkering on the engine

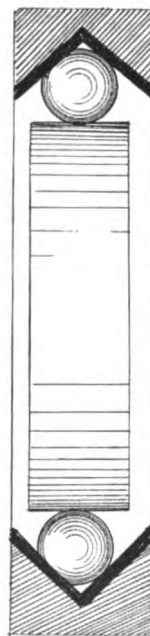

Fig 4

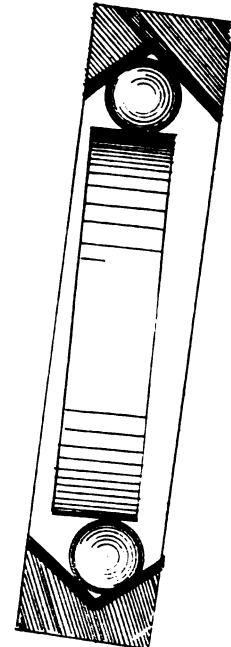

Fig 5

at first. He got that out of order and then he called in the boss and the boss being a man of more experience proceeded on a different line. He got the engine back into working condition and then commenced a series of tests of the machine by the "feel" method.

After a man gets well accustomed to fixing automobiles, he can "feel" a defect in any part of the machine by placing his hand on it while it is running. A good locomotive engineer can do the same with his engine. Therefore the garage boss got on to the defective bearing and quickly set things to rights by

first adjusting the case correctly, following up with a new set of parts, as the old parts were worn badly, thereby allowing the bearing to tilt out of line as in the illustration.

In some of the ball bearings there are spiral springs placed between the balls as shown in figure 6. These springs wear and break in time, although they are first class to have, and in fact a very good idea is to use them. But like all works of man, certain conditions cause metals to wear and break as the years

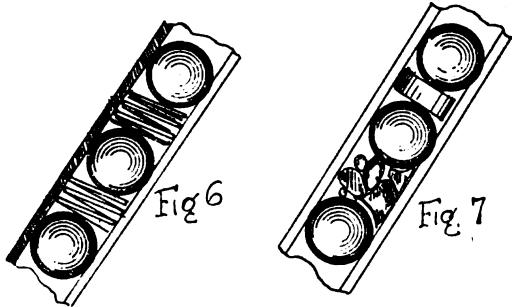

pass, so that new parts are needed. The automobile builders do not calculate that their machinery will last forever. Hence it is not remarkable to find worn and broken springs occasionally. In the event of such happening, new springs can be replaced readily.

Sometimes the balls are in the shape shown in figure 7, due to the wearing and breaking up of one or more of the steel balls or disks used in the combination. I would overhaul the bearings of my machine occasionally and see to it that all worn and cracked parts are replaced by new parts. The bearings should be washed out two or three times each season and new oil put in.

MOTOR CAR REPAIRS.

This is a subject that will grow in importance to the carriage builder who makes a feature of repairing. There will be plenty of such work, and it will be very profitable work. There may not be, as yet, as complete a knowledge of the subject among repairers as is necessary, so the following observations from American Blacksmith possess value, and should be considered:

It is but natural that the forward part of a motor car should meet with more accidents than the rear half. A solid obstruction can bring the steering gear, radiator, front axle and wheels to grief very quickly. The smith will probably be called upon to make repairs to these parts of the car more than to any other, and the majority of the jobs of this character to be done are right along his line and would require the services of a smith, even though a garage and repair shop was at hand.

Frames are built of I-beam steel, while others are of tubular construction. The majority of heavy cars employ an I-beam front axle with the center dropped, while the lighter automobiles use a straight tubular axle. In a smash-up it will be the front axle which suffers most. When removed from the car, a good smith can repair this in short order, the only implements necessary being a good forge fire and a sledge hammer. Nearly all kinds can be straightened, when hot, by a few well-directed blows of the sledge hammer, and if allowed to cool slowly they will not be injured in the least. The buggy kind of automobile is about the only kind that uses the ordinary fifth wheel for steering. All of the others employ a stationary front axle with an independent knuckle on each end on which the wheel is mounted. A bend in the end of the axle will throw one of the other of the wheels out of the proper vertical line and will interfere with the steering of the car. The best way to straighten this is to heat the axle near the yoke and to insert a heavy bar of iron in the holes of the yoke. If the axle is held rigidly in place and sufficient pull is exerted upon the rod acting as a lever, the yoke may be brought to the proper position with regard to the axle. It will probably be necessary to hold the axle level, with the yokes in their ordinary position, and to then drop a plumb line through the holes to make certain that they line up properly.

The front wheels do not lie in absolutely vertical planes which are parallel to each other, but dish. With the average motor car the bottom of each front wheel should slant in about three inches from a vertical line made by dropping a plum-bob from the upper rim. It will be observed that the way to obtain this proper slant to each wheel is to use the bar in the yoke.

To remove axle from car loosen nuts from the clips. If these nuts have been riveted on, the ends of the spring clips must be ground off with a file or small electric emery wheel. Of course, it is well to take every precaution against any of these nuts becoming loose and jarring off, but a lock washer or extra nut on each clip will serve the purpose equally well. The extra nuts probably hold the others in place better than anything else.

If power for electric lighting is obtainable, a small, portable electric motor is one of the most valuable tools available for loosening spring clips and the like on the under side of the car. The plug, to which is attached the flexible electric wire, may be screwed in any lamp socket, and by means of various kinds of emery wheels attached directly to the spindle of the motor a variety of filing and grinding jobs may be performed easily.

One of the parts of a car most liable to suffer damage in case of a smash-up is the radiator. If the fracture is small it may be repaired temporarily by means of soap or putty applied to the outside and allowed to harden. This is but a makeshift repair, and the radiator should be soldered as soon as possible in every leaking joint or opening. If car from which all the cooling water has leaked is brought into the shop under its own power the motor should be allowed to cool thoroughly before the radiator is again filled. If this precaution is not heeded the cool water coming in contact with the hot cylinder may crack the walls and absolutely ruin the motor. If it is desired to find the leak immediately, thin oil may be poured into the radiator with no attendant danger of cracking the cylinder walls, but in this case great care should be taken to make certain that the engine is not sufficiently hot to set fire to the oil. This is almost certain to happen if the motor has been running for a time after the circulating water has entirely leaked from the radiator.

Sometimes a car may be ditched, or overturned, and the frame may have been distorted or twisted sufficiently to throw the motor out of line with the transmission or clutch shaft, thus causing a lateral strain on the crank shaft, which will soon heat the bearings. Whether the frame has been twisted or not may be determined easily by uncoupling the joint between the rear end of the crank shaft and the clutch—if these parts are separate—or between the clutch and transmission shaft if part of the clutch is integral with the crankshaft of the motor. Universal joints will probably be found at all of these places, but even when using these the main shaft of the transmission and the crank shaft of the motor should lie in the same straight line—unless the car is of the type having its transmission located near the rear axle. The motor should also be lined up if it has been removed from the frame. It is true that the universal joints will allow power to be transmitted from an angle, but when used in the places in question they are to take care of any flexibility of the main or sub-frame caused by the car moving rapidly over rough roads and should be called into service as little as possible. If the crank shaft and transmission shaft are aligned perfectly there will be no power lost in the universal joints, and these will only serve to make the whole frame of the car more flexible and better adapted for all kinds of running.

If the forward half of the main frame or the sub-frame—which is sometimes used to support the motor—should be found to be twisted or warped only enough to throw the crank and transmission shafts out of alignment by but a fraction of an inch it will not be necessary to straighten the frame itself. In this case the motor may be brought to its proper position in relation to the transmission by the use of a few thin washers between the lugs of the motor and the sides of the frame on which the engine rests. By properly placing these thin washers under the front or rear lugs the end of the crank shaft may be raised or lowered a slight amount.

ARRANGEMENT OF HOOD BOWS.

Since the introduction of cape hoods for motor cars, quite a number of different devices have been introduced for fitting an extension on the front bow, which, while projecting well forward when in use, will lie back snugly and uniformly with the others when not in use. Some of them are very ingenious and are often complicated. The accompanying illustrations explain one recently introduced, which, while being as effective as any other, has the merit of simplicity; the fittings can all be made in any shop. In general principles it does not differ from the ordinary cape hood, and attention is more particularly directed

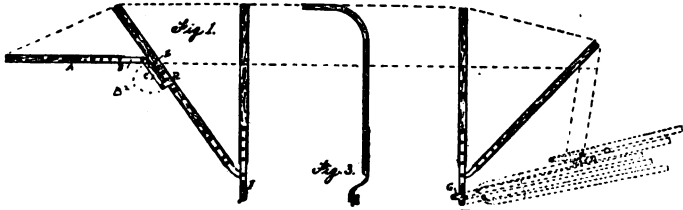

to the method of attaching and swinging the horizontal bow A (Fig. 1). The connection consists of three flat plates, B, C and D, made from $\frac{3}{4}$ in. and 3-16 in. steel, and the stop E. When in use it is as shown in Fig. 1; in folding, the middle piece is swung round in the direction indicated in B2, until it lies along the bow. This provides for the shortening of the horizontal bow necessary to enable it to fold uniformly with the others when down. The finger plates are all made from $\frac{3}{4}$ in. and 3-16 in. steel, cut off square, without tapered ends, and screwed outside the bows. They should be vised up with all sharp edges removed, and may be either brass or silver plated. They are set outwards about 4 in. as shown, Fig. 3. The finger plate F has pin welded in, which fits into hole to correspond in G, F and G fit on goosenecks attached to sides of front and rear seats respectively, but, before dropping hood, F is transferred to G, where it is held securely by a butterfly nut.

For a cape hood, the bows should be about 1 in. x $1\frac{1}{4}$ in. These are covered with a special motor top canvas, without lining. In place of welding for spacing the bows, two folded bands are made from the covering materials. A piece of $\frac{3}{8}$ in. silver or brass beading is brought well around the bend of the bow over canvas on each side. To allow for free movement of horizontal bow A, material is secured only in front and round bend, the sides being left free. This hood is stayed to front of chassis in the usual manner, by two leather straps, from horizontal bows A.

VERY PRETTY AND EFFECTIVE.

A poster in colors is being distributed by the B. F. Goodrich Co., Akron, Ohio, that is most pleasing.

The subject depicts the body of a rubber-tired hansom (Goodrich, of course, and a "hansom" girl in the act of entering the vehicle. The Goodrich people have a fine taste for pretty girls, and this one is a peach! The poster will grace an office, and those fond of nice things should send for one.

DEATH OF LOUIS C. GILLESPIE.

Louis C. Gillespie, president of Chas. H. Gillespie & Sons, varnish makers, Jersey City, N. J., died suddenly of apoplexy on May 17, while riding in his automobile at East Orange, N. J., where he resided.

SMOKER CONCERT.

The Automobile Club of America gave a delightful stag concert in its fine quarters, Fifty-fourth street, New York, May 3. The music was fine, the companionship jolly, the refreshments truly refreshed, and it was a glorious evening.

NEW COMBINE.

Regardless of their other effects, the suits for infringement of the Selden patent constituted by the Association of Licensed Automobile Manufacturers against nine Michigan manufacturers, served first to bring eight of them together and later to bring about the organization of another "independent" association, which has been talked of ever since the American Motor Car Manufacturers' Association, in February last, voted to "go out of business." The new organization was formed in Detroit, when the name Association of Motor Car Manufacturers was adopted.

AN EXCELLENT APPOINTMENT.

J. H. Wagenhorst has been appointed general manager of the United Rim Company, with headquarters at Akron, O. Mr. Wagenhorst is a hustler. He represented the Westinghouse Machine Co in the Cleveland district for a number of years and was considered one of their best representatives.

CHAS. N. DENNETT DEAD.

Charles N. Dennett, inventor of the jump seat, died at his home in Amesbury, Mass., May 22.

IMPLEMENT MEN DINE.

The Omaha Implement and Vehicle Club had a happy time at Happy Hollow on June 6, where a banquet was partaken of by members and guests. F. L. Haller was the toastmaster.

DEATH OF FRANK S. RIGGS.

Frank S. Riggs, treasurer of the King Fifth Wheel Co., Philadelphia, died recently, aged 61.

Wants

Help and situation wanted advertisements, one cent a word; all other advertisements in this department, 5 cents a word. Initials and figures count as words. Minimum price, 30 cents for each advertisement.

HELP WANTED.

Wanted—Live hustling foreman carriage and automobile painter in eastern city of 100,000. Address "Hustler," care of The Hub, 24 Murray St., New York.

Body Makers Wanted—Experienced on highest class limousine and touring bodies; steady work; good wages; pleasant location. Address C. R. K., care The Hub, 24 Murray St., New York.

HEAVY HARDWARE—WAGON WOOD STOCK.

Wanted—An experienced man in heavy hardware and wagon wood stock by an established heavy hardware house in the middle West, whose representative can be seen in New York during the next two weeks by appointment, by addressing D. P. O., Box 1146, New York City. All communications will be held strictly confidential.

INFORMATION WANTED.

Wanted—Any information as to the whereabouts of W. J. Lang, body-maker, will be thankfully received by his wife and family who have not seen or heard from him for over six years. Address Mrs. W. J. Lang, 5655 Garfield Avenue, St. Louis, Mo.

MISCELLANEOUS.

Shop Wanted—Carriage, wagon and automobile painter, first class letterer, striper and finisher, will rent or take good paint shop on percentage basis. Must be shop doing best and medium price work. References exchanged. Address L. W. 14, care The Hub, 24 Murray St., New York, N. Y.

PATENTS.

Patents—H. W. T. Jenner, patent attorney and mechanical expert, 608 F St., Washington, D. C. Established 1883. I make an investigation and report if a patent can be secured and the exact cost. Send for full information. Trade-marks registered.

Is Horseflesh Cheaper than Gasoline?

Motor vehicle manufacturers recognized early in the game that the greatest obstacle they had to overcome to make successful cars was friction.

They realized it was folly to have a high powered efficient engine developing power under the hood that would be used up overcoming friction in other parts of the machine, so they got busy in the right direction and replaced the old fashioned friction bearings wherever they could with

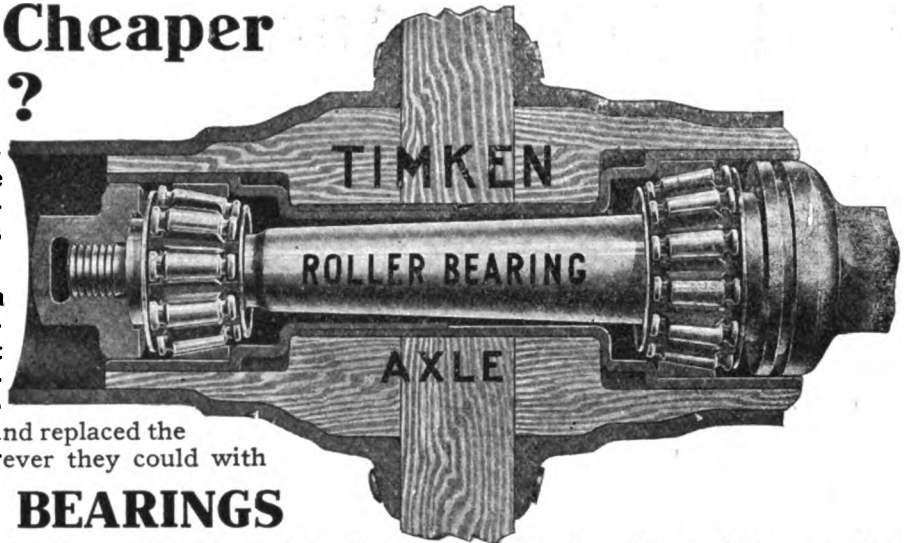

TIMKEN ROLLER BEARINGS

until to-day—say NINETY ODD (90) per cent of all the makers of high grade American Automobiles are using

TIMKEN ROLLER BEARINGS

in part or throughout in their cars—

And yet, strange to say, some vehicle manufacturers are still building and trying to sell vehicles that are not equipped with

TIMKEN ROLLER BEARINGS

Are you one of those that believes horseflesh is cheaper than gasoline?

IF YOU DO, WRITE US FOR "FACTS."

THE TIMKEN ROLLER BEARING CO. Canton, Ohio.

Branches
10 E. 31st Street, New York
429 Wabash Ave., Chicago, Ill.

Carriage Mechanics

Desiring to improve their present Condition should attend the

TECHNICAL SCHOOL

FOR

Carriage Draftsmen and Mechanics

SUPPORTED BY THE

Carriage Builders' National Ass'n.

The object of the School is to teach men to design vehicles and make working drawings, and to otherwise facilitate their work in the shop. Only those men employed in carriage or automobile building or their accessory trades are admitted to its privileges.

The classes are conducted in three divisions, viz.: Corresponding, Day, and Evening. The former is open during the entire year, while the day and evening classes are in session only from October 1st to April 1st.

The tuition is moderate.

For prospectus and full particulars, write to the instructor,

ANDREW F. JOHNSON,

18 West Forty-fourth St.,

NEW YORK CITY.

A \$100 Typewriter for 17 Cents a Day!

Please read the headline over again. Then its tremendous significance will dawn upon you.

An Oliver Typewriter—the standard visible writer—the \$100 machine—the most highly perfected typewriter on the market—yours for 17 cents a day.

The typewriter whose conquest of the commercial world is a matter of business history—yours for 17 cents a day.

The typewriter that is equipped with scores of such conveniences as "The Balance Shift"—"The Ruling Device"—"The Double Release"—"The Locomotive Base"—"The Automatic Spacer"—"The Automatic Tabulator"—"The Disappearing Indicator"—"The Adjustable Paper Fingers"—"The Scientific Condensed Keyboard"—all

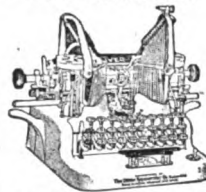

Yours for 17 Cents a Day!

We announced this new sales plan recently, just to feel the pulse of the people. Simply a small cash payment—then 17 cents a day. That is the plan in a nutshell.

The result has been such a deluge of applications for machines that we are simply astounded. Demands come from people of all classes, all ages, all occupations.

The majority of inquiries has come from people of known financial standing who were attracted by the novelty of the proposition. An impressive demonstration of the immense popularity of the Oliver Typewriter. A startling confirmation of our belief that the Era of Universal Typewriting is at hand.

The

OLIVER

Typewriter

A Quarter of a Million
People are Making
Money With

THE STANDARD VISIBLE TYPEWRITER

The Oliver Typewriter is a money-maker, right from the word "go." So easy to run that beginners soon get in the "expert" class. Earn as you learn. Let the machine pay the 17 cents a day—and all above that is yours.

Wherever you are, there's work to be done and money to be made by using the Oliver. The business world is calling for Oliver operators. There are not enough to supply the demand. Their salaries are considerably above those of many classes of workers.

Write for further details of our easy offer and a free copy of the new Oliver catalog. Address

The Oliver Typewriter Company

310 BROADWAY

NEW YORK CITY

Please mention "The Hub" when you write.

HOTEL CUMBERLAND

NEW YORK

Southwest Cor. Broadway at Fifty-fourth St.
Near 50th St. Subway Station, 53d St. Elevated and all Surface Lines.



Headquarters for Carriage and Automobile Trade

Ideal Location, Near Theatres,
Shops and Central Park.

**NEW AND FIREPROOF
STRICTLY FIRST-CLASS**

RATES REASONABLE
All Hardwood Floors and
Oriental Rugs.

Ten Minutes Walk to
Twenty Theatres.

Transient Rates, **\$2.50** with Bath, and up.
Excellent Restaurant. Prices Moderate.

SEND FOR BOOKLET.

HARRY P. STIMSON, **R. J. BINGHAM,**
Formerly with Hotel Imperial. *Formerly with Hotel Woodward.*



Richard Eccles Co., Auburn N. Y.

Manufacturers of

Forgings: Carriage, Wagon, Automobile, Special

Send for Catalogue.

TRUCK BUILDERS

If you only realized the inestimable value of roller bearing fifth wheels on trucks, vans, delivery wagons and all other medium and heavy vehicles, no job would leave your shop without

Roller Bearing Fifth Wheels

WHY? The adjustment is perfect. No oil or grease required. Almost indestructible. Will outwear any vehicle. Saves horseflesh and prolongs life of vehicle. Ask your jobber for the celebrated

—NIELSON OR KING—

Let us send you Catalogue and Price List.
American Roller Bearing Fifth Wheel Co.
745 THIRD AVE., BROOKLYN, N. Y.

INDEX TO ADVERTISEMENTS.

| | |
|------------------------------------------------|-----------|
| American Ball Bearing Co., The | 2nd Cover |
| American Roller Bearing Fifth Wheel Co. | 10 |
| Bradley & Son, C. C. | 4th cover |
| Cargill Company | 4 |
| Columbus Bolt Works | 4th cover |
| Consolidated Rubber Tire Co | 6 |
| Crane & MacMahon | 2d cover |
| Devoe, F. W., & Reynolds Co., C. T. | 3d cover |
| Eberly & Orris Mfg. Co. | 3d cover |
| Eccles Co., Richard | 10 |
| English & Mersick Co., The | 2 |
| Gifford & Son, John A. | 14 |
| Goodrich Co., B. F., The | 5 |
| Hoopes Bro. & Darlington, Inc. | 2d cover |
| Indianapolis Dash Co. | 14 |
| Jones & Co., Phineas | 11 |
| Keystone Forging Co. | 11 |
| LeCompte Mfg. Co. | 13 |
| Lounsbury & Sons, G. H. | 3d cover |
| Masury & Son, John W. | 2 |
| McKinnon Dash Co. | 4th cover |
| Moore & Co., Benjamin | 3 |
| Moller & Schuman Co. | 3 |
| Mott Wheel Works | 3rd cover |
| Murphy Varnish Co. | 1 |
| National Spring and Wire Co. | 11 |
| Porter, H. K. | 10 |
| Russell, Burdsall & Ward Bolt and Nut Co. | 3d cover |
| Schubert Bros. Gear Co. | 14 |
| Smith & Co., Edw. | 3 |
| Spring Perch Co. | 11 |
| Standard Oil Cloth Co. | 14 |
| Standard Wheel Co. | 1 |
| Timken Roller Bearing Co. | 9 |
| Uebelmesser Co., Charles R. | 12 |
| Valentine & Company | 3 |
| West Tire Setter Co. | 14 |
| Wilcox Mfg. Co., D. | 11 |
| Willey Co., C. A. | 2 |
| Woodman, Joel H. | 12 |

Please mention "The Hub" when you write.

FIFTH WHEELS—FORGINGS

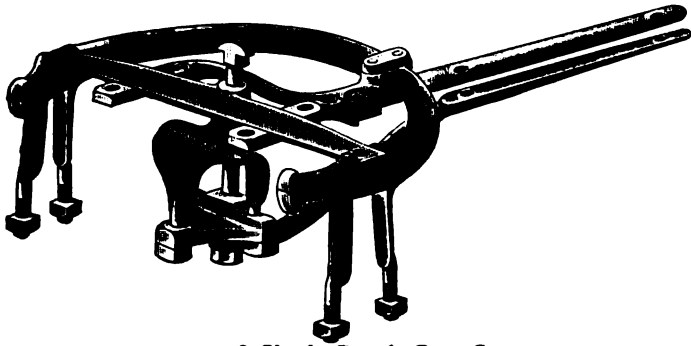

1908 Single-Reach Gear Set.

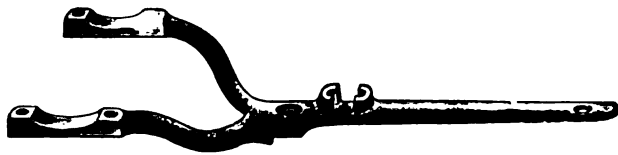

Detachable Fork Perch Connection Used in 1908 Gear Set.

Greatest Line on Earth

WHEN ORDERING GEAR SETS BE SURE TO GET THE GENUINE

Wilcox Rear King-Bolt Gear Sets

WRITE US FOR FULL PARTICULARS

THE D. WILCOX MANUFACTURING CO.

MECHANICSBURG, PENNSYLVANIA

Our Carriage or Spring Edge Cushion Frame



Is not an Experiment, but has been tried and stands the test.
We would like to quote you prices.
NATIONAL SPRING and WIRE CO.,
ALBION, MICH., and ST. CATHARINES, ONT., CAN.

Jones Wheels

BEST ON EARTH

KANTSAMORE

Phineas Jones & Co.

Newark, N. J.

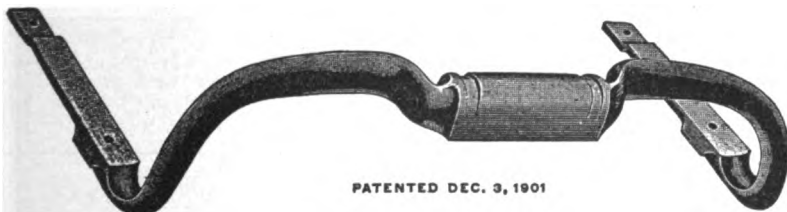

PATENTED DEC. 3, 1901

THE STANOARD BOOY LOOP

NONE LIKE IT NONE EQUAL TO IT
A popular body loop, unequaled by any on the market.
For further information, address

The KEYSTONE FORGING CO., Northumberland. Pa

CARRIAGE SPRINGS OF EVERY STYLE AND PAT- TERN TO ORDER

Also Curtain Rollers and Concealed Hinges
EXCLUSIVELY FIRST-CLASS WORK
THE BEST THAT CAN BE MADE

SPRING PERCH CO.

BRIDGEPORT, CONN.

Please mention "The Hub" when you write.

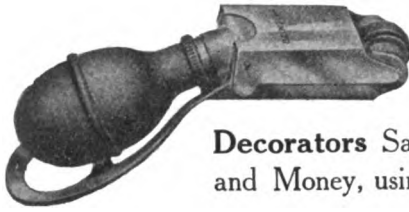

Painters and Decorators Save Time, Labor and Money, using the

Uebelmesser Striping and Stencil Wheel

With this simple, clean and rapid-action tool the most ordinary decorator can do the finest striping and stencil work and produce a bigger day's work with less labor than by the old fashioned method. Complete directions are furnished with each tool. They are as simple as the tool itself.

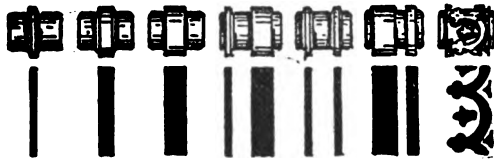

Just a few of the many designs that can be produced with the Uebelmesser Painters' and Decorators' Tool. (The designs shown above are reduced in size)

Complete Outfit consisting of Machine, 10 Plain and 10 Ornamental Wheels, only... **\$5.50**
LIBERAL DISCOUNT TO THE TRADE

Manufactured by
Charles R. Uebelmesser Company
Bayside, New York, N. Y.

Advertisements Classified

The following list includes advertisers in THE HUB. Each advertiser is entitled to name under one heading only. An extra charge for name under more than one heading.

Automobile Parts.

- LeCompte Mfg. Co., New York City.
- Axles, Etc.
- American Ball Bearing Co., Cleveland, Ohio.
- Timken Roller Bearing Co., Canton, Ohio.

Rubber Tires.

- Consolidated Rubber Tire Co., New York City.
- Goodrich Co., B. F., Akron, O.
- Goodyear Tire and Rubber Co., Akron, O.
- Swinehart Climber Tire & Rubber Co., Akron, O.

Bodies, Seats, Etc.

- Woodman, Joel H., Hoboken, New Jersey.

Shaft Couplings and Anti-Rattlers.

- Bradley & Son, C. C., Syracuse, N. Y.
- Eccles Co., Richard, Auburn, N. Y.
- Metal Stamping Co., New York City.

Bolts and Nuts.

- Columbus Bolt Works, Columbus, Ohio.
- Russell, Burdsall & Ward Bolt and Nut Co., Port Chester, N. Y.

Springs and Gears.

- Akron-Selle Gear Co., Akron, Ohio.
- National Spring and Wire Co., Albion, Mich.
- Spring Perch Co., Bridgeport, Conn.

Carriage Cloths.

- Wiese & Co., Wm., New York City.

Carriage Forgings.

- Eccles Co., Richard, Auburn, N. Y.
- Keystone Forging Co., Northumberland, Pa.

Trimming Materials.

- Stevens & Sackett Co., New Haven, Conn.

Carriage Hardware.

- Gifford & Son, John A., New York.

Carriage Goods.

- English & Mersick Co., New Haven, Conn.
- Gifford & Son, John A., New York.
- Herbrand Co., The, Fremont, O.

Varnishes, Paints and Japans.

- Devoe, F. W., and C. T. Reynolds Co., New York City.
- Harland & Son, Wm., London and New York.

Dashes, Fenders, Rails, Etc.

- McKinnon Dash Co., Buffalo, N. Y.

Masury & Son, John W., New York and Chicago.

- Moller & Schumann, Brooklyn, N. Y.

Fifth Wheels.

- American Roller Bearing Fifth Wheel Co., Brooklyn, N. Y.
- Wilcox Mfg. Co., D., Mechanicsburg, Pa.

Moore & Co., Benj., Cleveland, Ohio.

- Murphy Varnish Co., Newark N. J.

Jacks.

- Hankinson, J. V., Franklin, O.

Pierce Co., F. O., New York.

- Smith & Co., Edw., New York.
- Valentine & Co., New York, Chicago, Boston, Paris.

Lamps.

- Gifford & Son, John A., New York.
- Stevens & Sackett Co., New Haven, Conn.

Willey Co., C. A., Hunter's Point, New York City.

Wheels.

- Crane & MacMahon, New York.
- Gifford & Son, John A., New York.
- Hoopes Bro. & Darlington, West Chester, Pa.
- Jones & Co., Phineas, Newark, N. J.
- Standard Wheel Co., Terre Haute, Ind.

Machinery and Tools.

- Barnes Co., W. F. & John, Rockford, Ill.
- Porter, H. K., Everett, Mass.
- West Tire Setter Co., Rochester, N. Y.

Miscellaneous.

- Standard Oil Cloth Co., New York.
- Uebelmesser Co., Charles R. Payscale, New York, N. Y.

Wheel Stock, Bent Wood, Etc. Crane & MacMahon, New York.

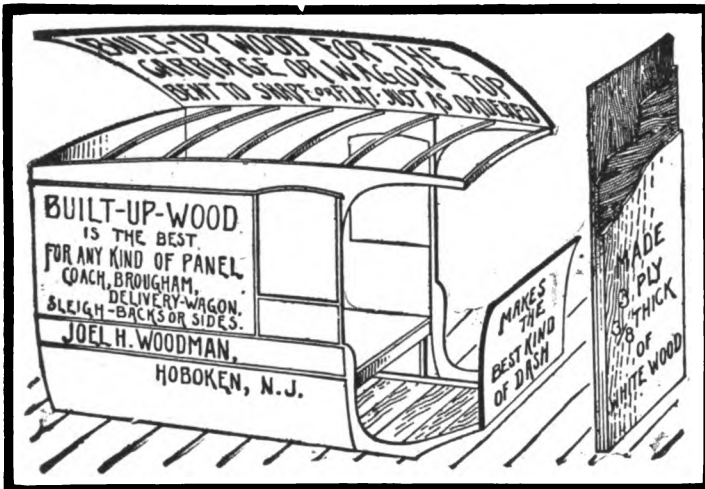

Journal for the Carriage and Automobile Trade

The Hub

Published Monthly at Two Dollars per Year

Contractors
Automobile Parts

**PLAIN
FINISHED
MACHINED**

CASTINGS

Write for a pair of our
Cast Metal Silver or Gold
Horse Bit Cuff Buttons FREE

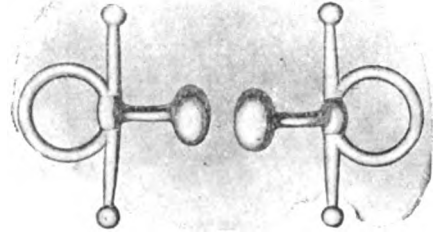

B^{Brass}_{ronze} A^{luminum}_{utomobile} BRONZE

MANGANESE BRONZE

POPE'S ISLAND

Non-corrosive Metal, Silver and Gold; Best known metal

HAND CLOSE PLATING

Seven Colors, guaranteed to last the life of car, carriage or harness.

ELECTRO PLATING

Black, White, Gold, Silver, Nickel, Brass or Gunmetal

Contracts made with car manufacturers

Horse Bits

"If it's a bit, we have it"

LeCompte Mfg. Co.

E. A. Whitehouse Mfg. Co.

} **Inc.**

OFFICE
110 Chambers St., New York

FACTORY AND FOUNDRY
44-50 Elm St., Newark, N. J.

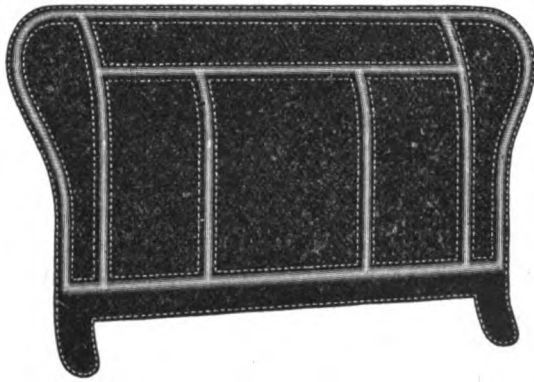

HIGH GRADE Dashes and Fenders

THE INDIANAPOLIS DASH CO.

INDIANAPOLIS

INDIANA

ESTABLISHED 1886.

Correspondence School of Carriage and Motor Carriage Drafting

A thorough, practical tuition is given through this correspondence school. The theory and practice of construction, bookkeeping, perspective. Many men now hold good positions through taking the courses of instruction.

Principal, THOS. MATTISON,
Hillside Avenue, Bitterne Park,
Southampton, England.

Author of "The Coach Body Makers' Guide," \$3.00; a practical treatise on "The Suspension of Carriages," "Bookkeeping," and other carriage building works.



COVER A carriage top with MERITAS enameled oil cloth—cover another with any other kind—follow them up and see how long the tops last.

MERITAS will be in good condition long after the other has been caked, cracked and weather-killed. Try it—then stick to the kind that lasts the longest.

Look on the back of the goods for our trademark.

See Your Jobber.

Standard Oil Cloth Co.
320 Broadway, New York

VEHICLES AND GEARS IN THE WHITE

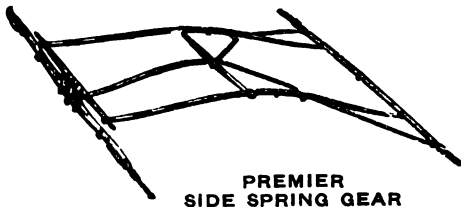

PREMIER
SIDE SPRING GEAR

We manufacture a full line of Carriage and Wagon bodies in the white; also Limousine, Taxicab, Touring Car and Roadster Bodies for automobiles in metal. Fifty styles of gears for Carriages and Wagons; also seats, trimmings and tops of all kinds.

Write to us for particulars.

Schubert Bros. Gear Company
ONEIDA, NEW YORK.

The WEST Hydraulic Tire Setter WILL CUT DOWN EXPENSE

Tires set cold in one minute. This machine saves time—does the work better and quicker, does away with burned streaks. Only necessary to measure one wheel in a lot. Does not char the rim and thus make the tire loosen prematurely. Saves re-sandpapering of wheels.

This machine is now increasing the profits of many manufacturers. Send for catalog and read about it.

WEST TIRE SETTER CO., ROCHESTER, NEW YORK

Please mention "The Hub" when you write.

F. W. DEVOE & C. T. RAYNOLDS CO.

101 and 103 FULTON STREET, NEW YORK

Manufacturers of

F. W. DEVOE & CO'S {
COACH COLORS
VARNISHES
BRUSHES
SPECIALTIES

C. T. RAYNOLDS & CO'S {
COACH COLORS
VARNISHES
BRUSHES
SPECIALTIES

FOR PAINTERS, ARTISTS AND DECORATORS

All the brands and specialties of F. W. Devoe & Co. and C. T. Raynolds & Co. will be maintained separately as heretofore.

WIRE WHEELS TO FIT EMPIRE BALL BEARING AXLES

Quality Unsurpassed

Write Today

The Mott Wheel Works
UTICA, N. Y.

Brazil Leather

FOR AUTO BUGGY TOPS

SEAT AND BACK SPRINGS,
COTTON, NAILS, WADDING,
MOSS, TACKS, WASHERS,
HAIR, BUTTONS, REEDS,
REED MOULDING,
CLINCH BUTTONS

G. H. Lounsbury & Sons
Cincinnati, Ohio

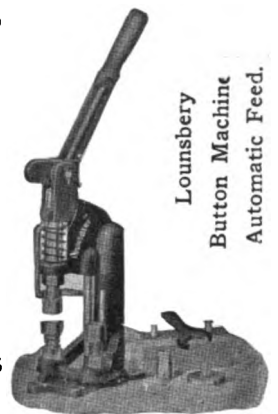

BOLTS Rivets, Carriage Makers' Washers
and Burrs for all kinds of Vehicles
Russell, Burdsall & Ward Bolt and Nut Co.
Main Works, PORT CHESTER, N. Y. Branch at Rock Falls, Ill.

Time Has Told the Story!

Service and satisfaction always follow our rolling stock

WHEELS

ALL KINDS—BEST QUALITY

Also RIMS and SPOKES

The Eberly & Orris Mfg. Co.
MECHANICSBURG, PA.

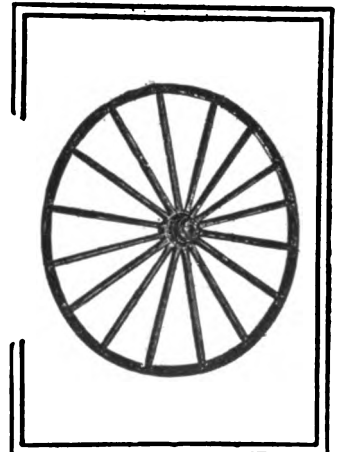

McKINNON DASH COMPANY.

TROY, OHIO.
CINCINNATI, OHIO.

NEW YORK, N. Y.

ST. CATHARINES,
ONTARIO.

ARE YOU

planning your 1911 Catalogue?
Consider the advantage of
showing wing dashes with line
rails, on all vehicle cuts. :: :: ::

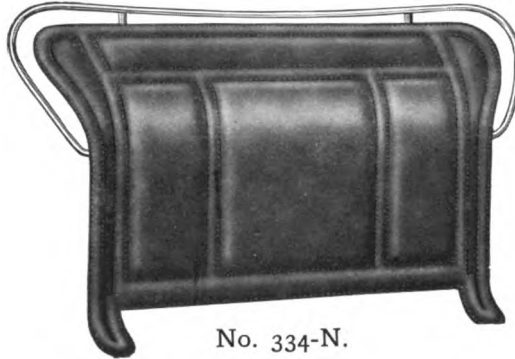

No. 334-N.

WHEN

describing quality of your work
in 1911 Catalogue the state-
ment "McKinnon Wing Dashes
Used" will tell the tale. :: :: ::

Skewed Shaft Couplings

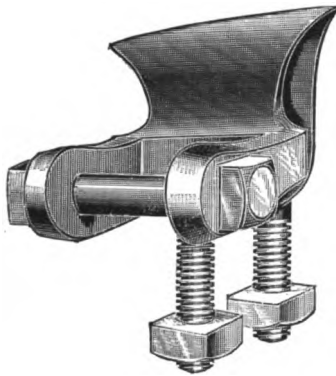

**Regular or Oval Patterns
For High Arched Axles**

Furnished in rights and lefts for any height of arch. Oval Axle
Clips $\frac{5}{8}$ or $\frac{3}{4}$ width to match Oval Couplings. Bolts, Clips,
Couplings, Carriage Hardware and Special Forgings

Catalogue "H" and Prices on Application.

COLUMBUS BOLT WORKS, Columbus, O.

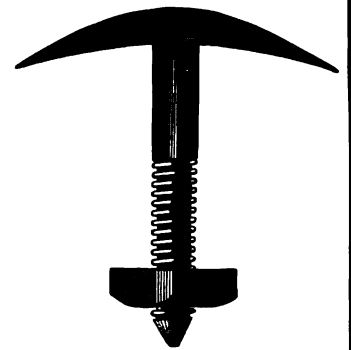

THE BRADLEY Carriage Coupler

**All steel, Noiseless, Quick Shifting,
Ball Bearing.**

The **ONLY** Carriage Shaft Coupler that is furnished with a
One-Piece Moulded Leather Packing

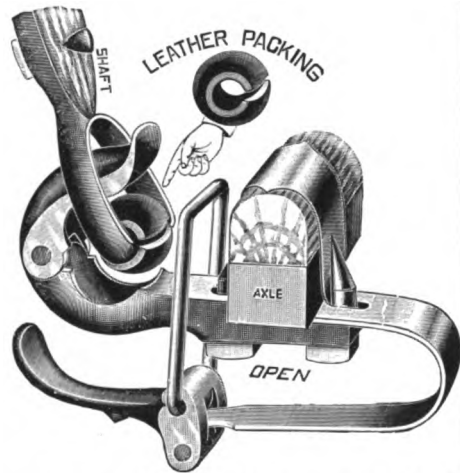

Placing the loop over the end of
the cap and drawing the thumb lever
back until it rests against the flat
spring closes the coupler, keeps it
closed, and takes up the wear of the
leather packing.



Unless a Car-
riage Coupler is
furnished with a
moulded leather
bushing and
steel spring
**JUST LIKE
THIS it is NOT
a BRADLEY.**

A packing that will outwear any other packing ever made. It fits the
ball and socket. It is held in place by a spring steel retaining ring. It
may be put on and taken off in a jiffy, and it stays where it is put.

C. C. BRADLEY & SON
SYRACUSE, NEW YORK.

The Hub

Vol. LII.

JULY, 1910.

No. 4.

AUTOMOBILES
CARRIAGES
MOTOR TRUCKS
WAGONS

TRADE NEWS PUBLISHING COMPANY
24-26 Murray St., New York, N. Y.

Hoopes Bro. & Darlington Inc.

West Chester, Penna., U. S. A.

SARVEN
STAR or KENNY
 Sweet Concealed Band
WOOD HUB
WARNER

WHEELS

HEAVY and LIGHT
 for
CARRIAGES
WAGONS and
TRUCKS

IF YOU WANT THE BEST TRY OURS

The Output of Complete FRONT AND REAR AUTOMOBILE AXLES of this Plant Exceeds the Capacity of All Competition Combined.

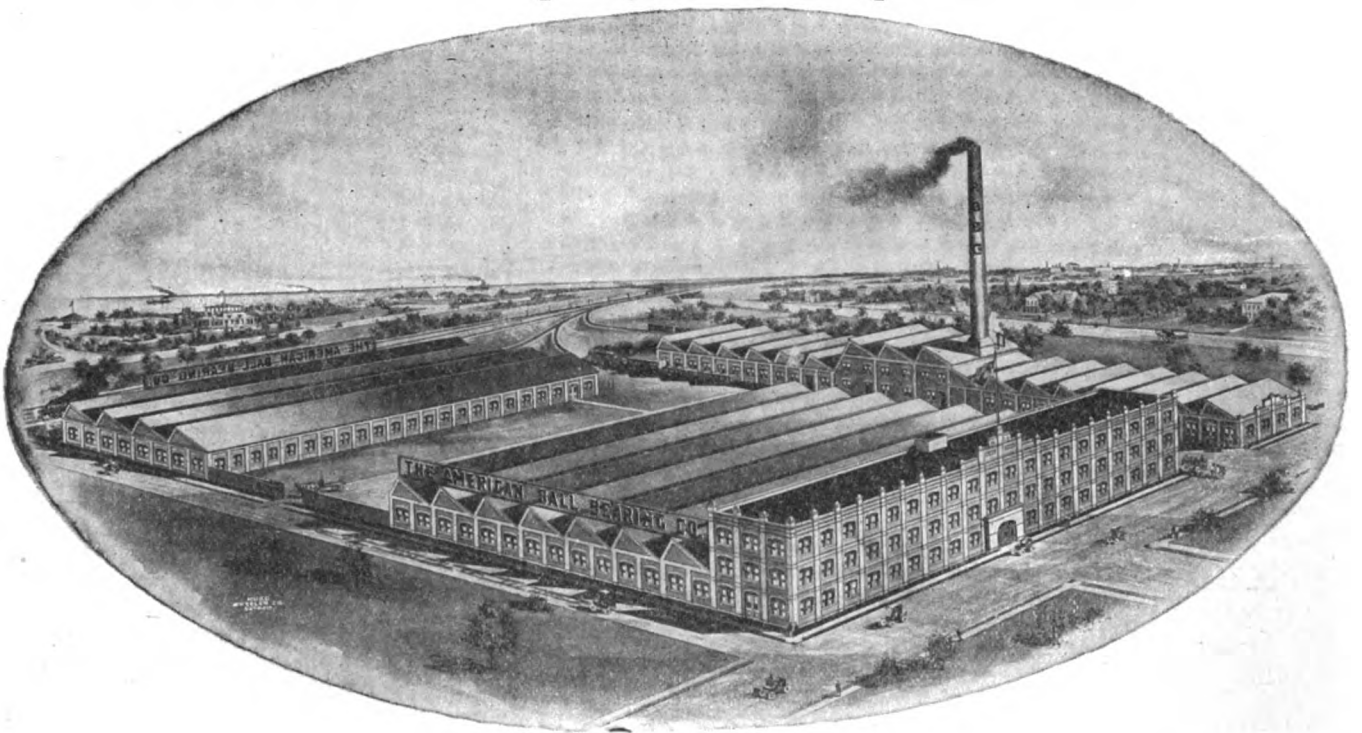

The American Ball-Bearing Co.,

L. S. & M. S. R'y and Edgewater Park.

CLEVELAND, OHIO, U. S. A.



CRANE & MACMAHON, (INCORPORATED)

8-10 Bridge St., NEW YORK CITY, U. S. A.

Sole Manufacturers and Exporters of the

HICKORY NUT,  ACORN,  and STAR  BRANDS OF

Carriage, Wagon and Automobile Wood Stock

FACTORIES:

ST. MARYS, OHIO. RICHMOND, VA.

For Export Prices apply to the New York office.

The Lake Superior Region is the Severest in the Country on Carriage and Motor Car Varnishes.

With drenching mists from the Lake; with hot, dry winds from the plains; with mud and dust that are full of granite grits—only the best possible Varnish endures.

The vast majority of the Carriage and Motor Car Owners in that wealthy region have learned to call for *Murphy Palest Durable Body* and *Murphy Palest Motor Car Body*. These are the Varnishes that stand the racket and stay new.

Let us send you our useful booklet, "Carriage and Motor Car Varnishes"
Address us carefully at 236 McWhorter St., Newark, N. J.

Murphy Varnish Company, FRANKLIN MURPHY
President.

THE VARNISH THAT LASTS LONGEST.

NEWARK BOSTON CLEVELAND ST. LOUIS CHICAGO

Associated with Dougall Varnish Company, Limited, Montreal, Canada.

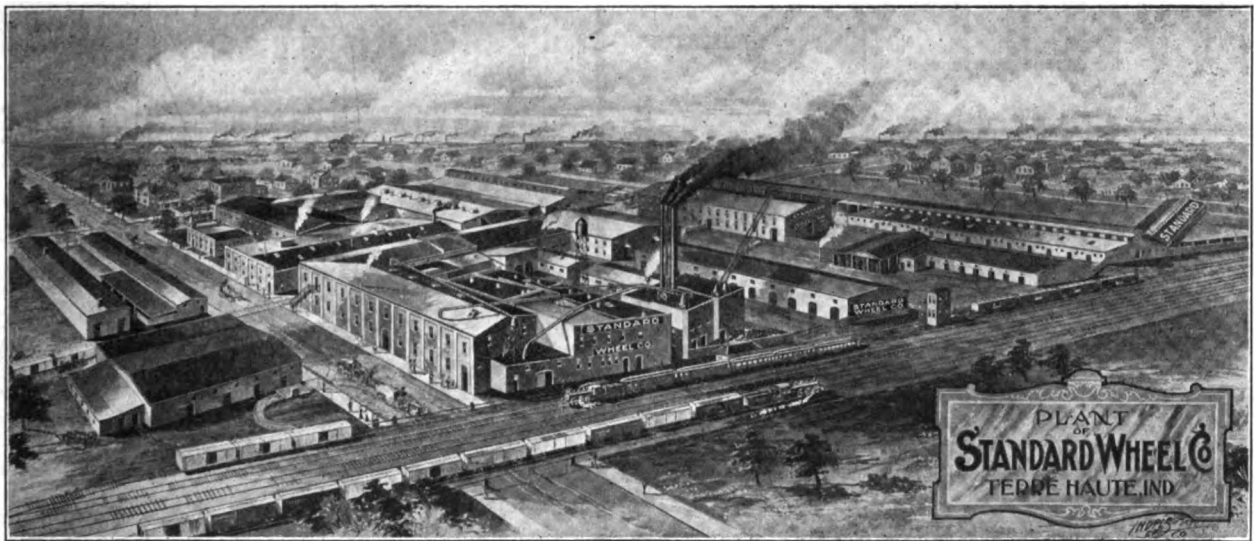

VEHICLE WHEELS AND WHEEL MATERIAL

Three Separate Departments [Light Carriage and Buggy Wheels
Heavy Express Wagon and Truck Wheels
Automobile Wheels

OUR GRADES ARE UNEXCELLED

WRITE FOR LIST.

Terre Haute, Ind. STANDARD WHEEL CO. Terre Haute, Ind.

JOHN W. MASURY & SON

Originators of

Superfine Coach and Automobile Colors

Acknowledged the Standard for Fifty Years

AND MANUFACTURERS OF

Fine Carriage and Automobile Varnishes

New York, Chicago, Minneapolis, Kansas City

WILLEY'S COLORS

The RECOGNIZED STANDARD



C. A. WILLEY CO.

COLORS GRINDERS

and Manufacturers of Specialties in

CARRIAGE, AUTOMOBILE AND CAR

PAINTS

COLORS, VARNISHES, ETC.

HUNTER'S POINT, NEW YORK CITY

THE STANDARD Auto Door Locks FOR NINETEEN TEN

No. 999 Security Hook Lock
for Touring Cars.

No. 25 Security Hook Lock with
complete lever control
for Touring Cars.

No. 39 Rotary Lever Lock for
Limousines and other
closed vehicles.

Test them out NOW for the
coming season. : : : :

English & Mersick Co.

New Haven, Conn.



**VANADIUM
VARNISHES**

The comet has faded away, but the brightness and durability of VANADIUM VARNISH is a permanent fact

Trade **VALENTINES** Mark

VALENTINE & COMPANY

New York Boston Chicago Toronto Paris Amsterdam

83 Years' Experience in Every Can



Edward Smith & Co.

CARRIAGE VARNISHES

Everything from the Bare Wood to the Finishing Coat.

CHICAGO

NEW YORK

**KIMBLE'S FAMOUS
GEAR WOODS**

still represent the highest standard of excellence and quality. True to our motto our line wins the approval of all vehicle builders.

WHAT CAN WE DO FOR YOU ?

**ANDREW KIMBLE
ZANESVILLE, O.**

RUB ————— RUB ————— RUB

THAT'S THE EXPERIENCE SOME PAINTERS HAVE WITH A POOR RUBBING VARNISH. THEY RUB TILL THEIR HEART ACHES ONLY TO HAVE THE VARNISH SWEAT, OR ROLL UP UNDER THE PAD

XX Diamond Rubbing and Hard and Quick Drying Rubbing "A"

DRY HARD TO RUB IN TWO DAYS, WITHOUT SWEATING, ARE TOUGH AND THE BEST FOUNDATION FOR FINISHING COATS.

MADE BY **MOLLER & SCHUMANN CO.**

MARCY AND FLUSHING AVES.,

BROOKLYN, N. Y.

Please mention "The Hub" when you write.

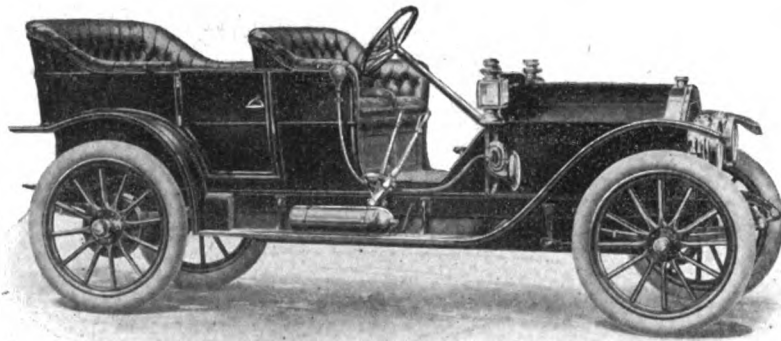

If you are to issue a catalog this Fall, why not get it from headquarters? The reputation of **The Cargill Company** for high class vehicle and auto work is unsurpassed by that of any other house in America. Write in your specifications and we will do the rest.

DESIGNING, ENGRAVING, PRINTING, BINDING UNDER ONE ROOF

The Cargill Company

Grand Rapids Engraving Company
Grand Rapids, Michigan

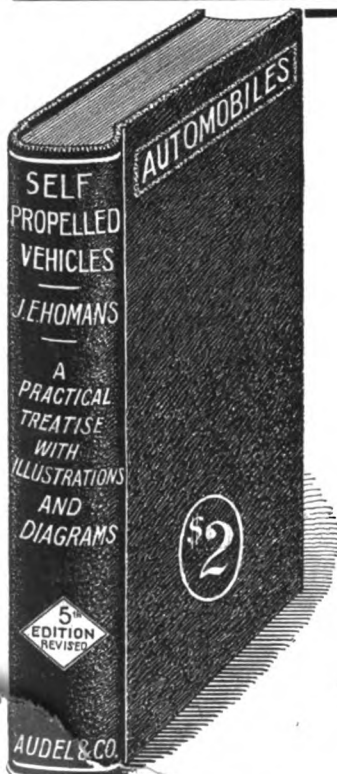

"Self-Propelled Vehicles"

Fifth Edition, Revised.

A practical treatise on the theory, construction, operation, care and management of all kinds of Automobiles.

By

JAMES E. HOMANS, A.M.

Contains 608 pages and upwards of 500 illustrations and diagrams, giving the essential details of construction and many important points on the successful operation of the various types of motor carriages driven by steam, gasoline and electricity.

This work is now the accepted standard, explaining the principles of construction and operation in a clear and helpful way. This book will be sent postpaid to any address in the United States, Mexico or Canada upon receipt of \$2.00.

Address

TRADE NEWS PUBLISHING COMPANY

24 Murray Street, New York

FOR SALE

MANUFACTURING PLANT

A complete and fully equipped plant for the manufacture of

Wheels, Spokes, Rims, Etc.

with a well established business and plenty of orders and material on hand to continue the business uninterrupted. Persons interested are requested to call or address

THE HUB,

24-26 Murray Street. New York City

Goodrich Solid Rubber Tires

Internal Wire Side-Wire Tires
Carriage Tires for Heavy Carriages

These products represent fifteen years of consistent development, and co-operation with customers. They have been distinguished always by the

Mark of Quality



Copies of the 1910 Catalogue will be gladly sent on request.

The B. F. Goodrich Company
Akron, Ohio

SOLVED!

Is the way the motor car experts express themselves on the subject of tires for commercial motor vehicles after seeing and using the

KELLY-SPRINGFIELD SECTIONAL TIRE

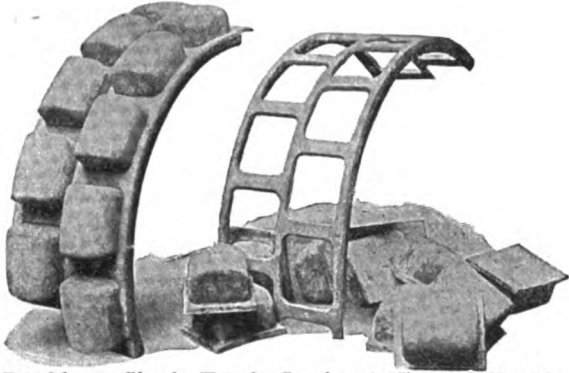

Double or Single Track. Sectional View of Double Track.

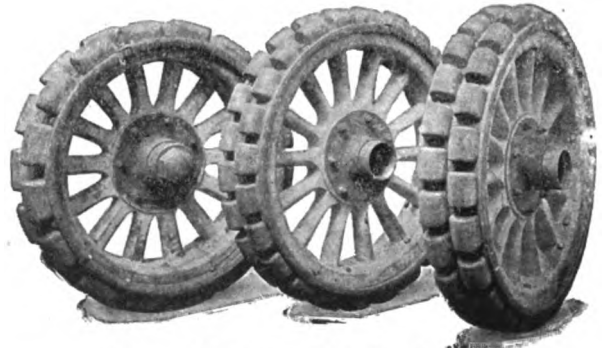

Patented May 17, 1898; April 9, 1901.

With a grip on the road that means progress and security from the fault of solid tires—that of crowding the rubber ahead under load, which means disintegration—the motor wagon and truck owner will find in the Kelly-Springfield Sectional Tires the best tire for all heavy cars. Each section is dependent upon itself. If interested, write :: :: ::

CONSOLIDATED RUBBER TIRE COMPANY
NEW YORK, N. Y.—and—AKRON, OHIO

Branches:

BOSTON CHICAGO PHILADELPHIA ST. LOUIS DETROIT CINCINNATI SAN FRANCISCO

American Harness and Saddlery Directory

FOR 1910 IS NOW
ON SALE

It is the most accurate
and complete edition
that has been published

Trade News
Publishing Company

24-26 Murray St., New York

THE list of the **WHOLESALE** and **JOBGING TRADE** is so arranged as to make it convenient to separate the association members from those not so recognized.

The **RETAIL HARNESS MAKERS** of the United States and Canada comprise the principal part of the Directory, arranged by State, Town and County, and in the large cities, the street and number is given. Those rating (approximately) over \$1,000 are marked.

A list of **HARNESS DEALERS** as distinguished from retail harness manufacturers, is also given. The value of this list to those who solicit the vehicle, implement, hardware and department stores will be readily appreciated.

THE BUYER'S GUIDE is a valuable as well as unique feature. It contains an alphabetical classification of all the many and various articles made to sell to the trade, and the names of those making the various articles.

A list is also published of Export Commission Merchants, giving the class of merchandise they handle.

THE PRICE OF THE DIRECTORY IS \$4.00, PAYABLE IN ADVANCE.

THE TRADE NEWS PUBLISHING CO. OF N. Y. Publishers of THE HUB

J. H. WRIGHT, *President.*

G. A. TANNER, *Secretary and Treasurer.*

24-26 MURRAY STREET, NEW YORK.

JACOB H. KLEIN, *Technical Editor.*

Other Publications of Trade News Publishing Co.:

HARNES (monthly)per year, \$1.00
AMERICAN HARNES AND SADDLERY
DIRECTORY (annual)per copy, \$4.00

THE HUB is published monthly in the interest of employers and workmen connected with the manufacture of Carriages, Wagons, Sleighs, Automobiles and the Accessory trades, and also in the interest of Dealers.

Subscription price for the United States, Mexico, Cuba, Porto Rico, Guam the Philippines, and the Hawaiian Islands, \$2.00, Canada, \$2.50, payable strictly in advance. Single copies, 25 cents. Remittances at risk of subscriber, unless by registered letter, or by draft, check, express or post-office order, payable to the order of TRADE NEWS PUBLISHING Co.

For advertising rates, apply to the Publishers. Advertisements must be acceptable in every respect. Copy for new advertisements must be received by the 25th of the preceding month, and requests to alter or discontinue advertisements must be received before the 12th day of the preceding month to insure attention in the following number. All communications must be accompanied by the full name and address of writer.

FOREIGN REPRESENTATIVES:

FRANCE.—L. Dupont, publisher of *Le Guide des Carrossiers*, 78 Rue Boissiere, Paris. Subscription price, 15 francs, postpaid.

GERMANY.—Gustave Miesen, Bohn & Rh. Subscription price, 12 marks, postpaid.

ENGLAND.—Thomas Mattison, "Floriana," Hillside Avenue, Bitterne Park, Southampton. Subscription price, 12 shillings, postpaid.

Extraordinary Expansion.

The striking feature of the news is the wonderful activity in the promotion and organization of new motor car companies.

We do not mean the organization of great plants involving large capital, but the small concerns springing up in all sections.

Of course, it is plain that these builders (?) are only assemblers, gathering the necessary parts from parts producers, putting them together and leaving the completed car a matter of body-building, trimming and painting.

Such cars, if well assembled, are very useful vehicles that can be sold at moderate prices profitably, at a price, indeed, more moderate than has yet been attempted. As the output grows the competition will become very severe, and the price equation will find its level.

The fact of greatest importance is the facility with which the vehicle builder may become an assembler of parts and a producer of completed cars.

The first result of this great production will most probably be overproduction, and any small general business set-back will bring about the revision of price that

will finally lead to the establishment of the new industry on a firm, steady, economical basis that will make for future stability and price in accord with real value.

Not very much attention has been given to the great strides in mechanical progress made by the organizations whose business consist in supplying parts. Very excellent engine and other essential portions of the power plant can now be purchased, so that the vehicle builder has only to exercise ordinary mechanical ingenuity to get that part of his work in trim. This is the only obstacle he has to overcome to make the remainder of the work a task with which he is entirely familiar and with which he is fully competent to deal.

Aid and Comfort of Technical School.

We notice news items to the effect that there is an unsatisfied demand for body draftsmen to work up new 1911 designs of automobile bodies.

Our technical school has lent a helping hand in this direction, and no doubt there will be yet greater drafts made upon its talent. Where else can the new material come from?

It is very generous of the legitimate carriage trade to support this school with its good dollars, so that the non-supporting motor car builders may be helped out as needed.

We believe that suggestions for contributions from the automobile folks always arrived, unfortunately, when the manager had gone to dinner, because there was never any substantial response.

If the school was a self-supporting institution there would be no occasion for comment, but as it stands, it would seem almost as if the sympathies of the motor car builder were somewhat contracted in the region of the pocket, and that he is perfectly willing to enjoy the product of the school without caring about its running expenses. It is not a very liberal position to take.

"1911" Styles.

Many of the important car builders are already, in June, announcing a preparedness to deliver 1911 models. This looks as if the business needed a trade hyperdermic that was being promptly administered.

A feature bulletined as "new" is the inclosing of the driver's seat with doors. There are some interesting modifications of this idea, some good, some freakish, but all selling and talking points of value, we suppose.

One of the leading concerns is putting much emphasis on its double door bodies as a matter of new design. The

newness is by way of France and is only two or more years old, but novel with us in that the introduction has been long delayed. We have not yet observed any original thought in design by the draftsmen in these shops, perhaps it is undesirable, perhaps it is easier to let the other fellow do the thinking, and enjoy the usufruct of his thought.

At any rate the styles for "1911" will be different, and some very pleasing.

What an Accountant Found Out.

A New York professional accountant has been investigating methods in large automobile plants and asserts that there is wastefulness and mismanagement in all manufacturing processes, and that few makers know the actual cost of production of the completed car or of its related detail parts.

He found men who knew nothing about a factory cost system, and those who were so instructed were so busy in getting out work that no account was taken of the economies of the business.

Some said they figured cost from invoices when material was bought, and guessed at when made in the factory, then the items as remembered were added together and multiplied by two, but to make assurance doubly sure the product was again multiplied by two!

Where the car was a completely assembled product more cost efficiency was found, which is easily understood.

Competition will be the school teacher that will change all this when the strain of disposing of product becomes severe, and the pennies must be accounted for or disaster result.

The present idea seems to be that it is really a waste of time to enter into hair-splitting details when demand is large and profits succulent.

The Law and the French Coachbuilder.

A new law has been made in France which "is applicable to all new designs, all new plastic forms, to all industrial objects that differentiate from its similitudes, either by a distinct configuration conferring a character of newness, or by several such effects," etc.

This has set the coachbuilder to thinking seriously. If this law is enforced no design can be improved upon by a second party, not even modified. It is unnecessary to amplify the idea as any vehicle builder can see the rocks leading to his undoing long before he is cast upon them. The Frenchman cuts the subject short by saying the law is impossible.

Important Expiration.

The death of the patent on the single tube tire (May 23, 1910) puts into the free-for-all class a product that was the subject of long-continued expensive litigation. It was a great money-maker in royalties. Curiously the patent was never protected in Great Britain. The inventor, a Mr. Tillinghast, is now dead.

The Rotary Engine.

The rotary engine has been the dream and despair of inventors. They have accomplished it several times experimentally, only to find it failed practically. It is the ideal engine for reasons that are obvious.

Recently in New York a banquet was tendered to a gentleman who claimed to have solved the problem. Very distinguished gentlemen from the point of view of money were the hosts, so it is fair to presume this time there will be something tangible in the rotary engine line.

Already we notice in the news of the day the formation of a company to make such engines.

Let us assume the difficulties are solved, and we are entering the practical stage. It will mark an era of importance with a direct bearing on the motor car, hence of particular interest to carriage men. Its application to the engine-propelled vehicle is likely to create decided modifications in construction, so its advent will be observed with feelings of the liveliest interest and curiosity.

Rubber and Speculation.

Much has been written about the vast proportions of the rubber speculation, the South Sea Bubble, etc., as it has been called, and the predictions of the effects of the coming "bust" are lurid and varied. It may all come true, probably will.

One consideration is of more ultimate value than all others. It is this: the speculation has been the only effective spur to make man get busy with plans for the production of enormously larger quantities of crude rubber, and the result will be plenty of rubber in a few years at very reasonable prices.

The speculation has been a splendid stimulant.

BLOCK TIRES NOT BLOCKED.

Block type or "sectional" tires, such as are extensively used on commercial vehicles, do not violate the New Jersey state law, after all, and may be used in that state without legal penalty, according to a decision by Judge Minturn, of the New Jersey Supreme Court, in setting aside the recent conviction of Paul J. Kubler, a driver who was fined \$25 and convicted by a Passaic police justice for driving a machine with block tire equipment. Kubler was prosecuted by Assemblyman Edward Thomas Moore, of Passaic, acting as a state inspector of motor vehicles, who alleged that Kubler's car, owned by the Hackett Motor Car Co., violated the state laws by reason of its having rubber blocks on the circumference of its wheels.

The decision is in the nature of a valuable victory for the Consolidated Rubber Tire Co., of New York City, which makes the tires in question, as arrests and fines have been imposed on drivers using these tires in a number of New Jersey cities and towns.

STUDEBAKER CLUB OUTING

A very enjoyable afternoon and evening was spent by the members of the Studebaker Club of the Studebaker Bros. Mfg. Co. at South Bend, Indiana, Saturday, June 25, when nearly one hundred members made an automobile trip from South Bend to Eagle Lake. The run was made in about forty minutes over rough, sandy roads. The afternoon was spent in fishing, baseball games, horseshoes, etc., after which an elegant fish supper was served, all members voting it the best ever and the event one long to be remembered.

Vehicle Fashions for July 1910

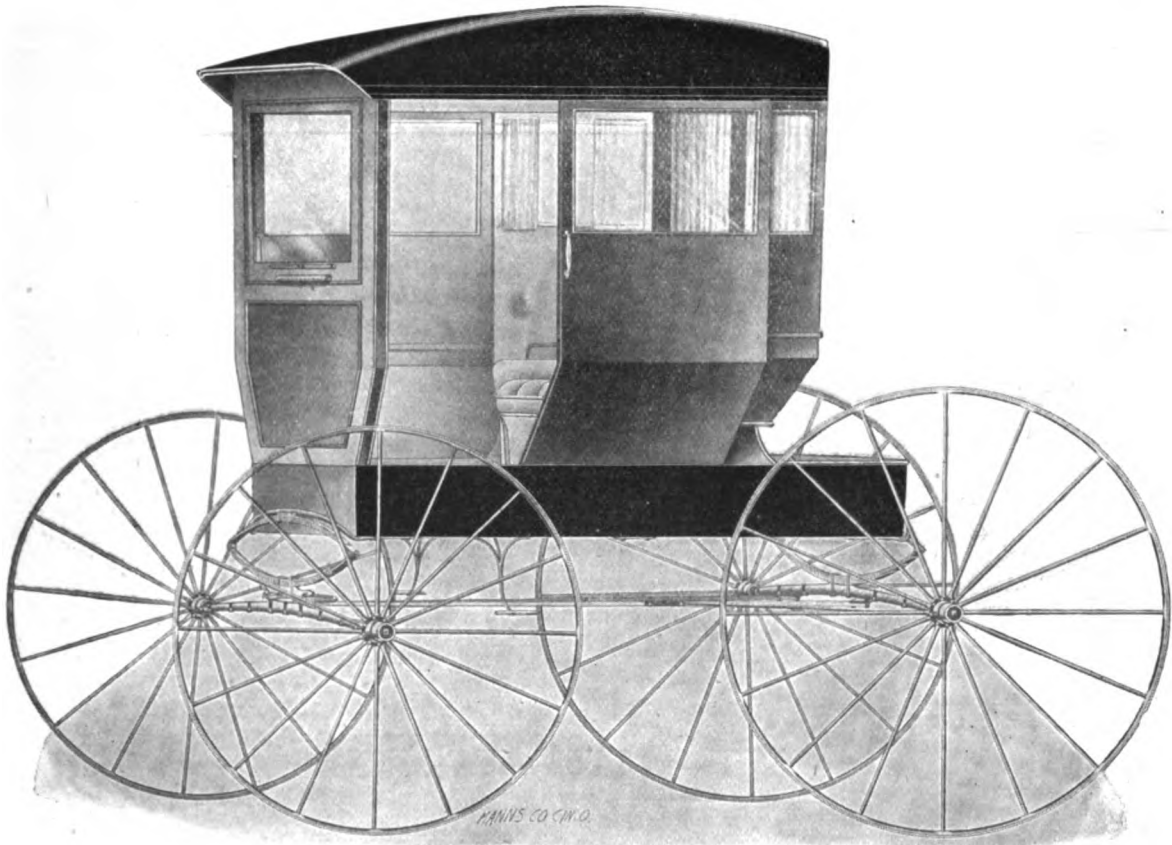

STORM TOP WITH SLIDING DOORS.
Built by The James & Meyer Buggy Co.



PIANO-BOX BUGGY WITH SUNK PANEL AUTO SEAT AND TOP.
Built by The James & Meyer Buggy Co.

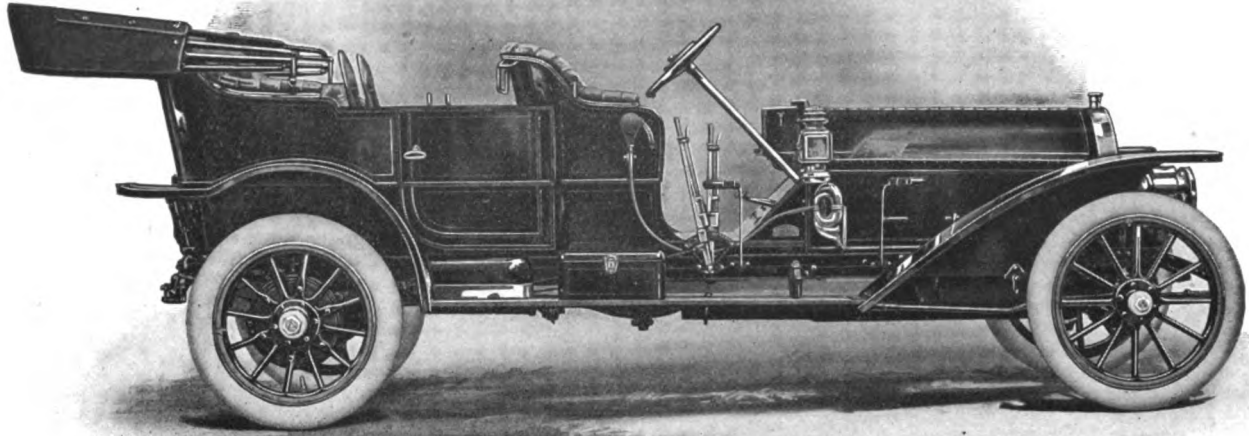

MODEL G—SIX-CYLINDER CAR.
Made by Stevens-Duryea Company.

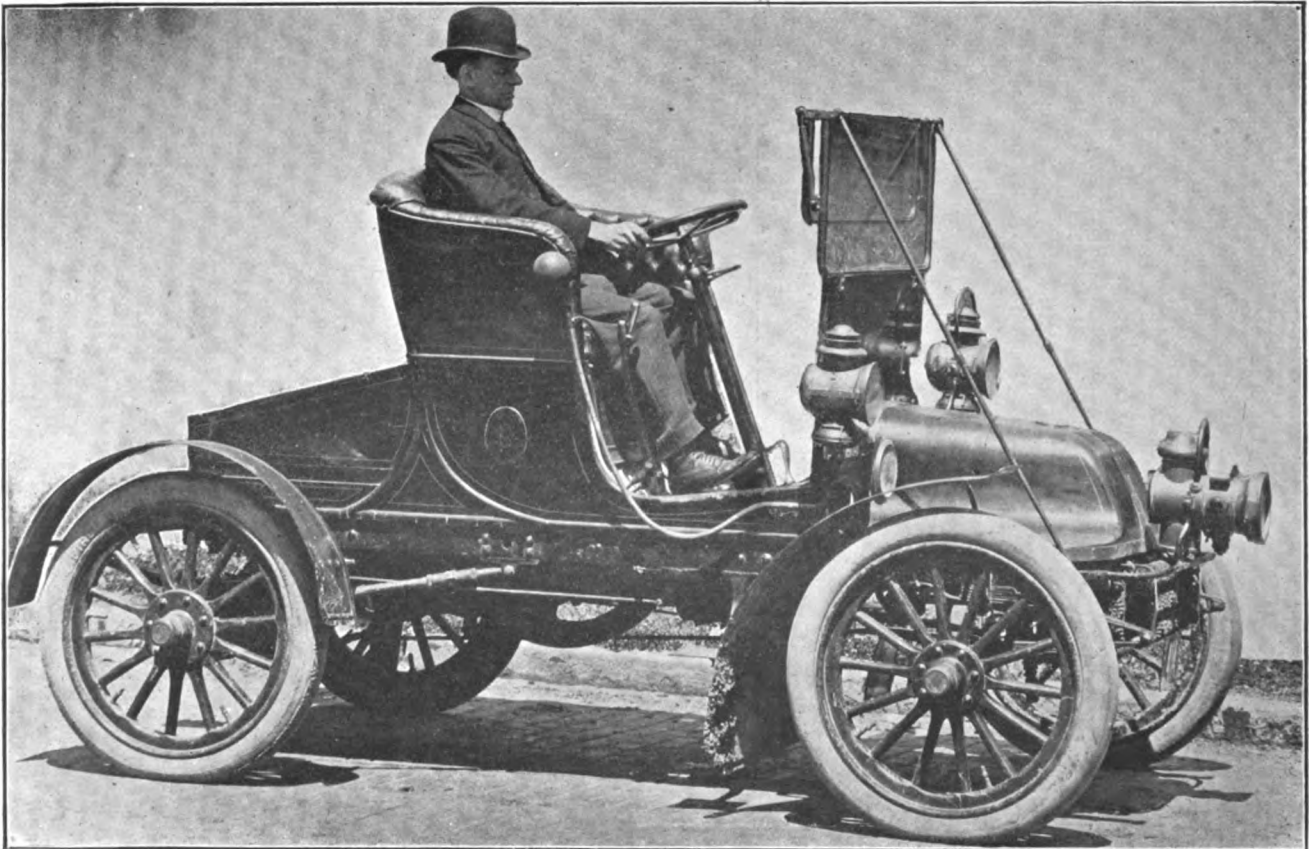

STEARNS VETERAN.
Made by F. B. Stearns Company.

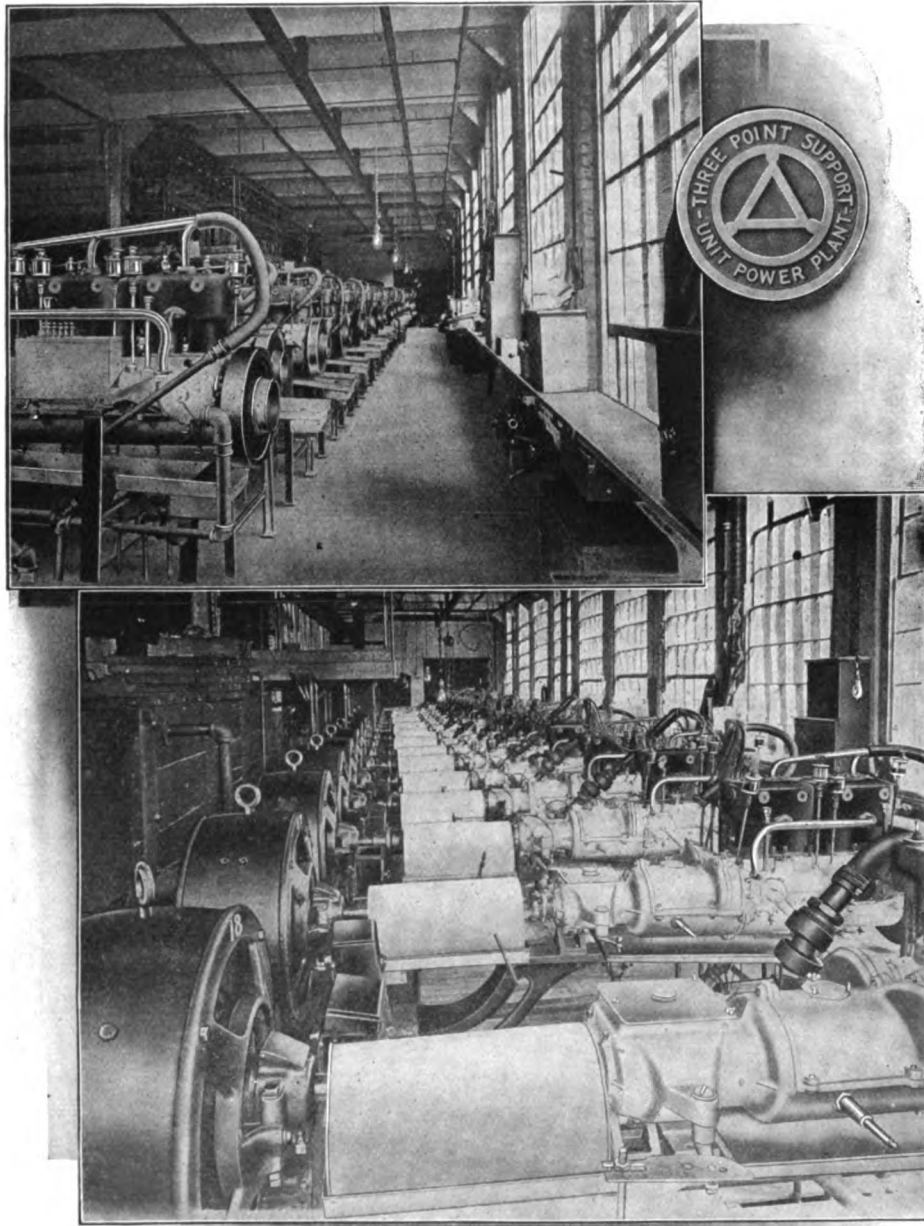

WHERE STEVENS-DURYEA POWER PLANTS ARE TESTED.

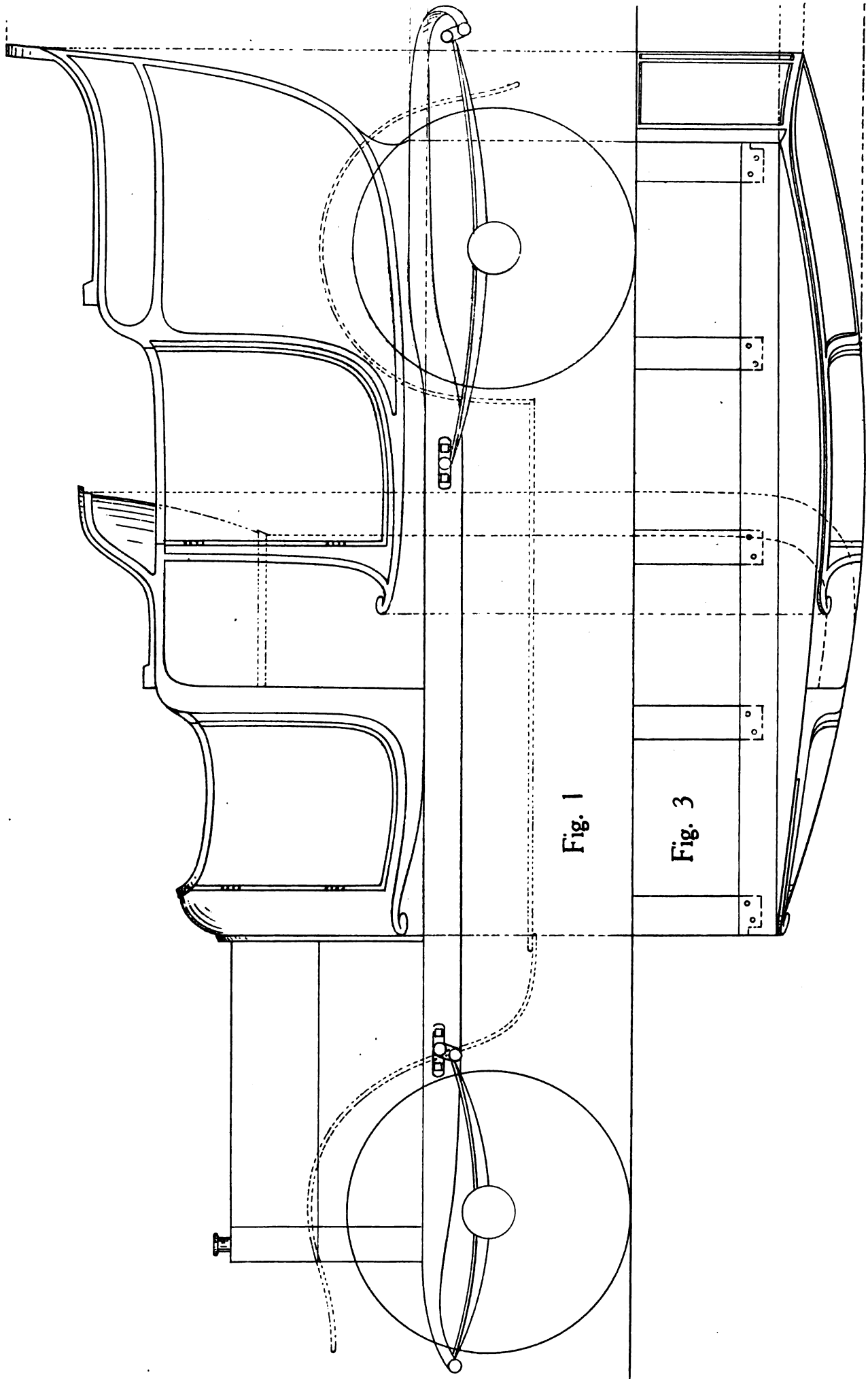

WORKING DRAFT OF FLUSH SIDED MOTOR BODY.
(Description on Opposite Page.)

Wood-working and Smithing

WORKING DRAFT OF FLUSH SIDED MOTOR BODY AND SUSPENSION.

(Drawing on Opposite Page.)

The lines of the motor body herewith given are full of boldness, delicacy and strength, while their combination lifts the vehicle to a plane of attractiveness which will court public favor.

The hind quarter is of massive depth, relieved with a waist belt panel, which is corner-curved to harmonize with the lines. The door is made to shut close up to the front pillar, a marginal panel moulding being boxed down to line with the door to take the lapping plate covering of the door's joint.

The controlling line of the quarter is a full, bold curve from

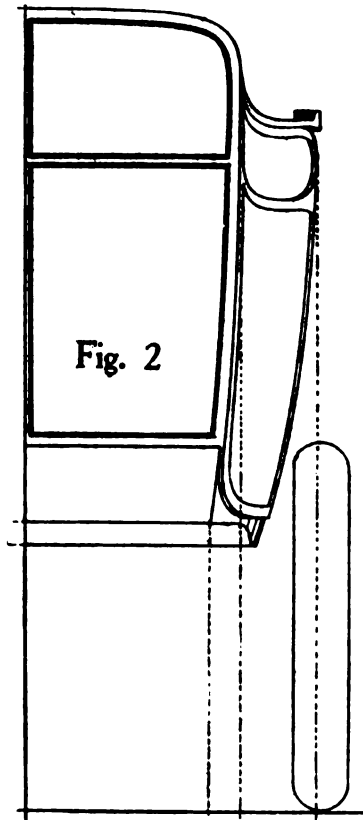

the elbow point, round to the eye of the chariot pillar, the faint lines of the corner pillar and bottomside blending nicely in to the quarters corner curve in the formation.

The front pillar is carried well on to the front quarter and finishing on the top of the elbow and door top line. The front quarter is plain, as is the front pillar, but boxed down for a panel moulding at the door shutting line to take the lapping plate bearing on the door joint.

The pillar is richly lined on its outer curve, and craned down the heel on the bottomside line on to the eye, the line and formation of the bottomside arm making a good finish. The standing pillar to which the front door is hinged, is got out the full width of the panel, and the curve covered on the top with metal or wood panelling. The latter is the best, and more closely associated with proper carriage body building.

The span of the wheels show a 9 ft. 3 in. base on the chassis, but there is no hard and fast line for this. A long span has long been shown to be the only safe base for motoring at a high speed. The chassis, it will be seen, are made to conform to the

design of the body behind, thus giving a better vantage to the hanging of the hind spring bearing as well as a more graceful depth to the scrolliron forged on the chassis end to take the spring. The lines of the wing and platform tread, with their points of fixing, are shown in dotted lines. The suspension is on grasshopper springs and scrolls. The springs should be balanced to keep a steady motion without lateral action, or as speed is set up a longitudinal rolling motion through too free an action.

In the suspension of a motor carriage, pneumatic tires are not everything. The proper motion and balancing of a spring to meet every condition of a car's work is quite as important, but it has not been given as much thought.

The designing of motor cars demand an exclusive vehicular building education, and in the near future, the motor car architect will be as much needed and specialized as the naval architect or the building architect is to-day, for he is badly needed now, and his presence and superintendence would make the manufacture run more smoothly and also more safely, but this matter has already been ably ventilated in The Hub.

Fig. 1 shows the elevation design and the suspension and shape of hind chassis.

Fig. 2 shows the half back view of body, and the half track of wheels on the road, the widths across back and the design as worked up in the panelling by the mouldings.

Fig. 3 shows the half plan or "Cant" of the body from which every point of the body can be accurately measured off, from the base line to the turnunder line, and the swell of the body in projection from the chassis frame. This is frequently more than ought to be if sound construction in the hanging is followed, because a wide projection does not give that stability of base for the body and chassis to work together, as when the bearing is more direct to the center of the bottomside.

A chassis ought to be designed in its width, to take the curve line of the body on its bottomside to the line of the turnunder curve. Then the full strength of the bottomside and chassis frame work in unison as to stability and strength. Some chassis are formed to meet this necessity, but the general run is on the lines of a parallel frame.

Of course, in a body of the design shown in the draft, a wide width of bottomside is necessary to get the swell on the bottomside at the center of the turnunder line, but to be a fully effective and protective help to the body, the chassis frame should be made to follow the conditional construction of the body.

The half plan shows the width of the bottomside on the chassis in a square on parallel line, and also the swell necessary to form up the turnunder side sweep. The proportionate curve framing lines of the front seat are also shown in dotted lines.

A flush sided design of body, admits of a fuller and cleaner job being made than where the side curvature is cut up with seat lengths of different widths and curves to the main side sweep. In this respect, the design of flush sided bodies, so popular now, is a great improvement upon those of sectional widths.

The sizes are: Length of body on chassis, 7 ft. 6 in.; full length of body from elbow point to front pillar at bonnet, 8 ft. 4½ in.; width of hind quarter on elbow line to door line, 2 ft. 9 in.; depth of quarter on pillar line at door, 2 ft. 3 in. to bottom of moulding; width of waist panel over moulding, 7½ in.

Width of door, 22½ in.; width of pillar over moulding at top, 2¼ in.; depth of door on hinge line, 26 in.; width of bottom of chariot pillar over eye from door line, 8 in.; width of front quarter from front of chariot pillar to front pillar on seat line, 17 in.; width of front body door on lapping plate line, 19½ in.; width of front hinge pillar at bonnet top, 5½ in.; depth of door on hinge line over mouldings, 22½ in.

Length of front bottomside from heel to eye of scroll, 2 ft. 4 in.; depth of front quarter on pillar line over all, 2 ft. 6 in.; width of front seat, 21 in.; depth of back seat over mouldings from top of seat line, 20 in.; depth of quarter from top of door line to top of moulding, 8 in.; width of panel on moulding line, 8 in.; width across body on elbow line, 38 in.; across front pillars, 53 in. (back quarter); width of body on chassis line, 33½ in.; turnunder on body, 4½ in.; swell on bottomside at centre, 4½ in.; width of ditto at centre, 9 in.; at each end, 4½ in.; centre of wheels in side span, 9 ft. 3 in.; width on track, 4 ft. 10 in.

NEW JAMES & MEYER STYLES.

(Illustrated on Page 95.)

The James & Meyer Buggy Company, of Lawrenceburg, Ind., furnish two recent styles. The influence of the automobile is shown in the piano-box buggy having the seat following lines familiar in automobiles, and the buggy top following somewhat similar lines.

The body is in three measurements ranging from 18 to 25x56 inches. The seat shows a sunk panel, auto pattern. The gear has a Collinge long-distance axle and French point elliptic springs. Top is three or four bow, skeleton, steel sockets, cloth quarters and hexagon curtain light. It is of the quick-shifting type. The painting is black for body, red for gear, or grain for a choice; seat panels like mahogany or rosewood to harmonize with gear.

The Storm King is a vehicle pretty nearly weather proof, and a most suitable style for one who must ride and drive no matter about the weather. The body is 28x56 inches, with inside bottom width of seat 30 inches, with four inches more across cushion. Collinge long-distance axles; steel body hangers. Frame made of selected yellow poplar covered with English long grain rubber drill; the inside is lined with green rubber drill and wool headlining; brass robe rail in front. Doors hung on double steel slides; impossible for them to bind in opening or closing; windows of double strength glass, front 18¾x32 inches, sides 13x17½ inches, doors 13x20 inches.

The painting gives the same choice of colors as mentioned in the piano-box buggy.

THE KIND OF RECORD THAT IMPRESSES.

(Illustrated on Page 96.)

Unlike some families, the F. B. Stearns Company is not ashamed of its beginnings. The illustration shown is of a car indicating so much longevity and vitality that it partakes something of the nature of "news" to allude to it. Its history is told in the quotation from the company annexed:

"The car shows Wm. Blackburn, purchasing agent of the F. B. Stearns Company, and illustrates better than words the longevity of Stearns cars.

"The machine is one of the single cylinder type, built by The F. B. Stearns Company about 1900. It was delivered to Mr. Blackburn over eight years ago, and has been in constant use ever since, averaging over 3,000 miles a season.

"Although its power plant consists of a single cylinder, it is powerful for its size, the cylinder being 6 inch bore and 6½ inch stroke. The transmission is of the planetary type, providing two speeds forward and reverse. A detachable tonneau, seating four persons is part of the equipment of the car."

STEVENS-DURYEA CARS.

(Illustrated on Page 96.)

A catalogue just issued by the Stevens-Duryea Company is so comprehensively interesting, and so clearly and well defines the methods of construction of the cars bearing the name, that aside from the elegance and perfection of the engraved illustrations, and the typographical excellence of the production, it

has a distinct educational value to anyone desiring real information.

In our illustration we picture the Model G six-cylinder car, as an example of good lines, and superior finish and well worked out details. We also show a picture where all Stevens-Duryea power plants are tested. The testing department is said to represent a heavy investment and is complete for the purpose. Instead of merely testing the motor alone, the unit power plant goes on the testing block. It is first "run in" for a period of several hours to insure smooth and harmonious working of all its parts. Then it drives the generator as a power unit for a long period under the closest approximation to service conditions that is possible off the chassis.

We also extract from the catalogue and here reprint a very interesting history of Stevens-Duryea motor car development new to many and forgotten by some: 1891, inception of the American automobile—the foundation of the Stevens-Duryea motor car; 1892, one-cylinder, friction transmission, chain drive—the prototype of a "horseless" era; 1894, two-cylinder, individual speed transmission, single-chain drive—progress in its first stages and a long step toward the realization of the perfect motor car of to-day; 1908, advent of the light weight car, adoption of three forward speeds; 1901, Stevens-Duryea, two-cylinder, single-chain drive cars, with three forward speeds, first placed on the market; 1904, four-cylinder shaft drive—adoption of "Unit-Power Plant" supported on "Three Points" and embodying the dry-plate clutch (multiple disc), marking advance of motor car construction—demonstration of Stevens-Duryea initiative and knowledge of correct mechanical principles; 1905, advent of the Stevens-Duryea six-cylinder car. The first to be marketed in this country; 1910, the "Unit Power-Plant" supported on three points—proven by their retention without change in six years manufacturing.

RETURN SHIPMENTS.

Defense of the practice of making reduced rates on returned shipments was made in Chicago by witnesses representing commercial interests who testified at the inquiry being made by the Interstate Commerce Commission. Representatives of Chicago wholesale concerns and traffic directors of implement companies were among the witnesses before Special Examiner Frank H. Lyon. W. J. Evans, secretary of the National Association of Agricultural Implement and Vehicle Manufacturers, testified regarding the effect of abolishing the privilege, all favoring keeping the low rate on return shipments.

Examiner Lyon ended the inquiry in Chicago. The commission is making a country-wide investigation into the practice of giving reduced rates on returned shipments. Many concerns, it is charged, have taken advantage of the privilege and have shipped goods at reduced rates, making false representations.

CARRIAGE MAN WON.

Albert Fisher, carriage builder, Detroit, Mich., won his case against the Fisher Body Co., getting a verdict for the full amount involved, \$15,688. The suit was the outcome of an agreement between the parties whereby Fisher was to supply 500 auto bodies to the body company, which later tried to repudiate the agreement.

BELT FRICTION.

If there is an atmospheric pressure of about 14 pounds to the square inch why will that same pressure not hold a belt to a pulley if it is simply laid on? What makes a belt pull at all? If a belt is slack under normal conditions, it will slip under a load. We cut a piece out of a belt to tension it. Then it pulls from tension. That tension is exerted on both sides of the belt, usually. It means more friction of the bearings, sometimes to the point of burning out boxes.

HANDY FOR WOOD AND PAINT SHOPS.

Mr. Mathers, an Australian builder, suggests some devices that he has found of service in his shop.

The first is a wheel stool for use when facing rims on a planer. The particular feature is the screw, which is solid and has a collar.

The lower half is a $1\frac{1}{4}$ in. screw, upper, plain $\frac{3}{4}$ in., round with square top to take a wrench. A piece of wood $12 \times 12 \times 1$ in. rests on collar and revolves with wheel. When facing, screw in

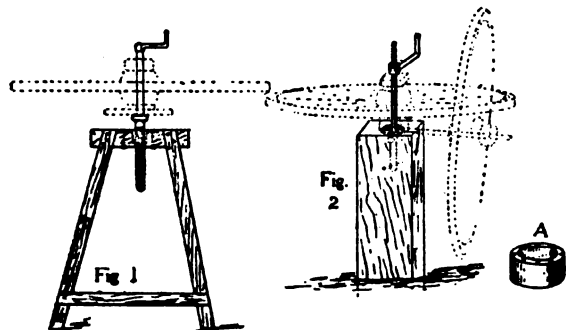

raised level with planer by turning handle. If a bevel is wanted raise the screw higher.

The second figure is a wheel stool to handle a newly-painted wheel without injury. Just put the wheel on spindle and pull it over. If it is needed to turn wheel place a wedge under spindle.

HIGH RECORD IMPORTS OF MANUFACTURERS' MATERIALS, 1910.

Importation of manufacturers' materials in the year which ends with June will exceed that of any preceding year in the history of our commerce. Figures of the Bureau of Statistics covering the ten months imports show in nearly every important article of manufacturers' use large increases in the quantities brought into the country. In hides and skins, in India rubber, etc., the quantity imported in the ten months of the current fiscal year for which figures are at hand is so far in excess of that for the corresponding months of earlier years that it is safe to assert that the quantity as well as the value of manufacturers' materials imported in the current fiscal year will exceed by far that of any earlier year. Comparing 1910 with 1907, the former "banner year," it is found that practically all of the important articles for use in manufacturing show larger quantities in the ten months of the current fiscal year for which figures are now available than in the corresponding months of the fiscal year 1907, which justifies the assertion that 1910 will become the "banner year" in the importation of manufacturers' materials, and presumably in the production of domestic manufactures.

Hides and skins imported in the ten months ending with April, 1910, show a total of 520 million pounds, against 297 in 1907, the former high record year in the importation of manufacturers' materials, and an aggregate value of $96\frac{1}{2}$ million dollars, against $66\frac{3}{4}$ millions in the corresponding months of 1907. India rubber imports for the ten months show a total of 90 million pounds, against 65 million pounds in the corresponding period of 1907.

The above statements relate to quantities, the purpose of discussing quantities only in this connection being to indicate more distinctly the actual gain in importation, since fluctuations in prices during the period under consideration would render the figures of values less instructive as to the actual gain of 1910 over 1907.

While estimates of the actual increase in the importation of the principal articles can be more accurately had by comparing quantities in 1910 with the quantities in 1907, the general estimate of increase in all imports can only be had by utilization of the figures relating to values, since the number of articles used

in manufacturing is so great that a comparison of the quantities one by one with those for earlier years is not practicable; and, if so made, would not supply the data for a measurement of the general increase in manufacturers' materials as a whole. Measuring the entire group "manufacturers' materials" in dollars, the Bureau of Statistics' figures show for the ten months ending with April, 1910, 728 million dollars' worth of manufacturers' materials imported, against 629 million dollars' worth imported in the corresponding months of 1907, the increase in 1910 over 1907 being thus about 16 per cent, and indicating that the manufacturers' materials imported in the fiscal year ending with June will exceed both in quantity and value those of any preceding year, and aggregate in value nearly 900 million dollars.

TIRE COMBINATION.

The Walpole (Mass.) Rubber Co. is a combination of the Valveless Inner Tube Co., Walpole Rubber Co. of Canada, Walpole Varnish Works and Massachusetts Chemical Co. The new combine will be directed by those at the head of the chemical company.

In addition to the factories at present in operation in Walpole, Boston and Granby, a new factory is being put up in Walpole, with a floor area of 100,000 square feet. This building is to be completed by August 1, and among other things will be used for automobile tire production. The company controls what is known as the Gleason fusible core process, which embodies the molding of the rubber over a core of metal having so low a melting point that, after vulcanizing the rubber, the metal may be melted and poured out through a small opening. The process gives a seamless result and is used in making tire tubes and horn bulbs.

WOOD RIMS.

Steam bent rims or felloes are sometimes giving the smith and wagon maker a good deal of trouble in putting them on over the spokes, especially if the wheel is low and the rims short and heavy as in truck wheels.

When the spokes have been prepared and the holes in the rims bored, begin with one end, and hammer that end on as far as it will go and not break the tenons; then have a hook to draw the spokes together, and if need be straighten the felloe out. This can be done with a screw buckle or wedging it apart; if this is done, there is not much danger of breaking the tenons of the spokes. Cut the tenons of the spokes off even with the rim to enable them to help hold up the burden.

Some carriage makers cut the tenon off lower than the rim leaving the bearing all on the narrow shoulder. This causes the shoulder to sink into the felloe and you have a loose tire or a felloe-bound wheel, probably both.

TRANSFER INTEREST.

In an instrument filed at the register of deed's office in Janesville, Wis., Mrs. Dorathea Buchholtz, widow of the late F. H. Buchholz, of Janesville, the Misses Eda F. and Gertrude L. Buchholz, and C. W. Buchholz and wife of Salt Lake City, Utah, deed to George O. and Carl A. Buchholz of that city, as trustees, seventy-five shares of the Janesville Carriage Co. stock, which represents their combined interest in the concern.

AIR-CLEANED PAINT.

A novel use for pneumatic machinery is in cleaning of old iron and getting the old paint off. A sand blast is turned on the paint and run by compressed air the old paint melts off like snow before a June sun. Following the sand, the air is used to clean off the dust and the iron is very quickly put in condition for the machinist.

THE FARM WAGON TRADE.

(Contributed by E. W. McCullough, Sec. National Wagon Manufacturers' Association.)

Most forehanded dealers who have been on earth long enough and through panics and temporary setbacks sufficient to realize that there is certain equipment which is absolutely necessary to the operation of every farm, have already placed their orders for their Fall requirements and will stand the best show of getting them when wanted.

It is also true that there are some naturally cautious who wait until the advancement of the crop is satisfactory to them before ordering, and also some whose wagon trade has been light for a year or two past who are still deferring action and to them perhaps a word of caution may be well received as it is well meant.

Little good can come from holding post-mortems on what is past for it matters little now whether the manufacturers made too many wagons and too good, or whether the farmer and consumers took better care of them and made them last longer than anticipated, we know that for nearly three years the country generally has not taken its normal requirements of farm wagons, yet those in use have been wearing out at the usual rate in hauling the great crops of this country.

For a time our desire for luxuries enforce upon us an economy in the purchases of necessaries but this is only temporary and the reaction always returns the demand for staples. Such a reaction is now due in farm wagons for with the largest acreage of crop ever sown in this country now maturing nothing short of absolute crop failure can prevent good demand for wagons, remembering that there is no substitute for them as a crop transportation vehicle.

Again the handling of staples and of getting a satisfactory profit on them is purely a matter of salesmanship and there is neither necessity nor sense in handling any line of goods as an accommodation or drawing card. Many a manufacturer, jobber or dealer has learned by bitter experience that in such heavy lines as implements and vehicles very few attempts at "baiting" the trade by making a low price on staples ever succeed—the game is so transparent that the "baits" are taken and the competition on other lines continues the same.

Farm wagons should not be handled either as an accommodation or a necessity, for no dealer can afford to do this because of the investment it requires, and secondly because it will cause his competitor to retaliate by cutting price on some other line.

There are few lines handled by the implement dealer which are more clean and satisfactory when conditions are normal than the farm wagon—it requires no experts to set it up and when sent on its way requires no "doctors" afterwards—twenty or more wagons sent out new each season bearing the dealer's name and address pay a continuous advertising profit worth considering—there is no chattel on which the dealer takes security which deteriorates so little and is so readily saleable as the farm wagon. It is one of the most profitable lines the dealer handles if he is a salesman and treats it fairly, and I challenge any merchant to name any other line of implements or vehicles which have proven more satisfactory or profitable than farm wagons for a continuous period of ten years; providing he has not during that time sold his wagons at less than a net profit of five per cent over and above the cost price plus the cost of doing business, and considering the volume of business done in each line; in other words, I mean to state without fear of contradiction that the farm wagons handled by any dealer who has treated them from a cost and expense and salesmanship standpoint on an equality with his other lines will find they have been handled with less trouble and expense and have paid in net profits equal to any line of goods handled in like quantity for the same length of time. Some lines not strongly competitive for which there is a limited or spasmodic demand may show larger profit per sale but it is the article that can be sold any time of the year, which requires no expense of looking after and

for which there will always be a demand that overtakes and outruns specialties that are only in temporary demand and require much expense and effort to get started and keep in order.

No merchant is taking any risk in providing for his supply of wagons at this time, for wagons will never again be manufactured and sold in their present form at less price; secondly, the panic of 1907 has not been without its lessons and there is little danger of the error of overproduction being repeated—in fact, the output of wagons has been so measured by the demand during the past two years that to-day stocks everywhere are low and there is a real danger that a large demand could not be satisfied. We advise no dealer to buy beyond his reasonable needs for while additional profit may occasionally be made by anticipating a shortage more often it is lost by overloading.

That there will be advances in the cost and selling prices of staple lines is inevitable for we are on a higher and more expensive plane of living than ever before and from the present outlook are likely to remain here, but the wise business man will adjust himself to these conditions on the basis of what it costs to do business. He will continue to handle wagons and everything else that properly belongs to his line and make money on them.

THE WOOD PLANT AT KINGSTON.

W. A. Wood Automobile Manufacturing Co. is about to enter the automobile field. They have purchased the Packham Car & Truck Company's plant at Kingston, N. Y., comprising seven acres of ground, with five buildings fully equipped with machinery and power plant, the main building being 325x75. The production will be high-grade pleasure cars, 30 to 60 horsepower, with chain or shaft drive, and a 30 horsepower chassis for run-about or touring car or town car service. An important part of the production of the new plant will be the manufacture of commercial trucks, and for this purpose an arrangement has been made with the Commercial Cars, Limited, of England, manufacturers of the Commer truck, for the reproduction of this truck under the existing designs, with slight modifications, adapting it to American use.

REVIEWING TIMKEN BEARING PROGRESS.

As a mark of confidence in roller bearing theory, as translated in the product of the Timken Roller Bearing Company, Canton, O., nearly a hundred motor car manufacturers in this country are now using Timken shaft mountings. Of this market, which naturally represents a huge outlay of manufactured material, 67 customers are builders of gasoline pleasure cars, 30, or thereabouts, of commercial vehicles; and a half dozen are makers of electrics. The complete list is published as an appendix to a new brochure, which the Timken bearing company just has issued, and which deals with the growth, refinement and scope of this business—three impressive factors. The booklet is profusely illustrated with pictures which show Timken bearings in the making, and in themselves tell a graphic story of clean and exact workmanship.

TWICE-TOLD WISDOM.

In hardening springs the heat must be a low red, as seen in the dark. So use spring into a tub of lukewarm water, or bury in cold sand or cool in oil. Either way will answer requirements.

To drill chilled iron prepare a drill thicker than usual at the point, oval in form, and then harden by heating to cherry-red and cool in a compound made of two quarts of soft water, half ounce sal ammoniac, three ounces salt. When drilling use water in place of oil. Feed with care, but keep drill up to its work. If the iron should prove too hard, heat to a low red and put brimstone just where you want the hole. It will drill easily.

Carriage and Automobile Painting

REWARMED VARNISH HINTS.

There is no subject so well thrashed out as varnish and varnishing. The Hub in its long career must have printed miles of such copy, yet to-day the subject is the same, and the difficulties of it have not changed.

As a relief from the carriage varnisher's point of view, let us see how the furniture finisher views it. It sounds very familiar, and here and there is a suggestion. The old, familiar desiderables—a perfectly dustless room and article, and a temperature of from 60 to 70 degrees, this temperature to be even. Then there must be ventilation without draft, a good light—plenty of it, well matured varnish and a good brush. A good deal of ill-success comes from the want of the conditions here enumerated. It is a very poor policy to have a poorly lighted and poorly ventilated room in which to do the varnishing.

It is economy to use the best grade of varnish that the job will admit of, rather than skimping on quality in order to save a few pennies a gallon on the varnish. A low grade varnish will not go as far as a better grade and hence may be dearer than the higher priced article. Often the buyer is not a practical varnish man and he buys according to the list of prices.

A first class hand at rubbing is an important factor in the finishing room, though a boy is sometimes put at the work. The good rubber is one having knowledge of varnish conditions, knowing when a surface is ready to rub. For large plain surfaces he uses a thick perforated felt pad. Taking a piece of Spanish felt, which may be as much as two inches thick, he will split this into thicknesses suitable to the different kinds of rubbing he is to do. Some prefer heavy woolen cloths rolled up to form a pad as it is largely a matter of individual preference and good results can be had either way. It is in the man more than the pad.

VARNISH TROUBLES.

Here is an account of old friends, as described by a writer in Wood Craft:

You have noticed the sunken in appearance of varnished work at times, and wondered at the cause. Too much oil in an under coat of varnish may cause the trouble. If the work shows less gloss than you anticipated then ascertain whether your brush had been washed out in turpentine or not; sometimes the trouble comes from this source. The same is true when the brush has been standing in oil. If the finish shows seediness or grit, probably you thinned up the varnish with turpentine while cold. If the work cracks then the varnish was poor, not sufficiently elastic. Adding turpentine to a good varnish will also cause this trouble; or, if the under coat is a slower varnish than the finish. Oil or moisture will cause blistering. Blooming is caused by new varnish, driers, adulterated oil in the under-coat, making it tacky, or where just paint is under, or when dampness hits the undry varnish, as also chemical fumes, grease fumes, or frost. If the job dries tacky when you have used good varnish, look for grease on the under surface or dampness. If the dry surface easily mars or scratches white it is a sign of rosin varnish. Also, if a drop of water causes the spot where it lies to turn white it is an indication of rosin.

The man who knows his varnish and has shop conditions right will know when the surface is fit to rub. He never would attempt to rub when the surface was not hard dry. It would roll or soften up under brush. The directions on the can may say it is fit to rub in twenty-four hours, say, but that will depend. If all conditions are right then the instructions may be followed;

otherwise the workman will be guided by other directions, such as condition of weather, shop temperature, etc. After the rubbing is done and a coat of varnish is to follow, the job should be allowed at least twelve hours in which to harden. Then a light rubbing with rottenstone powder will give a satin surface, for a finish or more varnish.

When varnish first comes to hand do not shake the can up but handle carefully and set away in a dry and warm place until wanted for use. It is not generally known that this shaking up of varnish will cause some trouble from pitting due to the air being shaken and taken up by the varnish. The remedy in such a case is to take the stopper out and let the can stand in a clean, dust-free place until the air and gas escapes and the varnish settles to normal condition.

Creeping is caused by several things, but one cause is generally overlooked or not thought of at all, namely, that when a job is done and allowed to dry over night, the shop may become much cooler in the meantime, and so cause the creeping from chilling.

Silkiness I have not yet alluded to. It may be caused by the shrinking of the wood. Adding thinners to varnish will cause it. This is particularly the case when the work is subjected to a strong sunlight. The silky appearance is due to a vast number of fine lines lying very close together, and which may become larger and wider later on. These cracks you will find are sharp and clear-cut, crossing the work in all directions. Cracking itself is often caused by applying a quick drying varnish over a slower one, or vice-versa.

HERALDRY FOR PAINTERS.

Sometimes the painter has to paint a piece of heraldic work from an engraved black design. In such case if the shields are correctly engraved the placing of the cross lines and horizontal lines will interpret the colors to be used. In the accompanying illustrations various shaped shields are shown divided into established heraldic proportions by simple straight lines.

Dealing first with the shape of the shield: One of the earliest examples is shown in Fig. 1. The shield is divided by lines ((in

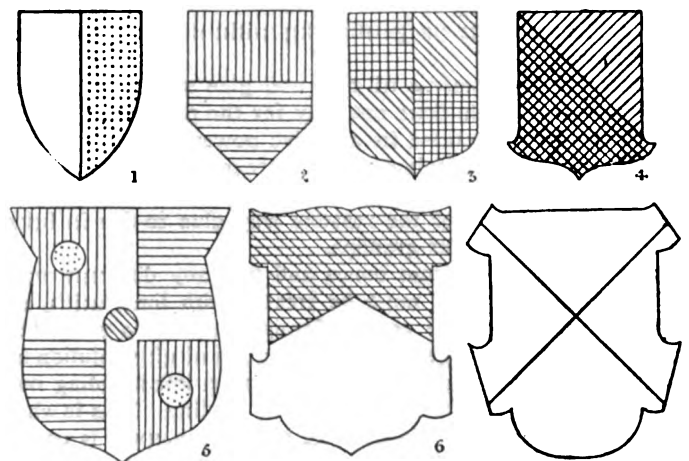

the present case only straight lines are used) into different parts, as per pale (vertically Fig. 1), per fesse (horizontally Fig. 2), per cross or quarterly (Fig. 3), per bend (Fig. 4), per chevron (Fig. 6), and per saltire (Fig. 7). These are the common divisions, others occur, but only a thorough study of the subject can cover all the ground.

The metals and colors are represented by dots and lines. Thus

in Fig. 1 the plain surface on left hand indicates silver, the dotted portion, right half, gold. Vertical lines, as in Fig. 2, represent red; horizontal lines, blue. Lines inclined from left to right indicate green, and vertical and horizontal lines crossed at right angles mean black (Fig. 3). Diagonal lines, right to left, stand for purple, and the same lines crossed in the opposite direction indicate orange (Fig. 4). The remaining color, dark red, represented by horizontal lines and diagonal lines, from left to right, is shown in Fig. 6. These seven are the only colors used as grounds in Heraldry.

The effect of a shield where the colors are indicated is given in Fig. 5. It is divided by a silver cross, on which is placed a green circular figure. The quarters are two red and two blue, and on the red two circular figures in gold. As before mentioned, every properly engraved shield should give the colors by means of the lines here indicated.

To be complete the coat of arms may consist of ten separate parts—shield, helm, mantling, wreath, crest, supporters, motto, garter, badge, and sometimes insignia. All these have a fixed position in heraldic arrangements.

HERE IS A WOOD FILLER.

Shellac gum one tablespoonful, powdered rosin one teaspoonful, beeswax of about the size of a walnut, all of which place in an iron pot and set on the stove until melted. Mix well together.

It may be used either in the liquid state or hard. Make it into sticks like sealing wax, by pouring it out on a board, a little at a time, and rolling it with another board, slightly warmed. Sticks of several colors may be made, ready for use. When ready to use it the stuff may be softened by holding over a gas or other light, then apply it to the parts that need to be filled; level up with a chisel, or putty knife, and smooth down with fine sandpaper.

This might answer for quick work on repairs.

GLUE.

The body builder has a high regard for good glue, although he does not always take the trouble to have it good, also hot, due to a tired feeling to which he is subject, like the rest of mankind. A writer in Wood Craft has some nice things to say about glues that are good to read over and refresh the memory:

Liquid glue is not necessarily made from fish, there are other sources, and there are various ways of making it. This is one way: Dissolve good glue in water and add a small quantity of nitric acid to prevent its gelatinizing without injury to its adhesive power.

Concerning the treating of glue and glue stock with chemicals I may say this is done not only for the purpose of clarifying it but also to increase its adhesive power, and it is not injured thereby. In clarifying glue all foreign matter is separated and thus it will be seen that the quality is improved instead of injured. This is one of the reasons why glue to-day is better than in the days of your grandpa.

Bone glue is made from bones and in many different ways. The stock for any glue must be treated with lime, acids, etc. This is done to remove certain foreign matter, to soften the stock, etc. The first stages of decomposition of glue solution are caused by its absorbing ozone. Glue solution left standing over night to cool will absorb ozone in slowly cooling. This is where the trouble really is; not in cooking it again unless it is cooked too often. I would not advise preparing any more glue into jelly than is required for the day's work.

It does not pay the gluemaker to use scrapings from the glue room. By the time there was enough accumulated worth the while of using it would be in such an advanced stage of decomposition as to be useless.

If one pound of glue absorbs $2\frac{1}{2}$ pounds of water, then we have 40 ounces of water absorbed and the glue is said to show a

water test of 40. Good glue should show a 96 water test, that is, it should absorb six pounds of water per pound of dry glue. There is no man that can remove all the moisture from glue unless he burns it to ash. This test would be deceptive at best, since glue may one day contain more or less moisture than the same glue the next day, all depending upon the atmosphere.

The tensile strength I should say would be better conducted in this way: Let two different glue users make a test from his own work. There will be found a difference, though the same glue, pots, etc., be used. Let each prepare the glue for his test.

FORMULA FOR COPAL.

Dissolve the copal gum on the water bath, at a temperature of about 100 degrees, in as much spirit as is required to make the proper fluidity. Or the gum and spirit may be placed in a closed vessel at a temperature of about 300 degrees. Here are two formulas for quick-drying copal varnish:

Formula 1. Turpentine one pint; alcohol one-half pint; mix, and add slowly under stirring powdered copal four ounces. Place on water bath at 100 degrees, and when dissolved leave the mass to settle, then drain off and decant.

Formula 2. Powdered copal eighteen ounces; turpentine three pints; copaiba balsam three ounces; alcohol one pint. Proceed as in formula 1.

THE YOUNG TRIMMER.

The first consideration of a trimmer should be a clean and orderly trimming shop, together with a full range of tools; the next, a fixed primary course of action; and last, a system of working by which the right thing is done at the right time. The pieceworker is usually an adept at short cuts; time with him is his chief concern, and although he does not enjoy much in the way of reputation as a close cutter of material, it is often because of the fact that he is a pieceworker, and any efforts he may use in this direction are not always credited to him. He is frequently much more systematic than the day worker. A man of experience, he will cut material to the best advantage, chiefly because it is no more trouble to him; and although you would not expect him to make a squab or cushion top of cuttings, if occasion warranted it, it would give him less trouble than might be imagined. To work so many stipulated hours each day, and to have really little in the way of incentive to get through a job in any given time, is not calculated to make a man exercise his brains and get the best results all round. Nor is the fact of a man being a day-worker any guarantee that he will be a close cutter, a fallacy by which many employers are misled. Employers are often at a loss to understand how it is that a man's time is not more consistent in repeating the same class of job, and many prefer a pieceworker as it enables them to arrive at a more uniform cost.

The materials used in the trimming shop are more expensive than those used in other departments, and anything that tends to reduce expense is naturally much to be desired. Aim at something higher than acquiring sufficient knowledge of your trade to enable you to earn the minimum wage; do not rely on any union for your advancement, as no man ever made any progress from anything the union ever taught him in connection with work or method of working; they have nothing of the kind to offer you.

Classify your cuttings, and put them into wrappers. Keep your small cuttings down by having them prepared for ordinary routine work, floorcloth cut into strips, and designs for raised work, patent leather into breeching and kicking leathers, and all strips of duck and leather for piping and binding. In all shops there are standard jobs turned out, for these have a uniform set of patterns, as well as fall backs, and cushion fronts, with raised work ready for material.

McKay & Co., Jacksonville, Fla., have opened a carriage repair and blacksmith shop.

VULCANIZING CARRIAGE CLOTH.

Rubber covered cloth for upholstering seats and covering the tops of automobiles and other carriages, as it comes from the calender, is of a dull dead black or brown color, similar to the finish found usually on rubber boots and rubber blankets. While this sort of finish is suitable for some classes of work, most users require cloth with a small raised design or impression, to add to the appearance of the made-up article. In compliance with these requirements, four styles of impressions are rolled in, from which to choose.

1. The pinhead pebble. The name describes it quite well. The cloth looks as though it were just covered with pinheads scattered every way about 1-32 inch apart.

2. Long grain. This grain is quite popular with the automobile body manufacturers, and it looks as though marked all over with the point of a pin, apparently no regular design being carried out.

3. English. The English grain is gaining rapidly in popularity. The raised lines are about 1-16 inch wide by 3-4 inch long, and all run one way; that is, no two lines cross. It might remind one living near salt water of the rills left in the sand by the action of the waves when the tide falls.

4. Flat grain. This is the hardest of all to describe. The lines are about 1-16 inch wide and very short and crooked, being scattered over the cloth close together and running every way.

In order to give the cloth this finished appearance it is run through a mill having two steel rolls about 18 inches in diameter and about 5 feet long. The top roll is engraved the reverse of the design that is desired on the cloth. Generally this is rolled in with a knurling tool, but sometimes a secret process is used, the main point of which is that the work is done by an etching

acid that eats parts of the steel roll that is not covered with wax, says Frank B. Lucas, in *The India Rubber World*.

The bottom roll is of the same diameter as the top one, but the surface is a layer of compressed paper. To make the bottom roll have impressions that will just match the top roll is imperative; therefore the top roll is heated and the two rolls squeezed together, rolling the impressions into the lower or paper covered roll. This paper impression is called the matrix.

The cloth in 100 yard lengths taken from the calender is put on an arbor in the front of the machine and then fed through, automatically winding up on an arbor at the back of the rolls. Although the compressed paper covered roll is nearly as hard as the steel one, still when the cloth comes out the impression is on the rubber side only, leaving the cloth back perfectly smooth.

As for the vulcanizing process: The rolls of impressed cloth are loaded upon a truck made especially to carry six rolls—three on each side, supporting them by the ends of the arbor through each roll—and taken to the vulcanizing room.

The two machines shown in this room are for varnishing and carrying the rubber cloth to the vulcanizer. The cloth goes under the varnish rolls, then up to the top of the machine. Here it is transferred to a traveler that carries it into the vulcanizing oven. The cloth then goes over the ends of the machine, and when near the floor is again caught up by the traveler and a second loop carried into the vulcanizer. This is continued until that section of the oven is full. The machine is then pushed to the next section and the same operations are continued.

At the extreme left corner of the room is the door that opens to the vulcanizing room, and as there is a fireproof wall between the two departments the danger of destroying the finished cloth, should fire break out in the vulcanizers, is practically nil.

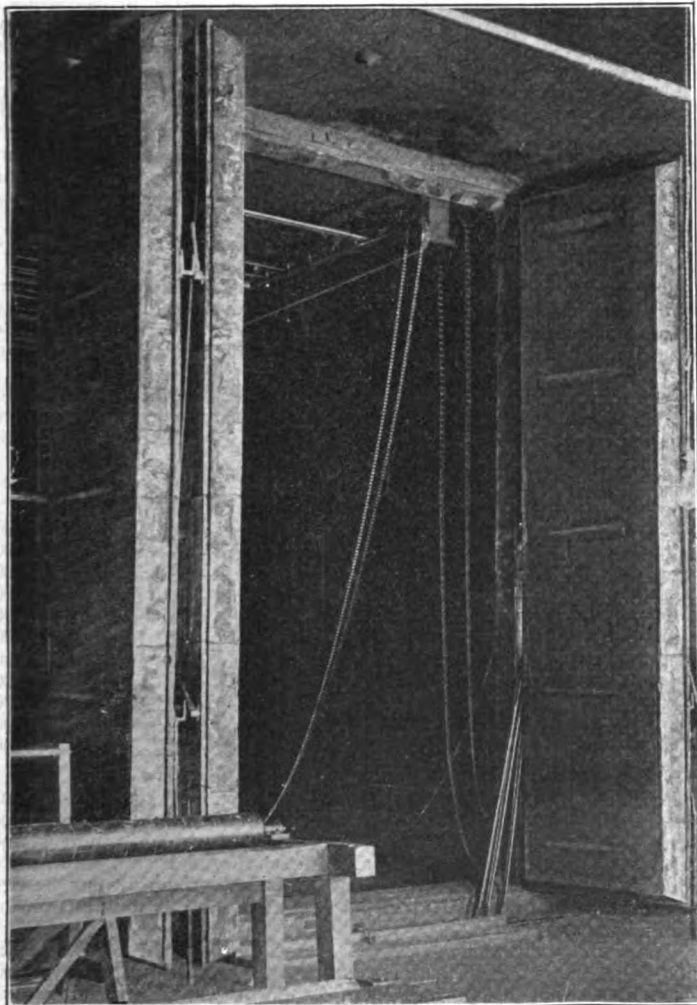

Dry Heater for Carriage Cloth.

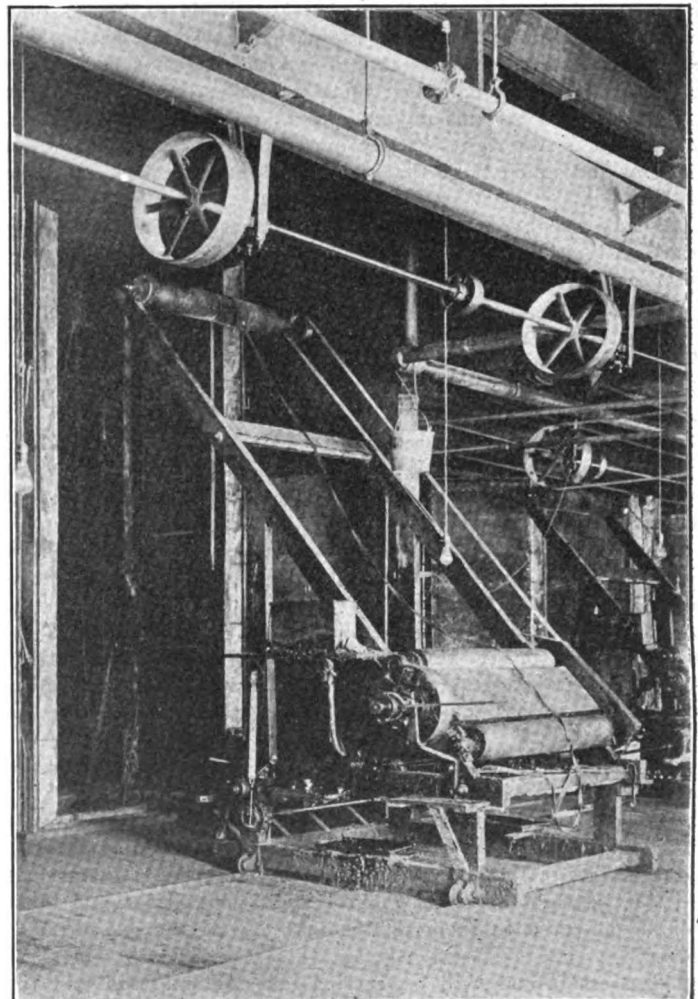

Varnishing and Festooning Machine.

Courtesy India Rubber World.

C. B. N. A. CONVENTION BULLETIN.

Official Information for Exhibitors at Cincinnati Convention, September 26 to 29.

To Members of the Carriage Builders' National Association:

We invite attention of all members who purpose making an exhibit this year to the notice for the exhibition and the rules governing the same. Important changes have been made.

You will notice that the minimum space is now 8x8—\$20.00.

That the exhibits must not be dismantled or removed, nor any preparation for removal made until Friday morning, September 30.

Also, that no nails or screws shall be used in fastening your exhibit or railing to the floor. A pine board can be laid down on the floor and the exhibit or railing fastened to this, which will make it secure. This is a "drill floor" and we could not have obtained the hall unless we guaranteed it should not be injured in any way. Please notify your representatives that this order must be strictly observed.

All exhibits must be taken out on Friday the 30 of September, as the lease expires on that day.

We would suggest that you notify your representatives to stay with your goods and see that they are properly delivered to the transfer company for shipment. No other persons can do this nor tell if all have been shipped. This will prevent confusion. No one can tell to whom they belong, or where they are to go, nor can any one tell if they are properly cared for, unless the owners stay by them until they leave the hall.

We invite your attention to the following extracts from the minutes of the Executive Committee as published:

"In relation to the order made at the Chicago convention relative to soliciting orders on the exhibition floor, the Executive Committee desires to call all members' attention to this, as they think a moment's reflection on the part of those not having any exhibit, will convince them that it is unfair to those who have made the exhibition hall their office and salesroom for the time being, and paid for this opportunity to meet the vehicle trade, and that it is not right for any one not exhibiting to come on the floor and solicit trade that rightly belongs to those who have exhibits.

"As any member can secure space at these exhibitions if they desire to look for trade at same, they should take space and be on an equality with those who do.

"All members are welcome to visit the exhibition, but fairness to those who pay for the privilege of exhibiting should prevent all from making unfair use of this privilege."

The following resolution was passed at the convention at Chicago in 1908:

"Resolved, That the secretary of the C. B. N. A. be instructed by the association to adopt such regulations as to exclude from the exhibit hall all representatives of the accessory trades that are not members of the Association.

"Resolved, That the exhibitors and their representatives be furnished with a badge showing they are exhibitors or representatives of the same."

In accordance with the above resolution, the Executive Committee, the Associate Members Association, and the secretary as ordered, have arranged that the admission to the exhibition hall shall be by ticket, to be procured at the entrance door on registration.

This ticket will be provided free to all members of the association, both active and associate.

And also to all carriage, wagon, sleigh, automobile and motor car builders who are not members of the association.

The exhibitors will be provided with badges for themselves and their attendants as the above resolutions call for, and these will be delivered to them on the first day of the exhibition is open.

These resolutions will be carried out and enforced and the secretary requests the co-operation of all the members in having this done.

We would also suggest that you instruct your representatives to carefully obey the rules as printed, and we will send you as many copies as you may need to provide enough for this purpose.

By order of the executive committee.

HENRY C. McLEAR,

Temporary address, Mt. Vernon, N. Y.

Secretary.

READ RULES CAREFULLY.

For exhibition purposes the committee has engaged the Ohio National Guard armory, 1419-1431 Freeman Avenue, a large and well lighted hall that will accommodate all who wish to make a exhibit.

The following rules and regulations have been adopted to govern the exhibition:

Exhibitors must be confined to models, parts of vehicles or automobiles, and to materials used in the construction of the same, or to coachmen's outfits, harness and horse furnishings. No finished vehicle will be admitted.

This exhibition is the members' own exhibition. They can take what space they may wish, from 8x8 to 20x100, or larger, if they desire, and as the exhibition is entirely for the benefit of the members, and as we never know their desires about the size of space they will need until the application is received, and also on account of the manner in which the space is sold—by mail only—it is impossible for us to make a diagram of the hall. For these reasons we cannot allow each one to choose his own location when making application for space. You can readily see, if we had a diagram sent out by mail, several might choose the same location, and by so doing, lead to endless confusion.

Therefore, no definite location can be allotted to any exhibitor on receipt of application. The space will be allotted in the order applications are received, and arrangements can be made when installing exhibits to group industries that desire to be so treated. Those making early application to the secretary will secure what advantage in location there may be, and also avoid the delay in securing their space on the day of opening. As far as possible, ample room will be furnished to all.

The committee will arrange to have the exhibition space policed by day and watched by night, for the better protection of the exhibits, but cannot and does not assume the responsibility for loss or damage, from any cause, so far as individual exhibits are affected. The exhibitor must arrange and care for his exhibit, and he must assume all responsibility therefor.

Exhibits can be placed in position on Friday, September 23, and Saturday, September 24, and the exhibits so placed must not be dismantled or removed from the exhibition hall nor shall any hammering or unnecessary noise be made in preparation for removal until 6 o'clock P. M., on Thursday, September 29.

And this rule is ordered strictly enforced.

All exhibits must be removed on Friday, September 30, as the lease expires on that day.

The exhibition hall will be opened at 8 o'clock, A. M., and remain open until 6 o'clock, P. M., every day from Monday the 26th, to Thursday, the 29th, and will be open all day Friday, the 30th, for the removal of the exhibits, which must be removed on that day.

As much of the hall as will be required will be marked off into 8, 12 and 20 feet wide sections, and aisles arranged about the reservations as liberally as the character of the floor space of the hall will permit.

The space will be sold according to the following scale of prices:

| | |
|------------------------------|--------------------------------|
| 8x 8 feet—64 feet... \$20 00 | 12x12 feet—144 feet... \$45 00 |
| 8x12 feet—96 feet... 30 00 | 12x16 feet—192 feet... 60 00 |
| 8x16 feet—128 feet... 40 00 | 12x20 feet—240 feet... 75 00 |
| 8x20 feet—160 feet... 50 00 | 12x25 feet—300 feet... 90 00 |
| 8x24 feet—192 feet... 60 00 | 12x30 feet—360 feet... 110 00 |
| 8x28 feet—224 feet... 70 00 | 12x35 feet—420 feet... 125 00 |
| 8x32 feet—256 feet... 80 00 | 20x20 feet—400 feet... 120 00 |
| 8x38 feet—304 feet... 90 00 | 20x25 feet—500 feet... 130 00 |
| 8x42 feet—336 feet... 100 00 | 20x30 feet—600 feet... 180 00 |
| 8x46 feet—368 feet... 110 00 | 20x35 feet—700 feet... 210 00 |
| 8x50 feet—400 feet... 120 00 | 20x40 feet—800 feet... 240 00 |

The charge for larger space will be in the same ratio.

Exhibitors desiring specially arranged spaces, both as to number of square feet and unusual dimensions, can be accommodated by early application to the secretary. Additional space to that already granted may also be arranged for, if exhibitors will forward applications for such additional reservations before the date fixed and published in this manual for installation of exhibits.

Floor and wall space only will be sold. This may be furnished by the exhibitor with desk, chairs, tables, railing, etc., to suit his needs. But the committee or its employees cannot undertake to furnish any of these articles, although a list of well recommended local dealers, carpenters and decorators may be had by

application to the superintendent of exhibits, who will do all possible to facilitate the supplying of the needs of exhibitors.

No nails or screws shall be used to fasten the exhibits or railings to the floor. This rule must be obeyed and arrangements made by laying a board on top of the floor to fasten the exhibits or railing to. This can easily be done and at a very small cost. The floor must not be damaged in any way, as we have contracted this shall not be done.

Space about the sides of the hall of exhibits will be devoted, as far as possible, to exhibitors requiring wall space for standing, hanging, paneling or displaying in booths, that are wholly or partially enclosed. No booths of this character will be permitted as part of an exhibit in the clear space of the hall, if it shall obstruct vision by being enclosed, or be objectionable because of the arrangement of signs that interfere with the rights of other exhibitors, whose protests will be accepted as final and binding on the exhibitor so offending.

The space allotted to any exhibitor, must not be sublet to anyone not members of the association. This rule is imperative.

No signs in the body of the hall shall be so displayed as to interfere with a proper observance of community interests. It must be an implied agreement on the part of exhibitors when reserving space, that the secretary, or the superintendent shall be the sole and final judge of infractions of this regulation, and his decision shall stand.

Any damage to the building by any of the exhibitors must be settled for before the exhibits are removed from the building.

The association assumes no responsibility whatever for care of exhibits, boxes, crates, etc., other than to furnish such assistance to exhibitors as will enable them the more quickly to install exhibits, and to remove the crates to a storage place where they are to remain as a matter of convenience to exhibitors, and at their risk, although the usual precautions, as stated elsewhere, will be taken to safeguard property as a whole.

Applications for space should be made to the secretary now, and should state the nature of the exhibits, as well as the space required. As far as it is possible the space will be assigned in the numerical order of receipt of application. The sure and only method of securing the best locations is to make early application.

Payment for the space taken can be made with the application, or, if the exhibitor prefers, can be made at any time prior to September 10. Receipts for same will be returned by the secretary, and said receipts will be received as voucher for space, when presented to the superintendent at the hall.

We would suggest that goods sent for the exhibition should, if possible, be sent express prepaid. If forwarded by freight from distant points, experience has demonstrated that there is no surety that goods will arrive when wanted, unless they are shipped at least one week before the time the freight agent declares is ample time for the shipment. The freight should be prepaid if prompt delivery to the hall is expected, after goods reach terminals.

Mark goods plainly, and in more than one place on the package or crate, as directed below, and be very careful to also mark on the package the name of shipper also. This precaution aids the committee in identifying goods in owner's absence, aids quick installation on spaces ready for exhibitor, and prevents loss by reason of non-identification.

Mark as follows: "Carriage Builders' National Association Exhibition, Armory of the Ohio National Guard, 1419-1431 Freeman Avenue, Cincinnati, Ohio."

For bulky exhibits, too large to send by express, arrangements have been made with the McDonald Transfer Co., 43 Main street, Cincinnati, Ohio, to receive and transfer the articles intended for the exhibition, from the freight stations to the exhibition. Should you desire them to take charge of your goods we would advise you to notify them when goods are sent, the route, and if possible send them duplicate bill of lading.

The Executive Committee requests all exhibitors to be sure that they quote prices only to vehicle manufacturers.

The president of the association will appoint a "special committee on exhibition" to examine the exhibits and make report to the convention of such articles as show improvement in their special lines, or show a high order of inventive ability.

By resolution passed at the annual meeting held in New Haven, Conn., October 17, 1883, it is required that any firm or company wishing to exhibit goods at the convention should have at least one of its partners or officers a member of the association; and the fact that a representative or employee is a member will not alone be sufficient.

Extracts from the Constitution. Article III.

Section 1. The members of this association shall be persons engaged in manufacturing or selling vehicles for pleasure or freight.

Section 2. Associate members may be elected from any trade or profession pertaining to the vehicle trade, upon the payment

of the dues, prescribed by the By-Laws, which shall entitle them to all privileges of the association (including the annual dinner), excepting a vote on the election of officers.

Extract from the By-Laws:

"The annual dues shall be \$10, payable in advance."

Applications for membership should be addressed to Henry C. McLearn, secretary, Mount Vernon, N. Y.

AS AMESBURY SEES ITSELF.

The one great fear of the town is that the automobile business will go west, the same as the carriage business did, but there is nothing being done to stop it if it should. The cheapness of labor and materials in the west gradually undermined the eastern firms, and now most of the carriages built are made in the middle West. Fortunately we had the auto to take the carriage's place, but the West has been making strenuous efforts to land the making of these. As autos are sold at a price that demands the best of labor, the auto body building still stays in the East, however.

As they couldn't land these industries that way, Detroit, Cleveland, Toledo, Columbus, Indianapolis, etc., have organized Booster clubs, with anywhere from forty to one hundred thousand dollars for an emergency fund, urging them to locate in their cities, showing them the advantages, particularly in freight and express rates, and even offering to build factories for them if they should move. The moving of the Atwood Castle Co. from here is a result of such a campaign, and of late very tempting offers have been held out to Gray & Davis, Amesbury Metal Body Co., Hasset & Hodge, and Biddle, Smart & Co. In fact, practically every firm in town has received offers to remove to one of these places.

We can't have a club with a fund of that amount, but if we could even have an association without any funds that would try and get new industries here and also to keep what we've got, it would certainly be a move in the right direction.—Amesbury Exchange.

FATE OF THE HOOKER CONCERN.

Just what disposition is to be made of the Henry Hooker Carriage Company, of New Haven, Conn., as a result of the proviso in the will of the late Edwin Marble is still a matter that has not yet been settled. Mr. Marble, who was the president of the carriage company, one of the oldest of such firms in the East, made a will in May, 1900, in which he stipulated that the business in which he held the controlling interest should be carried on for ten years from the date of May 29, 1900. The income from the controlling interest in the business he provided should after his death (in 1903) should go to his heirs. It is now more than a month after the ten years' agreement has elapsed as provided for in Mr. Marble's will.

CREDITORS MEET.

A meeting of the creditors of the Elgin Wagon Works of Dundee, Ill., was held. From information received it is learned that Judge Utt, of Chicago, is now financing the plant. The Elgin Wagon Works emerged from the Rock Falls Wagon Works, which became involved in financial trouble it is said. These claims are now being adjusted. All claims against the company, it is said, will be met in full. Sixteen men are employed by the company.

GOING INTO GAME.

The Kendallville Buggy Company, Kendallville, Ind., is making preparations to enter the automobile industry. The several parts have been received which will be assembled at an early date and will be given a trial, which, if satisfactory, the company will proceed to manufacture. The company had expected to construct a small number of cars this season, but as it was unable to secure the necessary parts the work will be postponed until another season.

A WAGON BED OF MANY USES.

A convertible wagon bed which can be changed into fifteen different kinds of bodies for different uses around a farm, without adding to it or taking from it a single piece, has been de-



Party Wagon



Market Wagon



As a Hay Rack



Unloading Corn



Livestock Bed



Load of Baled Hay

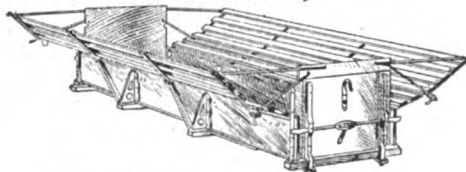

Wings Extended for Use as Hay Rack

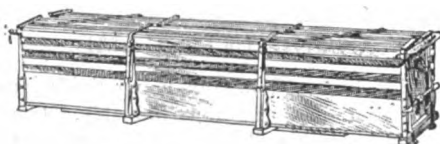

Wings Folded Over for Hogs, Sheep, Etc.

signed, and is undoubtedly the most radical improvement made in farm wagons for a decade.

In a few minutes it can be transformed from a hay rack into a wagon for carrying livestock, and with equal quickness it can

be converted into a vehicle for carrying a large number of passengers who can be provided with comfortable seats along the sides for picknicking, etc.

The remarkable versatility of the new wagon bed is secured by hinged malleable iron pieces attached to the sides. These support two folding sections on each side. The strain which is put upon these pieces when heavy loads are placed on the wagon makes it imperative that they should be of strong dependable material.

The agriculturist has often found it a hardship to be obliged to buy or build a number of wagons for the multifarious requirements incident to the operation of a farm. The wagon that would serve to carry boxed or crated vegetables and berries to market would not be of any use when haying time came around. When it was necessary to carry calves or livestock, still another wagon must be called into service.

While reapers, threshers, and other farm implements have been continually improved, the farm wagon has remained practically at a standstill. Perhaps the fact that the automobile has made such wonderful progress has served to overshadow the humble beast of burden and his reliable wagon. Old Dobbin may be a second rater now, but he will continue for some time to fill his particular sphere of endeavor with a faithfulness which the motor car cannot always be relied upon to give.

RECEIVER FOR JEWEL MFG. CO.

Charles F. Pratt and O. M. Baker were appointed receivers of the Jewel Carriage Company, at Carthage, Ohio. The appointment was made in a suit filed by Albert E. Schafer, owner of 972 of the 2,500 shares of \$100 each and a creditor to the amount of \$4,860.

At a meeting of the creditors on July 1 it developed that the failure was more serious than at first supposed. A proposition to settle on the basis of 50 cents on the dollar, on notes to run from December, 1910, until December, 1911, was refused by the creditors, who named the following committee to investigate the situation: E. J. Hess, D. W. Rodgers, E. G. Schultz, Fenton Lawson and W. H. Lynch.

The financial statement submitted shows assets of \$579,246, and liabilities of \$323,578, exclusive of the capital stock. The statement reveals the embarrassment in the showing of fixed investment in real estate, buildings, machinery, tools, fixtures, dies, patterns, sprinkler system, etc., of over \$203,000, while there is \$291,903 in merchandise, stocks and supplies on hand. This is carried on a capital of \$250,000. Among the assets are \$3,500 of bills receivable, \$70,647 of accounts due and \$4,789 of cash on hand.

The liabilities account shows \$250,000 for capital stock paid in, \$11,250 mortgage indebtedness on the property, \$100,309 in the bills payable account, \$121,518 in the general accounts payable and \$30,500 owing to banks. All of this indebtedness except, of course, the mortgage, is unsecured. There was \$115,000 in new cash capital placed in the business at the first of the year when the manufacture of automobiles was added. The company was seriously embarrassed by cancellation of orders, due to inability to fill them by reason of the failure to secure delivery of supplies.

HOOVER CATALOGUE.

The Hoover Wagon Co. has one of the most convenient catalogue arrangements likely to be devised by anyone. The line of wagon work made by the concern is frequently changing and increasing, and to issue new catalogues would be quite a burden of expense. Now, with the bookbinding covers, on loose-leaf lines, it is easy to have for constant reference, in its proper division all the new work. The initial cost is somewhat large, but the comfort and convenience of customers are served, and the arrangement is in the end economical.

GRAPHITE LUBRICATION.*

By E. G. Acheson.

Graphite has not, comparatively speaking, been known for many years as a mineral separate and distinct from those which it resembles. My own work has been devoted to its artificial production, and when I say 'artificial,' I would explain that while many may interpret the word artificial to indicate an imitation or a sham, it is when applied in this connection intended to mean "produced by man," the graphite made by my process being in every respect as genuine as the natural, and in view of the fact that in the manufacture it is possible to control all of the conditions governing its production we are able to produce graphite of a purity far beyond that found in nature.

While making an experiment I noticed in the output of an electric furnace a small amount of a very soft, non-coalescing graphite which I recognized as being of a character that would make it valuable as a lubricating graphite. Following up the discovery of this small amount of soft-non-coalescing graphite I worked out methods for the commercial manufacture of this product.

This new product has received the number "1340" and by this number it is known to-day on the markets. The company manufacturing it guarantees it to have a purity of at least 99 per cent, whereas they know and take great care that none shall go on the market that has not a purity of at least 99½ per cent. The small amount of impurity still remaining in this graphite consists of condensed metallic vapors.

Reduced to a state of disintegration so fine that 99 per cent of it will go through the meshes of a sieve having 40,000 meshes per square inch, it can in some cases be used dry, but more generally when mixed with greases it can be used in ball bearing races, transmission cases, grease cups and, in fact, any place where it has been the custom to use plain greases. This graphite grease product is now placed on the market under the trade name of "Gredag."

It occurred to me that probably the treatment to which I had subjected clay to increase its plasticity and strength might have a similar effect on graphite, this treatment having made the clay so fine that it would remain permanently suspended in water and pass through a fine filter paper. This effect is not produced, as one would suppose, by an ordinary grinding process, but is simply produced by mixing a solution of tannin with the graphite. When the solution of the organic matter is added it wets the graphite immediately. I think that this affinity extends beyond the wetting of the surface of the graphite and actually carries the liquid into the body of the graphite, exerting force sufficient to break asunder the flocculated particles of graphite, thereby reducing it to a deflocculated condition.

I have here before me a bottle of graphite in water, the graphite having remained in suspension in the water for more than a year without any indication of settling, and this notwithstanding the fact that the graphite weighs approximately two and one-quarter times that of the water in which it is suspended.

In the process of preparing deflocculated graphite for practical purposes it is first diluted with a vast amount of water, so much indeed that the water is carrying no more than three-tenths of one per cent of its weight, and this is run into large tanks, allowed to stand for one hundred hours to permit of any possible settling, then decanted and the water removed, leaving the deflocculated graphite in the form of a paste, composed of approximately fifty per cent graphite and fifty per cent water. This is accomplished by running the graphite and water into a filter press whose filtering medium consists of sheets of canvas which have been dipped in a solution of rubber in gasoline and afterwards dried of the gasoline, the rubber forming delicate films in the mesh of the canvas, and through this rubber film the water, under a head of thirty pounds pressure, will readily

pass, although slowly, while the deflocculated graphite is retained in the filter as a paste.

I succeeded in transferring the deflocculated graphite from the water to an oil by several methods of procedure, one of which is to place the paste of deflocculated graphite in water in a suitable mixing or pugging machine and add a good grade of lubricating oil to the paste in small additions, until eventually the contained graphite has been greased or oiled and the water thrown out, leaving the deflocculated graphite in the form of a paste with oil.

Placing a little deflocculated graphite water in a test tube and adding water, a slight shake puts the graphite in suspension. If into a second test tube there be placed a small quantity of deflocculated graphite as a paste with oil and to this be added some kerosene, upon shaking the graphite goes into suspension in the kerosene. In these two tubes we have two new lubricating bodies.

My artificial graphite has received in the commercial world the name of Acheson Graphite, and looking about for suitable names for these two new lubricants I have taken the initial letters of deflocculated Acheson graphite to form the suffix "dag," which I have added to Aqua in one case and Oil in the other, producing the new words "Aquadag" and Oildag."

Having succeeded in producing Aquadag and Oildag it now became necessary to determine their efficiency as lubricants and the amounts of deflocculated graphite contained in the suspending medium that would produce the best results. From experiments conducted upon a Carpenter oil testing machine using an automobile cylinder lubricating oil, proved the presence of deflocculated graphite very materially improved its lubricating qualities and that graphite to the amount of one-half of one per cent of the weight of the oil gave better results than one per cent graphite, and from these and other tests I adopted as a standard mixture an oil carrying 0.34 of 1 per cent of its weight in deflocculated graphite.

The earliest practical use of Oildag was in the lubrication of the cylinders of automobiles, and these were first conducted in my own machines and have now extended over a period of approximately three years. One of these machines has now covered 23,000 miles, while the aggregate of the three machines amounts to more than 42,000 miles on their own power. During this entire period and distance there has not been occasion for the regrinding of any one of their valves, nor has there been a spark plug cleaned or renewed.

I believe it is the usual practice under the advice of the builders to use approximately one gallon of oil to lubricate the cylinders for every two hundred miles covered by the machine. When I introduced Oildag into the car after operating for a short time—say 100 miles—it was found that the oil level, as advised by the makers, had risen, and to keep it down it was necessary to reduce the feed to the crank case. After operating a still further distance it was necessary to again reduce the feed and this process was continued, always keeping the oil level constant so that the splash was as recommended and practiced by the builders, until the feed had been so much reduced that the car was operating a distance of 750 miles while consuming one gallon of Oildag, or three and three-fourths times the distance possible when using plain oil. In addition to the above cited advantages of non-pitting of valves, reduction in oil consumption and consequent absolute freedom from smoke in the exhaust, even when the crank case was flooded (as I intentionally once did in order to test the matter), it was found that the engines were developing more power than they had been designed for and intended to do.

The battle cry of the oil interests—"The use of Oildag causes a carbon deposit in the cylinders of an automobile"—is constantly coming up before me. It becomes necessary to analyze this statement and find out whether or not it is true. Oil carrying 0.35 of 1 per cent of its weight in deflocculated graphite has the equivalent of one cubic inch of solid graphite distributed throughout three gallons of oil, constituting the product of Oil-

*Extract from paper read before the National Gas and Gasoline Engine Trades Association, Cincinnati, June 15, 1910.

dag, and if these were consumed at the above stated rate of one gallon for every two hundred miles, the car would operate a distance of six hundred miles before the first cubic inch of graphite would pass by the piston rings into the combustion chamber and if all this cubic inch of graphite were to be condensed, collected and fixed to the heads of the pistons in the four cylinders, none of it being allowed to escape into the exhaust or become fixed to other parts of the cylinder walls or heads, it would produce a layer of pure graphite about one hundred and twenty-six thousandths of an inch.

Several of the best satisfied users of Oildag in automobile engine lubrication follow this practice: They started in at first using oil carrying the amount of graphite that is specified on the packages in which it is put up, and after they have run sufficiently long (perhaps eight hundred to one thousand miles), to produce a fair veneer of graphite on the cylinder walls and then use Oildag carrying but one-half the amount of graphite the makers specify; in other words, an amount of graphite equal to one cubic inch in six gallons of oil. This small amount is sufficient to replace any wear that may occur on the veneer and more than that is not necessary. Following this practice you would have to operate the car 4,500 miles before one cubic inch of graphite has entered the combustion chamber in a free state that would permit of its being deposited on the top of the piston, the head of the cylinders or about the spark plugs.

A matter of much importance, but one frequently ignored by the owner of an automobile, is the cost of the oil used to lubricate the cylinders of his machine, and this I will venture to comment upon in this manner. Under the usual practice, for instance of a Packard 30, one gallon of lubricating oil is used for every 200 miles covered in the operation of the machine, and assuming that the oil costs 60 per gallon, the operator has to pay \$30 for fifty gallons necessary when operating 10,000 miles. I have found in my own practice that this 10c worth of Oildag paste when mixed with one gallon of oil, is sufficient to make lubrication for 750 miles, and this works out to be \$1.33 1-3 worth of paste for 10,000 miles, and during this distance—if the same results are met with that I have been attaining—the total amount of oil consumed would be less than one-third as much as would be necessary with plain oil, bringing the cost of the oil below \$10, making a saving of more than \$20 in oil. From this you will see that the cost of the Oildag is much more than covered by the saving in oil.

In glancing back over what I have said I will venture to collect in a more condensed form the advantages to be attained by the use of Oildag in the lubrication of an automobile engine:

1. Increased power.
2. Prevention of pitting of the valves.
3. Prevention of the smutting of the spark plugs.
4. Decreased oil consumption.
5. Decreased gasoline consumption.
6. Absolute freedom from smoke in the exhaust.
7. Prevention of wear between the cylinder walls and piston rings.

Decreased amount of carbon deposited in the cylinders.

Practical elimination of the abrasive action of the carbon set free from the oil.

OIL THE SPRING SHACKLES.

The amount of lubricant used up by spring shackles is astonishing, although the fact must not be overlooked that these joints are constantly at work while the car is running, with an action that tends to drive the lubricant from the surfaces that carry the load.

CUTTING HIDES FOR TOPS.

In cutting a hide for a top, cut the top quarters across the butt, and the roof in the same way, which leaves the back curtain; then cut the side curtains in the neck.

SHOP TRANSMISSION HINTS.

We forget the steady, continuous pull of ten hours a day and the strain and wear of hard usage day after day, year after year, till something gives out and has to be repaired; then we are sorry that we did not buy better, stronger and heavier at any price. For instance, the hangers and bearings on the line shafting should be the strongest and heaviest, and the shafting should be at least ¼-inch larger than one's best judgment tells him to get. The reason for this is obvious; the larger the shaft the better grip the pulleys have, the less vibration and the steadier running line we have; it is easier on the bearings, there is less danger of heating, and, best of all, the large shaft is so much easier to keep in line—in fact, it is next to impossible to keep a shaft in line that is a little on the small side.

Bearings should be long and heavy and hangers large and strong, and so constructed that the bearings may be easily removed to clean or scrape, should any of them get to heating, but at the same time so constructed that the bearings may be securely fastened that they will not work loose in the months of continuous strain and jar they must be subjected to. Everything else about the plant should be put in the same way, that it may be permanent and not require replacing and repairing often.

A mistake frequently made is in putting up belt shifters. These are generally slighted. Almost any kind of makeshift arrangement is put up so long as it will answer the purpose—and in a short time it is giving no end of trouble. I find that the belt-shifters furnished with pressed steel counters are next to worthless, and I discard them altogether and put up substantial ones of hardwood, fastened securely to the ceiling. Thus I am able to put them right in close to the tight and loose pulleys, which cannot be done when the rod is supported on the hangers, as the rod must pass outside the large pulleys. A belt-shifter properly constructed means added years to the life of the belt.

Another point: In putting in bearings for shafting, pin your faith to a good ring-oiler reservoir bearing.

RE-CLAIMED RUBBER.

The India Rubber World points a suggestive paragraph that shows much of the rubber now in use will in time be back in the channels of trade. We quote: There are those who put the blame for the notable increase in the price of crude rubber upon the automobile tire, and it is without doubt the enormous expansion in that line has caused the advance. Millions of dollars worth of rubber have gone into tires, tires that are to-day in use or in store, and that rubber is therefore withdrawn from all other manufacturing possibility. Such withdrawal, however, is only temporary. In one, two or three years 90 per cent of all this rubber will come back to the manufacturers through the reclaimers. It will not be "shoddy" by any means, but a high grade recovered gum that can be used in almost any ordinary rubber work as safely as the better grades of crude rubber. And it is on this great aggregation of stored up rubber that manufacturers can count, to obviate not only a further increase in the price of crude rubber, but a perpetuation of the present abnormal condition as well.

GOOD MAIL WAGON CONTRACT.

The Hoover Wagon Company, of York, Pa., has completed four of the largest screen mail wagons ever built in the United States, each vehicle weighing over two tons. Two were sent to each of the cities of Los Angeles and San Francisco, California. Although the factory is building many kinds of vehicles it is particularly busy on this kind of wagons. Little Rock, Ark., will receive six of this grade, while four have been consigned to each of the cities of Seattle, Wash., and Kansas City, Mo. Three other mail wagons were sent to Oklahoma.

Henry B. Schwartz, New Haven, Conn., has opened a new carriage shop.

ILLUSTRATING DIFFERENTIAL WITH HORSE VEHICLE.

To explain the action of the differential applied to the real wheels of chassis a correspondent uses the horse-drawn vehicle for his illustration. We find it thus described in The Motor (London).

A horse, whether walking or trotting, attached by a collar and traces directly to a load, twitches it a little, first on one side and then on the other, after overcoming the initial inertia. Any one sitting on the front seat of a four-wheel carriage, where the axle is directly under the seat, will see the axle move backwards and forwards past any fixed point on the body, say the step iron, from half inch to one and one-half inches, at each step of the horse. This is due to the shoulder action, the distance through which this particular movement takes place is largely due to the driver, with a horse of average stride. If the horse is attached to a swivel tree this action of the axle is prevented,

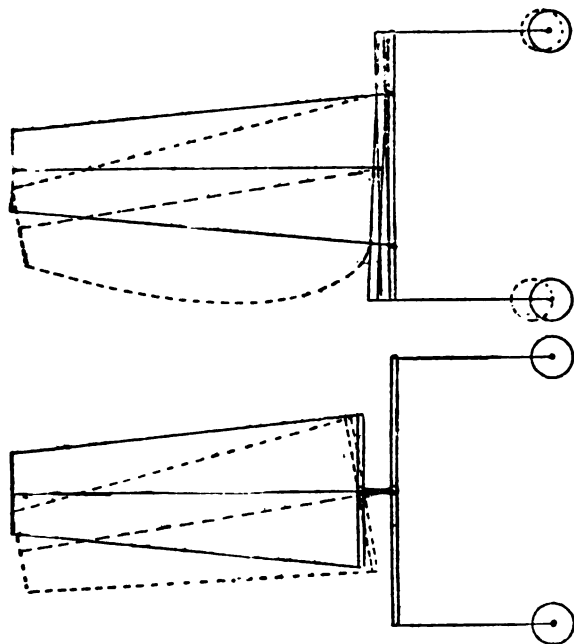

Figs. 1 and 2.

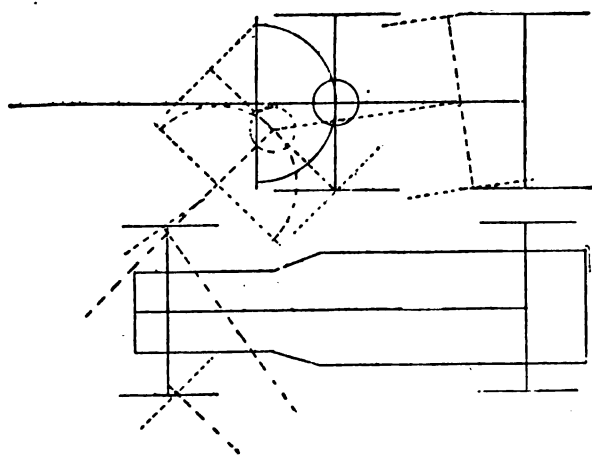

Figs. 3 and 4.

for the power is applied to both wheels all the time, provided the horse be suitably harnessed to the carriage and carefully driven.

Fig. 1 shows the movement of a splinter bar as described in a series of alternate jerks. Of course in practice the progress of the weights, shown by dotted line, would be very irregular. Fig. 2 shows the same arrangement but with a swivel-tree attachment; here the progress of the weights would be regular all other things being equal. In turning Fig. 1 the stress would be on the outside trace, the inner one dropping slack until the bar

was at right angles again, the outer weight covering more ground than the inner. In turning (Fig. 2), the power being applied directly at the centre, the connections between the bar and weights would not remain at right angles or regain that position until the direction in which the power was being applied was at right angles to the splinter bar.

Figs. 3 and 4 show what happens when the front wheels of a horse-drawn carriage and a motor car are set at the same angle to the axis of the carriage. In the carriage, the near side wheel being turned, as on a pivot, the axis of the carriage is altered, and the rear wheels drawn forward and inclined in the direction in which the front wheels have been turned. Although one front wheel has not revolved, the outer one has moved a greater distance than its diameter, rather more than one-third of a revolution. In the car the front wheels have described part of a circle, the radius being the length of the pivot arm, negligible but the axis of the car remains the same. It is assumed that both carriages are standing still, and to turn this axis in the direction which the wheels are taking will stress the back axle and wheels unless some relief be provided. The differential steps in and enables the outer wheel to move faster than the inner one. Of course in practice no one thinks of turning the wheels full lock before starting, the opening of the curve is gradual and there is less stress on the rear axle.

RECEIVERSHIP TANGLE.

By no means the last has been heard of the Electric Vehicle Co., of Hartford, Conn., judging from the nature of an order on June 17 by Judge Cross, of the United States Circuit Court for the District of New Jersey. Although in practical affairs the company has been succeeded by the Columbia Motor Car Co., the receivership manifestly is destined to linger for some time to come, if for no other reason than that the Selden patent controversy involves the Electric Vehicle Co.'s relations to George B. Selden and to the Columbia Motor Car Co., and the receivers will be continued until these relations are clearly established in court. Henry W. Nuckols and Halsey M. Barrett, the receivers have filed their seventh report, dated June 16, and the court order is for creditors and stockholders to show cause, on June 27, at the State House in Trenton, N. J., as to why the report should not be approved and the receivers permitted to follow out the recommendations and course of action that they have outlined; and as to "Why an order should not be entered herein continuing the said receivers until the said proceedings relating to the Selden patent have been concluded, or until such other or further time as to the court shall seem advisable." There are nine creditors whose claims have been disallowed by the receivers, and they are given opportunity to show cause why the disallowing should not be approved.

"FUSSING" THE LAMINATED SPRING.

To make the spring serve its purpose better the center bolt is made hollow and filled with a lubricator. Holes are drilled through the wall of center bolt, position registering with face of each leaf, so oil finds its way along surface of leaves by a cut channel. The lower leaf extending full length of the spring is provided with eyes secured on same box as top plate. The effect of bottom plate is to act as a damper to action of other leaves, which, because of perfect lubrication, slide over one another, without separating, no matter what the shock. The end boxes are filled with grease, and the eyes being provided with holes, the shackles bolts are lubricated. The spring treated in this way is said to be stronger, and there are no top plate breaks, and shock absorbers do not have to be used.

TO CLEAN LAMPS.

A half-and-half solution of denatured alcohol and water is excellent for cleaning lamps. Failure to keep burners and glass clean is annoyance that can be easily avoided.

PROSPECTS NOT YET COMPLETED.

Harley-Davidson Motor Co. has a permit to build a \$20,000 factory in Milwaukee, Wis.

Starr Automobile Co. plans a concrete factory at Downing, Wis., to employ 5500 men.

Excavation has begun for a plant for the Auto Parts & Motor Truck Co. at Sandusky, O.

Work of installation of machinery has begun at Jefferson, Wis., for the Jefferson Auto Supply Co.

Work on the Hale wagon and buggy factory, Anniston, Ala, under course of construction, will be completed soon and they have a contract for the delivery of a large order by August 1.

The Ansted Spring and Axle Company, New Castle, Ind., has completed the letting of the contracts for the new spring works plant to take the place of the old one, damaged by fire a month ago.

The Hollingsworth Wheel Company, Hagerstown, Md., incorporated with a capital of \$40,000, will put up a big factory for the manufacture of wheels, hubs, rims, spokes and wheel materials.

A site has been secured for the factory of the Commercial Motor Car Company, of San Antonio, Texas, for the manufacture of motor trucks, and the work of starting the factory will begin at once.

Will and Ben Hostetter, recently of Denver, have succeeded in establishing the new universal motor factory at Newcastle, Ind., and it will be ready for making motors by August or September.

The establishment of a new automobile factory, capitalized at \$100,000, owned and controlled by Waukegan, Ill., men, will be the subject discussed at the meeting of the Waukegan Commercial Association.

Muskogee, Okla., may soon have a wagon factory, which will start out with 50 men on the payroll. A Texas man wants to locate such a factory there and has taken the matter up with the commercial club.

The New-South Automobile Company is applying for a charter at Augusta, Ga. There has been delay from the fact that names adopted had already been employed by companies in the field. The moving spirit is L. J. Williams.

The Greenville, Pa., Board of Trade celebrated the securing of a large industry from Jamestown, N. Y. It will be known as the Greenville Metal Construction Company, with a capitalization of \$600,000. Automobile parts will be manufactured.

Officials of the Standard Automobile Company, of Illinois, have chosen Elgin, Ill., as the most desirable site for a big motor car factory, and opened negotiations with interested Elgin men who took the matter up with the Elgin Commercial Club.

Oklahoma City, Okla., may be selected as the site for a branch factory of the Elkhart Motor Car Company, of Elkhart, Ind., manufacturers of the Sterling automobile, according to the statement of W. W. Sterling, of Elkhart, president of the company.

French & Kecht, Davenport, Ia., started work on the superstructure of their new foundry for the big wagon works which they are erecting at Third and LeClaire streets. The new foundry will be built of reinforced concrete and will be two stories high.

B. C. Rees, secretary of the Commercial Club, La Porte, Ind., is in receipt of a letter from a Chicago manufacturing concern whose output is automobile delivery wagons and trucks, asking for information as to a possible site and facilities for a proposed branch factory.

South Bend, Ind., is to be the home of an automobile accessories factory. The Clover Leaf Machine Company, manufacturer of concrete block machinery and the Yuster Axle & Transmission Company, were merged and under the name of the Clover Leaf Axle Company, the proprietors will embark in the manufacture of automobile axles.

Within the next two months it is expected that actual work of construction will have been started on the plant of the Northwestern Wheel & Wagon Company, recently incorporated at

Bellingham, Wash. The site of the factory has already been decided upon and preliminary work of excavating for the foundation will be begun at an early date.

PERSONAL.

D. R. Porter has become sales manager of the Lansing (Mich.) Auto Wheel Co.

Edward Ring, with the Babcock Carriage Co., of Watertown, N. Y., married Miss Hawley recently.

E. J. Peer, late secretary and treasurer of the Reo Motor Car Co., has resigned. He is succeeded by J. E. Roe.

John McGuire, formerly connected with the B. F. Goodrich Co., has been elected president of the Republic Rubber Co.

A. L. Moore has been advanced to man in control of the Moline Wagon Co. He used to be the superintendent.

Dr. John Hayward, the bookkeeper of the Stamford Carriage Co., has absconded. Shortage \$15,000 so far.

W. J. Lasher, general sales manager of the H. J. Koehler Co., the New York City agents for Hupp and Everett, has resigned.

The daughter of H. J. Romney, of the Consolidated Wagon Co., Salt Lake City, Utah, was married in June to G. F. Coulam.

Snyder & Hillaker, of Port Chester, N. Y., the wagon builders, have taken up an adjustable axle nut intended to do away with wear and lost motion.

C. F. Ferguson, treasurer of Turnbull Wagon Co., Defiance, Ohio, has been visiting Victoria, B. C., to look up possibilities of establishing a carriage and wagon plant.

About seventy-five union smiths, painters, etc., walked out from the factories of A. C. Miller & Co. and J. M. Kartwisch, Atlanta, Ga. They wanted a 9-hour day and were denied.

By means of a deal W. C. Heitzman secured control of \$20,000 worth of stock of the Union City (Ind.) Carriage Co. and becomes manager, vice E. C. Tritt, who retires on account of health.

The new officers of the Moline Wagon Co are: President, William Butterworth; first vice-president, W. L. Velie; second vice-president and general manager, A. L. Moore; secretary, Schiller Hosford; treasurer, B. F. Peck.

T. W. Goodridge, who in his past connections with the Electric Vehicle Co., the Studebaker Automobile Co., and the Maxim-Goodrich Co., became prominently identified with the trade, has joined the forces of the Matheson Automobile Co.

Lloyd E. Latta, who became connected with the Maxwell-Briscoe Motor Co. in the capacity of assistant secretary, has been elected secretary of the company. For the past four years he has been assistant manager of the Racine (Wis.) Mfg. Co.

G. W. Stephens and F. S. Croyley have formed a company to be territory distributors of the Cole 30, and will be temporarily located in the Standard Automobile Company in Chicago. In the near future they will remove to much more commodious quarters.

B. J. MacMullen, who for three years has been connected with the New York branch of the White Co., of Cleveland, O., has gone with the Overland Selling Co. He will be under George W. Bennett, the general sales manager of the Willys-Overland Co., of Toledo, Ohio.

Charles E. J. Lang, secretary and treasurer of the Rauch & Lang Carriage Co., Cleveland Ohio, left in June for an extended tour around the world. Mr. Lang will make a careful study of the electric vehicle situation in all of the cities that are included in his itinerary. He will be accompanied by Mrs. Lang.

W. J. Evans, of Chicago, secretary of the National Association of Agricultural and Vehicle Manufacturers and auxiliary organizations, accompanied by Ralph Zint, of Pittsburg, Pa.; T. S. Stallsmith, Cleveland, Ohio; Richard Gradwell and J. A. Craig, a committee appointed to make preliminary arrangements for the convention of the vehicle manufacturers in St. Louis, November 1 to 3, with A. T. Stevens of St. Louis. Their work was to make hotel arrangements for the 500 delegates. Headquarters will be at the Southern Hotel.

Trade News From Near and Far

NEW FIRMS AND INCORPORATIONS.

Fred Bowers, Fultonville, N. Y., has opened a wagon shop. Newark Wagon Co., Newark, N. J., has been incorporated; capital, \$100,000.

Scofield Buggy Co., Ovid, Mich., has been organized to manufacture buggies.

Hale Buggy Co., Anniston, Ala., has been incorporated with a capital of \$25,000.

The Hupp-Yates Electric Car Co. is the fourth of a group of Hupp companies that filed articles and will erect a plant in Detroit.

Jamestown Wheel and Manufacturing Co., Ellicott, N. Y., has been incorporated by G. M. Thompson and others; capital, \$25,000.

Pierce & Harvey Buggy Co., Miami, Okla., capital \$25,000; has been incorporated by M. L. Pierce, C. M. Harvey and Bessie Harvey.

The Smith Motor Company, Terre Haute, Ind., to manufacture auto parts, capital, \$25,000; incorporators, W. B. Smith, E. B. Smith.

Caffall Carriage Co., Beaumont, Texas, incorporated; capital, \$20,000. Incorporators: H. J. Halliday, D. M. Caffall, J. O. Ogden and C. A. Lord.

Clark Motor Co., Buffalo, N. Y., automobiles, engines, etc., has been incorporated by Stanley B. Delon and John W. Van Allen, with a capital of \$50,000.

Shaw-Merillat Co., Chicago, Ill., motor vehicles, etc., has been incorporated with a capital of \$10,000 by H. I. Shaw, E. R. Bliss, Jr., and Lloyd Merrillat.

Knox Auto and Wagon Manufacturing Company, Los Angeles, Cal., capital \$50,000; F. A. Knox, C. M. Jones, W. Slayden, J. F. Jones, S. W. Stewart, directors.

Sweeney Automobile Co., Camden, N. J., to manufacture automobiles, etc., capital \$10,000; has been incorporated by F. R. Hansell, John A. McPeak and others.

Bushey Demountable Rim Co., New York City, to manufacture and deal in automobiles, parts, etc., has been incorporated by G. B. Lambert and others; capital \$20,000.

Junkers-Burdick Co., Chicago, Ill., has been incorporated with a capital of \$25,000 for the manufacture of automobiles and accessories by O. Junkers and W. Burdick.

The New Wapakoneta Wheel Company, Wapakoneta, Ohio.; L. N. Blume, Charles Kahn, J. W. McMurray, John Taesch, Louis Piel and C. T. Koeter; capital \$75,000.

Rayfield Motor Car Co., Springfield, Ill., manufacturers of automobiles and accessories, has been incorporated with a capital of \$150,000 by J. F. Miller and E. E. Staley.

The Falcon Motor Car Manufacturing Co., Camden, N. J., to manufacture automobiles, motor cars, etc., capital \$125,000, has been incorporated by Frank A. Kuntz and others.

The Thomas B. Jeffrey Co., manufacturers of automobiles, Kenosha, Wis., has been incorporated with a capital of \$3,000,000 by K. E. Jeffrey, C. T. Jeffrey and H. W. Jeffrey.

Jewett-Gamage Co., Worcester, Mass., to manufacture and sell vehicles of all kinds; capital, \$10,000. Incorporators: President, George H. Jewett; treasurer, Wilbur S. Gamage.

Holton-Meyers Auto & Truck ompany, capital \$10,000, to manufacture and deal in automobiles and supplies, has been incorporated by Richard Bolton, 81 Vliet St., Cohoes, N. Y.

John G. Jager Co., New York City; manufacture and repair vehicles of all kinds; capital, \$1,100. Incorporators: Chas. W. Rivers and Edward Jager, 358 W. 43d St., New York City.

The C. S. Morris, Co., Atlanta, Ga., has been incorporated with a capital of \$2,000 by C. S. Morris, W. J. Dabney and C. E.

Bothwell to manufacture and sell machinery and vehicles.

United States Wheel Company, New York, N. Y., capital \$1,000,000, has been incorporated by Joseph Tooker, S. P. McConnell and others to manufacture and sell wheels of all kinds.

The Marion (Ohio) Dump Wagon Co., manufacturers of wagons, etc., has been incorporated by H. S. Long, Jay Smiley, G. B. Christian, C. C. Fisher and W. T. Jones. Capital, \$10,000.

Balance Gear Light Vehicle Co., New York, to manufacture vehicles, capital \$30,000; has been incorporated by Walter E. McDonnell, New York City; Thomas Spalding, Long Island City.

Farrington Automobile Company, Chicago, Ill.; capital, \$10,000; to manufacture and deal in automobiles and accessories. Incorporators: Joseph T. Delfosse, W. H. Farrington, Samuel F. Scott.

Lorraine Motor Co., Camden, N. J., to manufacture automobiles, motor cycles, etc., has been incorporated with a capital of \$60,000. Incorporators: F. R. Hansell, John A. MacPeak and others.

The United States Auto Bumper Company, Chicago; capital, \$1,500; manufacturing, mercantile and construction business; incorporators, Allen L. McGregor, J. Scott Matthews, William J. Matthews.

The Howse Commercial Car Co., Detroit, Mich., a commercial power truck manufacturing concern, has been incorporated with a capital of \$60,000 by August J. Stieber, Charles F. Howse and E. P. Newton.

The John Deere Plow Co., of Portland, Ore., has been incorporated in Illinois; capital \$250,000, to deal in implements, vehicles, autos, etc. Incorporators: William Butterworth, Schiller Hosford and George W. Mixer.

The Hale Motor & Machine Co., Detroit, Mich., capital stock \$125,000, has been incorporated by S. E. Hale, Charles Ritter, Jay C. Hudson, R. J. Brennan, J. E. Dubois, Joseph W. Humphrey and Henry C. Walters.

Chicago Jack and Supply Company, Chicago, Ill.; capital, \$14,000; manufacture and deal in automobiles and motor vehicles, etc., general merchandise business; incorporators, Earle L. Robinson, A. E. V. Wright, John M. Timmons.

C. & H. Manufacturing Co., Jersey City, N. J., general manufacturing business, vehicles; capital, \$100,000. Incorporators, Herman W. Hoops, Richard W. Gallagher, both of New York City; Pierre Bachman, Orange, N. J.

Rogers Nuika Wheel Co., Kittery, Maine, incorporated to manufacture vehicles. Capital \$2,500,000. Nothing paid in. Incorporators: Horace Mitchell, Kittery, president; C. E. Smothers, Portsmouth, treasurer; M. G. Mitchell, Benjamin F. Bunker and Albert Peavey, all of Kittery.

The Selma (Ala.) Spoke Factory has incorporated; capital stock, \$10,000. It will make spokes and hardwood parts of automobiles. Incorporators: H. E. Masters, president; John F. Breece, vice-president, and A. L. Brown, secretary. The company's buildings are fast nearing completion and it is expected the plant will soon be put in operation. The concern will employ about 100 men.

The Gaylord Motor Car Company, Gaylord, Mich., has been incorporated with a capital of \$100,000, one-half of which is paid in. The automobile which they will make is a general utility car, designed by Guy L. Hamilton, of Detroit, who will act as general manager of the new company. It is announced that the factory will be in readiness to run within 90 days. The newly elected officers are: A. B. C. Comstock, president; Frank A. Kramer, vice-president; John L. Pelton, secretary; J. Lee Morford, treasurer.

BUSINESS CHANGES.

Fred Decker, Scranton, Pa., succeeds E. R. James in the wagon business.

A. W. Cornwall, Gridley, Ill., dealer in vehicles and implements, has been succeeded by Baughman & Ehresman.

The Van Da Grift Auto Car Company filed amended articles of incorporation, changing its name to the Van Da Grift Motor Car Company, of Louisville, Ky.

The Morrison Wagon Company filed a certificate with the Secretary of State, showing that its principal office and place of business had been removed from Troy to Albany.

The Ohio Steel Wagon Co., of Wapakoneta, Ohio, manufacturers of all steel wagons, has sold its factory to Breese Bros., of Cincinnati, and William Thompson, of Kalamazoo, Mich.

John Gregg, Phoenix, Ariz., carriage, paint and repair shop, has sold his property to a Mr. Peters. Gregg will open another shop in another part of town to equip and run as a carriage paint shop.

The partnership between William Gray and Lambert Hollander, under the name of Gray & Davis, at Amesbury, Mass, has been dissolved. Mr. Hollander feels that he has earned a rest from business cares and troubles and on July 1 sailed for Europe.

The Champion Company, a Boston concern engaged in the manufacture of spark plugs for automobiles, will remove to Toledo. The machinery for the company is expected to arrive in a week or ten days. The concern will supply spark plugs for the Willys-Overland Manufacturing Company.

The Seitz Automobile & Transmission Co., now located in Detroit, Mich., has definitely decided to remove to Wyandotte. The site offered by that city has been accepted, citizens have subscribed \$30,000 worth of stock and plans for three large factory buildings are being prepared. The Seitz Co. was organized two years ago and since then has been engaged largely in experimental work. A high degree of perfection has been attained and it is now planned to undertake the manufacture of commercial trucks, ranging from one-half a ton to three tons, on an extensive scale. Arrangements already have been completed to establish a temporary branch in Windsor and a permanent Canadian branch will be established later.

IMPROVEMENTS—EXTENSIONS.

Marquette Motor Co., Saginaw, Mich., has increased its capital from \$300,000 to \$500,000.

The Kelsey Wheel Co., Detroit, Mich., has increased its capital from \$300,000 to \$500,000.

The Oakland Motor Car Co., Detroit, Mich., has increased its capital from \$200,000 to \$800,000.

The Detroit Carriage Co., Hamtramck, Mich., has increased its capital from \$100,000 to \$150,000.

Columbia Carriage Company, Hamilton, Ohio, increased its capital from \$275,000 to \$350,000.

The Glidden Varnish Co., of Ohio, has been given extended powers under the Ontario Companies Act.

A. F. Sargent & Co., Geneseo, Ill., are now nicely established in the new building erected since the late fire.

The Watson Wagon Company, of Canastota, N. Y., has increased its capital stock from \$400,000 to \$600,000.

The Baynes Carriage Co., Ltd., Toronto, Can., has been authorized to increase its capital from \$250,000 to \$375,000.

Improvements and additions on a large scale are to be made to the plant of the Cadillac Motor Car Company at Detroit.

The Mack Motor Car Works, Allentown, Pa., will erect a machine shop in addition to its plant. The building will be of brick, one story.

A five-story plant is to be erected by the Harley-Davidson Motor Company, Milwaukee, Wis., at Thirty-eighth and Chestnut streets, to cost \$20,000.

The Kentucky Wagon Manufacturing Company, Louisville, Ky., filed amended articles of incorporation which state that

the capital stock shall be \$1,750,000, and that the greatest amount of indebtedness that may be incurred at any time is \$750,000. W. C. Nones is president.

The Covert Motor Vehicle Works, Lockport, N. Y., manufacturers of parts of automobiles, will soon begin the work of doubling the size of its plant.

Material is being placed on the ground for the new factory building to be erected by the Oxford (N. C.) Buggy Company. This addition will be three stories.

The Interstate Automobile Company, Muncie, Ind., will enlarge its present plant. A new building will adjoin the present factory structure and will be similar.

A \$500,000 contract for the largest single building for the exclusive manufacture of automobile tires ever built, was let by the Firestone Tire & Rubber Company, at Akron, Ohio.

The Superior Motor Vehicle Company, Buffalo, N. Y., has obtained a permit for its new one and two story brick factory to be erected at 1686 Elmwood avenue, near Grote street, at a cost of \$81,000.

The Anderson Carriage Company, Detroit, Mich., is building another addition to its plant, which already contains over seven acres of floor space. The new building will be of reinforced concrete, three stories high.

Mr. W. A. Swiger, Grafton, Va., has recently completed plans for enlarging his shop and contracted for the wood and iron working machinery necessary in the manufacturing of a general line of carriages and wagons.

The new home of the Grabowsky Power Wagon Co., on Mt. Elliott near the Michigan Central, Detroit, Mich., will be of reinforced concrete and will cost in the neighborhood of \$50,000. The main building will be 62x290 feet.

William Wichers & Sons, Zeeland, Mich., wagon makers and dealers, are building an addition to their plant. It will be used as a storage place for lumber and shingles, will be two stories high and have a floor space of 14,000 feet.

The Totten Auto Company, Rock Island, Ill., is planning to make an extensive addition to its Third avenue plant in the shape of a two-story annex with dimensions of 80x40 feet, and which will be equipped for any kind of auto work.

At a meeting of the board of directors of the General Motors Co., held in New York, plans for the big additions to the plant of the Reliance Motor Truck Co. were accepted, which means that building operations are to begin at once at Owosso, Mich.

The Streator Motor Car Company, of Streator, Ill., commenced the erection of two machine shops, each 75 by 400 feet. These buildings are to be of the latest mill construction, and machinery is already on the ground for equipping them throughout.

Hugo Scherer and F. E. Wadsworth, president and secretary of the Michigan Steel Boat Works, Detroit, Mich., have purchased the property at the northwest corner of Jefferson and Bellevue avenues, diagonally opposite the boat works, and will erect immediately a three story automobile plant.

The American Tube and Stamping Co., of Bridgeport, Conn., which manufactures rims and other components for motor cars, has purchased an additional factory and ten acres of land on Hancock avenue, owned by the Bridgeport Copper Co. The factory has a floor space of 125,000 square feet.

Plans and specifications are now being prepared for a three-story wagon factory for Frank Eller, Houston, Texas. The new building will be so constructed that three more stories may be added when the necessity arises. The building will be of mill or slow burning construction, and when completed, will represent an approximate outlay of \$40,000.

The Schacht Mfg. Co., of Cincinnati, O., making Schacht motor buggies and "3-in-1" general purpose cars, has decided upon an increase of capital stock from \$100,000 to \$500,000 and has laid plans for a new factory in Cincinnati, instead of removing elsewhere as at one time contemplated. The new building will be on Spring Grove avenue, and will be 600x60 feet, three stories high. It will be of brick, concrete and steel, with the side walls consisting largely of glass, in order to provide a maximum of

light. The cost of the improvement is placed at \$90,000, and arrangements have been made for private railroad switches and other special shipping facilities.

The increase in the capital stock of the Cartcar Company, Pontiac, Mich., from \$350,000 to \$650,000 is to take care of the expansion the company will make as soon as architects' plans are completed, on which they are now at work. The plans call for a one story machine shop and a four-story warehouse. Thirty-six thousand feet of additional floor space will be given by the new buildings. New offices will also be provided.

The James Cunningham, Son & Company, Rochester, N. Y., carriage manufacturers, is to build a large addition to its plant which will be used exclusively as an automobile plant. The new building will be erected just northwest from its present factory, and will be four stories high, having a frontage of 135 feet, and a depth of 127 feet. The building will be of brick, and will be so designed that every process of manufacture can be carried on with the greatest convenience.

The Goodyear Tire and Rubber Co. has almost completed a good sized factory at Bowmanville, Canada, which is partly in operation and when completed will employ 100 men. The Goodyear company, which has an extensive trade over the border, has been induced to take this step as a means of offsetting the import duties charged in Canada. The new plant for the present will be devoted to the manufacture of tires. The business of the Canadian branch will be conducted under a Dominion charter, with \$250,000 capital, the incorporators being D. M. Simpson, W. F. Stearns, Norris Wilson, D. C. Betts, J. S. Moorcraft, A. W. McMillan, and J. H. McMurtry, the address of all of whom is given as Bowmanville.

BUSINESS TROUBLES.

The Corydon (Ind.) Wagon Co. has been sued for \$10,000 for personal injuries to an employe named Abbott.

James Wallingford, a carriage manufacturer of Ottawa, Ill., filed a petition in bankruptcy. He listed liabilities to the amount of \$2,663.50 and assets of only \$50.

Sheriff P. F. Connor sold the property of the Scranton Axle Works for taxes and costs. The property was bought by H. C. Reynolds, attorney for some of the officers of the company.

W. T. Durbin, receiver for the Elwood Buggy and Implement Company, Anderson, Ind., has been ordered by Judge Austil to sell the property at auction. The failure of the buggy company followed in the wake of the receivership proceeding against the Anderson Carriage Company. The stock of the Elwood concern is appraised at about \$10,000.

Perry Gossett of Covington, Ky., has filed suit against the Otto Armleder Carriage Manufacturing Company. On May 15, 1909, plaintiff, while in the employ of John Kennet & Co., painters, of Covington, who had a certain contract to paint a portion of the defendant company's plant, fell down an elevator shaft and sustained bodily injuries.

William G. Phelps, secretary of the old Binghamton (N. Y.) Wagon Company, owner and operator of a vehicle factory at the plant now occupied by the Stickney-Brandt Company, has called a special meeting of the stockholders of the company for the purpose of beginning a voluntary dissolution of the company under the general incorporation law.

The trustees appointed in the case of Joseph Frank Hastings vs. the Delmar Buggy Hardware Co., of Delmar, Del, made their report. They recommend a decree in favor of the complainant, with the costs taxed to the respondent. The case was one of the most novel ones brought in the Court of Chancery for some time. On April 27 counsel for the complainant filed a bill in the Court of Chancery and secured a rule against the company, to show cause why a preliminary injunction should not be issued. The bill set out that on January 28 the complainant owned one share of the capital stock of the Delmar Buggy Hardware Co., valued at \$100, and five shares of the First National Bank of Delmar, valued at \$100 a share. Previous to that time he was

secretary and treasurer of the company. On the above date, the bill stated, Levin Hastings, president of the company; William H. Hayman and James W. Freeny, directors, called the complainant into a room and informed him that they had been appointed a committee by the board of directors to notify him that he was short in his accounts and threatened to prosecute on a criminal charge unless he made good the alleged shortage which they said was an unascertained amount. The trustees reported that there was no shortage in the cash or accounts of the company except an item of \$60, admitted by all parties, and which was repaid by Mr. Hastings. Continuing, the referees report that they found the complainant is entitled to a decree requiring the company to return to Mr. Hastings \$809.50 from the sale of the bank stock and the sum of \$50 for the one share of stock in the company.

FIRES.

Adams Wheel Mfg. Co., Cleveland, Ohio, suffered total loss by fire.

Newhall & Walker, Everett, Mass., suffered fire loss. Damage not reported.

F. J. Palmer, Skowhegan, Maine, carriage shop, suffered loss by fire. Insured.

Bundy & Woods, St. Johnsbury, Vt., lost about 50 vehicles, estimated at \$1,750, by fire.

McGuire Bros. & Small, Houston, Miss., spoke factory, was damaged by fire. Loss, \$4,000.

D. M. Sechler Carriage Company's storehouse at Omaha, Neb., was partially damaged by fire. Loss, \$2,000, estimated.

The buggy bow works of the Ames Bending Company, Celina, Ohio, was destroyed by fire. The loss is estimated at \$35,000.

A SAIL WAGON.

The new sail vehicle of a German inventor, described by Consul T. H. Norton, of Chemnitz, promises good results for speed contests and pleasure purposes on smooth roads and sandy stretches, like sea beaches. Unlike early clumsy sail wagons, this vehicle is very light. It has a light framework supporting a saddle and the mast, and resting on four wheels, one on either side and larger ones in front and behind, the rear wheel and the right side wheel being rigidly connected, as are also the front wheel and left side wheel. The two connecting bars are joined by an axle with hinged attachment at each end. Sitting in the saddle with his feet on the cross axle, the rider can guide the wheels by suitable pressure and has his hands free for adjusting the sail or using a brake.

A GREAT CENTER.

In carriage and buggy production St. Louis is now a great center. More than a dozen concerns are operating twenty plants which make the whole vehicle or parts. The output of these establishments was materially increased last year and conservative estimates place the number made at 85,000 or more, and add to this 15,000 vehicles of many kinds of outside make jobbed by representatives in St. Louis. In conjunction with this industry are many establishments which turn out farm and stake wagons and heavy or a large type of delivery wagon. The wagon building industry has made large strides in recent years and the annual output is more than 15,000. Several thousand more are jobbed through St. Louis houses.

DEDICATED BY FIRE DEPARTMENT.

The fire department of the Bay State Metal Wheel Co., East Templeton, Mass., which is to have charge of dedicating the new shop now nearing completion, have fixed upon July 15 as the date of the event. Preparations are being made for a grand event.

VEHICLES IN NASHVILLE.

The manufacture of vehicles and agricultural implements in Nashville has increased at a rate hardly to be appreciated by persons not directly interested. To-day Nashville is leader in the South.

Only about a dozen years ago a little wholesale show room was started in the city by the Deeds & Hirsig Manufacturing Company. In a very few years an entire building was necessary. The business of that corporation has grown until three large buildings are occupied.

To-day Nashville has five immense jobbing houses engaged in the implement and vehicle trade and all of them are doing a large business, with each year showing an increase over the preceding one. The salesmen of these Nashville houses invade every state in the South, extending and multiplying their transactions and even invade the business field which, in years gone by, was supposed to belong entirely to Northern concerns.

The business of constructing wagons and buggies has grown within a few years. Ten factories are turning out product which finds its way to the markets of the South. The sales of the wholesalers and jobbers last year amounted to \$1,200,000.

1910 FAIR DATES.

| | |
|-------------------------------------------------|-----------------|
| Alabama (state), Birmingham | Oct. 6-15 |
| Arkansas (state), Hot Springs | Oct. 10-15 |
| California (state), Sacramento | Sept. 3-10 |
| Colorado (state), Pueblo | Sept. 19-24 |
| Colorado (interstate), Denver | Sept. 3-17 |
| Connecticut (Danbury), Danbury | Oct. 3-8 |
| Idaho (Lewiston-Clarkstone), Lewiston | Oct. 10-15 |
| Idaho (Inter-mountain), Boise | Oct. 10-15 |
| Illinois (State), Springfield | Sept. 30-Oct. 8 |
| Indiana (state), Indianapolis | Sept. 12-16 |
| Iowa (state), Des Moines | Aug. 25-Sept. 2 |
| Iowa (interstate), Sioux City | Sept. 19-24 |
| Kansas (state), Hutchinson | Sept. 10-17 |
| Kansas (state exposition), Topeka | Sept. 10-17 |
| Kentucky (state), Louisville | Sept. 12-17 |
| Kentucky (Blue Grass), Lexington | Aug. 8-13 |
| Louisiana (state), Shreveport | Nov. 2-11 |
| Maine (state), Lewiston | Sept. 5-8 |
| Maine (eastern), Bangor | Aug. 23-26 |
| Maine (central), Waterville | Aug. 30-Sept. 2 |
| Maryland (state), Timonium | Sept. 6-10 |
| Maryland (Hagerstown), Hagerstown | Oct. 11-14 |
| Massachusetts (New England), Worcester | Sept. 5-8 |
| Michigan (state), Detroit | Sept. 19-24 |
| Michigan (West Michigan), Grand Rapids | Sept. 12-16 |
| Minnesota (state), Hamline | Sept. 5-10 |
| Missouri (state), Sedalia | Oct. 1-7 |
| Mississippi (state), Jackson | Oct. 25-Nov. 3 |
| Montana (state), Helena | Sept. 25-Oct. 1 |
| Nebraska (state), Lincoln | Sept. 5-9 |
| New Jersey (interstate), Trenton | Sept. 26-30 |
| New York (state), Syracuse | Sept. 12-17 |
| North Carolina (state), Raleigh | Oct. 17-22 |
| North Dakota (state), Fargo | July 25-30 |
| Ohio (state), Columbus | Sept. 5-9 |
| Oklahoma (state), Oklahoma City | Sept. 27-Oct. 9 |
| Oregon (state), Salem | Sept. 12-17 |
| Pennsylvania (Granger's picnic) Williams' Grove | Aug. 29-Sept. 3 |
| Pennsylvania, Bethlehem | Sept. 6-9 |
| Pennsylvania, Allentown | Sept. 20-23 |
| South Carolina (state), Columbia | Oct. 31-Nov. 5 |
| South Dakota (state), Huron | Sept. 12-16 |
| Tennessee (state), Nashville | Sept. 19-24 |
| Tennessee (Tri-State), Memphis | Sept. 27-Oct. 4 |
| Texas (state), Dallas | Oct. 15-30 |
| Utah (state), Salt Lake City | Oct. 3-8 |
| Vermont (state), White River Junction | Sept. 20-30 |
| Virginia (state), Richmond | Oct. 3-8 |
| Washington (state), North Yakima | Sept. 26-Oct. 1 |
| Washington (interstate), Spokane | Oct. 3-9 |
| West Virginia (state), Wheeling | Sept. 12-16 |
| Wisconsin (state), Milwaukee | Sept. 12-16 |
| Wyoming (state), Douglas | Sept. 27-30 |

Leading Canadian Fairs of 1910.

| | |
|---------------------------------|-------------------|
| Canadian National, Toronto | Aug. 27-Sept. 12. |
| Central Canada, Ottawa | Sept. 9-17 |
| Alberta Provincial, Calgary | June 30-July 7 |
| Vancouver Exhibition, Vancouver | Aug. 15-20 |

OBITUARY

Addison C. Gowdy, an old resident of Saco, Maine, died June 1, after a long illness, aged 79. He is survived by a widow. In 1862 he moved to Saco, where he entered the employ of Owen Chadbourne, at that time proprietor of a large carriage manufactory.

At the end of half dozen years he went to work for B. Frank Hanscom, where he was employed for several years. He then decided to engage in business for himself and opened a factory at the corner of Pleasant and Elm streets, where he manufactured vehicles. Some years ago he suffered a sunstroke, which affected his eyes and later he was obliged to dispose of his business.

Alexander Montgomery, one of the oldest residents of Toronto, Canada, died May 24. He was born in 1835, and about 1860 established a carriage and wagon business at the corner of Queen and Givens streets and has resided there ever since. He leaves a widow, two sons, two daughters and three brothers.

W. H. Kennedy, of the Nashua (N. H.) Carriage Co., was instantly killed as the result of an automobile accident June 9. He is survived by a widow and three children.

Samuel G. Foos died at his home in Newark, Ohio. His death was due to a stroke of paralysis. Mr. Foos was engaged in the carriage manufacturing business with his brother, Nelson. He was born in Columbus, Oct. 14, 1840.

W. P. Bettendorf, president of the Bettendorf Axle Company, Geneseo, Ill., died at his home in Bettendorf, a suburb of Geneseo, while on the operating table and just at the conclusion of an operation that had been performed on him for an obstruction of the lower bowel. He was born in Mendota, Ill., July 1, 1857.

John Napier, 76 years old, a retired carriage manufacturer, who once conducted his business on the site of the present Pittsburg postoffice, died at his home at Bellevue, Pa. About 25 years ago he retired from business. Mr. Napier is survived by his wife.

Henry John Frank, treasurer of the firm of Donigan & Nielson, carriage and wagon builders, and a resident of South Brooklyn for forty years, died of Bright's disease at his home. He was born in New York on May 22, 1866.

WAGONS BECOME BENCHES.

Dr. Carver, the showman, gave an order to Mitchell and Lewis Co., Racine, Wis., for forty-five handsome wagons, 12 feet by 7 feet and 9 feet in height. These wagons will serve a double purpose for the Carver show. Upon entering a town they will be paraded around for advertising purposes, and will then be employed as grand stand seats at the circus. The wagons, which will be placed in a circle on the show grounds, will have Brussels carpeted seats for patrons. When placed in position and the ends let down they will form almost continuous seats around the arena, enabling people to walk around as on the regulation grand stand. The 45 wagons will comfortably seat over 8,000 people, and will also protect people from sunshine or rain.

NEW LINES ADDED.

The Seneca Rubber Company, Buffalo, N. Y., which has in the past been successfully handling G. & J. tires, has just completed arrangements to take on additional rubber products. Arrangements have been finished whereby they will be the agents for the Manhattan Rubber Mfg. Co., of New York, in Buffalo and surrounding territory. This will include all mechanical rubber goods such as belting, packing, hose, matting, etc.

It has also completed arrangements for handling the solid truck and carriage tire, known as the Kelly-Springfield, manufactured by the Consolidated Tire Company, of New York and Akron, Ohio.

Recently Granted Carriage Patents

Separator for Elliptic Springs. William Gunn Price, New Castle, Pa. No. 960,396. Patented June 7, 1910.

The combination of two or more elliptic springs, means for

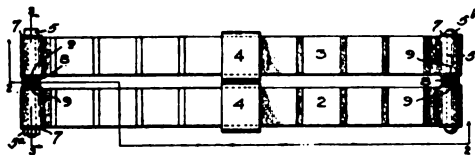

connecting them, means for separating, and means for automatically taking up the wear between.

Pneumatic Vehicle Gear. Louis J. Perkins, Lewiston, Idaho. No. 960,579. Patented June 7, 1910.

A device comprising connected relatively movable members, one of the members being axle supported and the other being adapted for the support of a vehicle body, the first mentioned

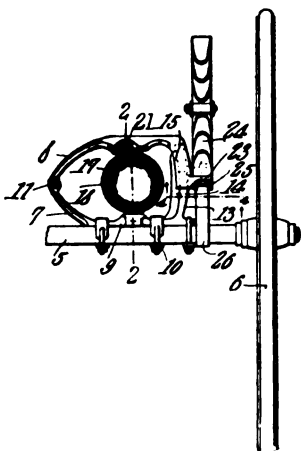

member being formed with an upstanding arcuate member and the second being formed with a downwardly projecting arcuate member receiving the upstanding member, whereby to relatively guide the sections when moving, and a pneumatic cushion interposed between members.

Hood for Motor or Other Vehicles. James Sime Cree, Glasgow, Scotland. No. 960,832. Patented June 7, 1910.

A hood for motor or other vehicles, comprising front and rear series of adjacently pivoted hoops relatively so positioned upon the vehicle that the front hoop of the rear series and the rear

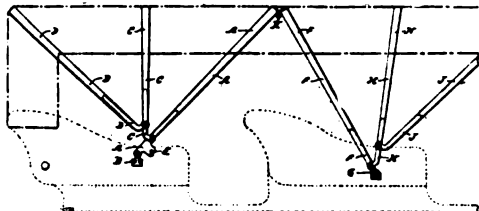

hoop of the front series abut at their upper parts when the hood is open and pivotal connection between the abutting parts, the supplemental hoops in each series being carried by abutting hoops respectively.

Running Gear Construction. Emil Gruenfeldt, Cleveland, Ohio, assignor to The Baker Motor Vehicle Company, Cleveland, O. No. 960,897. Patented June 7, 1910.

A device in combination with a self propelled vehicle comprising a frame, a front axle, a rear live axle, and a motor driven shaft for driving the live axle sections of rear axle and journaled in the housing of rear axle, of full elliptic springs, one at either side of the frame, interposed between the live axle housing and the frame, each of the springs having its lower half rigidly se-

cured to the live axle housing, means for pivotally connecting the upper half of each spring to the frame, and links, each piv-

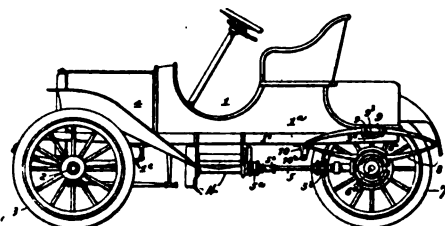

otally connected at its upper end to the front end of the adjacent spring, and at its lower end having a pivotal connection with frame.

Vehicle Top. Herbert C. Martell, Flint, Mich. No. 960,979. Patented June 14, 1910.

A vehicle top, comprising a center bow pivoted to the vehicle, a rear bow pivoted to the arms of the center bow near their connection with the vehicle, folding braces connecting the center bow with the vehicle, a front bow, brackets on the center bow near the junction of the arms with the body portion, a lever piv-

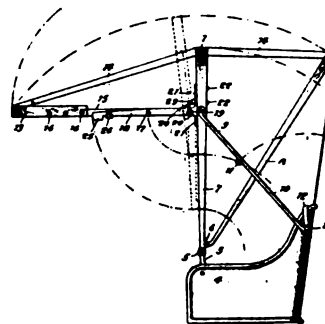

oted to each bracket and having at its free end a lateral lug or finger piece, one of the arms of the front bow being pivoted to each lever intermediate the ends of the lever, and a catch on the arm between the finger piece and the pivotal connection of the arm with the lever, the end of the lever resting upon the catch when the top is in upright position, and retaining the lever in alignment with the arm of the bow, the lever having a lateral lug at the end connected with the bracket, and the brackets having an upward extension, and a setscrew threaded through the lug and engaging the extension for limiting the upward movement of the lever.

Differential Axle. Norman B. Seabrook, Los Angeles, Cal. No. 961,376. Patented June 14, 1910.

A differential axle comprising two axle members, a retaining ring on one axle member, a sleeve with an internally enlarged

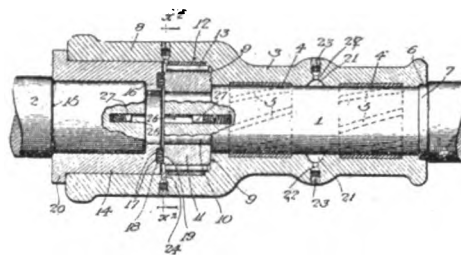

end to receive the retaining ring and form a shoulder to abut ring, the end of the sleeve being secured by frictional engagement on the other axle, the other end of sleeve having a journal fit on the first mentioned axle.

Spring Support for Wagon Shafts. Paul W. Zeller, Buffalo, N. Y. No. 961,708. Patented June 14, 1910.

A supporting device for holding the shafts of a wagon in an

elevated position comprising a tubular roller, a spring fulcrumed on tubular roller and extending in opposite directions from its

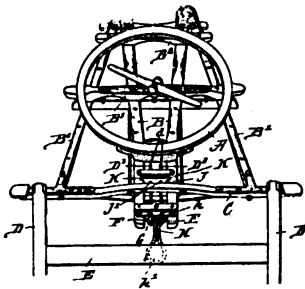

fulcrum point, one end of spring being in contact with the under side of a cross-bar secured to shafts, a yoke bearing against the underside of the hounds of the wagon, and having the opposite end of supporting device adjustably secured thereto, and a hanger supported on hounds and sustaining the yoke and supporting device.

Vehicle Top Bow Holder. Sherman T. Allen, Detroit, Mich. No. 962,487. Patented June 28, 1910.

In combination with the bows of a vehicle top, laterally projecting members fixed thereto, a receiving bracket into receiving

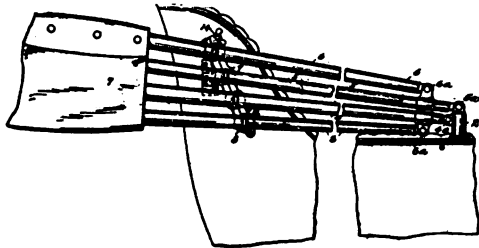

portions of which each of the members is adapted to reach when bows are lowered, and a holding member adapted to be locked in position over bracket and members.

Wheel Construction. Chester A. Frick, Defiance, Ohio. No. 962,631. Patented June 28, 1910.

A wheel, the combination with the abutting hub ends of spokes having registering sockets therein, of dowel-pins disposed within

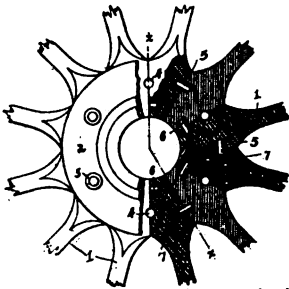

the sockets to lock the spokes against relative movements, the pins being arranged in staggered relation and tangentially disposed relatively to circles concentric to the wheel axis.

Wheel Construction. Orlando A. Frick, Defiance, Ohio, assignor to The Turnbull Wagon Company, Defiance, Ohio. No. 962,207. Patented June 21, 1910.

A wheel the combination with the inner hub end portions of the spokes having flat lateral abutting surfaces and sockets pro-

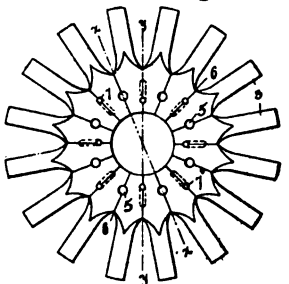

vided within the seams formed by such surfaces, of keys inserted within sockets and disposed at an incline relative to the wheel axis, alternate keys being oppositely inclined.

RECENTLY GRANTED PATENTS OF INTEREST TO THE VEHICLE INDUSTRY.

- 950,089—Track for Carriage Doors. Ell Barth, Nevada, Ohio.
- 950,429—Pneumatic Tire for Vehicle Wheels. George W. Beldam, Ealing, England.
- 950,038—Attachment for Buggy Tops. Wm. P. Bliss, Aurora Springs, Missouri.
- 950,127—Vehicle Rim. Isaac Broome, Trenton, N. J.
- 950,438—Singletree. Wm. L. Collins and P. D. and W. K. Sheppard, Cairo, W. Va.
- 949,888—Rubber Tire for Vehicles. Richard J. Evans, Franklin, Pa.
- 950,262—Lock for Vehicles. David Froehlich, New York, N. Y.
- 949,928—Wheel Hub. George W. Grooms, Ottumwa, Iowa.
- 950,172—Tire-repair Device. John C. Herman, Chicago, Ill.
- 950,046—Draft Evener Attachment. Charles L. Hofwitz, Salem, S. D.
- 949,903—Spring Tire. Leonard F. Kenney, Avondale, Ala., assignor of one-third to O. E. Heath.
- 950,292—Sleigh. Bertalan Klein, Ralphon, Pa.
- 950,237—Vehicle Storm-Front. Frank L. Moore, Indianapolis, Ind.
- 949,833—Shock-Absorber. Robert G. Mueller, Yonkers, assignor of one-half to F. Geh, New York, N. Y.
- 949,962—Vibration Arrester. Wm. F. Nichols, Chicago, Ill.
- 950,299—Resilient Wheel. Max C. Overman, New York, N. Y.
- 950,407—Vehicle Wheel. Nicholas Schenk, St. Louis, Mo.
- 949,846—Automobile Lamp. Charles J. Schmalzried, Knoxville, Pa.
- 950,144—Transmission Gearing. Temple S. Scott, Chicago, Ill.
- 950,061—Spring Seat. Wm. B. Speir, assignor of one-half to W. Coe, Rosalie, Texas.
- 950,195—Extension Seat for Carriages. Isabelle A. Sturtevant, Center Harbor, N. H.
- 950,267—Motor Truck. John Taylor, Colonie, assignor to Taylor Electric Truck Co., Troy, N. Y.
- 950,416—Wheel Tire. Arthur G. Thomson, assignor of one-half to A. Sutton, San Francisco, Cal.
- 950,417—Tire Armor. Arthur G. Thomson, assignor of one-half to A. Sutton, San Francisco, Cal.
- 949,947—Pneumatic Tire and the Like. Wm. J. Thorold, London, Eng.
- 950,361—Fastener for Wagon Seats. Patrick W. Woods, Helena, Mont.
- 950,985—Tire, Rose and S. Basch, London, England.
- 951,053—Cushion Tire for Vehicle Wheels. Wm. E. Budd, Chatham, N.J.
- 950,840—Draft Equalizer. Frank Clark, Marshall, Okla.
- 951,089—Collapsible Wagon Hood. Clay C. Cooper, Smith Mills, Ky.
- 951,000—Spring Controlled Vehicle Link. Hugh Ewing, Columbus, Ohio.
- 950,818—Steering Gear. Wm. E. Geyer, Cambridge, Mass.
- 951,070—Shock Absorber. John H. Gibson, Greenville, Pa.
- 950,486—Brake Shoe. Otto A. Koenig, assignor to Koenig Wagon Company, Kansas City, Mo.
- 951,008—Carriage Iron. Lewis Kuchenbecker, Waltham, Minn.
- 950,943—Three-Horse Evener. Thomas S. Moffett, Spokane, Wash.
- 950,949—Automobile. Frederick P. Nehrbas, assignor to E. R. Thomas Motor Company, Buffalo, N. Y.
- 950,733—Thill Coupling. Frank A. Strodel, assignor to C. C. Bradley Sr. Syracuse, N. Y.
- 950,583—Combined Carriage and Sled. Warren W. Vicks, Rome, N. Y.
- 951,520—Resilient Support for Carriage Tops. Charles L. Barnum, Kiefer, Okla.
- 951,588—Automobile Fender. James E. Bennett, Chicago, Ill.
- 951,173—Vehicle Wheel. Leon Bloch, Cleveland, Ohio.
- 951,361—Whip Holder. Merton G. Brown, Sandusky, Mich.
- 951,210—Draft Equalizer. Benjamin J. Brunke, Campbell, Neb.
- 951,730—Whip Lock. Emet Goff, Hillsboro, Oregon.
- 951,533—Attachment for Vehicle Wheels. Gilford E. Kimmel, Rutland, Indiana.
- 951,284—Wagon Rack. Charles Linguist, assignor of one-half to R. C. Kemp, Waterford, Ont., Canada.
- 951,692—Sleigh-Runner. Johannes Melby, Backus, Minn.
- 951,376—Shock Absorber. Frank W. Merritt, New York, N. Y., assignor, by mesne assignments, to Auto Appliance Manufacturing Company.
- 951,707—Automobile Starter. Charles A. Smith, Brattleboro, Vt.
- 951,429—Vehicle Pole. Alonzo L. Sumner, Guthrie Center, Iowa.
- 951,384—Vehicle Wheel. Arlen H. Towle, Lansing, Michigan.
- 951,929—Wagon Box Fastener. Fred Abrams, Minden, Neb.
- 951,981—Felly Finishing Machine. Charles W. Borg, Rock Island, Ill.
- 951,938—Spare Wheel for Vehicles. Edward T. Burrows, Portland, Maine.
- 951,802—Resilient Wheel. Charles J. Craig, Lathrop, Mo.
- 952,000—Wagon Attachment. Alexander C. Davis, Battle Ground, Ind.
- 952,073—Tire Protector. Lina Faber, San Francisco, Cal.
- 951,883—Dirigible Wheel Mount. Stephen B. Gray, deceased, Jacksonville, Ill., B. S. Gray, executor.
- 952,038—Wheel-Truing Device. Elmer E. Green, Walkerville, Md.
- 952,039—Non-skid Tire. Lemon Greenwald, Buffalo, N. Y.
- 952,012—Wheel. Henry Mayer, assignor of one-half to F. Mayer, St. Louis, Mo.
- 952,131—Bow rest for Vehicle Tops. Nell J. McLean, Portland, Oregon.
- 952,207—Vehicle Fender. Christian Molin, assignor to S. S. Weyl, Amsterdam, Netherlands.
- 952,014—Non-slipping Tire. Charles F. C. Morris, Stamford Hill, London, England.
- 952,132—Tire. John Neary, assignor to Kokomo Rubber Company, Kokomo, Ind.
- 952,353—Wind-Shield. Henry B. Pitner, Dubois, Pa.
- 952,380—Reach Connection for Vehicles. Wm. St. Peter, Damar, Kan.
- 952,143—Driving Gear. John M. Saller, Janesville, Wis.
- 952,019—Vehicle Wheel. Wm. Schuetze, Pittsburg, Pa.
- 951,870—Tire and Tire-Tread Construction. Paul E. Wirt, Bloomsburg, Pa.
- 952,025—Thill Coupling. Alfred H. Worrest, Lancaster, Pa., assignor to Metal Stamping Company, New York, N. Y.

Copies of above patents may be obtained for fifteen cents each, by addressing John A. Saul, solicitor of patents, Fendall Building, Washington, D. C.

Judging from the character of the declarations which are being made by the makers of 1911 automobiles, descriptions of which are now rapidly coming out, the newer models are more in the nature of 1910 models refined than outright new designs.

NEW HOOD.

We read of a new double-extension hood named the Kopalps that may possess features of interest to the builder. It can be raised or lowered very quickly, and here is the explanation.

When open or closed the hood is supported at only one point at each side of car, just behind the rear side doors. From here to the front of the car, the hood is supported and extended by an ingenious arrangement of the lazy-tongs principle, operated as follows: Standing on the front of the footboard, one simply pulls the strap for affixing the hood, when opened, and before one can realize it, the hood is in position. There is no reason for the passengers in the rear seats to get out; they are not even incommoded. The hood lifts over their heads, and affixes itself in position quite automatically. The straps are fastened to the dashboard by small clips. The operation for putting the hood down is as simple or even more simple than the operation of raising it. One of the lazy-tong levers is merely pulled down gently, when the hood folds itself up, and when it is in this position it presents much the same appearance as any ordinary hood.

CAESAR'S COMMENTARIES.

The Consolidated Rubber Tire Co., in its clever folders, has enlisted the services of J. Caesar as a "Sandwich man" to tell the merits of Kelly-Springfield tires to carriage buiders. When last heard from the noble Roman was on his way from Rome to Dakota which ought to "tire" him well enough.

FLYING MACHINES.

We have received from the publishers, Charles C. Thompson Company, Chicago, "Flying Machines; Construction and Operation," by W. J. Jackman and Thomas H. Russell. We shall review it in a succeeding issue.

ENDURANCE CONTEST.

The New Jersey Automobile Club held an endurance contest on June 14, starting the cars from the club house in Newark at five in the morning. Entrants were numerous and results gratifying.

TO QUENCH GASOLINE FIRE.

In addition to the sand, dirt, or anything to shut off the supply of oxygen always recommended, it is found that slaked lime is very effective.

RECENTLY EXPIRED PATENTS OF INTEREST TO THE VEHICLE INDUSTRY.

- Patents Expired May 9, 1910.
- 496,853—Dumping Wagon. Joseph Caneron, Findlay, Ohio.
- 496,861—Raising or Lowering Device for Buggy Tops. Jamison F. Collins, Oak Park, Va.
- 496,932—Dumping Wagon. Edward Gabel, Deerfield, N. Y.
- 497,173—Buggy Tops. Richard C. Groom, Cobb, Ky.
- 497,284—Thill Support for Vehicles. Patrick McDonald, Brookline, Mass.
- Patents Expired May 16, 1910.
- 497,372—Vehicle Spring. David T. Ensign, Cortland, N. Y.
- 497,309—Equalizing Device for Vehicles. Henry B. Cross, Syracuse, N. Y.
- 497,487—Vehicle Spring. Charles L. Bellamy, Arlington, N. J.
- Patents Expired May 23, 1910.
- 497,765—Shifting Seat Carriage. Joseph T. Clarkson, Amesbury, Mass.
- 497,894—Trotting Sulky. Samuel Rowe, London, England.
- 497,995—Wheel Tire. Frank W. Tucker, Winthrop, Mass.
- Patents Expired May 30, 1910.
- 498,255—Vehicle Wheel. Alvin S. Flint, Hartford, Conn.
- 498,270—Vehicle Spring. John M. Holler, Albany, N. Y.
- 498,347—Vehicle Brake. George H. Ziegler, Spring Hope, Pa.
- Patents Expired June 6, 1910.
- 498,790—Racing Sulky. Theodore Harrington, Southbridge, Mass.
- 498,841—Vehicle Brake. Nelson E. Bradford, Pittsburg, Pa.
- 498,958—Wagon Brake. Levi E. Lane, Lyons, N. Y.
- 499,086—Spring Connection for Vehicles. Samuel R. Bailey, Amesbury, Mass.

The above lists of patents, trade marks, and designs of interest to our patrons, are furnished by Davis & Davis, solicitors of American and foreign patents, Washington, D. C., and St. Paul Building, New York City.

SEAT MEASURING MACHINE.

Builders who construct bodies to order for particular patrons have a leg-measuring machine that gives the knee room dimensions with accuracy, as well as the correct height of steering column, as here illustrated. The framework shown in the illus-

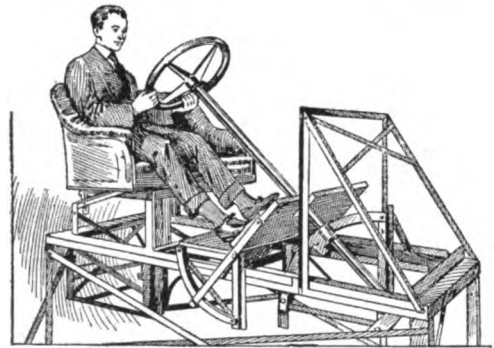

tration is the adjustable means by which one concern makes measurements for such cases. The seat can be raised and lowered, the footboard tilts to different angles and the steering wheel rod can be shortened or lengthened.

OPENS OFFICE IN DETROIT.

The Grant-Lees Machine Co., of Cleveland, O., making helical timing gears, transmissions, steering gears and differentials, has opened a branch sales office in Detroit, Mich., at 1001 Ford building.

POLICE.

A contract for a new automobile patrol wagon for use in the police department at South Bend, Indiana, was awarded the Studebaker Automobile Company. The new wagon will be a Studebaker-Garford, forty horsepower, four-cylinder engine. The vehicle will be lighted by electricity throughout.

SOON READY.

From all reports it will not be long before the Racine-Sattley Co. is turning out their new cars. Several fancy bodies have been built at the factory. The motors will be erected at the Holbrook-Armstrong factory, and the rest of the cars, including the springs, frames, bodies and tops will be built at the Sattley Co.

STILL AFTER THE RATES.

Recognizing that the freight rates controversy, in spite of the truce arranged by the President with railroad executives of both Eastern and Western lines, will not be finally settled until after the proposed advanced rates are passed upon by the Interstate Commerce Commission, the shippers intend leaving no stone unturned to secure favorable representation at Washington.

NEW SELDEN LICENSEE.

Announcement is made that the Inter-State Automobile Company, of Muncie, Indiana, has been granted a license under Selden Patent No. 549,160. The Inter-State Company markets cars selling at \$1,750 and at \$2,000. Thomas F. Hart is president and general manager. The other officers are J. M. Maring, vice-president, and Otto Holdren, secretary-treasurer.

ROAD MAPS.

Chas. E. Miller, New York city, has just published a road map entitled "Through the Berkshires, Eastern New York, Western Massachusetts, Connecticut and Vermont." This map is printed on bond paper with the principal routes in red.

MEASURING GASOLINE.

The consumer enables the observer to keep an accurate account of gasoline used, also shows in what proportion it is used. It has been discovered that a car which averages 25 miles to the gallon will do no more than six miles to the gallon up a long hill of about 1 in 8. Another and more powerful car which can average 16 miles to the gallon over give-and-take roads drops quite easily to 2½ miles to the gallon going up a similar hill. These figures surprise many designers. Yet they are only to be accepted because a touring car with a real touring body and in touring trim uses only between half and three-quarters of its maximum power during most of the journey when it is making a good average fuel consumption. Allowing for the short distance during which the engine consumes no fuel, as when running down hill, in order that the average may be what it is, there must clearly be a heavy rate of consumption for short periods, as when going up hill. The light and heavy rates combined produce the average.

This is merely a point of interest, and not of importance, which has been brought out by the use of the consumer. The value and utility of the instrument are most clearly defined in making investigations of the particular rate of consumption of a car. It shows by its readings whether a car is doing well.

Observations on a number of different cars have brought out one fact that will have to be considered very seriously by many manufacturers. The fuel consumption on cars in which gasoline is fed to the carburetor by pressure is greater than when the feed is by gravity, other conditions being the same. Inherently one system is as good as the other. So far as bench and road tests under manufacturers' supervision show, the consumption in each of the two systems is practically the same. The trouble is that when a car has left the factory or show rooms, and is put into service, the conditions which manufacturers have in mind are in by far the greater number of cases completely altered. And though the manufacturers cannot be blamed for what happens to a car in private service they must take steps to ensure that the feed system under pressure should not so easily be deranged by ignorant drivers.

Upon investigating the reasons of the superiority of the gravity feed system it has become clear that the fault of the pressure feed system is that the pressure behind the gasoline is easily made too great. A pressure of 1 lb. per square inch represents a head of 3 feet. Such a head is never obtained in the gravity feed system of the car. Therefore a pressure of 1 lb. per square inch should suffice if the feed is to be under exhaust or air pressure. Manufacturers provide in pressure-feed system not less than 2 lbs. per square inch, and very frequently 3 lbs per square inch, that is, the equivalent of 6 feet or 9 feet head.

When the exhaust pressure is used, the pressure inlet valve of the reducing valve will get dirty sooner or later—sooner if the driver be careless and later if he be careful. When it is slightly dirty, it will not seat properly and the pressure goes back, not necessarily into the main pressure pipe, but leaking perhaps past the valve spindle. When the pressure is failing, the driver imagines generally that the relief valve has become loose and is the cause of the loss of pressure. He screws it down, in some cases as hard as it will go. The pressure goes up to 4, 5, or 6 lb. per square inch, the latter being equivalent to a head of 18 feet of gasoline.

Making a general statement, it may be said that on cars of about 25 h.p. the fuel piping is large enough to deliver 100 pints per hour to the float chamber under a pressure of 3 lbs. per square inch. This rate of feed would do quite well for a car of 100 h.p. traveling at full speed for an hour. The piping can, therefore, deliver about 5½ times as much as the engine needs when running at full power. What happens? The float cannot balance immediately owing to inertia. Before it can close the inlet the level of the spirit in the float chamber will have risen a few millimeters above the top of the spraying jet. Flooding will therefore take place.

HOW IT BECAME DE DION-BOUTON.

The cars made by the concern of this name in France are of world-wide fame. It will be curious, a lending of personal note of interest, to learn how the enterprise happened to be born. Here is the account:

The Marquis de Dion comes of one of the oldest of the noble houses of France. In 1881, the Marquis de Dion, then only the young Count Albert de Dion, a well known sportsman and clubman, fond of pleasure and fetes, but devoted to anything which concerned machinery, was sauntering along the boulevard with his friend the Duke de Morny, with whom he had organized a ball, was looking in the windows of the toyshops for accessories for the cotillon, when, suddenly, among the various objects displayed, he noticed a little steam engine. Its happy design and perfect execution struck him, and enthusiasm awoke in him a childish passion, that of mechanical toys which he had constructed in his leisure hours as a boy. Surprised, he found out who it was that made this pretty toy—it was Bouton, of Clignancourt. He went there and found an incomparable workman. To the great scandal of his own people he associated himself with the humble workman, who, thanks to the Count's money, moved to the Avenue Malakoff, where soon after were opened the first "Ateliers de Dion-Bouton." Thus was founded the firm which, growing larger and larger, now employs 3,000 workmen and pays out 10,000,000 francs in salaries annually

CABRIOLET FRONT SEATS.

The body development is growing fast into carriage forms.

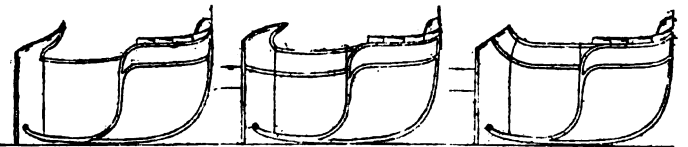

Here are shown designs for cabriolet front seats with modifications of dashboard.

TO CALCULATE THE HORSEPOWER.

A simple formula and one always useful and speedy in calculating the horsepower of a gas engine is to square the cylinder bore and multiply by the number of cylinders and divide the result by 2.5. It is almost inappreciably less accurate than the more elaborate formulae so long as applied to standard engines.

Piston speed is not an element of the formula itself. But formula is based on 1,000 feet per minute piston speed; that is, in the case of two motors having the same number of cylinders and the same cylinder bore, but different length of stroke, it is assumed that the motor with the shorter stroke will make a greater number of revolutions per minute relatively.

As per example the application to a four cylinder motor with a five inch bore would be as follows: square of 5 inches equals 25; multiplied by four, the number of cylinders, equals 100; divided by two and one-half, gives 40 horsepower.

FULL OF AUTO BUSINESS.

Crane & McMahon, incorporated, are doing a fine business in woodwork for automobiles. Their South Carolina mills can't get out the goods fast enough for the northern wheel factories of the company to work up into finished product. As a sample the company received in one day's mail orders for 4,000 pieces for auto rims.

'ES HENGLISH.

The Mitchell car that has achieved such a sturdy reputation for durability and other good points is designed by John Bates, an Englishman, who learned his trade in his native land.

PRODUCER GAS AUTOMOBILE.

Great strides have been made within the past few years in the development of the producer gas engine. Its great feature is economy of fuel. The first producer-gas automobile underwent some pretty severe tests in Scotland recently. As can be seen by the illustration it is of the char-a-bancs type. Its total weight with passengers and a day's supply is over five tons. As a result of the tests made to show its consumption of fuel on a run of $35\frac{1}{4}$ miles, the engine used 189 lbs. of anthracite coal, which at the rate of \$4.80 per ton, would mean that the entire fuel cost for the trip would be about 47 cents. Gasoline costs 26 cents per gallon in Scotland, and the same load run over the same course by a gasoline engine would take about 26 gallons of this fuel, making the total cost \$2.86. A comparison of the fuel costs, therefore, shows that the producer-gas engine operated at one-eighth the cost of a gasoline engine under the same conditions.

Nothing distinguishes the appearance of the producer gas automobile from the ordinary type except the case between the

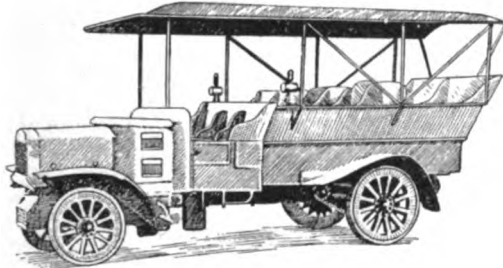

bonnet and the dashboard, which is in no way disfiguring. This case contains the producer with sufficient anthracite for a 10-hour run. At the bottom of the case is the door for lighting up the producer, and above this is the hopper, the lid being lifted for filling. Air is forced through the bottom of the hopper by a blower, and as the gas rises to the top of the hopper, it is strained and led through a pipe to the cleaner at the back of the car. From here it goes to a suction-box where it is mixed with air, and thence to a four-cylinder engine working with a compression of 115 lbs. The water is fed to the producer by a specially designed pump, which is controlled by the same wire that actuates the throttle, so that the gas is kept at a uniform quality at all speeds.

One point observed during the trials was that the exhaust was entirely free from smell and quite invisible. If this can be relied upon in ordinary working it would remove one of the chief objections to producer gas for motor vehicles, since it implies that there is no carbonizing of the valves or cylinder walls, which would cause irregular working and necessitate frequent cleaning.

SOMETHING ABOUT THE ROTARY.

There is a peculiar circumstance that controls discovery. As soon as the pioneer inventor practically perfects something many have been working on, there seems to be a series of inventions following fast. The psychic wave gets in its work.

The second claimed success in this new field is by way of Philadelphia, and we have some stated claims that give a concrete idea of what is doing in this new field of applied mechanics.

We learn that this particular engine is rotary throughout, that is, it contains no oscillating or reciprocating parts whatever. It allows of the development of great power in little space. For instance, an engine that will go in the crown of a hat will develop fifteen horsepower, and work up to 4,000 revolutions.

The feature of this particular engine is disc-enclosed in its case, performing all the functions of a gas engine during the rotary motion. The fuel consumption is reduced one-half over standard types, and the production cost is smaller. If these claims make good, we will see some great advances in motor car construction.

REASON FOR THE NOISE.

An English writer knows why our planetary gears are noisy, and why the English kind are not. Why not heed for the sake of improvement? In almost all cases, where epicyclics have been employed in America, they have been carried on the engine shaft of an engine set across the car, with the result that the designers have had an exceedingly little space to work in and have, as a result, cut down tooth faces and bearing lengths to the utmost, while in many of them practically no provision for lubrication or for keeping the dust out has been provided. Then again, many of the American constructors made these gears of the very cheapest materials they could obtain, some even casting the pinions, with a collective result that, dust, readily entering, wore both wheel faces and bearings, and directly this wear occurred, rocking on the very short bearings commenced, and as soon as rocking commenced, noise also commenced with it. although in most cases, owing to poor workmanship, this was strikingly apparent from the start. Now, contrast this with the practice of those British manufacturers who are employing this type of gear, and we see that, with scarcely an exception, they are using the gear with a conventionally-arranged engine, and thus have all the length of the car between the engine and differential in which to arrange their gearing, with the result that there is no incentive whatever to cut down either tooth faces or bearing surfaces, and, as most of them have, with the British characteristic of thoroughness in fitting and finish and in the choice of material, built their car accordingly, and have designed them so that the gear itself forms an oil-tight casing in which the internal members operate, the epicyclic gear is not only absolutely dustproof, but absolutely silent in use, and, instead of being, as our American friends summarize it, "more economically manufactured," its production cost is probably twice that for which an ordinary sliding gear-box and gear set can be manufactured.

THE UNITED STATES MOTORS COMPANY.

The news accounts of absorptions by the big United States concern are confusing in their multiplicity. It seems, from a recently published interview with the head of the corporation that the combination is being formed on very conservative lines with no stock-jobbing attachments. The companies so far taken over make non-conflicting types of vehicles so that the corporation can round out a product on lines of severe economy.

Something of a departure is to be made in the electric department of the Columbia Motor Car Co., in that the company will make and supply complete electric chassis without bodies. These chassis will be furnished to carriage builders and others who may wish to supply the body work and market the complete vehicles in their own way, a large field of this kind having been created by the desire of many carriage builders and carriage dealers to engage in the automobile business in some form. Their special facilities for making bodies to order and for reaching customers of the type who take most kindly to electrics are regarded as favoring the arrangement by which they may become wholesale customers for electric chassis without bodies.

ATLANTA COMPANY QUIETLY "FOLDS ITS TENT."

Although the Southern Motor Car & Truck Co., of Atlanta, Ga., occupied luxurious salesrooms and made a brave outward show, its business does not seem to have been very satisfactory from a financial point of view. After considerable bickerings with the landlord and other creditors, the southern company decided to quit the automobile business, and decamped. Despite their evident hurry to leave, the leading spirits of the enterprise tarried long enough to carry away everything of the slightest value, leaving to the creditors a perfectly bare and empty building.

ANOTHER ABSORBED.

The latest company to be absorbed by the United States Motor Co. is the Dayton Motor Car Company. The estimate of its worth is \$2,500,000; output, 8,000 cars. This firm also controls the Courier Company (which is included in the sale to the U. S. Motor Company), output 1,500 cars.

Now that the organization is complete, the roster shows that it comprises a total of sixteen plants, now built or building. These are: Maxwell-Briscoe Company, five; two at Providence, two at Tarrytown, one at Newcastle; Dayton Motor Car Company, three; two Stoddard-Dayton, and one Courier at Dayton; Brush Runabout Company, two, both in Detroit; Briscoe Mfg. Co., two; one in Detroit and one in Newark, N. J.; Alden-Sampson Mfg. Co., two; one in Pittsfield, Mass., and one just started in Detroit; Columbia Motor Company, one in Hartford, Conn.; Gray Motor Company, one in Detroit.

These sixteen plants now employ 12,500 men. Benjamin Briscoe, head of the enterprise, is quoted as follows:

"We expect to produce between 50,000 and 60,000 cars for 1911, or a total business of approximately \$55,000,000, the employes at the Columbia plant being doubled, those at the Dayton works being increased to such a number as will enable us to double the number of Courier cars now turned out, while all the other factories will be correspondingly increased."

The new Detroit plant for the Alden-Sampson Mfg. Co., which will be the real headquarters of the power wagon end of the United States Motor Company, will consist of one long, narrow single story building of reinforced concrete construction, with a smaller separate office building. The main shop building will be 1,000 feet long by 175 feet wide. Commenting on the Detroit situation, Frank Briscoe said:

"In the various Detroit plants we will employ over 6,000 men by the first of the year, we are going to build a great big addition to the Brush plant on Oakland avenue that will be shaped like a letter U. Each leg of this will be 1,050 feet long and the connecting link 450 feet long, the whole structure being 152 feet wide, one story in height and of the saw-tooth roof construction, which gives the maximum amount of interior light and convenience for all phases of manufacturing."—The Automobile.

ENTERS COMMERCIAL VEHICLE FIELD.

With the reorganization of the Clark Power Wagon Company and the merger with it of the Ferguson Motor Company, the capitalization of the company has been increased from \$50,000 to \$500,000. The company will enter the commercial field with an adequate plant at Lansing, Mich. The men who compose the company are Frank G. Clark, president, who was the sole owner of the concern formerly known as Clark & Company. Mr. Clark became interested in the future of the commercial car some time ago and the present company is the result of his determination to go into the manufacturing of that type.

R. A. Radle, of Detroit, is treasurer of the new company. Mr. Radle is well grounded in the mechanical end of the business and has demonstrated much ability in selling. He is to be factory manager and in addition, he is connected with the Radle-Clark Sales Company of Detroit, which is closely allied with the Clark Power Wagon Company.

His history in the trade has been brilliant in both directions and much of the success of the Grabowsky Power Wagon Company, and the Rapid Motor Vehicle Company are credited in a measure to his efforts.

John Demmler, chief engineer, has been identified with the Packard Motor Car Company and was formerly connected with a number of European factories in important capacities.

B. H. Warner, superintendent of machines for the Sheffield Car Works at Three Rivers, Mich., for several years, has been named vice-president and superintendent.

The car which will be turned out is a twenty horsepower, two-cylinder vehicle having a load capacity of 1,000 pounds.

DOUBLE PURPOSE BODY.

To do away with the weight of an enclosed body and secure the protection against weather such body affords we here show an English idea for surmounting objections.

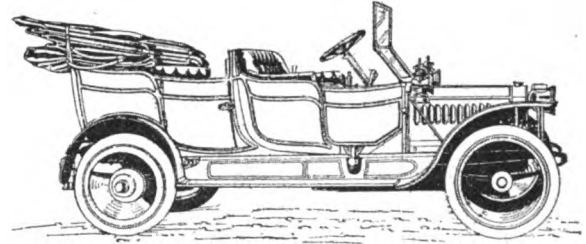

The first illustration depicts body with hood dropped and in touring car condition. The record shows same body converted into closed car.

By raising the hood and middle screen and fixing side win-

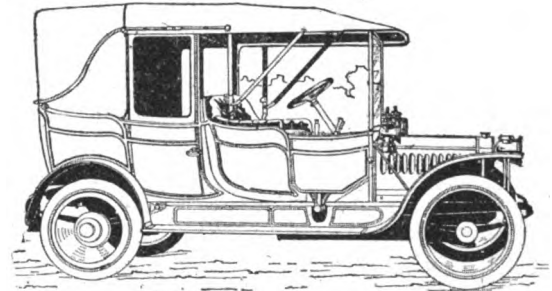

dows above the doors a closed vehicle body is had of little more weight than an open body. The middle screen may be fixed at any height, and the side windows may be omitted, thus giving nice protection to rear seat passengers when hood is lowered.

LOOKING FOR A HOME.

The Fal Motor Car Co., of Chicago, Ill., is casting about for a factory in one of the smaller Illinois cities, and the selection will depend to a great extent on which will offer the most substantial and prompt inducements. Waukegan, Ill., is considering the company's proposition, and a mass meeting has been called to determine whether its citizens are willing to absorb \$200,000 worth of the company's stock.

THE SUCCESSOR.

The Detroit Airless Tire Co., recently incorporated under Michigan laws with \$1,500,000 capital, is to succeed to the business of the Dayton Airless Tire Co., of Dayton, Ohio, from which city operations will be transferred to Detroit. A new plant will be built, which is expected to be in operation in September.

DETROIT BRANCH FOR HARTFORD PARTS.

The Hartford Auto Parts Co. of Hartford, Conn., has opened a branch office in Detroit, Mich., in order to be closely in touch with the western trade in the supplying of cone clutches, universal joints and other parts.

PLANT FOR HEWITT IN DETROIT.

The Hewitt Truck Co., which is owned by the Metzger Motor Car Co., of Detroit, Mich., is to have a large factory of its own on a 40-acre site in the northwest section of the city, in the vicinity of Hamilton boulevard and the Detroit Terminal Railroad's outer belt. The first building is to be 1,200 feet in length, and so arranged that additions may be attached conveniently. The plant will make trucks of from three to ten tons capacity.

METHODS TO PREVENT DUST-RISING.

Ever since the introduction of the motor car as a road vehicle of strong progress there has continually been thrown up one crop of defects following close upon the heels of another, until improvement upon improvement has reduced the list to those which time alone can bring under right solution. Among these the dust problem is strikingly present. Invention can without doubt, help the construction of roads to a solution of the difficulty, by hinging to the construction in the accessories of a car's fittings a means by which the rising of dust through the wheels traveling along roads can be subdued in volume.

In many cars a dust wing has been fitted after the design shown in Fig. 1; the body is made in its back panelling with a rocker as at C, and with a return line to run in to the full depth of the wing down to the point at D. To the continuation of the wing's line, the width below the chassis line is bolted to the chassis frame quite independently of the body, but to form the wing's

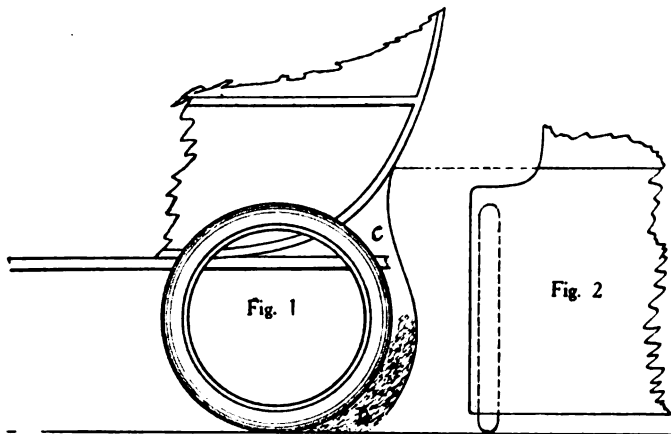

curvature as explained in the diagram. Fig. 2 shows the wing's formation behind and its projectional position to the wheel from the body outwards.

On a car being driven into speed on a dry road the surface of which is of a thick coating of sand, a dust cloud is the result from the wheels' speed, which is both dangerous to road traffic as well as being unhealthy.

To cure this defect many experiments are being made in road construction, as absorbents of the road's grindings as the resultants of traffic. In this, tar has played an important part, in preventing the solid composites of the road from being crushed or powdered, owing to its elusive surface and absorbing properties.

The reconstruction of roads with tar as the controlling composite is one of these systems which need a lot of forethought bestowed upon it, quite beyond its immediate benefit to motor-ing.

Tar, being largely charged with ammonia, the mud thrown up onto a motor body richly painted has a most destructive effect on the varnish, and if we associate with the mud road grindings, which are full of the iron composites of stone, and the wearing atoms from iron tires, together with the grease residue of animal and bituminous matter, we have to fight with a strong enemy to the painting life of a motor carriage, or any carriage with a varnished surface to its painting.

In these things, of course, it is not to be expected that road builders should have expert knowledge beyond endeavoring to make a road as dustless as it is possible to make the highway a permanent way.

It is as a help to road making in meeting the new trouble of motor traveling, that the method of fitting a dust deflector, as is shown in the illustrations Fig. 1 and Fig. 2, has been invented.

The principle is to make the wing generate a vacuum from the speed, which will cause the dust to fall of its own weight, and dead to the windage set up by the speed of the wheels. The idea has merit in its effort to meet a public necessity, and as it is developed in conjunction with the altered conditions of road

construction, it will make itself an indispensable fitting to every motor carriage. The fitting is a step in advance to a solution of the dust problem, and from this standpoint will keep The Hub subscribers up to date in the fitting up of accessories that make for the goal of perfection.

AUTOS AND COTTON.

"Automobiles require about a million bales of cotton annually," says Mr. Holmes, of Jackson Automobile Co., "of which 300,000 bales are used in the manufacture of automobile tires and protectors, 35,000 bales for the manufacture of 'leather' seats and cushions, 10,000 bales for the stuffing and upholstering, while the remainder is used for the manufacture of auto clothing, slip covers, insulating of copper wires, tool bags, tool rolls, waste and mercerized rain clothes. Take the question of automobile lubricating oils alone, millions of yards of duck 40 inches wide are used annually for the purpose of filtration, while mostly every car owner has a canvas cover to put over his car while standing in the garage, and the lamps and other bright parts are covered in rainy weather with enameled water-proof covers. All this uses up countless bales of cotton so that the automobile uses as much, if not more, cotton than the railroads and other allied industries, and has helped to increase the world's demand for the commodity by three million bales in hardly more than five years."

ACCELEROMETER.

A new measuring mechanism of use to makers of motors is the above. It tests the power of an engine in service, the best way. There are many things that can with advantage be learned by the aid of this instrument. The efficiency of various systems of braking can easily be ascertained. By measuring the retardation due to frictional resistances when the car is running with the power cut off, the general condition of the car can be shown and whether parts are much worn or are out of true. Actual figures of road resistance can also be obtained. There are, in fact, nine or ten different uses to which this instrument can be put and for each of them there is the great advantage that the figures which are sought are obtained either by the direct reading of the scale the dial or by a very simple calculation.

PUTS ON MORE MEN.

The Continental Motor Manufacturing Company, Muskegon, Mich., within a short time will add to its present force of 700 men a crew of 300 machinists, part of whom will work nights, the balance working days, as two shifts are necessitated through the pressure of business. It has just completed extensive additions to its plant.

REDUCED.

Cleveland Electric Vehicle Co., has reduced its capital from \$300,000 to \$50,000.

RUST ON RIMS.

A preventive of rust on wheel rims which is highly recommended, is to paint them with a mixture of shellac and finely pulverized flake graphite, mixed to a stiff paste. After treating the rims as indicated, it will be found that they are very even and a waterproof film of great smoothness is formed.

PLANTED IN FORT WORTH.

The Overland Automobile Company has put an assembling plant in Fort Worth, Texas. Four hundred men will be employed.

COAT RAIL BAG.

The accessories supplying the polite necessities for the interior furnishings of the automobile are not much in themselves, but they add to the convenience and comfort of occupants greatly, and are an important addition to the completeness of the car's equipment.

A nice article, well designed and conceived is the coat rail bag here illustrated, made by the Ajax Trunk and Sample Case Co., of New York City.

The bag is made of English grain enameled duck. The in-



side pocket will contain rubber coat, dusters, etc. The series of outside pockets shown will take care of goggles, gloves, maps, etc. If no present use is made of the box it may be rolled and fastened to the rail. We think makers would be glad to supply this if only as a talking point showing completeness in every detail.

SPEAKING OF CHAIN DRIVE.

Generally this means of driving is considered as from gear box to road wheels by side chains, but a writer in Motor (English) discusses the two-step way from engine to gear box and box to live axle. He says (he is a manufacturer): Excellent results accrue from this system of drive, giving efficiency, silence and freedom from cleaning. A drive by means of side chains to the rear wheels, on account of its close proximity to the mud and dust thrown off by the road wheels, is not giving the chains even a chance of running well. A good deal has been said lately of the noise set up in gearboxes and bevel drives. True, there are quiet cars, but it is well known that these are more the exception than the rule. We obtain silence in the drive for the reason that the gearwheels in the gearbox do not revolve at engine speed, being geared down 2 to 1 from engine to gearbox. It is well known that a gear running noiselessly at a slow speed will make itself heard when the speed is doubled, although the gears, as gears, may be as perfect as they can be commercially produced. The gearing down of the gearbox has a further advantage in that the relative difference in speed between the road wheels and gear shafts is not great; hence the change from one gear to a higher or lower is easier and quieter under all circumstances.

Wear in chains can be ignored. It is merely a question of having the size of the chains right up to their work to obviate wear, usually termed stretch. There is a certain amount of "give" in a chain when power is suddenly applied, acting to a degree as a spring drive, and this is most distinctly noticeable when the engine is running slowly at full throttle, such as is sometimes the case when nearing the top of a hill and the engine is allowed to temporarily slow down to avoid changing down on the last few yards. In a cardan-shaft-driven car, the impulses of the engine can then be distinctly felt, and the absence of this "tugging" is most noticeable in the two-step chain drive. It is well known that even the best chassis whips under the circumstances of an uneven road. This can easily be proved by putting a jack under one extremity to see how far one cor-

ner can be lifted before any other parts of the chassis even move upwards. This torsion of the chassis is taking place as long as a car runs on the road, and we are thus transmitting power from the engine to a rear axle, which is constantly changing its alignment vertically and horizontally by means of gearing. The cardan-shaft is intended to allow for this movement, but it is well known that power is most efficiently transmitted in a straight line, and any deviation from this means loss, resulting in waste of power and wear of bearings. The chain is a flexible power transmitter made up of many parts, each part allowing for a slight deflexion, with the result that, where whip or twist is inevitable, as it is in a motor car chassis, the chain is the most practical and kindest medium. Apart from improvements in detail, the cardan-shaft and bevel drive have remained constant in the design of motor cars. The chain, as a chain, has, however, been vastly improved both in design and principle. The inverted tooth type of chain or silent chain, as it is generally termed, is entirely different from those chains that have in the past been employed in motor car drives.

HEARING SET FOR JULY 19.

At a meeting of the Association of Licensed Automobile Manufacturers June 18, it was reported that the final hearing on the interlocutory decree before Judge Hough in the Ford and Panhard cases has been definitely fixed for the morning of July 19. The testimony on both sides in the supplemental bills and answers has been closed, and now only awaits the hearing of the application for the entry of decrees.

FOUR A WEEK NOW, MORE LATER.

The Embree-McLean Carriage Co. has begun active work in the manufacture of the Embree-McLean automobile. Four cars a week are being turned out, and it is expected that soon the output will be a car a day. H. H. McDonald has just been appointed automobile sales manager for the company, C. T. Schaefer is designing engineer and J. E. Ellison factory manager. These three men were recently with the St. Louis Car Co. and are experts.

HOW TO LOCATE ENGINE POUNDING.

In endeavoring to locate an engine pound, a good scheme is to cut out the ignition in all but one cylinder, running on one at a time until each unit has been tried separately. A loose connecting rod or wrist pin bearing, or even a loose crank shaft bearing will be located as soon as that particular cylinder takes up its work. Final determination as to the exact nature and location of the fault should be made with the aid of one of the several sounding rods which are on the market.

Wants

Help and situation wanted advertisements, one cent a word; all other advertisements in this department, 5 cents a word. Initials and figures count as words. Minimum price, 30 cents for each advertisement.

HELP WANTED.

Wanted—Foreman painter, in factory building 1,000 buggies annually. Must be hustler. Must furnish references. Address F. J. C., care The Hub, 24 Murray St., New York.

FOR SALE.

For Sale—Factory Building and property, finest factory site in state of Iowa on the Mississippi River. In heart of city of 25,000. Shipping facilities first class. Tracks right on property. Will sell cheap to satisfy two family estates. Address X, care The Hub, 24 Murray St., New York.

PATENTS.

Patents—H. W. T. Jenner, patent attorney and mechanical expert, 608 F St., Washington, D. C. Established 1883. I make a free examination and report if a patent can be had and exactly what it will cost. Send for circular.

Timken Roller Bearings

not only reduce friction to a minimum, but enables two horses to do the work of four in actual hauling.

They can be fitted to all classes and styles of carriages and wagons, adding a selling value to them. And this live dealers know.

TIMKEN ROLLER BEARINGS

require little or no adjustment—are easily gotten at—are simple and fool-proof, requiring oiling but once a month and are sold under a two years' guarantee.

These are a few of the reasons why

TIMKEN ROLLER BEARINGS

are being used by Ninety odd (90) per cent of all the makers of high grade American Automobiles in part or throughout their cars.

If you are not using them, write us for REASONS why you should.

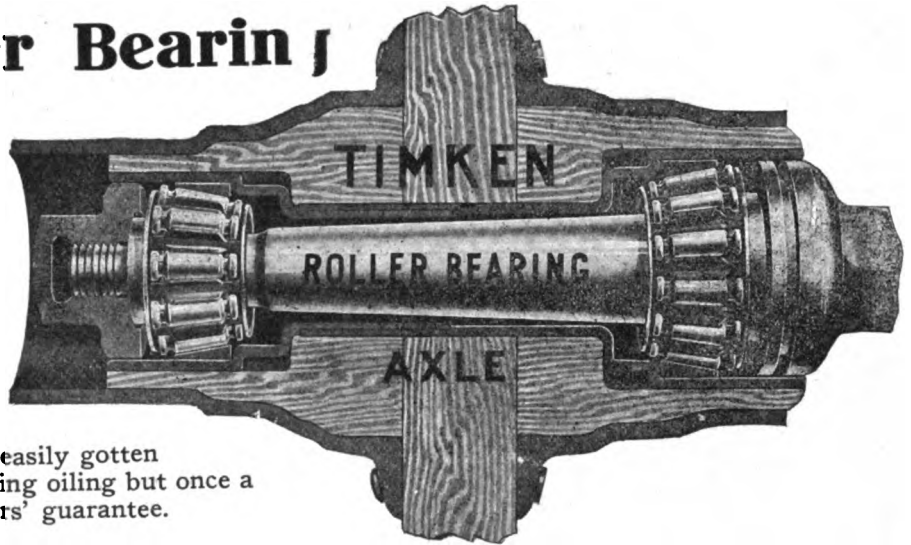

Branches
10 E. 31st Street, New York
429 Wabash Ave., Chicago, Ill.

THE TIMKEN ROLLER BEARING CO. Canton, Ohio.

Carriage Mechanics

Desiring to improve their present Condition should attend the

TECHNICAL SCHOOL

FOR

Carriage Draftsmen and Mechanics

SUPPORTED BY THE

Carriage Builders' National Ass'n.

The object of the School is to teach men to design vehicles and make working drawings, and to otherwise facilitate their work in the shop. Only those men employed in carriage or automobile building or their accessory trades are admitted to its privileges.

The classes are conducted in three divisions, viz.: Corresponding, Day, and Evening. The former is open during the entire year, while the day and evening classes are in session only from October 1st to April 1st.

The tuition is moderate.

For prospectus and full particulars, write to the instructor,

ANDREW F. JOHNSON,

18 West Forty-fourth St.,

NEW YORK CITY.

A \$100 Typewriter for 17 Cents a Day!

Please read the headline over again. Then its tremendous significance will dawn upon you.

An Oliver Typewriter—the standard visible writer—the \$100 machine—the most highly perfected typewriter on the market—yours for 17 cents a day.

The typewriter whose conquest of the commercial world is a matter of business history—yours for 17 cents a day.

The typewriter that is equipped with scores of such conveniences as "The Balance Shift"—"The Ruling Device"—"The Double Release"—"The Locomotive Base"—"The Automatic Spacer"—"The Automatic Tabulator"—"The Disappearing Indicator"—"The Adjustable Paper Fingers"—"The Scientific Condensed Keyboard"—all

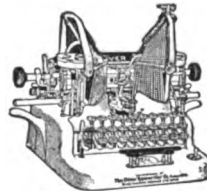

Yours for 17 Cents a Day!

We announced this new sales plan recently, just to feel the pulse of the people. Simply a small cash payment—then 17 cents a day. That is the plan in a nutshell.

The result has been such a deluge of applications for machines that we are simply astounded. Demands come from people of all classes, all ages, all occupations. The majority of inquiries has come from people of known financial standing who were attracted by the novelty of the proposition. An impressive demonstration of the immense popularity of the Oliver Typewriter. A startling confirmation of our belief that the Era of Universal Typewriting is at hand.

A Quarter of a Million
People are Making
Money With

The OLIVER Typewriter

THE STANDARD VISIBLE TYPEWRITER

The Oliver Typewriter is a money-maker, right from the word "go." So easy to run that beginners soon get in the "expert" class. Earn as you learn. Let the machine pay the 17 cents a day—and all above that is yours.

Wherever you are, there's work to be done and money to be made by using the Oliver. The business world is calling for Oliver operators. There are not enough to supply the demand. Their salaries are considerably above those of many classes of workers.

Write for further details of our easy offer and a free copy of the new Oliver catalog. Address

The Oliver Typewriter Company
310 BROADWAY
NEW YORK CITY

Please mention "The Hub" when you write.

HOTEL CUMBERLAND

NEW YORK

Southwest Cor. Broadway at Fifty-fourth St.

Near 50th St. Subway Station, 53d St. Elevated and all Surface Lines.



Headquarters for
Carriage and
Automobile Trade

Ideal Location, Near Theatres,
Shops and Central Park.

NEW AND FIREPROOF
STRICTLY FIRST-CLASS

RATES REASONABLE
All Hardwood Floors and
Oriental Rugs.

Ten Minutes Walk to
Twenty Theatres.

Transient Rates, \$2.50 with Bath, and up.

Excellent Restaurant. Prices Moderate.

SEND FOR BOOKLET.

HARRY P. STIMSON,
Formerly with Hotel Imperial.

R. J. BINGHAM,
Formerly with Hotel Woodward.



Richard Eccles Co., Auburn N. Y.

Manufacturers of

Orgings: arriage, Wagon, Automobile, Special

Send for Catalogue.

TRUCK BUILDERS

If you only realized the inestimable value of roller bearing fifth wheels on trucks, vans, delivery wagons and all other medium and heavy vehicles, no job would leave your shop without

Roller Bearing Fifth Wheels

WHY? The adjustment is perfect. No oil or grease required. Almost indestructible. Will outwear any vehicle. Saves horseflesh and prolongs life of vehicle. Ask your jobber for the celebrated

NIELSON OR KING

Let us send you Catalogue and Price List.

American Roller Bearing Fifth Wheel Co.

745 THIRD AVE., BROOKLYN, N. Y.

INDEX TO ADVERTISEMENTS.

| | |
|------------------------------------------------|-----------|
| American Ball Bearing Co., The | 2nd Cover |
| American Roller Bearing Fifth Wheel Co. | 10 |
| Bradley & Son, C. C. | 4th cover |
| Cargill Company | 4 |
| Columbus Bolt Works | 4th cover |
| Consolidated Rubber Tire Co | 6 |
| Crane & MacMahon | 2d cover |
| Devoe, F. W., & Reynolds Co., C. T. | 3d cover |
| Eberly & Orris Mfg. Co. | 3d cover |
| Eccles Co., Richard | 10 |
| English & Mersick Co., The | 2 |
| Gifford & Son, John A. | 14 |
| Goodrich Co., B. F., The | 5 |
| Hoopes Bro. & Darlington, Inc. | 2d cover |
| Indianapolis Dash Co. | 14 |
| Jones & Co., Phineas | 11 |
| Keystone Forging Co. | 11 |
| LeCompte Mfg. Co. | 13 |
| Lounsberry & Sons, G. H. | 3d cover |
| Masury & Son, John W. | 2 |
| McKinnon Dash Co. | 4th cover |
| Moore & Co., Benjamin | 3 |
| Moller & Schuman Co. | 3 |
| Mott Wheel Works | 3rd cover |
| Murphy Varnish Co. | 1 |
| National Spring and Wire Co. | 11 |
| Porter, H. K. | 10 |
| Russell, Burdsall & Ward Bolt and Nut Co. | 3d cover |
| Schubert Bros. Gear Co. ... | 14 |
| Smith & Co., Edw. | 3 |
| Spring Perch Co. | 11 |
| Standard Oil Cloth Co. | 14 |
| Standard Wheel Co. | 1 |
| Timken Roller Bearing Co. | 9 |
| Uebelmesser Co., Charles R. | 12 |
| Valentine & Company | 3 |
| West Tire Setter Co. | 14 |
| Wilcox Mfg. Co., D. | 11 |
| Willey Co., C. A. | 2 |
| Woodman, Joel H. | 12 |

Please mention "The Hub" when you write.

FIFTH WHEELS—FORGINGS

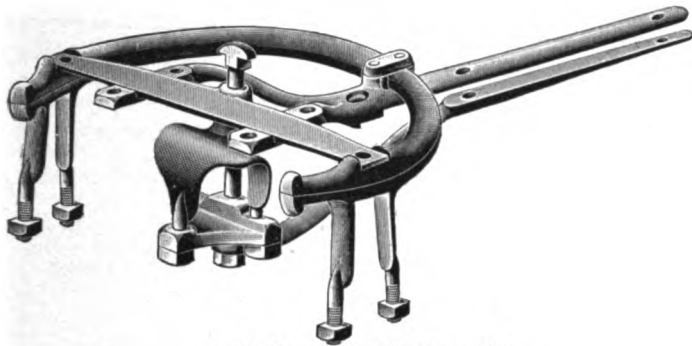

1908 Single-Reach Gear Set.

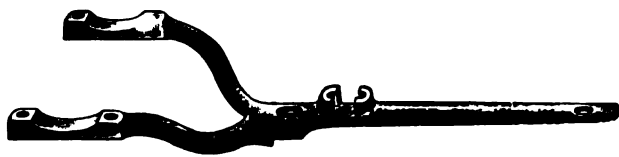

Detachable Fork Perch Connection Used in 1908 Gear Set.

Greatest Line on Earth

WHEN ORDERING GEAR SETS BE SURE TO GET THE GENUINE

Wilcox Rear King-Bolt Gear Sets

WRITE US FOR FULL PARTICULARS

THE D. WILCOX MANUFACTURING CO.

MECHANICSBURG, PENNSYLVANIA

Our Carriage or Spring Edge Cushion Frame



Is not an Experiment, but has been tried and stands the test.
We would like to quote you prices.
NATIONAL SPRING and WIRE CO.,
ALBION, MICH., and ST. CATHARINES, ONT., CAN.

Jones Wheels

BEST ON EARTH

KANTSAMORE

Phineas Jones & Co.

Newark, N. J.



PATENTED DEC. 3, 1901

THE STANDARD BODY LOOP

NONE LIKE IT NONE EQUAL TO IT

A popular body loop, unequalled by any on the market.
For further information, address

The KEYSTONE FORGING CO., Northumberland, Pa

CARRIAGE SPRINGS

OF EVERY STYLE AND PAT-
TERN TO ORDER

Also Curtain Rollers and Concealed Hinges
EXCLUSIVELY FIRST-CLASS WORK
THE BEST THAT CAN BE MADE

SPRING PERCH CO.

BRIDGEPORT, CONN.

Please mention "The Hub" when you write.



Painters and Decorators Save Time, Labor and Money, using the

Uebelmesser Stripping and Stencil Wheel

With this simple, clean and rapid-action tool the most ordinary decorator can do the finest stripping and stencil work and produce a bigger day's work with less labor than by the old fashioned method. Complete directions are furnished with each tool. They are as simple as the tool itself.

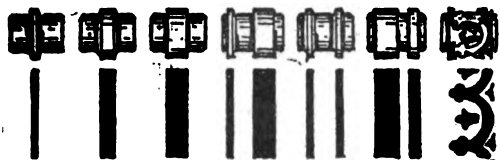

Just a few of the many designs that can be produced with the Uebelmesser Painters' and Decorators' Tool. (The designs shown above are reduced in size)

Complete Outfit consisting of Machine, 10 Plain and 10 Ornamental Wheels, only... **\$5.50**

LIBERAL DISCOUNT TO THE TRADE

Manufactured by

Charles R. Uebelmesser Company
Bayside, New York, N. Y.

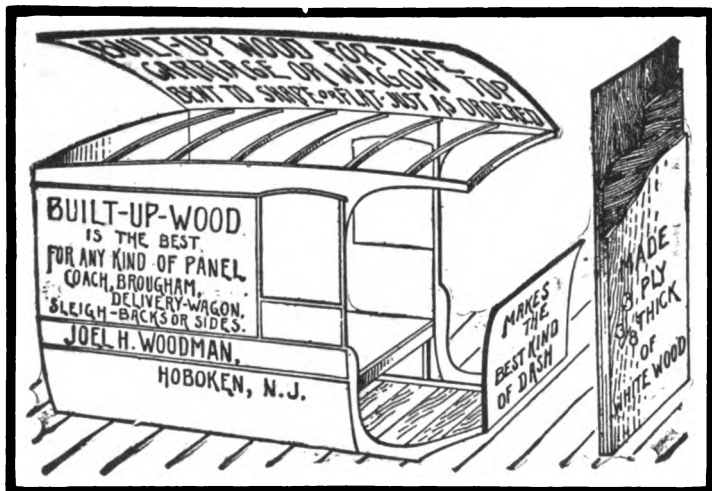

Journal for the Carriage and Automobile Trade

The Hub

Published Monthly at Two Dollars per Year

Advertisements Classified

The following list includes advertisers in THE HUB. Each advertiser is entitled to name under one heading only. An extra charge for name under more than one heading.

Automobile Parts.

LeCompte Mfg. Co., New York City.

Axles, Etc.

American Ball Bearing Co., Cleveland, Ohio.

Timken Roller Bearing Co., Canton, Ohio.

Bodies, Seats, Etc.

Woodman, Joel H., Hoboken, New Jersey.

Bolts and Nuts.

Columbus Bolt Works, Columbus, Ohio.

Russell, Burdall & Ward Bolt and Nut Co., Port Chester, N. Y.

Carriage Cloths.

Wiese & Co., Wm., New York City.

Carriage Forgings.

Eccles Co., Richard, Auburn, N. Y.
Keystone Forging Co., Northumberland, Pa.

Carriage Hardware.

Gifford & Son, John A., New York.

Carriage Goods.

English & Mersick Co., New Haven, Conn.
Gifford & Son, John A., New York.
Herbrand Co., The, Fremont, O.

Dashes, Fenders, Rails, Etc.

McKinnon Dash Co., Buffalo, N. Y.

Fifth Wheels.

American Roller Bearing Fifth Wheel Co., Brooklyn, N. Y.
Wilcox Mfg. Co., D., Mechanicsburg, Pa.

Jacks.

Hankinson, J. V., Franklin, O.

Lamps.

Gifford & Son, John A., New York.
Stevens & Sackett Co., New Haven, Conn.

Machinery and Tools.

Barnes Co., W. F. & John, Rockford, Ill.

Porter, H. K., Everett, Mass.
West Tire Setter Co., Rochester, N. Y.

Miscellaneous.

Standard Oil Cloth Co., New York.

Uebelmesser Co., Charles R. Bayside, New York, N. Y.

Rubber Tires.

Consolidated Rubber Tire Co., New York City.

Goodrich Co., B. F., Akron, O.

Goodyear Tire and Rubber Co., Akron, O.

Swinehart Climber Tire & Rubber Co., Akron, O.

Shaft Couplings and Anti-Rattlers.

Bradley & Son, C. C., Syracuse, N. Y.

Eccles Co., Richard, Auburn, N. Y.

Metal Stamping Co., New York City.

Springs and Gears.

Akron-Selle Gear Co., Akron, Ohio.

National Spring and Wire Co., Albion, Mich.

Spring Perch Co., Bridgeport, Conn.

Trimming Materials.

Stevens & Sackett Co., New Haven, Conn.

Varnishes, Paints and Japans.

Devos, F. W., and C. T. Raynolds Co., New York City.

Harland & Son, Wm., London and New York.

Masury & Son, John W., New York and Chicago.

Moller & Schumann, Brooklyn, N. Y.

Moore & Co., Benj., Cleveland, Ohio.

Murphy Varnish Co., Newark, N. J.

Pierce Co., F. O., New York.

Smith & Co., Edw., New York.

Valentine & Co., New York, Chicago, Boston, Paris.

Wiley Co., C. A., Hunter's Point, New York City.

Wheels.

Crane & MacMahon, New York.

Gifford & Son, John A., New York.

Hoopes Bro. & Darlington, West Chester, Pa.

Jones & Co., Phineas, Newark, N. J.

Standard Wheel Co., Terre Haute, Ind.

Wheel Stock, Bent Wood, Etc.

Crane & MacMahon, New York.

Contractors

Automobile Parts

PLAIN
FINISHED
MACHINED

CASTINGS

B^{Brass}_{ronze} **A**^{luminum}_{utomobile} **BRONZE**

MANGANESE BRONZE

POPE'S ISLAND

Non-corrosive Metal, Silver and Gold; Best known metal

HAND CLOSE PLATING

Seven Colors, guaranteed to last the life of car, carriage or harness.

ELECTRO PLATING

Black, White, Gold, Silver, Nickel, Brass or Gunmetal

Contracts made with car manufacturers

Horse Bits

"If it's a bit, we have it"

LeCompte Mfg. Co.

E. A. Whitehouse Mfg. Co.

} Inc.

OFFICE
110 Chambers St., New York

FACTORY AND FOUNDRY
44-50 Elm St., Newark, N. J.

Write for a pair of our
Cast Metal Silver or Gold
Horse Bit Cuff Buttons FREE

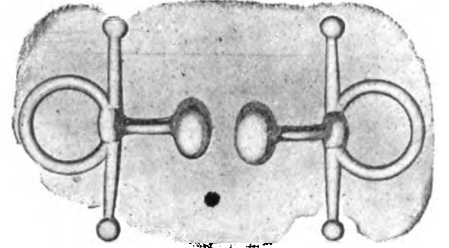

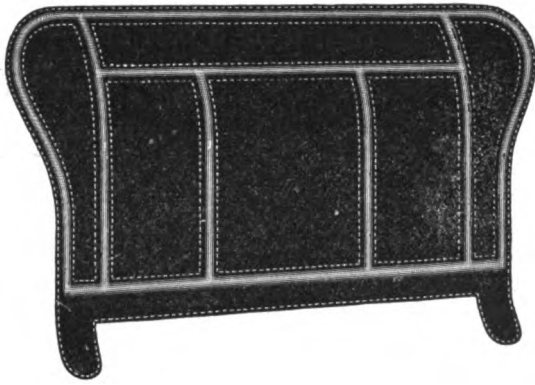

HIGH GRADE Dashes and Fenders

THE INDIANAPOLIS DASH CO.

INDIANAPOLIS

INDIANA

ESTABLISHED 1886.

Correspondence School of Carriage and Motor Carriage Drafting

A thorough, practical tuition is given through this correspondence school. The theory and practice of construction, bookkeeping, perspective. Many men now hold good positions through taking the courses of instruction.

Principal, THOS. MATTISON,
Hillside Avenue, Bitterne Park,
Southampton, England.

Author of "The Coach Body Makers' Guide," \$3.00; a practical treatise on "The Suspension of Carriages," "Bookkeeping," and other carriage building works.



MERITAS
STANDARD
OIL CLOTH
O.T.C.
COMPANY

Cover a carriage top with MERITAS enameled oil cloth—cover another with any other kind—follow them up and see how long the tops last.

MERITAS will be in good condition long after the other has been caked, cracked and weather-killed. Try it—then stick to the kind that lasts the longest.

Look on the back of the goods for our trademark.

See Your Jobber.

Standard Oil Cloth Co.
320 Broadway, New York

VEHICLES AND GEARS IN THE WHITE

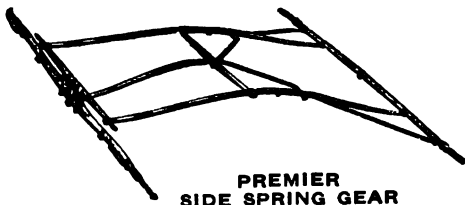

PREMIER
SIDE SPRING GEAR

We manufacture a full line of Carriage and Wagon bodies in the white; also Limousine, Taxicab, Touring Car and Roadster Bodies for automobiles in metal. Fifty styles of gears for Carriages and Wagons; also seats, trimmings and tops of all kinds.

Write to us for particulars.

Schubert Bros. Gear Company
ONEIDA, NEW YORK.

Please mention "The Hub" when you write.

The WEST Hydraulic Tire Setter WILL CUT DOWN EXPENSE

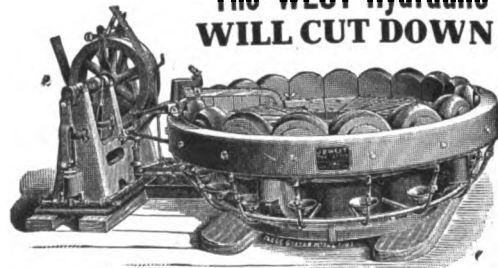

Tires set cold in one minute. This machine saves time—does the work better and quicker, does away with burned streaks. Only necessary to measure one wheel in a lot. Does not char the rim and

thus make the tire loosen prematurely. Saves re-sandpapering of wheels.

This machine is now increasing the profits of many manufacturers. Send for catalog and read about it.

WEST TIRE SETTER CO., ROCHESTER, NEW YORK

F. W. DEVOE & C. T. RAYNOLDS CO.

101 and 103 FULTON STREET, NEW YORK

Manufacturers of

F. W. DEVOE & CO'S {
COACH COLORS
VARNISHES
BRUSHES
SPECIALTIES

C. T. RAYNOLDS & CO'S {
COACH COLORS
VARNISHES
BRUSHES
SPECIALTIES

FOR PAINTERS, ARTISTS AND DECORATORS

All the brands and specialties of F. W. Devoe & Co. and C. T. Raynolds & Co. will be maintained separately as heretofore.

WIRE WHEELS TO FIT EMPIRE BALL BEARING AXLES

Quality Unsurpassed

Write Today

The Mott Wheel Works
UTICA, N. Y.

Brazil Leather

FOR AUTO BUGGY TOPS

SEAT AND BACK SPRINGS,
COTTON, NAILS, WADDING,
MOSS, TACKS, WASHERS,
HAIR, BUTTONS, REEDS,
REED MOULDING,
CLINCH BUTTONS

G. H. Lounsbery & Sons
Cincinnati, Ohio

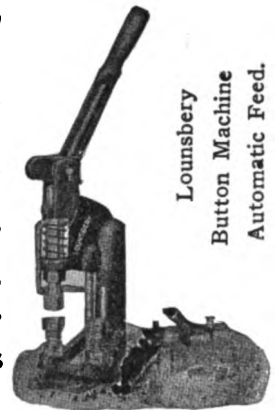

Lounsbery
Button Machine
Automatic Feed.

BOLTS Rivets, Carriage Makers' Washers
and Burrs for all kinds of Vehicles
Russell, Burdsall & Ward Bolt and Nut Co.
Main Works, PORT CHESTER, N. Y. Branch at Rock Falls, Ill.

Time Has Told the Story!

Service and satisfaction always follow our rolling stock

WHEELS

ALL KINDS—BEST QUALITY

Also RIMS and SPOKES

The Eberly & Orris Mfg. Co.
MECHANICSBURG, PA.

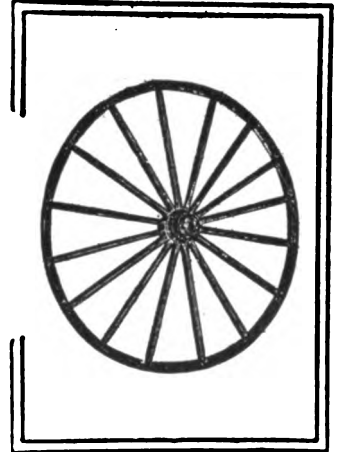

Hoopes Bro. & Darlington Inc.

West Chester, Penna., U. S. A.

SARVEN
STAR or KENNY
 Sweet Concealed Band
WOOD HUB
WARNER

WHEELS

HEAVY and LIGHT
 for
CARRIAGES
WAGONS and
TRUCKS

IF YOU WANT THE BEST TRY OURS

The Output of Complete FRONT AND REAR AUTOMOBILE AXLES of this Plant Exceeds the Capacity of All Competition Combined.

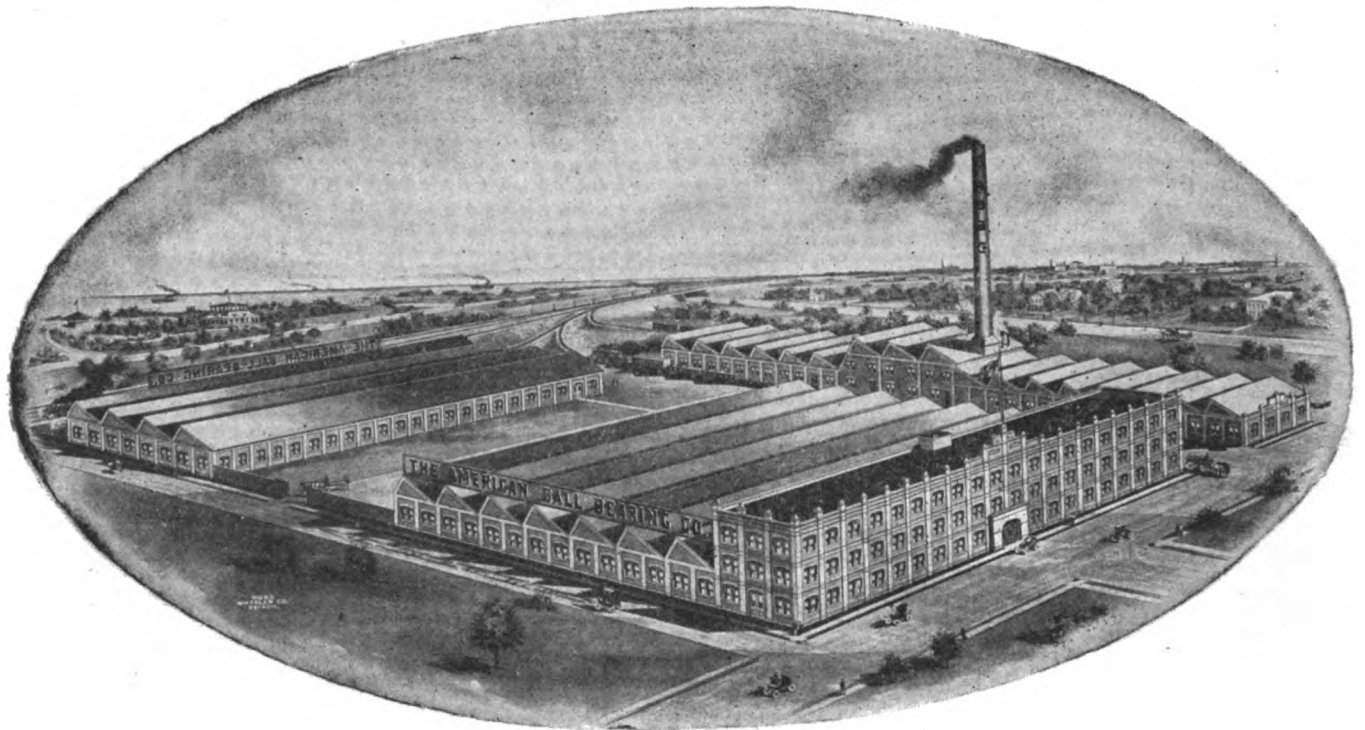

The American Ball-Bearing Co.,

L. S. & M. S. R'y and Edgewater Park.

CLEVELAND, OHIO, U. S. A.



CRANE & MACMAHON, (INCORPORATED)

8-10 Bridge St., NEW YORK CITY, U. S. A.

Sole Manufacturers and Exporters of the

HICKORY NUT,  ACORN,  and STAR  BRANDS OF

Carriage, Wagon and Automobile Wood Stock

FACTORIES:

ST. MARYS, OHIO. RICHMOND, VA.

For Export Prices apply to the New York office.

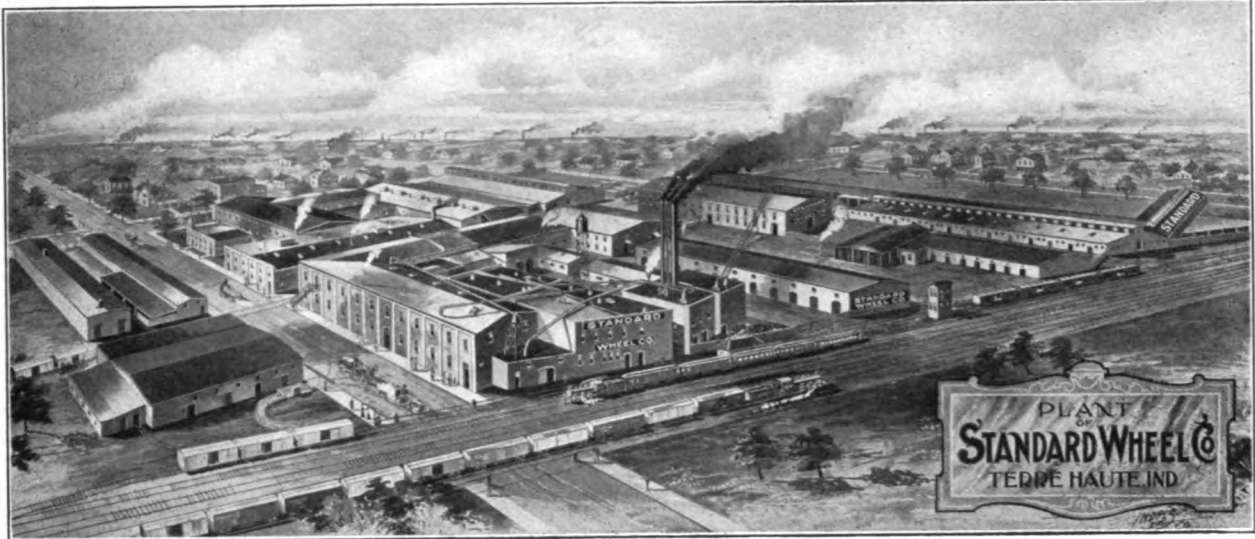

VEHICLE WHEELS AND WHEEL MATERIAL

Three Separate Departments [Light Carriage and Buggy Wheels
Heavy Express Wagon and Truck Wheels
Automobile Wheels

OUR GRADES ARE UNEXCELLED

WRITE FOR LIST.

Terre Haute, Ind. STANDARD WHEEL CO. Terre Haute, Ind

Our Carriage or Spring Edge Cushion Frame



Is not an Experiment, but has been tried and stands the test.
We would like to quote you prices.
NATIONAL SPRING and WIRE CO.,
ALBION, MICH., and ST. CATHARINES, ONT., CAN.

Jones Wheels

BEST ON EARTH

KANTSAMORE

Phineas Jones & Co.

Newark, N. J.



PATENTED DEC. 3, 1901

THE STANDARD BODY LOOP

NONE LIKE IT NONE EQUAL TO IT
A popular body loop, unequaled by any on the market.
For further information, address

The KEYSTONE FORGING CO., Northumberland, Pa

CARRIAGE SPRINGS

OF EVERY STYLE AND PAT-
TERN TO ORDER

Also Certain Rollers and Concealed Hinges
EXCLUSIVELY FIRST-CLASS WORK
THE BEST THAT CAN BE MADE

SPRING PERCH CO.

BRIDGEPORT, CONN.

Please mention "The Hub" when you write.

JOHN W. MASURY & SON

Originators of

Superfine Coach and Automobile Colors

Acknowledged the Standard for Fifty Years

AND MANUFACTURERS OF

Fine Carriage and Automobile Varnishes

New York,

Chicago,

Minneapolis,

Kansas City

WILLEY'S COLORS

The RECOGNIZED STANDARD



C. A. WILLEY CO.

COLORS GRINDERS

and Manufacturers of Specialties in

CARRIAGE, AUTOMOBILE AND CAR

PAINTS

COLORS, VARNISHES, ETC.

HUNTER'S POINT, NEW YORK CITY

THE STANDARD Auto Door Locks FOR NINETEEN TEN

No. 999 Security Hook Lock
for Touring Cars.

No. 25 Security Hook Lock with
complete lever control
for Touring Cars.

No. 39 Rotary Lever Lock for
Limousines and other
closed vehicles.

Test them out NOW for the
coming season. : : : :

English & Mersick Co.

New Haven, Conn.

WHAT'S IN A NAME?

THIS: Durability
 Permanence of lustre
 Paleness and Transparency
 Depth and roundness of finish
 Working and flowing qualities
 Freedom from blooming and clouding

WHAT'S THE NAME?

VANADIUM VARNISH

WHAT GIVES THE NAME CHARACTER?

THIS: Seventy-five years of successful accomplishment and approval

HOW SHALL IT BE KNOWN?

By the trade mark that is known around the world

Trade **VALENTINES** Mark
VAR N I S H E S

VALENTINE & COMPANY

New York Chicago Boston Toronto Paris Amsterdam

83 Years' Experience in Every Can



Edward Smith & Co.

CARRIAGE VARNISHES

Everything from the Bare Wood to the Finishing Coat.

CHICAGO

NEW YORK

KIMBLE'S FAMOUS GEAR WOODS

still represent the highest standard of excellence and quality. True to our motto our line wins the approval of all vehicle builders.

WHAT CAN WE DO FOR YOU ?

ANDREW KIMBLE
 ZANESVILLE, O.

RUB ————— RUB ————— RUB

THAT'S THE EXPERIENCE SOME PAINTERS HAVE WITH A POOR RUBBING VARNISH. THEY RUB TILL THEIR HEART ACHES ONLY TO HAVE THE VARNISH SWEAT, OR ROLL UP UNDER THE PAD

XX Diamond Rubbing and Hard and Quick Drying Rubbing "A"

DRY HARD TO RUB IN TWO DAYS, WITHOUT SWEATING, ARE TOUGH AND THE BEST FOUNDATION FOR FINISHING COATS.

MADE BY **MOLLER & SCHUMANN CO.**

MARCY AND FLUSHING AVES.,

BROOKLYN, N. Y.

Please mention "The Hub" when you write.

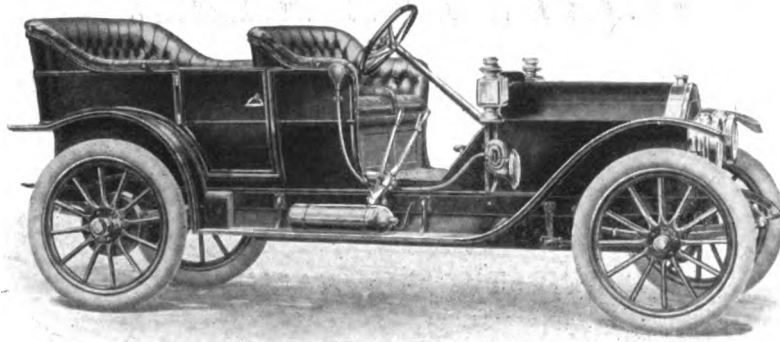

If you are to issue a catalog this Fall, why not get it from headquarters? The reputation of **The Cargill Company** for high class vehicle and auto work is unsurpassed by that of any other house in America. Write in your specifications and we will do the rest.

DESIGNING, ENGRAVING, PRINTING, BINDING UNDER ONE ROOF

The Cargill Company

Grand Rapids Engraving Company
Grand Rapids, Michigan

American Harness and Saddlery Directory

FOR 1910 IS NOW
ON SALE

It is the most accurate
and complete edition
that has been published

Trade News
Publishing Company

24-26 Murray St., New York

THE list of the **WHOLESALE** and **JOBGING TRADE** is so arranged as to make it convenient to separate the association members from those not so recognized.

The **RETAIL HARNESS MAKERS** of the United States and Canada comprise the principal part of the Directory, arranged by State, Town and County, and in the large cities, the street and number is given. Those rating (approximately) over \$1,000 are marked.

A list of **HARNESS DEALERS** as distinguished from retail harness manufacturers, is also given. The value of this list to those who solicit the vehicle, implement, hardware and department stores will be readily appreciated.

THE BUYER'S GUIDE is a valuable as well as unique feature. It contains an alphabetical classification of all the many and various articles made to sell to the trade, and the names of those making the various articles.

A list is also published of Export Commission Merchants, giving the class of merchandise they handle.

**THE PRICE OF THE DI-
RECTORY IS \$4.00.
PAYABLE IN ADVANCE.**

GOODRICH

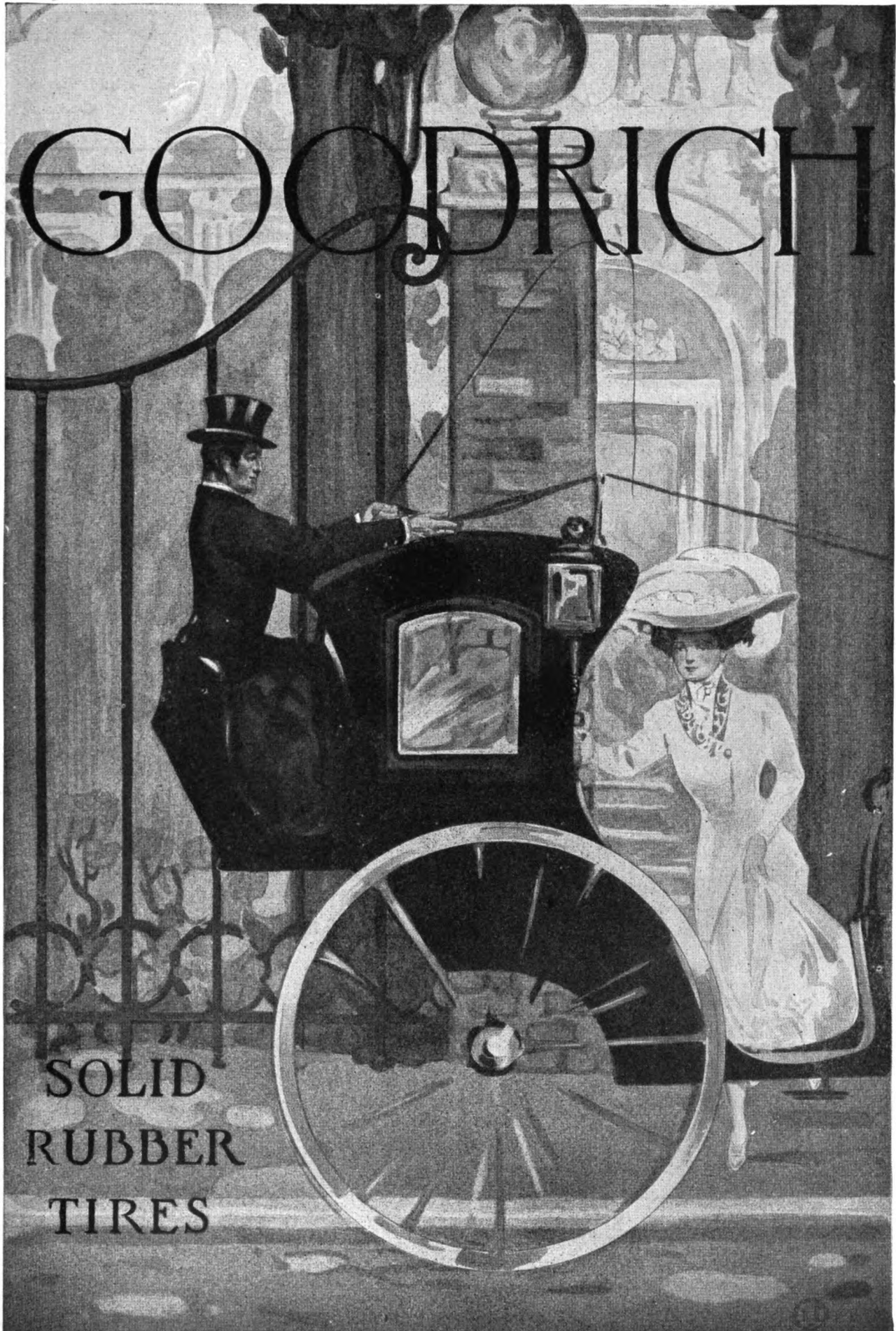

SOLID
RUBBER
TIRES

Kelly-Springfield Automobile Tires

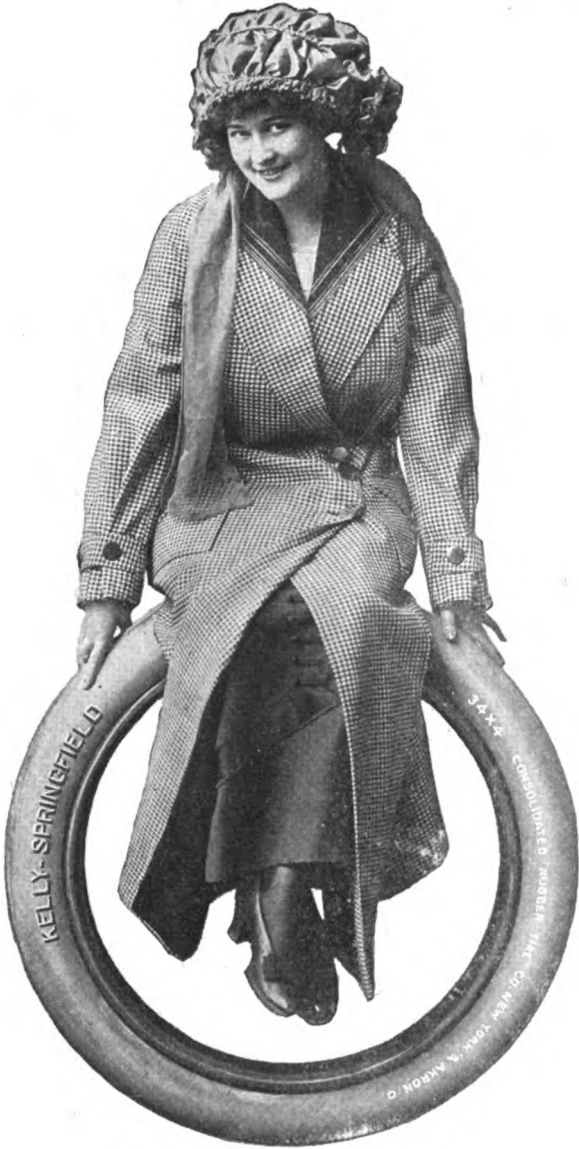

There is no getting around the fact that service in an automobile tire does depend on the quality of the tire itself. The quality of the Kelly-Springfield Automobile Tire is the quality of the now world-famous Kelly-Springfield Vehicle Tire.

"Thanks for providing me with tires which allow us to stay in the car and ride rather than to stay on the road and pump."
PHILIP A. ROLLINS,
32 Nassau Street, New York

Consolidated Rubber Tire Company

20 Vesey St., New York

Branch Offices in
New York, Chicago, Philadelphia, Boston, St. Louis,
Detroit, Cincinnati, San Francisco and Akron, O.

Carriage Mechanics

Desiring to improve their present
Condition should attend the

TECHNICAL SCHOOL

FOR

Carriage Draftsmen and Mechanics

SUPPORTED BY THE

Carriage Builders' National Ass'n.

The object of the School is to teach men to design vehicles and make working drawings, and to otherwise facilitate their work in the shop. Only those men employed in carriage or automobile building or their accessory trades are admitted to its privileges.

The classes are conducted in three divisions, viz.: Corresponding, Day, and Evening. The former is open during the entire year, while the day and evening classes are in session only from October 1st to April 1st.

The tuition is moderate.

For prospectus and full particulars, write to the instructor,

ANDREW F. JOHNSON,

18 West Forty-fourth St.,

NEW YORK CITY.

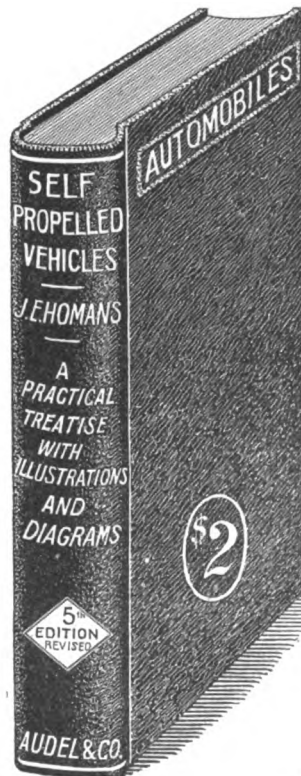

"Self-Propelled Vehicles"

Fifth Edition, Revised.

A practical treatise on the theory, construction, operation, care and management of all kinds of Automobiles.

By

JAMES E. HOMANS, A.M.

Contains 608 pages and upwards of 500 illustrations and diagrams, giving the essential details of construction and many important points on the successful operation of the various types of motor carriages driven by steam, gasoline and electricity.

This work is now the accepted standard, explaining the principles of construction and operation in a clear and helpful way. This book will be sent postpaid to any address in the United States, Mexico or Canada upon receipt of \$2.00.

Address

TRADE NEWS PUBLISHING COMPANY

24 Murray Street, New York

The Hub

Copyright, 1910, by the Trade News Publishing Co. of New York.

Entered in the New York Post Office as Second-class Matter.

Vol. LII.

AUGUST, 1910.

No. 5.

THE TRADE NEWS PUBLISHING CO. OF N. Y. Publishers of THE HUB

J. H. WRIGHT, *President.* G. A. TANNER, *Secretary and Treasurer.*
24-26 MURRAY STREET, NEW YORK.

JACOB H. KLEIN, *Technical Editor.*

Other Publications of Trade News Publishing Co.:

HARNESS (monthly)per year, \$1.00
AMERICAN HARNESS AND SADDLERY
DIRECTORY (annual)per copy, \$4.00

THE HUB is published monthly in the interest of employers and workmen connected with the manufacture of Carriages, Wagons, Sleighs, Automobiles and the Accessory trades, and also in the interest of Dealers.

Subscription price for the United States, Mexico, Cuba, Porto Rico, Guam the Philippines, and the Hawaiian Islands, \$2.00, Canada, \$2.50, payable strictly in advance. Single copies, 25 cents. Remittances at risk of subscriber, unless by registered letter, or by draft, check, express or post-office order, payable to the order of TRADE NEWS PUBLISHING Co.

For advertising rates, apply to the Publishers. Advertisements must be acceptable in every respect. Copy for new advertisements must be received by the 25th of the preceding month, and requests to alter or discontinue advertisements must be received before the 12th day of the preceding month to insure attention in the following number. All communications must be accompanied by the full name and address of writer.

FOREIGN REPRESENTATIVES:

FRANCE.—L. Dupont, publisher of *Le Guide des Carrossiers*, 78 Rue Boissiere, Paris. Subscription price, 15 francs, postpaid.

GERMANY.—Gustave Miesen, Bohn a Rh. Subscription price, 12 marks, postpaid.

ENGLAND.—Thomas Mattison, "Floriana," Hillside Avenue, Bitterne Park, Southampton. Subscription price, 12 shillings, postpaid.

Cackle and Cluck.

Those who speak for the automobile by authority seem to be very much perturbed by the admonitions of the financial philosophers to the public. The advice is to button the pockets and indulge not in silly chasing over the land in part-paid for property. It is intimated that you should buy a motor car as you are supposed to buy a horse-drawn vehicle, because you have a use for it, or it can be afforded for pleasure because there is a surplus that can be applied to its purchase.

The development of the automobile industry has been abnormal. We almost believe the maker would admit it, but not for publication. We never noticed anything abnormal that did not become normal or nothing.

The abnormality seems to be passing now, or it has begun to pass, at least. The readjustment will be very interesting to note. But just now there seems to be a perturbed state of mind not unlike that of the hen who lowers and spreads her wings and clucks loudly for the chicks to run to cover. It indicates alarm. But what is there to be alarmed about?

While the production of cars has been stupendously great, there must also have been vast heaps of them sent

to the scrap pile, so the effective machines cannot, we suppose, be anywhere near as large as statistics tell about.

Those makers who have become hungry at a very late period of the feast, may have but little cake to practice on, owing to the large portions taken by those who got seats at the table early. That is a chance in all scrambles for a good thing.

It looks as if the able journalists were being stam-peded when they talk about the "vicious attacks of alarmists." One resorted to history, even, and went back to nearly the stone age to show the automobile was bound to evolve; and that he was an enemy of his kind who cautioned against buying what couldn't be paid for without debt.

All this will come in the wash. No occasion for alarm. The time of peaceful, legitimate business in the making of motor cars is developing, when \$2,000 will look an extravagant price, while \$175 will not be thought so very cheap for a long-stroke single cylinder machine, which will be in the "Cincinnati Buggy" class, as that phrase was used at one time.

Then those who have become used to gambling profits and will not submit to anything so prosaic as a mere per cent over cost, will be found in the "flying machine game." Same methods, same juicy rake-off, but smaller buying public.

The Doctor is Our Stand-by.

We have always looked with favoring eye on the physician. He has been responsible for more improvements in the vehicle trade than anyone.

He is, and must necessarily be, a hard user of vehicles.

No one ascertains their defects, if they possess any, so soon as he. He thinks as he rides or drives. It is his profession to diagnose, hence why not diagnose what appears to be uncomfortable in his vehicle, and think about what might be a remedy.

The horse-drawn vehicle builder is indebted to the doctor for some of the most improving suggestions, and the patent office is honeycombed with his patented ideas on the subject of vehicles.

The doctor has been buying motor vehicles and his old habits cling to him. He is full of suggestions.

He must have a car that is small, simple, reliable and silent. To attain silence and facility of handling, the power must be moderate; therefore, weight and dimensions must be moderate, too. Reliability goes hand in hand with simplicity, speaking conservatively. Simplicity

is compatible with standard practice of to-day, of course, yet it may be that to-morrow will do markedly better. There is the thought constantly occurring that the two-cycle engine will furnish eventually the right thing for propelling the small car, if not the large one. A single cylinder of this type is practically equal in turning effort to a two-cylinder four-cycle motor, while vibration and number of moving parts may be less than half.

We expect to hear from the doctor more and more, and his quiet, sensible suggestions, the outcome of experience on the road, will have much value.

Get Busy.

A firm, subscribing to *The Hub*, Peters Bros., at Sydney, Australia, writes a letter so much to the point that we feel justified in attracting attention to it in an editorial way, because it is one more of the indications pointing to the trend of the motor car trade we have so often spoken of when all others in the strictly vehicle field seem to have become obsessed by the idea that motor cars, because propelled by the application of a new power, must naturally, and of necessity, find new kinds of buyers developed from quite distinct channels. It is not so, and the proof of the contention will not now long be delayed.

Our friends are "general vehicle manufacturers," and we indicate that it would be well for such motor car and parts makers as are already becoming hungry for trade, mark and digest the contents of our quotation:

"We intend taking an automobile agency. We thought you might put us on to a reliable light freight car to carry up to 2,000 pounds. We have had catalogues from (naming four makers) * * but you may know of other cars, which in your opinion would be suitable for the Australian trade."

Requests like the above are becoming significantly plenty, and show the trend.

Prospect Good.

We believe the carriage builders are to enjoy a fine meeting in Cincinnati. The preparations are complete so far as entertainment goes, and the fat of the land as well as the fullness thereof will be ready to hand out. The Hotel Sinton is one of the country's finest.

We are told the chances for a fine, large exhibition of parts are most promising. There are to be tried, this year, some new features of a restrictive character in the conduct of affairs at the exhibition hall. There is doubt as to the value that can only be resolved by the try-out. The association has been conducted for so many years on the free-for-all, co-operative plan that there must be jolts in changing from low to high gear, especially when the engineers of the new gearing are doctrinaires, with the theory perhaps letter-perfect, but the practical experience all to acquire.

The armory where the exhibits will be displayed is capacious, the ingress and egress are good, but there will be restrictions about nails and other fastenings that it should be well for intending exhibitors to carefully note. We printed them in full in last month's *Hub*. This month

we publish the hotel list and other necessary information that has been supplied by the secretary of the association.

Auto Guaranty.

We see that one large builder of motor cars is recording a guaranty. It is to all intents such as the carriage builder has used for many years. Probably this is only the beginning of a practice that will become general. It is a good practice and should be put to use by all builders of motor cars who have faith in the stability of the work turned out.

Another maker seems to be leading up to the guaranty stage, judging by his advertised statement that he now has enough room to do all the work in daylight working hours, and that the crudities due to night work and haste will be past history.

The evolution of a fad out of the fad state to something stable and trustworthy is always most interesting to observers.

Plane Progress.

The most astounding progress in flying apparatus may be noted between the first and second meeting at Rheims. We do not remember any radically new development that has made such speed in getting out of the experimental stage. The experiments have been lavishly subsidized, and money makes everything move faster.

These air vehicles have also given a new impulse to improvement of the gas engine that has borne fine fruit. It will extend in other directions. The planes of these flyers seem to equal all demands calling for suspension in the air, so it is up to the engine, and that is where we must look for the advances. Already the very optimistic talk about two-passenger flyers, and package and mail carriers as if it were only a question of to-morrow. Who is bold enough to contradict?

Horseless Parade.

The Elks visited Detroit in July, and one of the entertaining features was a parade made up of motors only. It was a highly decorative and decorated affair, many miles in length, and fancy ran riot in the decorations. There were prizes enough to satisfy the emulous in all the forty sections of the parade.

In a sense it was almost the apogee of the gas engine, as it was in evidence in cars on land, boats on water, and flyers in the air.

The Selden Suit.

Another lap in the journey covering the law's delay was scored July 19, when the Federal judge received for filing a tentative decree. Next thing is a bond, or an injunction, then the Court of Appeals, and in time—probably some time after the patent—like Annie Laurie, has "laid down and deed"—it will be before the Supreme Court.

How sharper than a serpent's tooth it is to be a lawyer and not in on a good thing like this.

Vehicle Fashions for August 1910

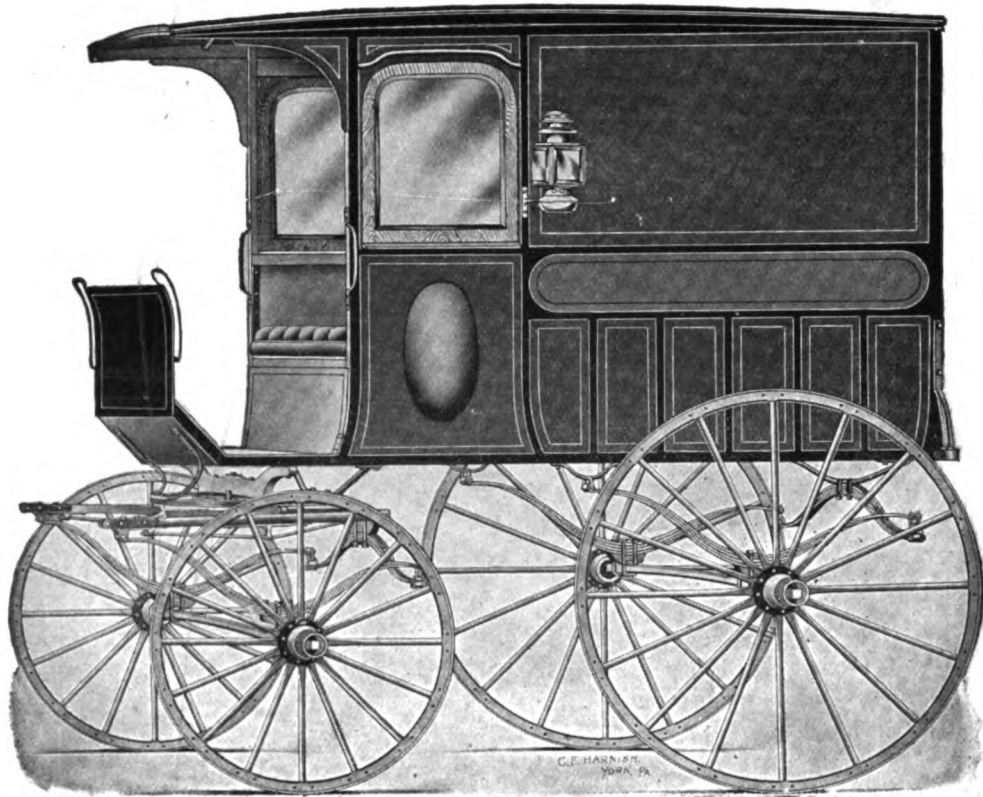

PLATFORM DELIVERY WAGON.
Made by Hoover Wagon Co.

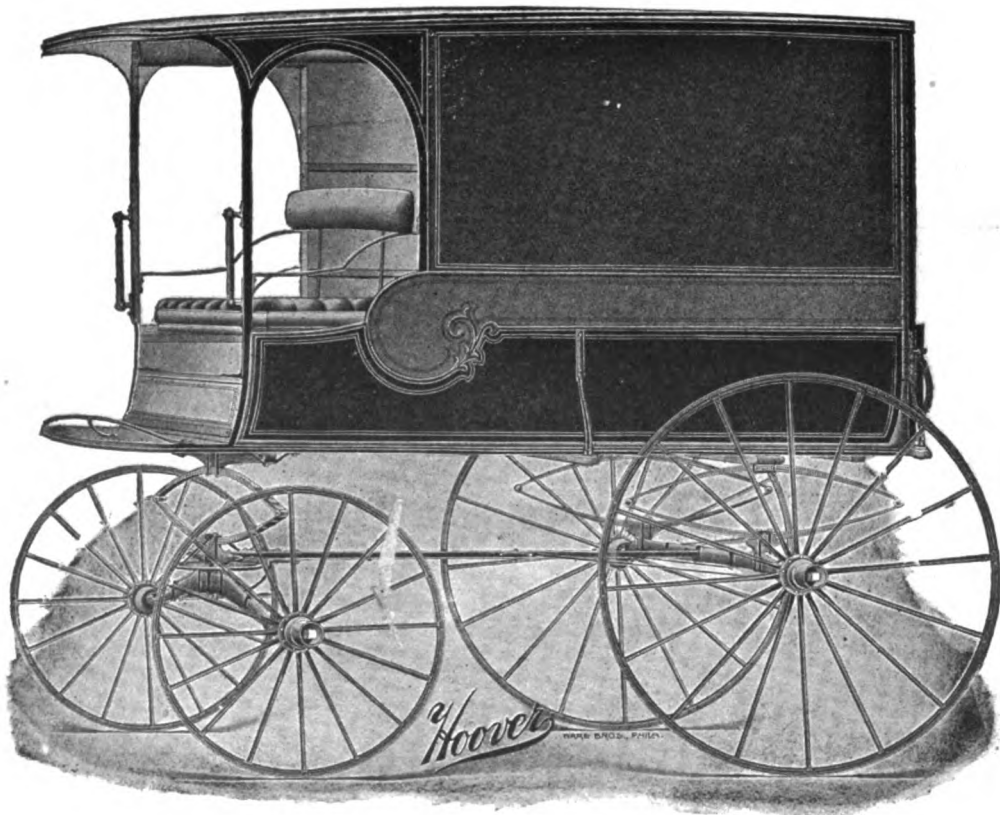

FANCY PANEL TOP DELIVERY WAGON.
Made by Hoover Wagon Co.

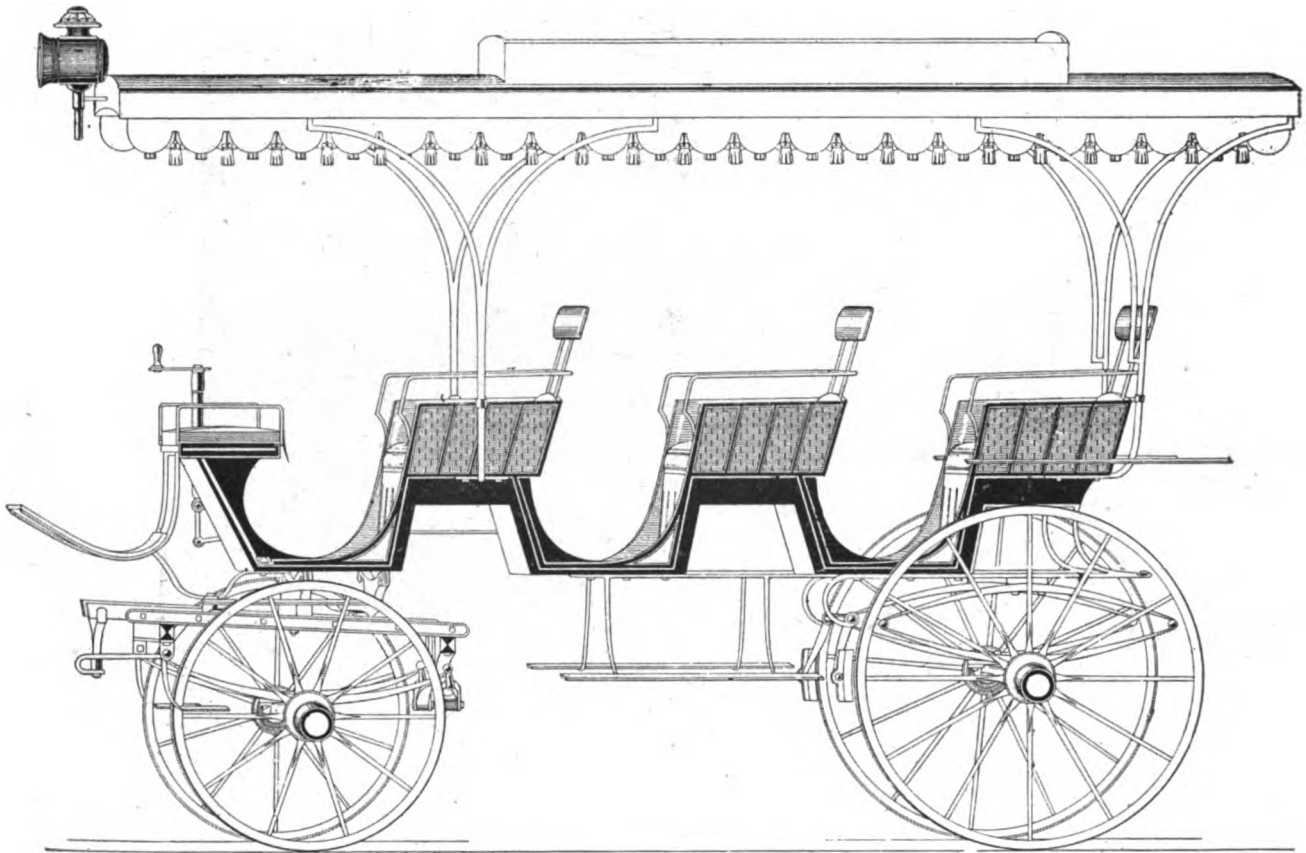

GERMAN SIGHT-SEEING WAGON.
Made in Vienna.

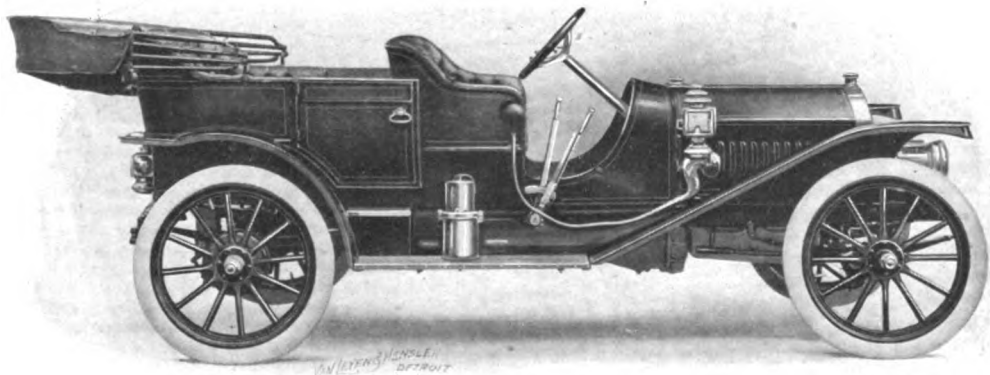

FIVE PASSENGER ALPENA CAR.
Made by Alpena Motor Car Co.

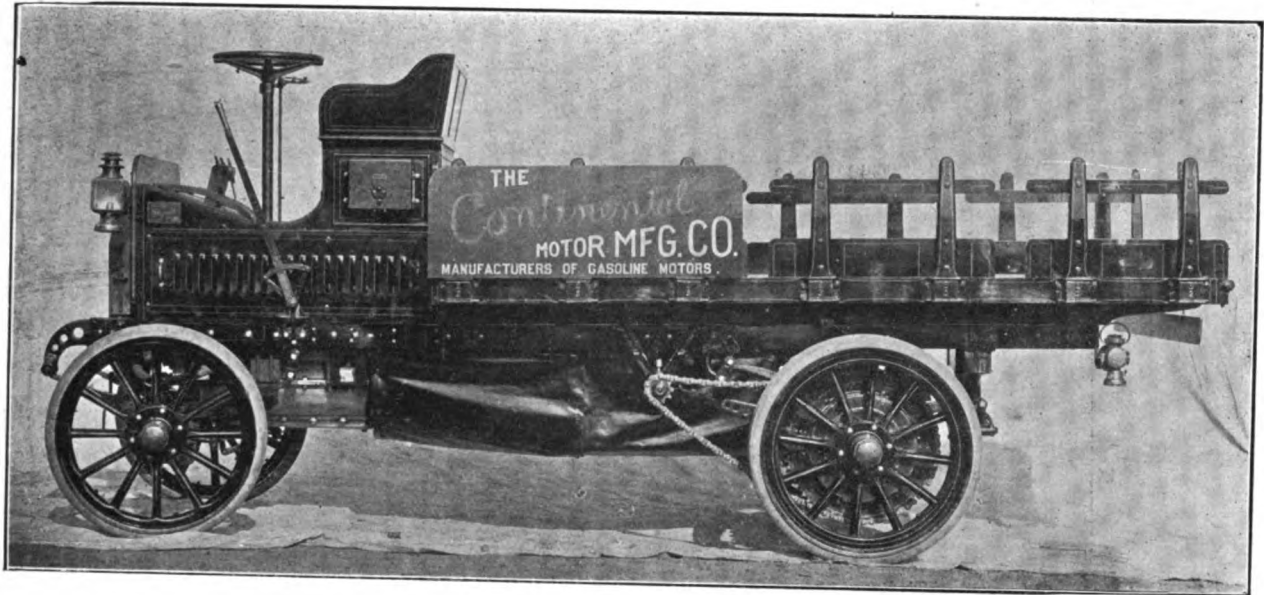

PLYMOUTH MOTOR TRUCK.

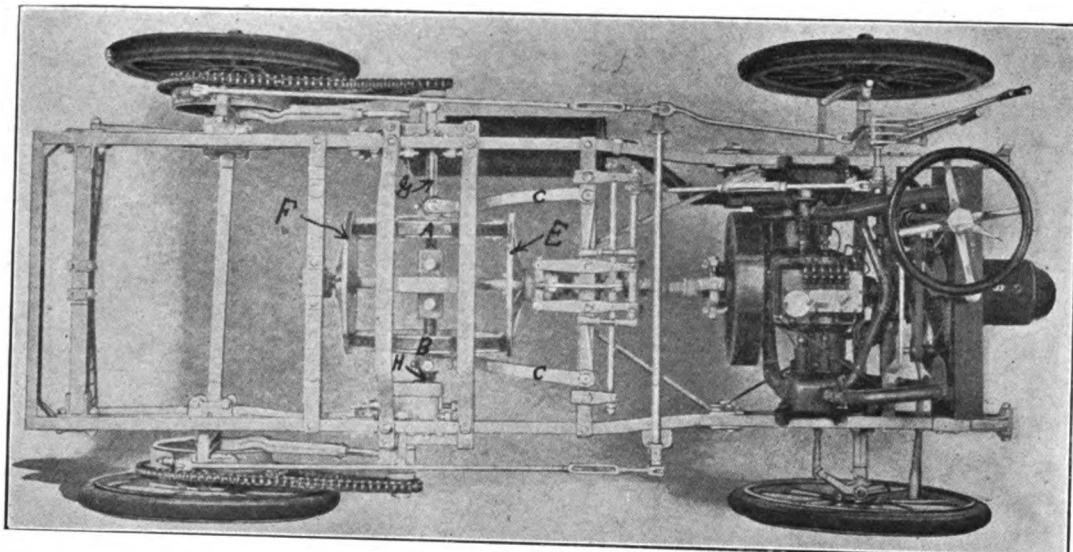

PLYMOUTH CHASSIS.

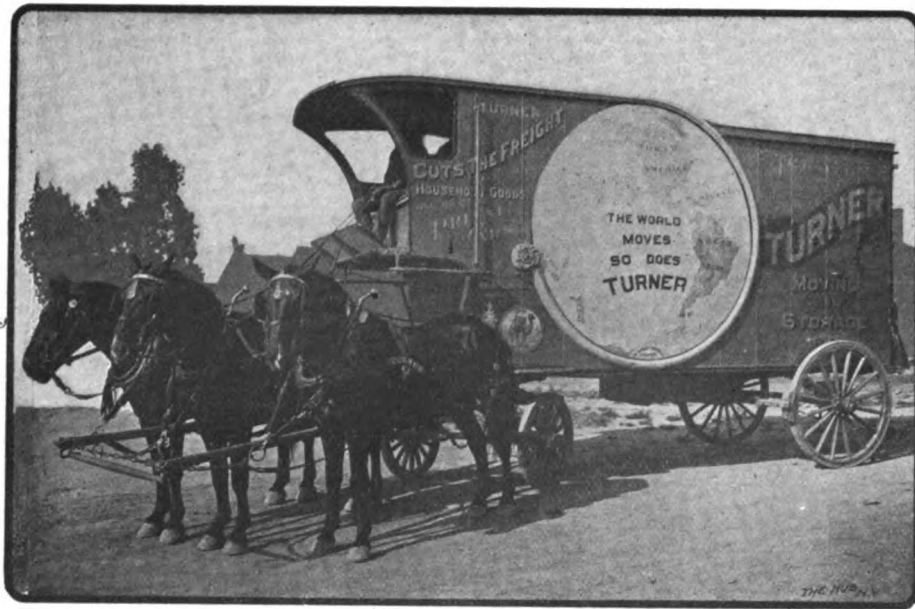

NOVEL MOVING VAN.



BALTIMORE MERCANTILE TRUCK.

Description of Fashion Plates

Making a specialty of wagons enables the Hoover Wagon Co. to produce pleasing as well as worthy goods. The two illustrations shown are nice examples of light delivery work.

The platform vehicle is attractive for its panel work especially. The rear is made with double doors. The illustration tells the working details without additional comment. The wagon is catalogued as No. 212.

The fancy paneltop wagon is shown for its interesting panel treatment. It shows that merchant wagons can be made something beside utility affairs. The body is a solid panel frame top with round front corners built solid from the sills, with front parts and panel curved.

German Sight-Seeing Wagons.

The sight-seeing wagon illustrated is of German origin, and shown for the reason that it displays better treatment than the arks we are accustomed to on our streets devoted to the same use. There is a parcel carrier on the top that is a practical suggestion.

Alpena Motor Car.

The illustration of the "Alpena Flyer," made by the Alpena Motor Car Co. is that of a car weighing only 2,250 pounds. The advantage of light weight with sufficient power are too desirable to need talking about.

The unit power plant and three point suspension is here illustrated. It is 4-cylinder, 4 cycle, cast in pairs, the h.p. being

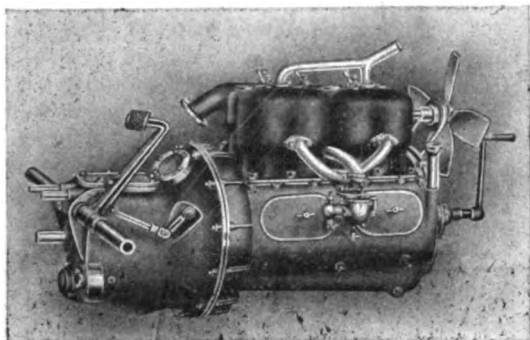

33.6. The clutch is multiple disc, dual ignition and Schebler carburetor. The base is 111 inches. The road clearance is 12 inches. The usual attachments go along. The body of the car is pleasing in design. The success has been achieved by concentrating on a single model and making that the best possible.

Novel Moving Van.

The van shown is interesting by reason of the treatment of the panel used for advertising purposes. Its extension from the top on a half circle with the remainder of the top dropped slightly shows what can be done with the idea of attracting attention.

Two-Horse Truck.

We illustrate a truck characteristic of Baltimore. There is nothing else of moment to comment on save what an inspection of the illustration will reveal.

THE PLYMOUTH TRUCK.

(See illustrations.)

One of the principal features of the Plymouth is the double variable speed friction transmission, simple in construction and versatile as to the changes of reductions at driver's command. By the use of it they dispense with the clutch, speed change gears and the differential.

It is accomplished as follows: When turning a corner (for example to the right), the driven friction wheel B will immediately

creep in toward the centre of the disc automatically, resistance upon the drive wheel in contact with the ground causing it to meet a place on the disc of equal speed; the controlling arms C and C are made with enough flexibility of movement to permit such action, and the friction wheels do not slip on the discs or the drive wheels upon the ground as many suppose. This action is entirely automatic, requiring no attention on the driver's part.

Another feature is that each rear wheel being driven independent of each other, should one strike a slippery place it will not spin, as in a car using a differential.

An explanation of the friction transmission is as follows: The two friction wheels A and B move toward each other, approaching the center of the discs E and F for slow speeds, getting their driving contact from a small circle on the disc, which gives a big reduction from the motor to the friction wheels A and B, and still another reduction from the sprockets on the friction wheel shafts to the sprockets on the rear wheels of the truck and by separating the friction wheels A and B they can be brought to the outer edges of the discs E and F, reducing the reduction and increasing the speed. Any point on the disc can be used from the slowest speed to the highest, both forward and reverse, providing many speed changes at the driver's command to meet conditions as they actually exist in every day work.

Main frames are of channel steel thoroughly braced and hot rivetted throughout.

The operation of the Plymouth truck is simple, one foot pedal operated by the right foot giving the forward speed and one operated by the left foot the reverse. As these pedals oppose one another it may readily be seen that both the forward and reverse cannot be applied at the same time, though may be instantly changed from forward to reverse, or vice versa, without danger of injury to any of the parts, and when going forward the reverse may be used as a brake or when reverse the forward may be used likewise, at which times the power of the motor is being utilized in controlling the truck. Powerful continuous band emergency brakes are also provided, operated by a hand lever.

USE OF GREASE CUPS.

The use of grease cups on wood-working machinery is a comparatively new wrinkle, but one conducive to economy of time and money. Especially adapted to heavy moving parts, they can be used for much of the shafting and many of the heavier machines. While not particularly adapted to the higher speeds, they are used on loose pulleys with success.

Instead of having to climb up under the ceiling to oil a loose and a sleeve pulley twice a day regularly, and several times in between if machine was used much, there was no need to bother once a week. These two pulleys would throw out nearly all the oil in a couple of minutes, and then run dry in a couple of hours, and it was no uncommon thing to use half a gallon of oil a month on the two alone. The loose pulley became so worn that it pounded around with about ¼-inch to go on, and the two were taken down and rebabbitted. While down they were fitted with compression grease cups, one of the two being an automatic self regulating one. These were both fed pretty fast for a day or so after being installed, then toned down to just feed grease as it was used.

Instead of an oil shower every time that shaft was oiled, the oiler once a week looks them over and turns up the non-regulating one a turn or so. The other is set to feed a stated quantity, and it feeds this until the cup is empty. In two months these used up four cups of grease, value not over 10 cents, against a gallon of oil at value of 45 cents, and saved at least ten minutes time a day.

DIFFERENT KINDS OF OAK.

It will surprise most persons who know something about oak to be told that the so-called white oak timber of our markets is often a mixture not only of various species of the white oak group, but also of other species, such as the red oak. This generally unknown fact is reported by the U. S. Department of Agriculture, which, as a part of its forestry work, is frequently called upon to pass judgment upon the identity of market woods in dispute.

Foresters divide all the oaks into two distinct groups—the white oak group and the black oak group. One way of distinguishing the two is by the fact that the black oaks require two years to mature their acorns, while the white oaks take but one. The woods of the two groups are also structurally different. The true white oak, known to botanists as *Quercus Alba*, is merely one of the species which make up the white oak group. Red oak, on the other hand, belongs to the black oak group. Red oak has a number of other common names, among them mountain oak, black oak and Spanish oak.

There is so much confusion in the ordinary use of names of the oaks that it is almost impossible to keep them straight without resorting to the scientific names, but the marketing of wood of the black oak group as white oak is hardly fair to the consumer. Red oak, for instance, is now much more abundant than white oak, grows faster, and is generally regarded as inferior. The two species often grow together and occupy the same general region.

In the early days of its abundance, market white oak was derived almost entirely, it is safe to say, from *Quercus alba*, the true white oak. This species combines approximately the utmost strength and toughness of any of the timber oaks, excepting possibly the southern live oak, which in the early colonial days was so highly prized for shipbuilding that it was protected by special laws. The immense inroads made upon the then apparently inexhaustible white oak forests, which stretched from the Atlantic seaboard to about Missouri, gradually so reduced the supply that the use of other species became inevitable.

At the present time it is almost impossible to obtain a consignment of white oak that does not contain pieces of some other species. Of the white oak group those most used, in addition to the true white oak, are bur oak, chestnut oak, chinquapin oak, post oak, swamp white oak, cow oak, and overcup oak; of the black oak group, Texas red oak, red oak, and spotted or water oak.

Real white oak timber of number one quality is very largely cut into quarter-sawed boards, while a combination of one or more white oaks and red oak may constitute other cuts of "white oak." In many markets, the term "cabinet white oak" is now understood to include a mixture of white oak and red oak, while it often signifies red oak only.

The question, "What is white oak?" is now coming up among consumers and manufacturers of commercial oak timber. The above named white oaks are distinct but closely related species, which together must be depended upon for the future supply. For the ordinary purposes for which true white oak is used, practically all the trees of this group yield woods that can be interchanged and will serve equally well.

DEAL CONSUMMATED.

With the purchase of \$50,000 worth of lumber and unfinished wagons of the Keller Wagon Company, at Joplin, Frank Fellows, president of the Springfield (Mo.) Wagon Company will move the entire stock to Springfield. Mr. Fellows secured all of the hardwood lumber as well as a number of wagons that were under course of construction when the Keller factory suspended business. The Joplin wagons will be completed in the Springfield factory, but they will not be sold as Springfield wagons.

CARRIAGE MAKERS FEAR TIMBER SCARCITY.

If hickory and oak, suitable for wagon and carriage manufacturing, is cut indiscriminately, as is now being done, the supply will be exhausted in the course of the next fifteen years, in the opinion of members of the Wagon and Carriage Woodstock Club, organized recently in St. Louis, Mo.

Representatives of fifteen manufacturing concerns of Missouri, Illinois and Indiana met to form an organization to induce conservation in the use of timber and to regulate the grades of wood used. It was agreed that the present range of prices is inadequate for the quality of goods turned out and a recommendation was made that there be a slight advance. Growing scarcity of oak and hickory, it is claimed, has caused the price of working material to soar.

Those chosen as officials of the club are: B. F. von Vehren, of Evansville, Ind., president; Joseph Brown, of North Manchester, Ind., vice-president, and Frederick A. Curtis, of Chicago, secretary and treasurer. St. Louis has been designated as the meeting place and members will assemble several times each year.

IS THIS TRUE?

Some time ago a certain well known business man in Chicago bought an electrical vehicle for his personal use. Not long after this he greatly surprised his friends by appearing around town in a gasoline touring car, and when asked for his reason for substituting the gasoline for the electric car, he explained that the electric had not sufficient mileage capacity on the Chicago roads.

It was not the fault of the car, but of the roads. Many a purchaser of an electric vehicle has found to his chagrin that a car which was supposed to have a mileage capacity of forty, fifty, or sixty miles, when put to the test of actual experience, was able to run only twenty-five or thirty or thirty-five miles.

It is astonishing what a difference in mileage capacity there is between running on a bad road and a road which is well built and kept in good repair. Any electric car has a large overload capacity, and this usually enables it to negotiate successfully some very bad roads, but only at the expense of an abnormal drain on the batteries which, of course, materially cuts down the mileage capacity of the vehicle.—*Electrical Review*.

HANDY TOOL FOR THE SMITH.

This is a very handy tool for making spring and axle clips, says E. C. Fay. A practical smith can make it in a very short time and it will save him many heats, and much time and trouble when making clips for springs and axles.

Get an old axle stub and heat one side of the square part and furler as shown, making a straight groove of equal depth for a

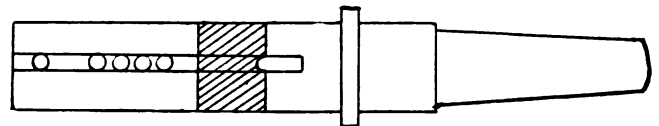

reasonable distance. Now drill a number of holes through the axle from the groove side. These holes should be so spaced as to accommodate several sizes of springs and axle clips. By using this tool a smith can easily forge a clip in one heat.

GOING AGAIN.

The Conquillard Wagon Works, Henderson, Ky., is in full operation again after a suspension of several months. The plant made an assignment to the Ohio Valley bank in November. The firm received an order for 1,500 farm wagons to be manufactured for Sears & Roebuck, of Chicago. Seventy-five old employees were given employment. It will require probably a year to complete the contract.

INSIDE TIRE POINTS.

Why the Price of Tires Does Not Go Up in Proportion to the Increase in Raw Rubber.

What surprises people is the fact that tires do not go up in price something like raw rubber. They still feel convinced that the prices will go a lot higher than they are to-day, their idea being that, perhaps, the tire manufacturers have, for the present, the advantage of the lower prices ruling some time ago.

As a matter of fact, the substance which the ordinary consumer calls "rubber" is a composition which obtains its resiliency, elasticity and ability to recover its shape, after being stretched or distorted, from the amount of rubber which enters into the formula—given, of course, careful treatment in manufacture. The proportion of rubber in a composition depends entirely upon the class of work in which the composition is to be employed, and a very important point is the quality of the rubber. In some rubber compounds the proportion of rubber is as low as 5 per cent, and yet, the compound has all the attributes of the very best compounds, one of the tests applied being an attempt, after making a cut, to tear the compound apart. Just what proportion of rubber is required in the making of tires is a trade secret. And partly to this secrecy may be due the fact that the number of successful makers of tires is so small and that there is so much difference between the methods of manufacture apparently employed. The proportion of real rubber used in making the rubber compound, it is obvious, is not very great. And it seems to be generally agreed that the Brazilian Para rubber is unequalled for tire work.

Another important fact is that more than one-half of a tire consists of fabric and of the hard material, with very little rubber in it, of which the beads are made. Consequently, we are able to come to the conclusion that, instead of motor tires consisting mainly of the best Para rubber and, therefore, being liable to rise in price proportionately to the increase in the market price of Para rubber, they contain but a small proportion of that useful raw material and, therefore, are but slightly affected in price. As a matter of fact, a tire made of unadulterated rubber would be of no earthly use. The makers know the best proportions to use for securing flexibility, long life, and resistance against cutting.

That raw rubber can keep at anywhere near its present inflated price is quite impossible. In fact, it is not going too far to say that the present prices are not justified. Ten years ago the annual consumption of rubber by the world was 50,000 tons, and experience has shown that 3 per cent. covers the annual increase in the demand, so that, to-day, the normal demand, allowing very liberally for the rapid increase in the demand for tires, would be about 68,000 tons. Yet the annual output of rubber is 71,000 tons, and the extraordinary increase in the price during the past two years must naturally have resulted in the use of other substances in its place, that is to say, wherever the substance was not required to stretch or deform and to recover its shape. Thus, paper is now largely used for insulation of electric wires. Excessive prices are always compensated for in this way; substitutes and new methods are found that reduce the demand, and the prices come back to their normal level once again.

HINTS.

If your varnish works into a sort of foam as you apply it, or makes little air bubbles, it is too warm. Work out the air bubbles with tip of the brush.

A varnish that has too much drier in it will be brittle, and also the same if it has too little oil, making what is called a short oil varnish. Cheap varnish is apt to be brittle because of the rosin in it and from the fact that it is usually thinned with benzine.

The Minneapolis Motor Truck Co., will move its factory to Downing, Wis.

DESIGNING.

The Automobile and Carriage Builders' Journal approaches this well-worn subject somewhat interestingly for beginners. We quote:

All vehicles which are made for the carriage of passengers are designed according to a set of very simple rules, which, when one really understands, enables the learner to set out the leading features of any vehicle, including an omnibus, whether it be a private one or a double-decked hackney carriage.

The size of the average adult human frame, especially when seated, decides the leading dimensions, which may be considered under the heads of seat, leg, knee and head room.

Seat Room—A minimum width of seat is 16 inches. A single brougham, if measured on the seat between the standing pillars, will probably measure some 3 feet six inches, this being the allowance for two persons. Here the 21 inches per person may be looked upon as comfortable as circumstances allow, and if you increase it and have side support, as in a bucket seat, you will only be creating free space, which is useless. In an omnibus every inch we give per person means a great deal of difference in the length of the vehicle, if even four a side are seated, so that the minimum measurement is hardly likely to be exceeded to any great extent. If 17½ inches are allowed each side per person, then this is sufficient, bearing in mind the style of body. The seat is also set a certain height above the floor. Measure that very easy chair at home—you will probably find it about 14 inches to the top of the seat, but then you have to lean right back to get the full comfort, and extend your legs, and seek the aid of a footstool to enjoy the chair to its full; but you cannot do this in a 'bus, for that matter, in the majority of vehicles, unless you are the only occupant. For the ordinary sitting posture with the ability to lean back without discomfort to the lower leg and ankles, 18 inches is ample, especially if the back is rather straight, as in a 'bus; while in a large limousine or a side entrance phaeton 16 inches gives more luxury, especially if half of it is a scientifically made spring cushion. As regards the depth of the seat, 16 inches is the minimum, and a chauffeur or a coachman on his box is seldom asked to sit on less, and 18 in. may be taken as normal. If the measurement is increased beyond 22 inches, it becomes an effort to use the back squab properly. The height of the top of the squab should be 22 inches from the bare seat board, but it is often less, especially in some suburban railway carriages.

Leg Room—This measurement has been referred to when considering the height of the seat above floor. The coachman likes some 22 inches to 24 inches to the toe of the footboard at an angle of 45 degrees from the front of the driving seat, in order to get a proper purchase for his feet, while the measurements in a motor car will be about the same with slight differences according to the exact position of the pedal control and angle of steering. The measurement taken horizontally from dashboard to driving seat on motor cars run from about 21 to 31 inches, but this need not worry the student, as this measurement is already determined for him by the motor manufacturer.

Knee Room—This may be reckoned as depth of seat plus the distance from front edge of the seat to the back edge of the one in front or simply as this last measurement by itself. In a limousine landaulette, where the motorist has insisted on an extra pair of single seats facing forwards and at the same time has bought an ordinary length of chassis, the probability is that the distance between the seats is only 9 inches, it should be 12 inches at least. In an omnibus or wagonette where there are two sets of opposing knees to contend with, more space still is required unless the knees are to be dodged. That is why the seat in a private 'bus is generally wanting in depth, because the greater part of the available overall measurement has been given away in the gangway. The cross measurement of a private 'bus will be kept down as much as possible, because one does not wish to increase the track and general weight of the whole framing, just for the sake of an inch or two, in a vehicle which is only to be ridden in for a short time. In a single brougham it is different,

we have only two seats to study, although the knee room will not always be unlimited if a customer wants a light one-horse brougham for a hilly district. A gangway between two opposing sets of seats should not be less than 18 inches and at least 24 inches if it is a public service vehicle where there is much "inning and outing."

Headroom—In a public garden seat 'bus it will be as few inches as possible beyond 6 feet in consequence of a top deck load and the centre of gravity. In a private single deck 'bus it will be such as you can comfortably sit down in with your hat on. If the 'bus body is long then a few inches will be added, so that you do not have to crouch unduly in getting to the seat next to the front of the body. In a brougham it will be at a minimum, because you go straight from the step tread to the cushion. Here it will be about 3 ft. 6 in. off the bare wood. In a long limousine, or under a cape cart hood, or in an eight-seat 'bus, you will probably find 4 feet to 4 feet 2 inches.

Height of the Body from the Ground—In a motor car, as with front seat knee room, this is given you in the chassis itself and will be found to vary from 20 inches to 27 inches. Add the thickness of the rocker or bottom side, or whatever you have to step over in order to get into the body, divide it by two, and you get the height of your long side or other step. If you believe in taking into consideration a 4 in. street curb, do so by all means, but, on the other hand, a curb is not always at hand. With a carriage, you will find that an elbow line of 3 feet 6 inches to 3 feet 8 inches off the ground suits a crowd of vehicles, or you can work upwards step by step. Thus, for a brougham, first comfortable step 10 inches, another 10 inches to body 20 inches, height of seat above floor 16 inches, or seatboard 10 inches, allowing 6 inches for cushion, depth of quarter 12 inches. Adding up, $10 + 10 + 10 + 12 = 42$ inches, or 3 feet 6 inches. If you want a vehicle to look important, such as a C-spring barouche, you do not study convenience, but you worship style, and stick the elbow line up to 4 feet, and if you stick it up another 3 or 4 inches, you will be in the air on a level with a full dress coach. Here you sling the body up, and design downwards to suit by having a folding step, but, as with the other considerations, there is no magic in it, it can all be thought out if only you have the courage to burn that rough sketch with its litter of "sizes" and think out the principle of the thing.

If our 'bus has four a side, then it will be four times $17\frac{1}{2}$ in. on the seat plus the thickness of the pillars at each end—say twice 3 inches—making 76 inches, or 6 feet 4 inches overall. Then your axle goes under the body, not at the back of it as in brougham, so you will have to crank it, unless you have a very high body or unsightly low wheels. You do not want to crank the axle unduly, and necessitate a tremendous strength at the crank; so things are kept at a balance, and the bottom is made say 24 inches off the ground, out of which the axle steals 6 in. for clearance. Then you want the seat about 12 inches off the floor, and the head room will be 4 feet 2 inches, so that you have got 4 feet 10 inches, or thereabouts in which to crouch, which won't be such a terrible job, even if you are 5 feet 8 inches without your boots. The height off the seat has got to be divided into rise in roof, cant rail, light (with or without ventilating rail), and side panels (with or without belt or waist rail panels). Try the 22 in. normal measurement above the seat for the bottom of the light, and see how it shapes with your length of panel. You will decide that it looks proportionate, so that it will not spoil the appearance to add a 5-inch waist panel. The rest, so far as the height goes, will be light, and the width of it will be according to taste. The vertical panels between the lights and at the ends must not be too small, as it will hardly be worth while framing up for them, and if too large you are going to darken the body.

Control of the Economy Motor Buggy Company, of Joliet, Ill., has been secured by the Studebaker Automobile Company. The plant will be enlarged by the erection of new buildings and the addition of new machinery.

THIS IS SO.

W. C. White, a vice-president of a big car making concern, speaks a little piece that is about as good as an editorial expression, and as we fully sympathize with the point of view, we are glad to quote:

Rapid as has been the growth of the gasoline car industry, measured in terms of production, still more rapid has been the development of gasoline car design. In the early days of the industry, designers centered their energies on the development of a car which could be depended upon to keep going with reasonable regularity. In more recent years, other considerations, such as comfort of passengers, quietness and flexibility, have received increasing attention. These qualities having been in a measure secured, the leading foreign designers and those American makers who are acting in accordance with foreign practice have very recently taken up such qualities as simplification of design, low fuel consumption and minimum cost of up-keep.

To maintain that perfection in design was reached three, two or even one year ago, or that only minor refinements have since been necessary, is to confess ignorance of, or indifference to, the advance which has meantime taken place. The discriminating buyer will appreciate that a car of the latest design will be the most satisfactory, provided of course, that workmanship and material are in keeping with the design.

One of the modern tendencies in design is toward the "long-stroke" engine. The development of the "long stroke" engine is due largely to the fact that a year or two ago the rules of the great international races held abroad imposed limits on the diameter of cylinders and also limited the fuel consumption. The principal European makers, who were at the time all interested in racing, thereupon proceeded to develop higher powered engines of limited bore, by the simple expedient of increasing the stroke. It was also found that by increasing the stroke the desired economy in the use of fuel was secured. As the new construction was in every respect advantageous it was but a short step to develop the principles acquired in the construction of racing cars, so that they might be applied to cars built for general touring purposes. It is significant of the wide-spread adherence to old ideas that the standard formula used in this country for computing horsepower does not take into consideration the length of the stroke and it is, therefore, to that extent, defective and unreliable. The most important of the new developments, however, is the recent tendency to simplify the design by the reduction of the number of parts.

PUTTING HOLES THROUGH GLASS.

Glass is universally conceded to be exceedingly difficult to work when cold, yet its fragile nature often calls for means of repair. It is also desirable sometimes to drill large holes in glass plate, or through a glass column, which is not an easy thing to do with any facilities hitherto developed for such work. In the opinion of a writer in the Electrician and Mechanic, the best fluid to be applied to the glass so that the tool will take hold is that of the formula given below. It has been developed after many experiments with different mixtures, and will be found to be superior to anything heretofore known. With a bastard file wet with it, a piece of plate glass may be put into a vise and filed like wood; any other cut of the file may be used, but where there is much glass to remove, the coarser the file the better.

Pulverized camphor 2 oz., sulphuric ether 6 drams, enough oil turpentine to make a 6 oz. bottle full.

WHAT THEY SAY.

The new Mercer Wheel Company factory building at Burlington, Iowa, will be one of the best designed wheel works in America, as it is the latest built and the plans were drawn under the direction of W. G. Mercer, who has had years of experience in the manufacture of wheels. The force is now at work on the power plant.

Carriage and Automobile Painting

HOW TO TREAT A BRUSH.

Never let paint brushes lay in water—it kills the spring of the bristles. After using brush, wash it out with benzine, turpentine or other thinners, and soak the brush in raw linseed oil. Lay it out on a flat surface or hang it in a vessel filled with raw oil. Do not let the brush touch the bottom, or the bristles will turn.

Old brushes can be easily cleaned by soaking them in a strong solution of pearline water for 48 hours, and washing them out afterwards with water. This will not affect the bristles.

If partly worn brushes are cleaned as above they make the best kind of brushes for the use of shellac, as alcohol softens the bristles in a new brush, and it soon becomes flabby.

Creosote oil is a good cleaner for badly used brushes.

If the bristles in a brush are weak, use the brush in a turpentine stain for a while before putting it in paint, and it will be benefitted.

Varnish brushes should be kept in varnish at all times, but care should be taken that the bristles be entirely covered with varnish, and that the brush does not touch the bottom of the pot.

Varnish brushes, when not in use, can be kept in good shape by dipping them in wax that has been diluted with turpentine. In this way a varnish brush can be put away for months without hardening the bristles, but care should be taken to wash the brush thoroughly before using again.

To straighten the hair in pencil brushes, pour a little raw oil on a piece of glass and hold a lighted candle under glass, draw pencil through the hot oil several times, and the hair will straighten.

Look out for moths. They will attack bristle as well as camel hair goods. Put a few moth balls in the drawers or boxes.

Use glue-set brushes for applying shellac and spirit varnishes.

CARE OF VARNISHED SURFACES.

No varnish will endure being scrubbed with a brush or with hot water. It is not iron or tile or leather. No varnish will endure the chemical action of ammonia or pearline, or any kind of lye soap, or any of the common washing fluids or washing powders. No varnish will endure having dust or mud rubbed off, or wiped off, or will endure having the grits of dust and mud driven into it by the water blast from a high-pressure hose, such as carriages and motor cars are subjected to.

Mud, wet, or dry should be removed from a carriage or motor car with flowing water, squeezed from a clean sponge, or flowing from a hose with very gentle pressure—not a water-blast. There is no surer or quicker way to ruin the finish than ordinary public garage or livery cleaning.

The less soap the better. On a carriage there is no need of using it at all. On a motor car it should be used only where oil is spattered. If there is much spattering of oil, you need a new chauffeur. Unless the bearings are flooded for a race, a greasy car is due to ignorance or carelessness. However, what grease there is may be washed off with soap. Use a good, pure carriage-cleaning soap—and that only where necessary. The thick and solid grease spots may be removed by waste that is dampened with benzine or naphtha.

The ideal garage or carriage house is concrete, treated with Konkreto. If this is not convenient, then have it warmly built, and keep out drafts. When not in use the carriage or motor car should be covered with a white muslin cover, and the cover

should preserve its whiteness. Do not stand the motor car or carriage in the stable, or near the horses—ammonia fumes are deadly to varnish.

However well the varnish has endured our weather testing, it may be seriously affected by instant extremes of temperature. A glass dish may be filled with boiling water (slowly) without cracking it; and may be filled with ice water (slowly) without cracking it; but you must not plunge it instantly from boiling water into ice water. Don't open opposite windows of a warm room so that an icy wind blows on the piano. Don't allow servants or children or curious people to lay their hands on the carriage or motor car—it creates the instant change of temperature.—The Decorator.

G. B. HECKEL ON PAINTING.

(Extract from paper read at a convention of painters.)

Painting and decorating is an industry peculiarly dependent upon chemical laws, and the workman who understands these laws is doubly equipped for his trade.

Without going too deeply into the subject, it is necessary to get a few fundamental facts firmly fixed in our minds before we proceed to the actual shop chemistry. The first fact we wish to remember is that outside of the eighty-odd recognized "elements," everything in nature is made up of two or more of these elementary substances in definite proportions. Second, that the combinations of matter are governed by their combining weights, and that, knowing the combining weights of the various components of any material, we know just how much of each component it contains. Thus water is a chemical compound of oxygen and hydrogen in the proportion of two weight equivalents of the latter to one of the former. The weight equivalent of hydrogen is 1, that of oxygen 16; therefore in every 34 pounds of water there are 2 pounds of hydrogen and 32 pounds of oxygen.

White lead is a compound of metallic lead, oxygen, hydrogen and carbon. A part of the oxygen and all of the hydrogen are in direct combination with a part of the lead; another part is in combination with the carbon and another portion of the lead.

Zinc oxide is a combination of zinc and oxygen. Red lead is a compound of lead and oxygen. Litharge is a similar compound, containing two combining equivalents less of lead and three less of oxygen. Ocher is a compound of iron, oxygen and the elements of water mixed with clay. The red iron oxides are combinations of iron and oxygen without the water and clay. Putty—that is, the putty of the textbooks—is a compound of calcium, carbon and oxygen (whiting or chalk), ground with linseed oil. Venetian red is iron oxide intimately mixed with gypsum or some other colorless material.

And so we might go on through the entire list of materials you use, always coming upon chemical facts, which would enable us to determine, had we sufficient knowledge of the science, whether the product were well or ill adapted for our use.

One little bit of chemical knowledge has been so persistently impressed upon us for two generations past that I presume you are all familiar with it; the fact that carbonic acid, oxygen and hydrogen can be driven out of their combination with lead by means of heat. The blow-pipe will thus reduce any weak combination of lead. Red lead, litharge, acetate of lead, chrome yellow, etc., will all yield a lead bead on charcoal under the blow pipe. Similarly the process can be reversed, for by subjecting lead to a melting heat with free admission of air, we obtain first litharge and from litharge finally red lead. But the stronger combinations of lead are not so easily reduced. It is much more

difficult, for example, to obtain a lead bead from the sulphate or the sulphide.

This fact brings us to another chemical law which plays an important part in the building up of the very earth on which we live. In chemical reactions stable combinations always tend to replace unstable combinations. If two compounds be in solution and by interchange of their components an insoluble substance can be formed, the interchange will take place and the new insoluble compound will be precipitated. This interchange is taking place all the time in the heavens above, in the earth beneath and in the waters under the earth.

To illustrate this law I have here two solutions, one of barium chloride, the other of odium sulphate—ordinary Glauber's salt. The barium compound is formed of one atom of barium (a metal) and two of chlorine (a gas). The Glauber's salt is formed of two atoms of sodium (a metal) and one molecule of sulphuric anhydride—that is, sulphuric acid in which the hydrogen has been replaced by sodium. Thus, sulphuric acid is composed of two atoms of hydrogen, one of sulphur and four of oxygen, while Glauber's salt contains two atoms of sodium replacing the hydrogen of the acid.

Now, when we mix these two solutions we find that a white precipitate forms, which, being very heavy, falls rapidly to the bottom. This precipitate is a compound with which you are all more or less familiar. It has been formed in the earth in ages past, probably by a similar process. Being mined and properly prepared it appears in paints as our old friend barytes. The sulphuric anhydride of the Glauber's salt has changed partners, so to speak, with the chlorine of the barium chloride "in order to form" (in the language of the Declaration of Independence) "a more perfect union," and the sodium has to get along with its new partner chlorine, as common salt, which remains in solution.

Let us now put this experiment to practical use and do a little stunt of chemical wood filling. I have here a soft pine board, the surface of which is saturated with barium chloride. Brushing over it a little of our Glauber's salt solution, we precipitate the barytes in the very substance of the wood. I wonder whether barytes in this form should be regarded as an adulterant or as a reinforcing pigment.

Applying this principle to the painting craft, we shall begin to understand some otherwise mysterious performance on the part of paint. We know that under certain conditions white lead will darken rapidly, under others slowly, and then after the lapse of time, if there is any of it left, will regain its original color.

This action is due to the same law that caused the fall of barytes in our test glass. The combination of lead with sulphur is more stable than its combination with oxygen and carbonic acid.

STENCILS.

The character of a stencil depends on its "ties." The Japanese have a method, the exact process of which is not known, but specimen stencils show that the ties are not left as part of the stencil design, but are formed by fabric, which both supports and is supported by an upper and lower copy of the stencil, the whole forming one.

It is not probable that our Occidental craftsman will ever work with the exactitude which is the characteristic of the Japanese craftsmanship. The fine results of Oriental craft are not likely to be realized. But a hint may be obtained which will greatly aid in the cutting of stencils of a finer and more effective character than usually found in Europe.

The process is probably as follows, though it has not actually been seen in operation. The design is cut through several sheets of Japanese paper which has been stiffened and rendered impermeable in the same way as our stencils are treated with oil and shellac. One copy is then taken, and fine silk threads are attached to the borders and passed across the design. Another

copy is then laid on top of the first one, and fastened down in exact register, thus imprisoning the fibres.

It is obvious that with such delicate and complicated stencils, the repeat in design is less visible, even when stencil only is employed. When several are used the junctions are quite imperceptible.

DERIVATION OF VARNISH.

Varnish came by its name along the romantic route. Bernice, wife of one of the Ptolemys of Egypt, a grand-daughter of a half-brother of Alexander the Great and an ancestor of the lovely Cleopatra, was blessed with a crowning glory of red-gold hair. The Greek sailors, in their voyages to distant African ports, occasionally found the rare and valuable resin now known as amber, and called it Berenice in honor of the beautiful Egyptian queen's tresses. Berenice is equivalent to the Greek Pheronice. Ph sometimes had the sound of v, and the name was pronounced Veronice. The Romans, referring to the amber, made it vernice, and their descendants further changed it to vernis—hence Vernis-Martin. The Anglo-Saxon form became varnish.

CHEMICALLY OR COMMERCIALY PURE.

The relative merits of oxide of zinc which is practically chemically pure as compared with one which is only commercially pure remind us that mere chemical analysis tells very little about the intrinsic merits of paint. This is a point which has too long been neglected not only by the manufacturer, but also by the practical user of paint materials. The time appears to be at hand, however, when the true facts of the matter will be better understood. Physical condition, which includes such factors as fineness of grinding, etc., are now regarded as the ultimate points which determine whether or not a given sample of paint is likely to behave satisfactorily in use.

It cannot be denied, of course, that if we once admit the principle that it is permissible to introduce cheapening material into a complex paint mixture we are at once laying ourselves open to the tactics of unscrupulous manufacturers and merchants.

This objection, however, can readily be overcome by making more use than formerly of paint experts. Indeed, the paint expert appears to have a useful and interesting career before him. The whole subject of paint has become so complex and so many facts and theories have been introduced during the past that it requires a man who has specialized in this direction for many years to give authoritative opinions on many of the good points submitted to him.

"STAINING, VARNISHING AND ENAMELLING."

This is the title of a book, 118 pp., that comes to us from England bearing the imprint of The Trade Papers Publishing Co., Ltd., 365 Birbeck Bank Chambers, W. C., London. We also notice it carries the imprint of the Painter's Magazine, New York, on same page.

The book is written by J. H. Galloway, and edited by A. S. Jennings. The editor in his foreword says he has practically tested the operations described in the book, having many times personally carried them into effect.

The book is very largely devoted to the interests of the interior decorator and many of the subjects might not be interesting to vehicle painters, save as they might be generally interested in the art. There are, however, many very useful suggestions.

Under the heads of Spirit Varnish and Vehicle Stains, and Varnishes and Their Uses, the matter is of a character that can justly be called practical. The method of presentation is clear and simple, just as it always is when a writer is master of his subject.

STUDEBAKER'S AUTOMOBILE BRANCH.

Studebakers have moved their automobile department to the new seven-story building at Michigan Avenue and Twentieth Street, Chicago, right in the heart of Automobile Row. The new structure is one of the most commodious and complete motor car establishments in the world. The old stand will be devoted entirely to the developing business in horse-drawn conveyances and accessories.

The new seven-story building occupies the northwest corner of Michigan Avenue and Twentieth Street, and is of reinforced concrete. The dimensions are 75x175 feet. It is equipped with a passenger elevator, a 16,000 pound freight elevator, and a 250-pound automatic elevator. The automatic elevator is under the control of the storekeeper and is for the purpose of transferring



Studebaker Automobile Co's New Chicago Branch.

parts to and from various departments. Devices are provided on each floor whereby all dirt, refuse, shavings, etc., are transmitted to the basement automatically.

There has also been a vacuum system installed throughout the entire building for cleaning purposes. The building has also been equipped with a Duplex air compressor with capacity sufficient to maintain 90 pounds pressure throughout the building.

The entire structure is provided with latest style wash and lavatory fixtures, including shower baths on some of the floors. There has also been installed an autogenous system for welding and strengthening purposes.

In the basement there has been provided a chauffeurs' room which contains all conveniences, such as telephone, writing materials and reading matter.

The salesroom is finished in silver oak, with Mosaic hexagon tile, terra cotta color, the wall and ceiling decorations being carried out in a warm gray tone. The furniture throughout the building is silver oak, to match the wood trimming.

The stock room is supplied with all-metal shelving. Some idea

of the size of the room may be gained from the statement that it requires 14,000 pigeon holes to care for the various parts. On the ground floor, in the rear of salesroom, there has been a room provided with 100 compartments large enough to take care of the various accessories of cars which are in the building for repairs, etc.

The shop is completely equipped with all the newest and most improved machinery. Gasoline and oil tanks are entirely enclosed in concrete.

MEASURING ELECTRICITY.

Now that the storage battery is getting to be a big factor in the propulsion of vehicles, it is well to know something about measuring electricity. The cornerstone of the science of electrical measurements rests upon a true knowledge of Ohm's Law. Compactly expressed, it is as follows:

To get volts multiply amperes by ohms.

To get amperes divide volts by ohms.

To get ohms divide volts by amperes.

Illustrative Problems: To illustrate these applications the following cases are given: To find out how many volts are required to send 10 amperes through a resistance of 100 ohms. In this case the volts are to be found; and the two values given must be multiplied together.

$$\text{Volts} = \text{amperes} \times \text{ohms} = 10 \times 100 = 1,000.$$

Next, to find out how many amperes will pass through a lamp taking 110 volts, whose resistance is 220 ohms:

$$\text{Amperes} = \text{volts} \div \text{ohms} = 110 \div 220 = \frac{1}{2}.$$

A physical fact to be kept in mind here is that an incandescent lamp has a high resistance when cold and a much lower resistance when hot. A resistance test would show that the lamp when cold equals 450 ohms, while at incandescence it falls to 220 ohms.

Next, to find the resistance of a coil of wire which takes a current of 2 amperes at a pressure of 110 volts:

$$\text{Ohms} = \text{volts} \div \text{amperes} = 110 \div 2 = 55.$$

These are the simplest illustrations of Ohm's Law as employed by electrical workers all over the world. It undergoes other changes in alternating current theory, because of the fact that additional influences are operating besides those ordinarily appreciated. The above forms, while true, would therefore be inapplicable to circuits carrying variable currents.

TIPS FOR SMALL BUILDERS.

An axle is not perfectly set unless the wheels have a perfectly plumb bearing. That is, the bottom surface of the tire must bear level on a level floor, so that the wear of the tire will be uniform on the wearing edge. Therefore, the only rule we can adopt is to set an axle according to the dish of the wheel.

In building heavy wagons, says W. H. Gunn, in American Blacksmith, I set the axles as follows: Heat axle in center, twelve inches or so; curve a little; put on wheels; turn axle bottomside up; put straight-edge across wheels; then, if both wheels square with the line, and the boxes are wedged truly, the axle is correct. All axles should be gathered slightly to the front.

I have found by actual experience that axles should be set so that the wheel will not run hard on the collar or nut, and so that it will bear plumb on the bottom. It saves the wheel, the axle and the team.

The principle of setting axles by a fixed rule is that the bottom and the front should be at right angles, giving a plumb bearing on bottom and the wheels tracking in a true parallel.

OFFICIAL CONVENTION ANNOUNCEMENT.

Carriage Builders' National Association.

To the Members of the Carriage Builders' National Association:

The thirty-eighth annual meeting of the Carriage Builders' National Association will be held in Cincinnati, Ohio, during the week commencing September 25, 1910. The annual exhibition of parts of carriages, wagons and automobiles; gears, wheels, springs, axles and materials used in their construction; harness, horse equipment, etc., will be held in the armory of the Ohio National Guard, 1419-1431 Freeman Avenue, beginning with Monday, September 26, and closing at 6 o'clock p. m. on Thursday the 29th.

The business meetings will be held in the armory on the mornings of September 27, 28 and 29, commencing at 9:30 o'clock.

As Cincinnati is so well known for its immense carriage factories, its Carriage Makers' Club, and its hospitable people, we can assure our members of a fine reception and a most agreeable time while we are in that city.

The official headquarters will be at the Hotel Sinton, Fourth and Vine streets. It is conducted on the European plan only.

LIST OF CINCINNATI HOTELS.

Hotels on European Plan.

Hotel Sinton, Fourth and Vine, headquarters. The Hotel Sinton is on the European plan only. Rates, \$2.00 a day and upwards; \$1.00 a day being charged for the additional person in room.

Hotel Havlin, Vine and Opera Place. Rates range from \$1.50 upwards without bath; \$2.00 and upwards with bath; \$1.00 is added for each additional person in room without bath, and \$1.50 for each additional person occupying same room, with bath.

St. Nicholas Hotel, Fourth and Race. Rates for rooms without bath one person to a room, \$2.00 per day and upwards; rooms with bath, one person to the room, \$2.50 per day and up; also have a few \$1.50 rooms. For each additional person occupying a room, the charge is \$1.00 per day extra.

Gibson House, Walnut between Fourth and Fifth. Rates for one person in a room, \$1.50 and \$2.00 without bath; \$2.50 and up with bath. For two persons in room the rates are \$2.50 and \$3.00 without bath; \$3.50 and up with bath.

Grand Hotel, Fourth and Central. Rates are \$1.00 up for each person for a room without bath; \$2.00 up for each person for a room with bath; \$1.00 additional for each person for room without bath; \$1.50 additional for each person for room with bath.

Hotel Emery, Vine between Fourth and Fifth. Rates are \$1.00 and \$1.50 per day for each person in room without bath. Room with bath is \$2.00 for one and \$3.50 for two.

Munro Hotel, Seventh and Race. Strictly stag. Buffet and grill in connection. Rates are \$1.00 to \$2.00 per day.

Hotel Walnut, Walnut near Sixth. Rates for one person \$1.00, for two persons \$1.50.

Massey's Hotel, Race and Garfield Place. Rates, \$1.00 per day and up. Meals can be obtained at restaurant on first floor.

Hotel Honing, Vine between Fourth and Fifth. Rates, \$1.00 per day and up.

Savoy Hotel, Sixth between Vine and Walnut. Rates, \$1.00 per day and up.

Hotel Lackman, Vine between Fourth and Fifth. Rates, \$1.00 per day and up.

Hotel Elmer, Sixth and Walnut. Rates, \$1.00 per day and up. Cafe attached.

Hotel Hoemer, Twelfth between Vine and Race. Rates, single, 75 cents per day; double, 50 cents per day.

Hotel Krollman, Vine above Fifth. Strictly stag. Rates, 75 cents and \$1.00 per day.

The Dennison Hotel, Fifth and Main. Rates, 75 cents to \$1.50 per day, each person. Moderate priced restaurant in connection.

Gerdes Hotel, Fifth and Home. Rates, 75 cents to \$1.50 per day and up. Cafe attached.

Stag Hotel, Vine between Fourth and Fifth. Rates, 50 cents to \$1.25 per day.

Hotel Rand, Fifth between Vine and Race. Rates, 50 cents per day and up. With bath \$1.50 per day.

Hotel Oxford, Sixth and Race. Rates, 50 cents per day and up.

Bristol Hotel, Sixth and Walnut. Rates, 50 cents per day and up.

Hotel Princeton, Elm between Fourth and Fifth. Rates, 50 cents per day and up.

Hotel Thoma, Walnut near Sixth. Rates, 50 cents per day and up. Cafe attached.

Hotels on American and European Plan.

Burnet House, Third and Vine. American and European plan. American plan: Two in one room, \$2.50 per day each; single, \$3.00 per day and upwards; with bath, \$3.50 to \$4.00 per day. European plan: Two in one room, \$1.00 per day each; single rooms, \$1.50 per day and up; rooms with bath, \$2.00 per day and up.

Palace Hotel, Sixth and Vine. American and European plan. American plan, \$2.00 to \$3.50; European plan, \$1.00 and up.

Hotel Alms, Alms Place, Walnut Hills. American plan. Rates, \$1.00 per day and up.

Hotel Sterling, Sixth and Mound. American plan. Rates, \$2.00 per day and up.

Directions for Reaching the Armory.

Most of Cincinnati's hotels are located near Fountain Square, from where you can take Seventh Street car or North Fairmount car. From Sixth and Vine take Clark Street car. From Hotel Sinton take Sixth Street car passing Vine and Fifth streets,

which is one block north from the hotel. All of these car lines pass the door of the armory, and from any part of the city it is easy to get transfers for one of these lines.

Concessions in Rates.

As Cincinnati is within the territory of the Central Passenger Association there will be no reduction on the fares, as this association does not give these to associations without a guaranteed attendance of one thousand under the certificate plan, which we cannot give.

Reception and Annual Banquet.

The reception will be held at the Hotel Sinton, Tuesday evening, September 27, from 8 to 11 o'clock.

The annual banquet will be at the Hotel Sinton on Thursday evening, September 29.

By order of the Executive Committee,

HENRY C. McLEAR, Secretary.

Office of secretary, Mt. Vernon, N. Y., August 1.

LAND SHOW PLANS

Big preparations are being made for the mammoth land show to be held in Pittsburg, Pa., next October.

The show will be known as the National Land and Irrigation Exposition, and will consist of United States government exhibits and special models of irrigation and drainage systems sent in by the various immigrations boards and chambers of commerce throughout the country.

The object of the exposition is to provide for the home-seeker, the farmer, manufacturer and investor; authentic and graphic information regarding land openings and possibilities throughout the entire country, and to show samples of the mineral, agricultural and horticultural products of the various sections represented. Many interesting exhibits are being arranged for, and a large attendance is expected.

KILN DRIED LUMBER.

Where the kiln is depended upon for seasoned lumber, there is a way to determine its fitness for use by taking samples of the stock, weighing, then baking them. Take the pieces separately, weigh them immediately, making a memorandum of the weight and the exact dimensions of each piece. Then put them into an oven or dry heater of some kind, bake them for say twenty-four hours, or until it is known that there is no moisture left in the wood. Then take them back and weigh them again, and note if there is any appreciable difference in the weight after baking them and before. By using delicate scales such as can be had from any drug supply house, one may get a very positive test this way. Where it is found that the weight is reduced as much as 4 per cent. by baking, it is evidence that the stock is not thoroughly dry and should go back into the kiln. This is a thorough test, but may not be easy or quick enough for some.

GOING AT THEM AGAIN.

In view of the recent announcement by the interstate commerce commission that it would not suspend the taking effect of official classification of vehicles, the traffic committee of the National Association of Agricultural Implement and Vehicle Manufacturers met in Chicago to prepare plans for a formal complaint to the commission.

THE CHICAGO VEHICLE SHOW.

The annual convention of the National Carriage Dealers' Protective Association will begin in Chicago, October 10. The organization has a large membership.

"We propose to show the strength of the horse vehicles," said Peter Wertz, one of the Chicago members of the association. "We aim to demonstrate that the coming of the automobile has not materially injured the trade in carriages and wagons."

AEROPLANES FOR BEGINNERS.

The sharp advance in practice in the construction of flying machines, and their close approach to the stage of being a commercial commodity makes them interesting to wood-workers, and some idea of the principle of construction should be welcome. We find in the Electrician and Mechanic what appears to be a clear conception of the laws of aviation:

There is an increasing number of people not only interested by the continued advance of aeroplane construction and design, but a surprising number who are making working models embodying the best points of those already made with carefully thought-out ideas of their own, resulting from their experiments. It is by these experiments that improvements will be made, and those which help to solve the many problems now confronting the designers of aeroplanes.

Many have no idea of the scientific principles involved in construction and flight. It is therefore, evident that at least the fundamental principles should be thoroughly understood.

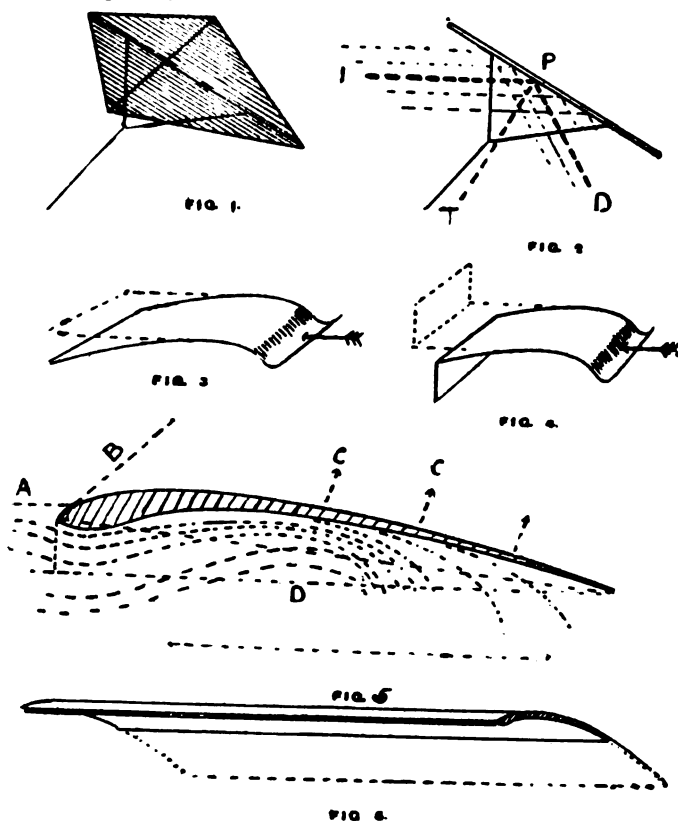

It is to the well known effects of kite flying that we look for our first lesson in aeronautics.

We know that the horizontal pressure of the wind on the inclined surface of a kite causes it to rise, and the stronger the wind the more pull there is in the string. To further illustrate this action of the wind, reference should be made to Figs. 1 and 2. The angle at which the air meets the kite is called the angle of incidence and for all practical purposes it may be taken that the wind is deflected at the same angle. If a line T bisecting this angle I D is taken, it will give the position of the upward thrust, and the centre of pressure at P.

Now, supposing that instead of the wind blowing against a stationary surface, that surface were moved through still air, a similar upward thrust would be obtained, providing that the air so meets the surface that, after passing the angle of incidence, a downward pressure is given to it.

An aerofoil surface, then, must be so shaped to capture the air and propel it downwards. It will then glide through the air. This forms the basis of all aeroplane construction. The most suitable form of surface for an aeroplane is the result of careful experiment, with small planes in front of a powerful current of air.

This form of plane is shown at Fig. 5, and by means of dotted lines the action of the air is shown, that is, of course, when the plane or aerofoil, as it is technically termed, is propelled through it. It will be seen that the undersurface of the aerofoil condenses the air and the curvature of the upper surfaces causes a partial vacuum.

The principal point we have to consider now, is the actual fact that a curved plane directs the air in a downward direction and exerts a lifting effect on the plane; or, in other words, the reaction of the air in the act of being displaced supports the plane.

The most suitable angle at which the aerofoil should meet a horizontal current of air has been determined at about 1 in 8; but with small models this angle may be finer, good results having been obtained with an angle of 1 in 15.

Many interesting experiments may be made to prove the action of air on plane and curved surfaces. Take half a sheet of writing paper and bend it as shown at Fig. 3, blow in the direction of the arrow, and notice the lifting action of the other end. Now fold over as shown at Fig. 4, about 2 inches backwards and forwards several times until the folded portion will easily move up and down, and blow again. It will be seen that the flap will lift up and remain up while the air is directed on the plane. If a current of air is directed underneath the flap will vibrate only and act as a drag on the forward lifting of the plane.

Another experiment may be made with notepaper and cardboard to show the lifting effect of the curved plane. Cut out two pieces of thin cardboard and touch the edges with glue or seccotine; fold a piece of notepaper over to form an aerofoil. Next support the plane with cotton and blow directly on the front with a pair of ordinary bellows or direct the escaping air from a toy balloon instead, and observe the lifting action.

We have seen that the curved aerofoil is most suitable, and must now consider the length and width of the planes, or the aspect ratio; that is, the proportion of width or depth to length. It has been proven by experiment that a plane with a long front edge or entry and narrow depth is more efficient than one with smaller span and greater depth, and this is easily understood by glancing at Fig. 6. The air meets the long edge and is captured by the curved surface and directed downwards. A wide plane surface as suggested by the dotted lines would only be effective at the front portion, the rear would exert very little effect on the air which has already been deflected, and would give extra weight to no effect.

We may take it that the chief part of the actual work of supporting an aerofoil is done by the underneath portion of the plane, also that a plane with a large aspect ratio is necessary for speed and lifting power, and also that the angle of the aerofoil should be somewhere near 1 in 10.

Various mathematical calculations may be given to prove the truth of these theories, but as these involve a knowledge of trigonometry and are not really essential, they are omitted. It is a comparatively simple matter to vary the factors governing the fundamental principles of construction that abstruse mathematics may be safely left to theorists. The principles underlying the design of aeroplanes should now be understood.

Before commencing the design and construction of models, it will be as well to notice the lines along which the development of the modern aeroplane has run, and consider the types already proved to be conquerors of the air.

Although a considerable number of theories had been propounded and some few practical attempts had been made previously, it may be considered that the actual development of aeroplanes dates from the experiments of Otto Lilienthal, a German engineer, in the early nineties.

A lifelong study of the flight of birds led him to construct a three-pair set of wings, to be operated by his own hands and feet, the wings opening and closing like venetian blinds. He was unable to raise himself without the aid of a counterpoise weight, and then only at the expense of great muscular effort, so he decided that flapping flight was impracticable. His next

experiments were with fixed wings, which he used as gliders, and he was so successful that he devised a double-deck arrangement of wings, and was enabled to take longer glides.

He was in the habit of commencing a glide from the top of a hill some 250 feet high, and with a suitable wind could travel about 750 feet. Unfortunately, in 1896, he lost his life through encountering a current of air, which capsized his glider and precipitated him to the ground. His valuable experiments were continued in America by Herring, in England by Pilcher, and in France by Ferber, Pilcher losing his life a short time afterwards in a similar manner.

In America Herring and Chanute worked together and commenced a series of experiments, which furthered the double-deck style of glider. The Wright brothers also experimented with long bi-plane gliders, and arrived at the type of aeroplane bearing their name.

The first aeroplanes to be raised and propelled by motive power were invented by Langley in America, and Maxim, in England. Both of these distinguished inventors had to rely on the steam engine, and the excessive weight of the engine, together with the impossibility of carrying much water, prevented them from being raised more than a few inches above the ground. The Wrights were the first to adopt a gas engine to a large bi-plane glider.

BUILDS A BI-PLANE.

Ed. Ault, who is employed at the McCarty Buggy & Carriage Works, Iola, Kan., has almost completed a bi-plane, the idea and construction of which he has been working on for about three years past. The machine is thirty feet in length, eight feet in width, and seven feet in height. The uprights and ribs are of Washington spruce, and the framework of tough oak. The machine as it stands, without its cover which will be of linen sheeting, and without its propellers, rudder, engine and piano wire bracing, weighs 150 pounds. The ribs on both of the planes are concave, the hollow face being lowermost.

As far as the machine has at present been constructed it looks much like a Wright or Curtiss bi-plane, but there are several points about the Ault machine which are entirely original. It will not have rudders projecting far in front and back as the Wright and Curtiss machines have. The propellers will be in the rear, and a small plane directly in front of the lower larger plane will act as an upward and downward rudder. But the chief point in which the Ault machine will differ from all others will be in the method of maintaining its stability. The Wright machines keep their balance by the device of warping the ends of the planes, and the Curtiss by the aid of small planes placed between the ends of the larger planes.

MITCHELL MOTOR CAR CO. TO BUILD PLANES

Urging aeronautical experts to utilize the term "aerovehicle" in place of "airship" in describing heavier-than-air craft, Designer J. W. Bate has returned from a trip to Europe, where he made a study of the manufacture of aeroplanes. He announces the entry of the automobile company into the realm of aeroplane building and the receipt of the first order for ten aeroplanes to be delivered by the Mitchell-Lewis Motor Company to P. H. Greer, of Los Angeles, Cal.

Designer Bate is convinced of the practicability of transforming a portion of an automobile plant into an "aerovehicle" plant. Aeroplanes, in Mr. Bate's opinion, are to be classified as commercial and pleasure "aerovehicles" and he ventures the prediction that the first practical commercial application of the heavier-than-air craft will be in the carrying of government mail to districts that now are considered rather inaccessible. The sheet metal stamping facilities of the motor car plant appeal to the aerovehicle designer instantly, and may be adapted for the new industry with intelligence and little work. The trouble with most aeroplanes is their flimsy construction, too much at-

tention being paid to lightness by the sacrifice of stability. The majority of accidents to aeroplanes are due to the tangling of gears.

The new aerovehicle of the Mitchell factory will have features that aeronautical engineers will greet as not only scientific wonders, but will hail as the solution of many of the problems that hitherto have been obstacles in the path of the better development of the weight-carrying monoplane and biplane.

The aerovehicle power plant will be of a four-cylinder motor of light construction, stability being afforded by light aluminum fittings. The engine will have fitted to it a light, flexible clutch, so as to drive the propeller and enable the operator to engage the engine with the propeller at will and also to assist in starting the engine from the operator's seat. The aeroplanes will be a two passenger "aerovehicle," the weight of designing judgment being in favor of the dependability of a machine with two operators. With the chances for matters going wrong under the direction of a single operator being so obvious, it is the intention to reduce to the irreducible minimum the element of danger and disability in the heavier-than-air craft.

GLUE.

In meeting all demands of the trade there will be found to be a variety of demands made on glue. The cabinetmaker must have a grade of glue for his work which must show a good body test; should be light in color; must be a glue that does not dry too rapidly, yet not too slowly. The furniture maker demands a good grade of glue with a high adhesive test, also a good test for sweetness, and it must not foam while using.

It is generally supposed that for gluing wood pure hide glue is necessary, but this is not always the case. There are a great many glues for wood, mixed part hide and part bone glue, and there are some good grades of such glue being used for wood work and giving entire satisfaction.

Glue suitable as a cement for wood should be of an amber or brownish-yellow color, clear, dry and hard, with a glassy fracture, not too brittle, but somewhat elastic. Placed in cold water, it should swell and absorb considerable water without actually dissolving, though it remain in the water forty-eight hours. It should dissolve at a temperature of 145 deg. F.

A CERTAINTY.

The remarkable activity among motor car makers, especially the inception of new enterprises of the kind undertaken by regular carriage makers, makes it a foregone conclusion that there are gallons and gallons of the new Vanadium varnishes being used not only on the new work, but otherwise.

With the builder Valentine's Varnish is an article of faith based on work. With the strictly automobile man it had to be faith alone at first, but now he has found his faith made manifest in the work.

By a most happy combination of good thought and good fortune, Vanadium Varnish has been found to be perfectly adapted to motor car work. It is a proven good all-around article, but fortune did smile on Vanadium for automobiles.

Really, it is not so very usual in trade movements to find a very long established concern like Valentine & Company keeping abreast of every developing condition. It indicates remarkable vitality and youth.

NEW CATALOGUE.

Crandall, Stone & Co., (a corporation), one of the milestone concerns in the carriage trade, keeps fully abreast of new needs by adding automobile accessories of approved and tested merit as the need springs up.

All this is well shown in the new catalogue just out, wherein the "Pioneer" goods are fully described and well illustrated. Forty years of experience must verge on perfection.

A REALLY NEW DEPARTURE.

From the mechanical point of view, the Daimler Knight, Pieper and Lanchester omnibus constitutes almost a revolution in construction. The division of the structural framework into chassis and body has, in the new omnibus, become a thing of the past. The whole suspended parts of the vehicle are one homogeneous steel structure, with enormously increased strength for a given weight of material. The transmission of power from a single engine to two driving wheels, through balance gear—a feature of almost every automobile vehicle at present on the road—has given place to a system in which each driving wheel is directly propelled from an independent power unit through a worm and worm wheel. The interchangeable power unit system recently advocated, and adopted to some extent by makers of touring cars, has been carried in the new bus to a point far

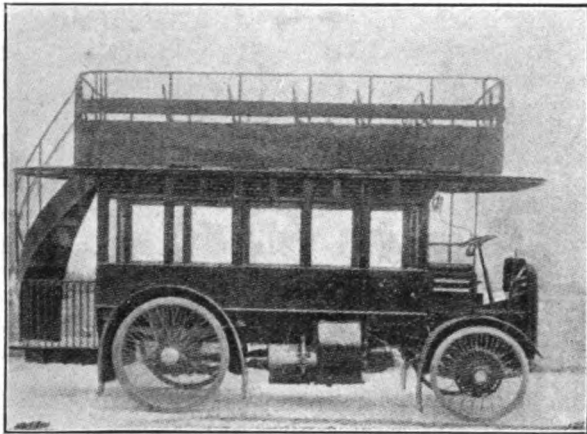
**Side View of Bus.**

beyond anything previously attempted. The units are entirely self-contained and are attached to the framework of the bus externally; they may be changed without the removal of any portion of the bodywork. In the power units themselves, no change-speed gearing is employed. A gasoline motor and an electric motor, directly coupled, and fitted with a magnetic clutch and brake, form the whole equipment of each power unit. The position, again, of the power units constitutes a departure from previous practice. They are arranged externally to the vehicle body, and small space is occupied by the whole of the driving mechanism—space not otherwise utilized beneath the seating level on each side of the bus body. The four-cylinder engines are of the well known new Daimler-Knight type, and the electromotors, or "dynamotors," are shunt-wound six-pole machines, which act alternately as motors or as dynamos, according to whether, on the one hand, their engines require assistance in order to propel the vehicle, or, on the other hand, the power of the engines is in excess of that demanded to overcome the resistance of traction. A storage battery is arranged under the driver's seat to take up, or give up, this excess energy as the gradient or conditions of the road may require. The reversing is done by the electromotors.

Other features of the new omnibus worthy of note are: the wire wheels, which are of exceptionally large diameter; an independent cooling fan, which is driven from the electric installation; the steering wheels, which are mounted on centrally disposed pivots carried vertically over the points of contact with the road; the front-wheel brakes—these are fitted in addition to a magnetic brake acting on each wormshaft; the exceptionally liberal length of the springs; the tubular axles; the separate spring suspension of each motor unit; and the ignition magneto, which is driven direct from the motor crankshaft.

Among the claimed advantages are: Increased ground clearance; lower floor level and lower centre of gravity; moderate wheelbase; smaller turning circle; less traffic congestion—as a result of the decreased overall length; brakes on all four wheels; ease of steering and control; ease in which power units may be

dismantled and replaced; engine stopped when vehicle is standing—the motor, being electrically started, renders it unnecessary to leave any engine running when taking up or setting down passengers; less wear and tear on tires; less wear on brakes; and silence of running.

As may be seen from illustration, there is no chassis frame in the ordinary sense, the frame being formed by the bottom or well of the body, which is built up of sheet steel rolled into a deep channel section. At the points of load application on the springs, cross members shaped and rivetted to the steel well are fitted, and these add the necessary stiffening at the points required. Torsional rigidity, to meet all winding and twisting strain on the frame, is insured by means of a large rectangular steel tube, which is securely rivetted to the two sides of the steel well under the driver's seat. This tubular member also forms the gasoline tank.

At each side of the sheet steel frame, and under the top horizontal webs or seat lines, the power units are fitted, and these, on the present bus, comprise two 12 H.P. Daimler-Knight engines, the crankshafts and frames of which are extended so as to accommodate the dynamotors, the whole forming complete and compact self-contained units. Each dynamotor is nominally rated

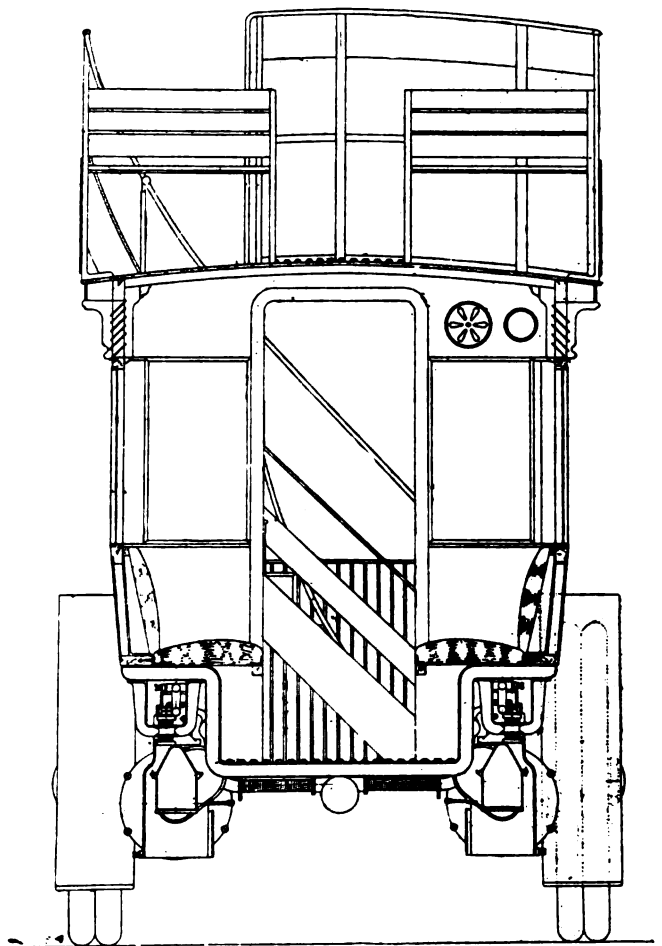
**Cross-Section of 'Bus Looking Toward the Rear.**

at 3 kilowatts, but has a "give and take" capacity of three to four times that rating. The drive from each power unit is transmitted through a worm and worm wheel to each rear wheel—no differential gear being fitted.

The maker has been enabled to use 40-inch diameter wheels on the front axles and 48-inch diameter wheels on the rear axles. Further, besides obtaining the great advantages due to large wheel diameters, the weight of the wheels has been reduced, and a larger factor of safety secured. The unsprung weights have been reduced to a low figure—that below the rear springs is stated to be under 10 cwt., and below the front springs about 5 cwt. The height of the platform (inside the body) above the

ground has been reduced to 27 inches, which dimension is from 5 to 10 inches lower than the majority of existing types; also, the ground clearance has been increased to 15 inches, against the 10½ inch minimum specified in the police regulations. The power units are slung in the track of the wheels; hence, their ground clearance does not enter into consideration; they are, however, nearly 12 inches clear from the ground.

Four separate methods of braking are available for use, and these are; (1) by moving the control lever on the steering wheel to the strongest field position, when the momentum of the bus is absorbed by charging the battery; (2) by a magnetic brake

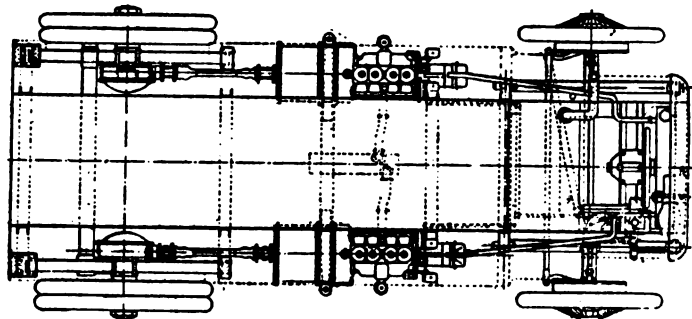

View of Chassis.

which operates on both cardan shafts and is actuated by one pedal, which also declutches the engines; (3) by a foot lever, which operates the brakes on the front wheels; and (4) by a hand lever, which also actuates the front brakes.

For the control of the bus, there are two levers placed on the top of the steering wheel; one is connected to the dynamo field-controller; the other is connected to the two engine throttles. For running in a forward direction, the two dynamotors are connected in parallel with the battery; the field regulation is controlled by a common rheostat. For reversing, the dynamotors are connected in series. The parallel and series positions are obtained by a single controller, the operating lever for which is placed within easy reach of the driver, but need not be touched by him until a change of direction is required.

The radiator is placed in front of the vehicle, and is connected to both engines, the circulating pump serving both units. The pump is driven by a ½ H.P. electric motor, which also drives a fan. The total unladen weight of the vehicle, including 5 cwt. of accumulators, ready for the road, is 3 tons 9 cwt.

A. L. A. M. ON NOMENCLATURE.

The A. L. A. M. has discussed words that have crept into the automobile business, which, in the opinion of many, were unfair to the trade as a whole. Such expressions as "pleasure car," for a machine to carry passengers, was considered pretty poor nomenclature.

The term "commercial cars" as applied to freight carrying automobiles, was considered a misuse of the term from the fact that all automobiles are commercial and practicable.

The general opinion seemed to be that in future, automobiles should be termed "passenger automobiles" and "freight automobiles."

NEW AUTOMOBILE LAW.

Governor Hughes has signed the Callan bill, providing for the registration of automobiles and the licensing of chauffeurs, a measure which it is estimated will yield an annual revenue to the state of about \$1,500,000. Automobiles of 25 horsepower or less are to be taxed \$5; between 25 and 35 horsepower, \$10; between 35 and 50 horsepower \$15, and \$25 for all other except commercial vehicles, which are to be taxed a flat rate of \$5. Chauffeurs are to pay annual license fees of \$5, and will be compelled to carry a license, containing their name, photograph and general description. The new law goes into effect August 1. After this year machines are to be licensed February 1.

OBITUARY

Moses Straus, president of M. Straus & Sons, Newark, N. J., prominent patent leather manufacturers, died at his country seat, Deal Beach, N. J., near Long Branch, July 19, aged 78. His death is ascribed to a general breakdown, due to his years. He was one of the oldest tanners of this country, being a pioneer in the Newark leather trade. He was born in Germany and arrived in the United States when he was 17 years old. Soon afterward he entered the leather business and founded his firm. Mr. Straus was a man of high character, esteemed and respected by all who knew him. He leaves a widow, two daughters and three sons, Lewis, I. T. and Benjamin, all of whom are of the tanning firm and who will continue the business.

Col. John Phillips, aged 67, died a his home in Ironton, O., from a complication of diseases. He was born in Lancaster, O., and served in the Civil War. He moved to Ironton in 1873 and was the head of the Phillips Buggy Works. He is survived by his wife and four sons.

William Lindemann, a well known retired wagon and truck manufacturer and a resident of Detroit for over half a century, died of paralysis that had made him an invalid for the past seven years. The deceased is survived by a widow and six sons, three of whom will continue the wagon and truck manufacturing business that the father established in 1869. Mr. Lindemann was born in Germany in 1846. His parents brought him to the United States when he was two years of age and the family settled in Detroit, where the deceased has since resided. Advancing years and failing health caused Mr. Lindemann to retire from business seven years ago.

Martin J. Smith, aged 57, of Lawrenceburg, Ind., a carriage builder, died at his home from injuries received while attempting to open a door at his home. When it did not swing readily Smith jerked the door with such force that it struck him, knocking him to the floor. He received internal injuries which proved fatal. A widow and four children survive.

John N. Kunkel, president of Kunkel Wagon Works Company, Baltimore, Md., died July 6. He leaves six sons and three daughters.

E. A. Daniels, president of the Pinneo & Daniels Co., one of the oldest wheel factories in the trade, died at his residence in Dayton, Ohio, July 19, from heart failure. Mr. Daniels was born December 26, 1839, at Franklin, Mass., He was married early in life to Miss Mary Kilburn, whose family lived near Boston. The young couple came to Dayton in the early fifties and Mr. Daniels entered at once into the business life of the city. More than forty years ago Mr. Daniels entered into partnership with Mr. Pinneo in the manufacture of hubs, spokes, wheels, etc., and the firm of Pinneo & Daniels became one of the solid institutions of the city. About fifteen years ago Mr. Pinneo died, but the old firm name remained unchanged. Mr. Daniels' son, H. R. Daniels, entered the firm some years ago and of late he had represented the Daniels' interest in the concern. Dr. Daniels is survived by his widow, two sons and a daughter.

BANNER COMPANY TO MAKE MOTOR CARS.

The name "Banner," which so long has been identified with the vehicle trade, will soon appear as the name of an automobile. Russell E. Gardner and others associated in the Banner Buggy Company have organized and incorporated the Banner Automobile Company with the following officers: President, R. E. Gardner; vice-president, Hugo Cartwright; department manager, Elmer L. Roninger. It is said that the company will manufacture a complete line of medium-priced cars. An output of 20,000 cars per annum is contemplated. A large manufacturing plant will be erected.

Trade News From Near and Far

NEW FIRMS AND INCORPORATIONS.

Louis Ruel, Pittsfield, Mass., has established a carriage shop. The William Berg Company, Omaha, Neb., capital \$10,000, to deal in buggies and automobiles, has been incorporated.

Inland Motor Parts Co., Chicago, Ill., capital \$2,500, to manufacture motor parts, incorporated by Fred C. Lindgreb, H. W. Corbett.

The Meridian Auto Co., Meridian, Miss., capital \$10,000, has been incorporated by Sam Meyer and J. T. Russell to manufacture automobiles.

The Razor and Joyce Company, of Greenville, S. C., has been commissioned with a capital of \$25,000 to do a general live stock and vehicle business.

The Jackson (Ohio) Spoke & Rim Co., has been incorporated with capital of \$3,000, by J. A. Howell, F. W. Jones, C. O. Evans and J. M. Robbins.

The Garth Motor Car Co., has been incorporated with a capital of \$400,000 by Geo. S. Patterson, H. A. Stahl, E. J. Thobaben, F. C. Carroll and C. P. Colley.

The Northwestern Wheel & Wagon Works, Bellingham, Wash., has incorporated. The officials are: C. L. Tomlinson, president; F. W. Whitford, treasurer.

Matthew J. Hansen, Inc., New York City, to manufacture wagons, vehicles, etc., capital \$10,000. Incorporators, Matthew J. Hansen, 142 W. 16th street, and others.

The Munsing Motor Car Co., to manufacture automobiles, capital \$500,000, has been incorporated by Wm. H. Bursmith, 76 W. 125th street, and others, of New York.

The Pelletier Aeroplane Co., New York City, to manufacture aeroplanes, motors, engines, etc., capital \$25,000, has been incorporated by H. E. Pelletier and F. J. Pierce.

The Daimler Import Co., New York City, to manufacture and deal in automobiles, capital \$300,000, has been incorporated by A. N. Jesbera, 15 Bainbridge street, Brooklyn, N. Y.

The H. B. Gray Company, to manufacture and deal in automobiles and motors, capital \$5,000, has been incorporated by H. B. Gray, H. G. Gray and others at Fort Plain, N. Y.

The Gotham Motor Car Co., New York city, to manufacture and deal in motors, engines, etc., capital \$25,000, has been incorporated by R. W. Schuette, Douglass Manor and others.

The Baker Sales Company, New York city, to manufacture and deal in automobiles and accessories of all kinds, capital \$10,000, has been incorporated by Wm. E. Baker and Leonard Veith.

The Balance Gear Light Vehicle Co., New York City, to manufacture vehicles, motors, engines of all kinds, with a capital of \$30,000, has been incorporated by W. E. McDonnell, 132 Nassau street, and others.

The Stephens-Cropley Company, Chicago; has incorporated; capital, \$25,000, to manufacture and deal in vehicles, engines, machinery, etc.; incorporators, George W. Stephens, Fred S. Cropley and William A. Conover.

Articles of incorporation have been filed by the Ritter Automobile Company, an organization which will operate in Madison Wis. The company is formed with a capital stock of \$25,000 to deal in, manufacture and repair autos and sell gasoline and oil engines. It will also make and store auto and road vehicles. The incorporators are H. R. Ritter, J. C. Harper and Homer Z. Webster.

New Wapakoneta Wheel Co., Wapakoneta, Ohio, has been organized and up-to-date buildings will be erected. The main building will be a one story brick, with power plant in the center, and will have 37,000 feet floor space. The officers of the

company are: Edwin Abe, president; C. T. Kolter, vice-president L. N. Blume, treasurer; John Tausch, secretary, and Ed. Trau, general manager.

A new corporation known as the Empire State General Vehicle Company, with a capitalization of \$100,000, has been organized to take over the electric truck business of the Rochester Railway and Light Company. The officers are: President, Robert M. Searle; vice-president, Granger A. Hollister; secretary and treasurer, J. T. Hutchings. The new concern will erect an assembling plant. It has secured the agency for the General Vehicle Company of Long Island City, and will carry a complete stock of vehicles, as well as every detail of equipment.

BUSINESS CHANGES.

The Brodesser Motor Truck Co., Milwaukee, Wis., has changed its location to Juneau, Wis.

Battin & Crist, dealers in implements and vehicles, etc., at Orient, Iowa, has sold out to Coffey & Irwin.

R. F. and W. M. Weygant, of Central Valley, N. Y., will transfer the main part of their business into an automobile repair shop.

As a result of negotiations the International Harvester Company has acquired practically all the stock of the Chatham Wagon Company, of Chatham, Ont., thus giving it control.

Thomas W. Williams, formerly of LaPorte, Ind., has sold his Michigan City Carriage works to Barney Switzer of South Bend, and has accepted a position with the Columbus (O.) Varnish Company.

J. D. Humbert, Marshalltown, Iowa, has decided to remove the business of the Grinnell Vehicle Company and the Iowa Manufacturing Company to Des Moines before many months and he will take up his residence there.

S. L. Dodds has bought the Hickman (Ky.) Wagon Factory and will have the same running full capacity as soon as some improvements are made. Besides interior improvements, he will erect another large building on the lots west of the office and build a switch from the railroad into these lots.

The firm heretofore composed of F. J. Muldoon and O. A. Schauss, doing business under the name of M. & S. Service, Kalamazoo, Mich., makers of signs and carriage painters, has been dissolved, Mr. Muldoon having severed his connection with the firm. Mr. O. A. Schauss will continue the business at the same location, 110-112 North Edwards street.

BUSINESS TROUBLES.

The Hibernian Bank of Chicago was named receiver of the Elgin Wagon Works, Elgin, Ill., capitalized at \$10,000, which was thrown into bankruptcy recently on petition of its creditors.

Margaret Shake has sued the Kentucky Wagon Works for \$2,250, alleging that her son, Oscar Shake, aged nineteen years, was injured in a boiler explosion at the defendant's plant on November 8, 1907.

W. G. Hirsig, A. E. Potter and E. C. Boykin have been appointed receivers for the Volunteer Carriage Company, Nashville, Tenn. The appointments were made on an involuntary petition in bankruptcy.

The Federal Court, Birmingham, Ala., has judged the Taylor Carriage Company, of that place bankrupt. The matter has been referred to Edmund H. Dryer, referee in bankruptcy. An involuntary petition in bankruptcy was filed against the company.

A petition asking that the Embree-McLean Carriage Company, St. Louis, Mo., be adjudged bankrupt, was filed in the

United States District Court. The creditors who caused the suit to be filed are Herman Nau, of St. Louis, the Conde-Neale Glass Company, and the Thompson & Protz Lumber Company. The petition sets forth that the carriage company owes Nau \$2,500, the glass company \$55.11, and the lumber company \$63.46.

J. L. Coxe, receiver of the Keystone Wagon Works, Reading, Pa., declared insolvent, has filed his second account which has been approved by the auditor. A number of claims found to be correct are allowed. They make a total of \$190,175.81, the balance for distribution under the account being \$22,043.22, allowing a pro rata share of .1159. The largest individual claim was filed by George Brooke, Jr., trustee as assignee, for \$148,772.09 and \$17,361.30 additional. On these claims the distribution amounts to \$17,243.68 and \$2,012.67, respectively.

A decision has just been received in a case that has been dragging through the courts for the past six or eight years. It is that of some of the stockholders of the Schad Wheel Company of Avoca, N. Y., which for some years manufactured carriage wheels and finally became bankrupt, in August, 1897, against the three men who purchased the factory and stock and continued the business. After the failure of the original company the property of the concern was bought at sheriff's sale by John H. Ellis and H. Wilmot Smith, who has since removed to Pasadena, California. These men put in a large amount of needed capital, purchased new and up-to-date machinery and equipment and by wise management they finally succeeded in placing the concern on a successful financial basis. The company has created a demand for its product among the manufacturers of carriages. The result has been that the business has not only yielded a reasonable return to the proprietors, but it has been a source of great benefit to the town. In January, 1903, more than five years after the failure of the original company, some of the stockholders of the defunct concern brought an action against the three men mentioned, alleging fraud and irregularity in the transfer of the property and claiming damages resulting from such transaction. Justice Foot's decision is a signal triumph for Ellis, Smith and Pettit.

IMPROVEMENTS—EXTENSIONS.

The Sibley Motor Co., at Detroit, Mich., has increased its capital from \$80,000 to \$150,000.

The Eller Wagon and Carriage Company will construct a new three story building at Houston, Texas.

An addition to its factory at East Third and Locust streets, Des Moines, is being planned by the Shaver Carriage Company. The addition will cost about \$20,000.

A permit for the erection of an addition to the Overland Automobile Company's motor factory at Indianapolis, Ind., has been taken out, the building to cost \$20,000.

The Regal Motor Company, Detroit, Mich., has broken ground for its new plant in Windsor's factory district along McDougall street. The building will be about 150x300 feet in dimensions.

The Hercules Buggy Company, of Evansville, Ind., will build more additions to take care of its business. W. H. McCurdy, president of the company, says business is now 25 per cent better than at was last year.

The contract has been let by Dodge Bros., Detroit, Mich., machinists and manufacturers of automobile parts, for their main building in connection with their new plant on Joseph Campau avenue, near Bismarck.

The Winton Carriage Co., of Cleveland, Ohio, has made additions to the plant which cover 200,000 square feet of space, 150,000 of which is to be used as an assembling room and the other 50,000 square feet as a foundry.

The Huntingburg (Ind.) Wagon Works has let a contract for the erection of two additional buildings to be used as a paint shop and a blacksmith shop. The former is to be 54x146 feet and the latter 41x146 feet, both of brick.

A site for a new factory in Long Island City has been purchased by the Ford Motor Company from the Pennsylvania

Tunnel and Terminal Company. It includes two plots, the corner of Jackson avenue and Honeywell street.

The General Motors Company will make extensive improvements on the Elmore factory at Clyde, Ohio. A new machinery building, 200 feet wide and 250 feet long, will be erected, making the main factory structure 660 by 300 feet.

Following the announcement by the United States Motor Co. that a Detroit plant would be built for the making of Sampson trucks, a building 1,050x150 feet is in process of construction near the plant of the Brush Runabout Company.

A building permit was issued to the Hudson Motor Car Co., Detroit, Mich., for a reinforced concrete factory at the northeast corner of Jefferson avenue and Conners Creek, to cost \$75,000 and an office building at the same location to cost \$25,000.

The Hannibal (Mo.) Wagon Co., which very recently leased the Anti-Friction Spiral Bearing Co. building, has installed new machinery in the building and is now operating Plant No. 2. This plant will be used principally for the manufacture of wheels.

Eastern capitalists have closed negotiations for the controlling interest in the Jonz Auto Company, Beatrice, Neb., and the company is to increase its capital stock to \$1,000,000. The company was organized a few years ago by N. E. and C. Charles Jones, and the latter invented the Jonz automobile.

The business of the Glen Wagon Company, at Seneca Falls, N. Y., is growing so rapidly that the capacity of the works is overtaxed to fill orders, in spite of the large additional buildings recently completed. The capital stock of the company is to be increased in order to secure the funds necessary to more than double the manufacturing capacity of the works.

With every modern facility and machinery for manufacturing wagons and carriages and for repair work, with ample floor space in their display rooms, Schueler Bros. are now occupying their new wagon and carriage factory and repository at Milwaukee, Wis. The building is entirely new and fireproof, has 4,800 square feet of floor space on three floors and a basement.

The capital stock of the Willys-Overland Automobile Company, Toledo, O., is to be trebled. The increase from \$2,000,000 to \$6,000,000 will be authorized at a meeting of the Board of Directors to be held soon. The new stock will be placed in the treasury and issued as the capital is required for use in the company's business. President J. N. Willys says it is only a question of time when the company's big plant at Indianapolis will be moved to Toledo.

The steady and continued growth in the distribution of Premier motor cars has influenced the Premier Motor Manufacturing Company, of Indianapolis, Ind., to enlarge the capacity of its factory at Georgia and Shelby streets, and already operations are under way which will almost double the present floor space and proportionately increase the production. The Premier company has purchased additional ground in Georgia street opposite the present plant.

The new factory buildings of W. S. Frazier Buggy Company, Aurora, Ill., will be entirely modern. Two of the buildings will be the same size and there will be two or three smaller ones. The total cost of the buildings will be about \$40,000. The buildings will be of brick and will be high and airy. It is hoped to have the structures completed in time for occupancy not later than November 1. The removal of the factory and the erection of the new buildings is made necessary by the recent settlement of the estate of the late Walter S. Frazier, Sr. Lincoln B. Frazier has purchased from the estate the stone buildings in which the factory proper is now located.

The prosperity of the Grabowsky Wagon Co., Detroit, Mich., is evidenced by the recently increased capital stock from \$100,000 to \$500,000. The company is now moving into its four story building, the cost of which, including equipment, is about \$150,000. All departments will be installed in the new factory within 30 days. The floor space and facilities afforded will practically quadruple the capacity of the company, demanding an in-

crease in the number of employes to a total of 800 to 1,000 men. It is expected that no less than 100 cars per month will be turned out in the new Grabowsky factory, which is located on the nine acre plot owned by the company at Mt. Elliott and the Michigan Central belt line.

Commercial trucks will be the kind of motor cars the Kansas City (Mo.) Vehicle Company will make a specialty of when it occupies its new building near Twentieth Street and Tracy avenue. Work on the new factory 128x200 feet, has already begun. "We will continue to manufacture horse-drawn vehicles when we get in our new plant, of course," says H. F. Gleason, manager of the motor car department, "but our specialty will be commercial motor car trucks. As soon as the new building is ready we will move from our present factory at Second and Main streets. In the new plant we will have about double the space we have here and we intend to double our capacity. At present we employ about seventy-five men in our factory and the force is to be increased to 150. We will put in about \$15,000 worth of new machinery."

PERSONAL.

Alfred C. Reynolds, one of the founders of the Reynolds Carriage Works, will leave for Ellisburg, Wash., to make his home.

The tenth annual outing of the Carriage and Wagonworkers' Union was held on August 7 at Walter's Emerald Park, New York City.

Plans are nearly completed by the Blacksmith's Union No. 209 for forming a branch union of carriage-smiths in Boston. The strike in Brocton is said to be settled except for final action on the wage scale.

Dale Pohlman, for several years manager of the Anderson Carriage Company's plant, has resigned his position and will move to Detroit where he will become associated with a large carriage factory.

O. A. Hook, who has been superintendent of the Elgin Wagon Works, since its beginning in Dundee, has accepted a position with the Pekin Wagon Co., of Pekin, Ill., and will act as assistant to W. A. Ebbert, who is now vice-president and manager.

The annual convention of the salesmen of the Durant-Dort Carriage Company, Flint, Mich., was a great success. Blue ribbons were in evidence everywhere throughout the city and the enthusiastic yell of the men who find a market for the famous Blue Ribbon output was heard wherever the salesmen congregated.

Manager M. A. Steele of the Henney Buggy Company and the Freeport Carriage Company was host July 14 to a party of branch office heads and officers of the Moline Plow Company, which latter company controls the two Freeport plants. Among those present were A. C. Barber, W. H. Masten and R. K. Baker, of Moline; W. E. Manning and J. E. Burbank, Kansas City; C. A. Cadwell, Sioux Falls; C. C. Trozell and F. N. Davis, Omaha; L. Lauritzen and H. M. Harrington, of Fresno, Cal.; J. T. Simmons, Dallas, Texas; W. H. Murphy, St. Louis, and F. T. Windle, of Moline. These gentlemen were entertained at lunch at the Brewster house and shown Freeport.

PROSPECTS NOT YET EFFECTIVE.

The contract was let for the Studebaker Brothers' carriage factory and display rooms, to be erected at a cost of \$49,000 on the corner of Eighth and L streets, Sacramento, Cal.

Michigan promoters recently submitted to Wichita Falls, Tex., a proposition to establish an automobile factory and the matter is being looked into by local business men, a committee of whom will leave soon for Detroit.

The building of Anniston (Ala.) buggies for the wholesale trade by the Hale Buggy Company is almost an accomplished fact. It will be in two or more weeks. The necessary machinery together with a large amount of material has been bought

and is expected to arrive early in August and the business will be set going.

Preparatory to the erection of a permanent factory in Paducah, Ky., the Mutual Wheel Company, of Moline, Ill., purchased a piece of property in Mechanicsburg and the work of erecting the buildings will be started at once.

Ground will be broken in San Antonio, Tex., for a large six story building to be occupied by the Commercial Car company of San Antonio, a concern which will manufacture auto trucks, delivery wagons and passenger cars for rural traffic.

Berton B. Bales announced that the American Automobile Manufacturing Company of which he is the president, will establish a factory in Louisville, Ky., to cost \$125,000. Offices have been opened and members of the firm are negotiating for the purchase of a site.

Nashville, Tenn., is shortly to take rank as one of the leading manufacturers of automobiles in the United States. This will result from the opening of the big new plant of the Southern Motor Works, and the placing on the market in large numbers the Marathon automobiles as a Nashville product.

If the city of Pueblo, Colo., will offer certain inducements in the shape of a suitable site, W. R. Andrews, of New York city, declares that he will erect and operate a factory in Pueblo to manufacture of his patented device, a spring automobile wheel that he expects will do completely away with the inflated rubber tires now in use.

A conference at the Board of Trade, Fort Worth, Tex., will confer with Warren Heaton, of Neosho, Mo., concerning the removal of his wagon factory to Fort Worth from Neosho. A proposition was made by Mr. Heaton and a counter proposition offered. It is understood that Mr. Heaton wants a factory site of two acres convenient to a railroad, the subscription of \$50,000 to the stock of the factory and a guarantee of the cost of removal.

FIRES.

Robert Elder, Toronto, Canada, suffered a \$1,000 fire loss. Humphrey & Son, Buffalo, N. Y., sustained a \$2,000 loss by fire.

A. R. Tomlinson, Charleston, S. C., suffered a complete fire loss.

The United Carriage Co., Portland, Ore., sustained a complete loss by fire.

The Bode Wagon Works, of Cincinnati, O., sustained \$100,000 loss by fire.

Warner Pole & Top Co., Cincinnati, O., suffered a \$50,000 loss by fire.

G. S. Dolan, Cumberland, Md., suffered a fire loss of \$3,000, partly insured.

John Guedelhofer, carriage and wagon maker, Indianapolis, Ind., sustained a \$3,000 loss by fire, fully covered by insurance.

SEND YOUR CATALOGUES.

A request has been received from an American consulate in Latin America for catalogues, in Spanish or French if possible, for the use of a carriage maker who makes inquiry especially in regard to the purchase of the following articles of American manufacture: Patent axletrees, one-half patent square bolts or king bolts, carriage springs, screws, carriage carpets or mats, paints, varnishes, carriage lamps, rubber for wheels with or without wires. The party in question would probably be interested in the following kinds of machines also, which are to be seen in use in his establishment: Machines of hand and steam power for bending tires, rimming or shoeing wheels, making spokes, notching and making sockets for spokes in hubs, setting rubber with or without tires, piercing iron, threading nuts and ends of patent axletrees with screw-thread right and left. The "Victoria" is the common type of carriage for public use, but two-wheeled carts are common for private use.

RETAIL METHODS CAN BE IMPROVED.**Big Concerns Take Up Approved Systems to Lessen Their Costs and Increase Selling Capacity.**

The importance of the application of sound principles and of using correct methods in the conduct of business is generally recognized. Whether the concern is large or small there must be the avoidance of unbusinesslike practices coupled with the wise management which normally is the prime condition of success. One service that large corporations are doing is impressing the necessity of having the best methods in every department. They are indeed notable for making marked advances in the adoption of progressive methods, the carrying of organization and detail into every part of the business and the infusing of an energetic if not strenuous spirit among all who are charged with any responsibility for results in their special fields of effort. In their practice there is an opportunity for merchants and manufacturers occupying much less conspicuous places in the commercial world to learn something of their methods and to emulate the painstaking care and system with which the management endeavors to have each department of activity directed as wisely and as profitably as possible. This implies an administration everywhere in accordance with the highest ideals of business and making an adequate financial success. Many small houses would do well to sit at the feet of the great concerns and learn to exercise similar care in the transaction of their own business, even though the difference in conditions would require a modification of the methods employed.

There is no doubt that many merchants and manufacturers excuse themselves from giving proper attention to their business methods on the ground that the house is a small one with only a limited trade. Their idea seems to be that what would be gained by small economies, by a better system, by a more vigorous and up-to-date prosecution of business would not greatly count in view of the comparatively moderate volume of transactions and the small extent of the enterprise. All these things, they say, practically, if not in words, are very well for large concerns, but are not worth while in such a store as mine. They thus unconsciously afford a modern illustration of the man who was entrusted with a comparatively small amount for investment and use, and because it was not a larger amount did not attempt to do anything with it. It is undoubtedly true that the smaller merchants of the country in every branch of business are less careful about their methods and less energetic in pushing their trade than are the larger houses. It would not be just to say that we have here a reason for the small business of these merchants who are negligent in regard to their methods. It would, however, be safe to assert that good methods in a small concern are important factors in achieving success. The merchant who has an easy-going or slipshod way of conducting his store is failing to follow the path that leads to larger business and better profit. If he is not faithful in taking care of his small business it will be owing to good luck rather than good management if he enjoys the satisfaction of having a growing trade and an increasing profit.

Every department of the business furnishes a field in which this principle may be applied and of the difference very frequently found in the practice of large and small houses respectively. Large concerns, for example, are exceedingly careful in the purchase of goods, and see to it that they are advised in regard to the market, and that goods are bought on the most advantageous terms available. Thousands of retail merchants give little attention to this department of their business, in which—if they adopted better methods—they might save 5 or perhaps 10 per cent. In a well-ordered manufacturing establishment it is a recognized principle that time is money, and there must be no unemployed workmen or idleness in working hours. It would be waste, and expensive waste. Good money has to be paid for that time and a way must be found to turn it to profitable account. If this cannot be done the workman is let go. One of

the problems in the retail store is making practical use of every minute of the time and so arrange things that employes shall always have something to do. Large houses have detailed methods carefully elaborated for keeping track of the volume and course of business, so that those in direction of it way have figures and records which will guide in making and carrying out plans, thus enabling them to utilize past experience and have a light cast on the probable future course of things. Many a smaller merchant is content to shuffle along without this help in anything like adequate detail, relying too much on general impressions and vague recollections. Other illustrations applying to various departments of the business, such as keeping tab on the work of salesmen, the adoption of good methods to secure promptness and efficiency from employes, and the employment of a system reaching out in various directions to make sure that the best service will be given to the public, will readily occur to our readers as enforcing the principle that the smallness of a business does not justify carelessness or unbusinesslike methods.—Iron Age-Hardware.

USE THE GOOD SUGGESTIONS.

Don't lose a good suggestion, use it. Thousands of business men to-day are neglecting to make use of the various good suggestions which come to them from various sources, merely by neglecting to make use of them.

They subscribe to trade papers, read something they know would be good for them to try, and then neglect to put it into operation.

They talk to a traveling salesman, and he tells them all about what some other dealer he calls on is doing along certain lines, and it looks like the same plan would succeed in their own place of business, but the plan is never put in operation merely because it is easier to float along in old channels than to try out the new ones.

A good suggestion comes from a customer, and it at once appeals to the dealer, but other matters crowd it out of the mind, and it is soon lost.

The woods are full of good suggestions, but it takes effort to apply them, and they must be applied in a thorough manner before any benefit can be derived from them. Get busy, and do a few of these things. You will never miss the time it takes if you will but use the time that would otherwise be wasted.

A TALE.

There was a man of modest means,
But inclinations gay,
Who sold a corner lot and bought
A motor car one day.
He closed his business up to ride
Within the big machine,
And parted with his diamond ring
To buy the gasoline.

Before, along the country roads
The sumac lit its fires,
He put a mortgage on his house
To purchase rubber tires;
And next he auctioned off his beds,
His tables and his chairs,
To give the car a coat of paint
And make some slight repairs.

But speeding in the early dusk,
Without his lamps alight,
A man in blue and brass appeared
And stopped his dizzy flight.
He didn't have a single cent
To pay the fine imposed;
They took the auto for the debt,
And so the tale was closed.—The Road.

Recently Granted Carriage Patents

Tire Fastener. Ruric W. Jordan, Boston, Mass., assignor to Jordan Demountable Rim Company, Boston, Mass. No. 963,048. Patented July 5, 1910.

The combination with a wheel, of a rim comprising inner and outer sections, the inner section being secured to the felly, and

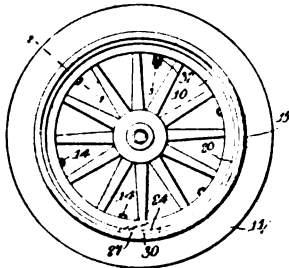

the outer section having slots along one of its edges, and an expansible ring on the outside of the inner section, and having teeth entering the slots.

Canopy Top for Vehicles. Charles E. Walters, Detroit, Mich., assignor to Michigan Steel Boat Company, Detroit, Mich. No. 963,098. Patented July 5, 1910.

A canopy top for vehicles, the combination with a flaring bow, an inclined brace member detachably engaging the bearing on

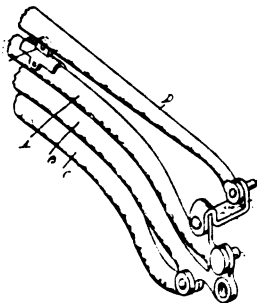

the flaring portion of the bow, and an offset bearing on the lower portion of the bow for engagement with brace in collapsed position.

Vehicle Brake. Randolph N. Martz, Frederick, Md. No. 963,608. Patented July 5, 1910.

A brake including a brake beam slidable backwardly and forwardly, a pulley carried by the brake beam and located in rear,

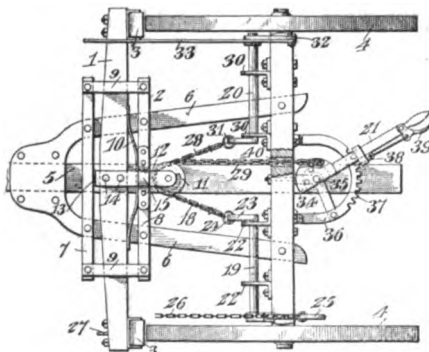

spaced transverse rock shafts located in rear of the pulley, a rear operating lever, and a chain passing around the pulley and having portions extending to the rock shafts and to the operating lever, whereby when the brake is applied at either side of the pulley, the chain at the other side will be held fast.

Whiffletree Connection. James H. Whan, Mertilla, Kan. No. 963,411. Patented July 5, 1910.

A whiffletree connection consisting of a straight plate formed

with a centrally arranged circular opening and with oppositely disposed communicating notches extending longitudinally of plate, and a second plate having its ends bent longitudinally in opposite directions and its central portion formed with oppo-

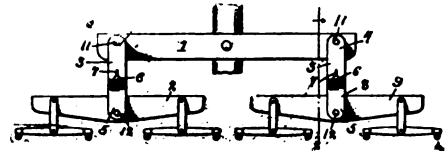

sitely disposed transverse notches to form between them a connecting neck, the second plate being adapted to pass through the notches in the first plate and neck being adapted to enter circular opening, whereby the ends of the two plates will be oppositely disposed in spaced relation.

Pneumatic Tire Protector. Gustave Vergote, Marshall, Minn. No. 963,667. Patented July 5, 1910.

A protector for pneumatic tires comprising a channeled cover embodying a tread portion having scalloped side edges present-

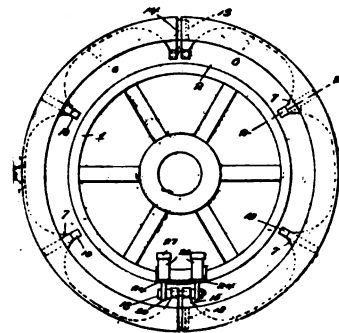

ing alternately arranged recesses and spaced lateral arms at each side, flanges extending laterally from tread portion and covering recesses and partially covering the arms, and clamps extending transversely beneath tread portion and arms and having spring fingers terminating adjacent to and beyond the ends of the arms to bear against the sides of the tire.

Armored Tire. William H. Enyon, Cleveland, Ohio, No. 963,882. Patented July 12, 1910.

An armored tire, comprising a sheath having embedded therein a flexible metallic armor consisting of a main body portion

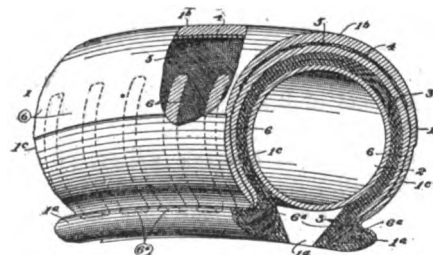

extending throughout the tread portion of sheath and provided with portions of substantial width and separate from each other disposed in the sides of sheath.

Vehicle Lamp. Irving H. Atwood, Amesbury, Mass. No. 965,551. Patented July 26, 1910.

A lamp, a curved or C-shaped piece adapted to be supported horizontally in the lower portion of the casing or lantern of the lamp, the piece being provided with longitudinal slots and with slots connecting one end of longitudinal slots with the lower edge of the piece and further provided with recesses extending

from the slots connecting with the lower edge of the piece under the longitudinal slots, whereby substantially longitudinal tongues are formed integral with the piece and adapted to be

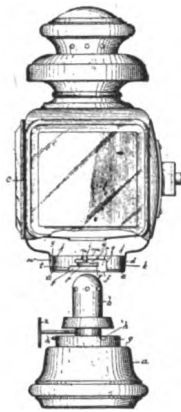

pressed downward into the recess and to spring upward therefrom; and a font provided with studs adapted to be moved into the slots over the tongues.

Vehicle Spring. Door R. Close, Chicago, Ill. No. 963,870. Patented July 12, 1910.

A vehicle spring structure comprising in combination two parti-elliptical springs, a coiled spring interposed between vertically substantially aligning portions of springs, a scroll extension of one of leaf springs extending beyond the end of the other, and means for checking the recoil of the second member comprising a substantially laterally rigid connection between the

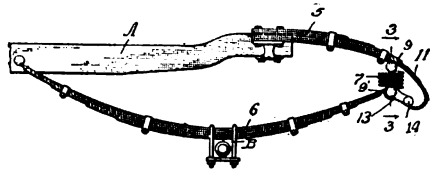

scroll portion and the end of the opposite leaf spring to which the coiled spring is connected.

Tire and Rim Lock. George J. Fanner, Cleveland, Ohio, assignor to the Fanner Mfg. Company, Cleveland, Ohio. No. 964,152. Patented July 12, 1910.

A vehicle wheel, detachable rim, means for movably securing

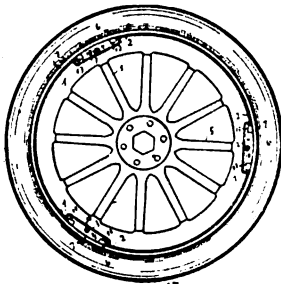

rim to the felly of wheel, the means comprising a toothed rack mounted on felly and pivoted members adapted to be engaged by toothed rack and to engage rim.

Wheel. Mason J. Clark, Newark Valley, N. Y. No. 964,215. Patented July 12, 1910.

In wheels, an inner rim; two side rims mounted over the in-

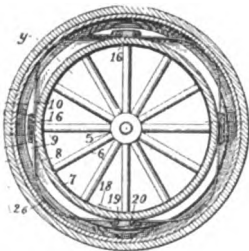

ner rim, forming a groove between them, and having horizontal slots in them; semi-elliptic springs mounted in the groove and having at each end a pair of rollers fitted to play in the slots;

a cushion located in each end of each slot, the length of the slots being proportioned to engage the rollers at one end in going forward and at the other end in going backward; and a stiff outer rim secured upon the springs at their midway portions.

Resilient Tire. Isaiah O. Wilson, El Toro, Cal. No. 964,727. Patented July 19, 1910.

A resilient tire, the combination of a felly, a metallic rim applied thereto and provided at its two edges with outwardly extending flanges, the middle portion of the rim being pressed outwardly to form a hollow annular rib, a plurality of resilient

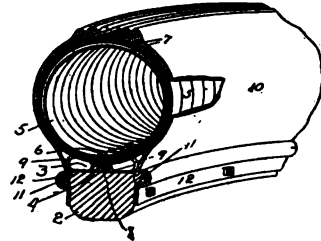

strips each of which is bent into a substantially circular form and the two ends thereof caused to overlap, bolts securing the overlapping ends of the strips to the annular rib and holding the strips against the outwardly extending flanges at the edges of the rim, nuts applied to the bolts and received within the hollow rib of the rim, and an outer casing inclosing the resilient strips and secured to the felly.

Tire Heater. Uno H. Laurin, Cleveland, Ohio. No. 964,795. Patented July 19, 1910.

A tire heater comprising a support, a fuel supply chamber mounted thereon, a hollow spheroidal member mounted on the

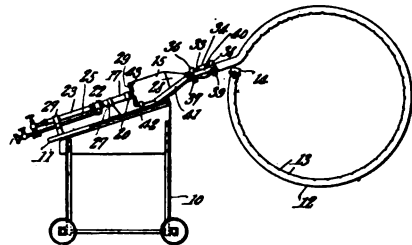

discharge end of the fuel supply chamber, a tube into one end of which the member extends, a burner connected to the other end of the tube, and means for holding the spheroidal member and the tube against endwise separation.

Spring Wheel. John Lee, Oelwein, Iowa. No. 964,979. Patented July 19, 1910.

A vehicle wheel comprising a spoke rim having flanges on its sides, one of the sides being removable, an outer sectional rim having its sections arranged between the sides of rim and adapt

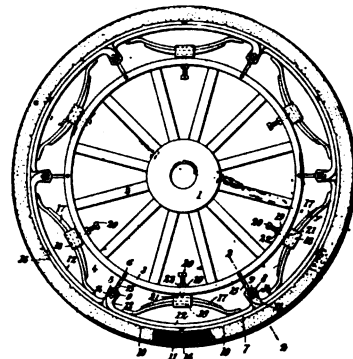

ed to move radially, guides located upon the sections, resilient yokes carried by the sections and adapted to extend from one section to the adjacent section, means for pivotally connecting the adjacent ends of pairs of yokes, means engaging the guides, and resilient shock absorbing means between the yokes and spoke rim.

Elliptic Spring. Harry Jeffrey, Louisville, Ky. No. 965,191. Patented July 26, 1910.

An elliptic spring, comprising in combination a primary fundamental plate formed with bent angular ends, and a secondary

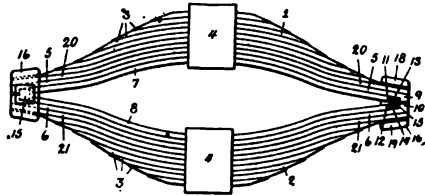

fundamental plate placed against the primary fundamental plate and formed with straight square ends and shorter than the primary fundamental plate so that its ends lie at some distance within the angular ends of primary fundamental plate.

Automobile Wheel. Charles Rasmussen, New Haven, Conn., assignor of one-half to Paul W. Steinbeck, New Haven, Conn. No. 965,539. Patented July 26, 1910.

An automobile wheel, the combination with the felly, tire and clencher rim, a series of rotatable locking cams carried by the

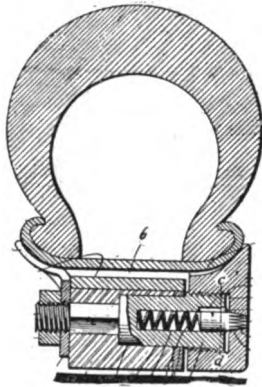

felly and adapted to engage with the clencher rim, a locking plunger extending outwardly into each cam for locking it against rotation, and means for supporting the plunger and holding it against rotation.

Rim of Wheels and Means for Temporarily Securing a Pneumatic Tire Thereto. Andre Michelin, Paris, France. No. 965,593. Patented July 26, 1910.

A vehicle wheel rim constituting a seat for a tire and providing at one side with a tire retaining edge of greater diameter than the rim and at the other side with an annular channel of

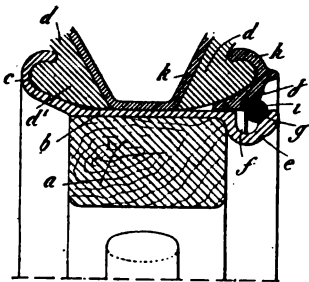

less diameter than the rim, an annular seat of greater diameter than the channel formed in the rim adjacent to the channel and in a plane on the opposite side of the channel from the wheel, a ring fitted to removably engage rim and the tire thereon, an annular seat in ring of greater diameter than the wheel rim and lying in a plane intermediate of the planes of the channel and seat in the rim and an inextensible endless locking ring adapted to rest loosely in channel when not in use and to engage both of the seats when in use for locking the tire on the rim.

Never attack whole bodies at a time, whether they be the daughters of Eve, or the sons of Adam. It is imprudent as well as unjust to attack them by the lump.

A NEW TYPE OF CABRIOLET.

The chassis this body is mounted on is a 12-16 Renault, and the idea of getting out this body was to provide a car for a gentleman driving himself, which would either be a touring car and still be a flush sided body and yet give full protection against the elements, also to get as roomy a body as possible without any great weight. It will be noted that the body is all in one compartments, there being only central doors, access being gained

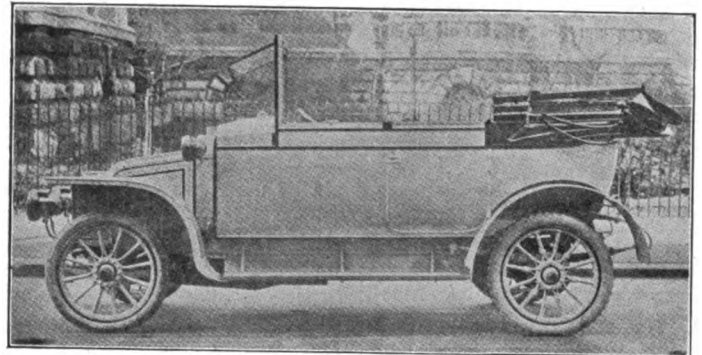

to the driver's seat by folding up the seat next to the driver; by this construction one set of doors is saved and consequently a great amount of weight, the body thus being a mere shell.

The landaulette head is covered with imperial leather enamelled on the inside instead of being lines, and the hoop sticks are all polished; this also saves considerable weight. Another feature of the body is that the driver's seat is adjustable to suit the length of legs of any driver.

THE WESTINGHOUSE IDEA.

The electrical expert, in conjunction with others, has devised, rather than invented, a spring that is to make the air tire unnecessary. It is to be put on the market soon according to report. In a recent interview the inventor declared his belief that the new spring would bring in an age of solid and cushion tires to replace the pneumatic tire, and second, expressed his acknowledgment to "a doctor, a clergyman, a mechanic, and a little engineer," as the originators of the idea that he has since developed and adopted.

WHAT THEY MAKE.

A year ago the Cadillac Motor Car Company, Detroit, Mich., was purchased by the General Motors Company for a price approximating \$4,750,000. The Cadillac Company has just closed its books for the fiscal year. Net profits were slightly in excess of \$3,000,444, or about 63 per cent on the amount paid for the plant, which in itself was considerably more than the actual amount of cash invested by the original company.

RECENTLY EXPIRED PATENTS OF INTEREST TO THE VEHICLE INDUSTRY.

- Patents Expired June 13, 1910.**
 - 499,288—Vehicle Running Gear. Luther J. Ewell, San Francisco, Cal.
 - 499,340—Vehicle Shaft. Josiah Kuykendall and William F. Kuykendall, Cookeville, Tenn.
 - 499,477—Holdback for Vehicles. Charles A. G. Swasey, New Bedford, Mass.
 - 499,514—Vehicle Wheel. James Buchanan, Indianapolis, Ind.
 - Patents Expired June 20, 1910.**
 - 499,793—Wagon. Marcus W. Montgomery, Chicago, Ill.
 - 499,830—Dumping Wagon. Lewis Helgs and George C. Coover, Mechanicsburg, Pa.
 - Patents Expired June 27, 1910.**
 - 500,154—Vehicle Spring. Levi Pentz, Canton, Ohio.
 - 500,283—Vehicle Shaft. Anton Friedmann, Jr., Cincinnati, Ohio.
 - 500,188—Vehicle Brake. Abraham Bruegger, Muskegon, Mich.
 - Patents Expired July 4, 1910.**
 - 500,578—Wheel. Franklin C. Hockensmith, Irwin, Pa.
 - 500,602—Vehicle Pole. John H. Osborne, Union City, Ind.
 - 500,689—Driving Wheel. George D. Munsing, Minneapolis, Minn.
 - 500,789—Spring Seat for Vehicles. John A. Alexander, Ardmore, Ind.
- The above lists of patents, trade marks and designs of interest to our patrons are furnished by Davis & Davis, solicitors of American and foreign patents, Washington, D. C., and St. Paul Building, New York City.

WHO INVENTED THE "PNEUMATIC."

A proposal to erect in Edinburgh a memorial to the inventor of the pneumatic tire has given rise to some dispute as to who was the real inventor. This is not the first time that a dispute has arisen as to the real author of an important invention or discovery. The fact is that a really distinct invention is not, in its earlier stages, a simple matter, however simple and commonplace it may appear to the general mind after its development and widespread use.

Such being the condition, it may be asserted that a really new article of utility is seldom developed by a single mind, but is the result of co-ordinated effort on the part of the inventor himself, of engineers and factory superintendents who assist in developing it, of his patent attorneys, the patent office examiners of the manufacturers who ultimately undertake its production, and of an indefinite number of users of the article. Every man of a practical turn of mind, who takes up the use of a newly invented article is liable to make some suggestion bearing upon its possible improvement, or its better adaptation to its intended uses, to the end that as long as the article remains in demand, each year's output of it may possibly be better than the preceding types. Many of the improvements so suggested are likely to be covered by patents—often in the name of the original inventor—but others, relating merely to details and not to new principles of invention, are utilized as part and parcel of the original patent.

To take the pneumatic tire, Robert William Thomson, while the first patentee of such an article, cannot be claimed to have produced a practical article of commerce. His aerial wheel was regarded simply as an interesting novelty, for the world was not ready yet for pneumatic tires, and Thomson and his patent were soon forgotten. Dunlop's pneumatic tire brought out at a time when the public mind was more receptive, lead to more practical results, but his invention disclosed no principle not anticipated by Thomson, and hence patent protection could not be claimed for it. The patents under which the really successful pneumatic tires have been made did not relate primarily to the principle of an air cushioned wheel, but to details of attaching these cushions to the wheel rim, and holding them in place.

Credit is due both to Thomson and to Dunlop for their study and application to the subject of rendering vehicular traffic more comfortable, but there is not being made on earth to-day any tire, the shape or means of attachment of which can be traced to any suggestion made by either of the gentlemen named. The Dunlop company early in its career dropped the Dunlop invention in favor of tires distinctly different, and to-day the tires made by that important concern are not even the same as were covered by various patents which the company acquired as development was made in the tire art.

The standard automobile tire to-day was protected in England by the patent granted to Bartlett. The tires made under this patent were developed year by year until they became the modern "clincher" tire, and it is informing to consider that the tire section of the present time has been a gradual outgrowth from Bartlett's specification. The purpose of this article is not to claim preeminence for any particular inventor in respect of the pneumatic tire, but to point out that the standard type of tire to-day is not the work of any one man, but of countless workers and students in the tire field.—India Rubber World.

BRITISH SUPPLIES MANUFACTURERS TO ORGANIZE.

Patterned after the A. L. A. M., the British manufacturers of automobiles and automobile accessories and supplies is in process of formation. In addition to the makers, the organization will include agents, and the main purpose of the body will be to prevent concessions from the list prices of the trade. During the past two years the tendency of fierce competition has been to force agents to divide commissions in order to get business.

TORPEDO AND SUBMARINE.

We thought the "torpedo" would have to develop something more after its kind, and sure enough our German friends have thought out the conclusion that a torpedo is something that

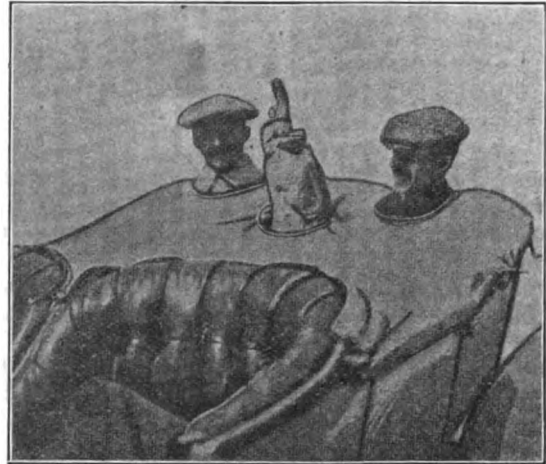

does business in submarine localities, so we have a submarine type of motor car attachment which we take the liberty to reproduce as a contribution showing how far an original freak idea may be amplified. The two Herr Barons shown in the picture look dust-proof, if not so very picturesque.

\$20,000,000 CAPITAL FOR THE B. F. GOODRICH COMPANY.

A special meeting of the shareholders of the B. F. Goodrich Co., Akron, O., has been called for August 24, for the purpose of increasing the capital stock from \$10,000,000 to \$20,000,000. The increase is to be 7 per cent. cumulative preferred stock, the existing capital to continue to be common stock. It is the purpose of the directors at once to declare a stock dividend of \$5,000,000 in preferred shares at par, and the balance of the increase in capital (\$5,000,000), before being sold elsewhere, will be offered to the stockholders of the company at par, pro rata. Arrangements will be made for the listing of both preferred and common shares on the New York Stock Exchange. Recent newspaper reports have mentioned quotations for Goodrich stock as high as \$325 for \$100 shares.

WELDING SPRINGS.

When it is not cheaper to buy a new spring, here is a way of making a weld: To prepare the spring plate, upset the ends, punch a small hole with a sharp-pointed tool, (to save stock), one quarter inch from end. Cut out with sharp chisel and bend the two parts down in opposite angles a little. Then fuller the scarf, leaving outer edge thick and forging a thin lip on inside of both ends. When thus prepared, heat and lock the four scarfs in together and hammer on flat surface, and then on edge. Now pin the thick outside edge which will stretch around and lock the four parts tightly together.

The fire should be clean, with small sides, and covered with a thin plate of iron, while catching heat. Use a small quantity of borax, and never overheat. Let no coal touch the spring. A round edge flatter will make a better weld than the hammer. Fit spring plates with clamp tongues; holding a few seconds and bearing on ends over horn of anvil will give proper set.

Temper with oil and have spring just hot enough to make oil blaze. Lay down in the air, or heat to a very dark red and dip whole plate in oil vat ten seconds. In either case, the spring will stand usage better where it is mended than anywhere else. This is the result of thirty years' experience.

IMPROVED TWO-CYCLE ENGINES.

Experimenters in Europe Work Out Problem to Get More Applied Power to the Stroke.

There are features of excellence about the two-cycle engine that make it an interesting proposition to the carriage builder who has to take such parts into consideration. The defects of the engine are well enough known not to need much comment. It seems that the careful experimenters in Europe have taken the time to work on the problem and have changed the arrangement of valves so as to get more applied power to the stroke.

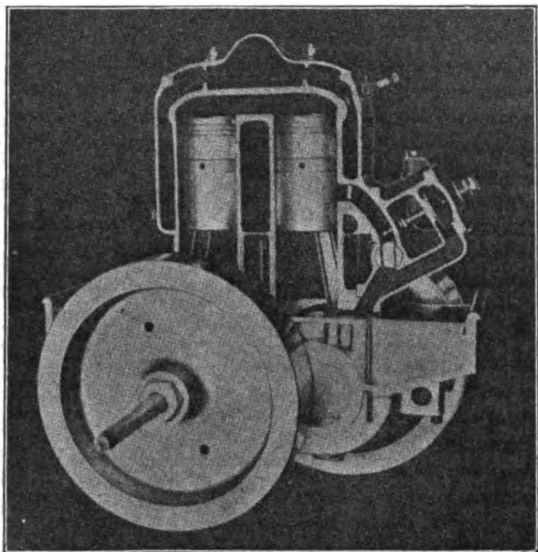

Sectional View of the 25 H.P. Valveless Engine Showing Carburetor and the Water-Cooled Space Between the Cylinders.

Illustrative of this point we find in *The Motor*, an energetic foreign periodical, two phases of this subject of much interest. One is the account of a perfected engine, the other the suggestion of an engineer for an improvement in valve arrangement.

Reversal of the direction of motor of the car is secured in the orthodox manner, that is, through the medium of an intermediate shaft in the gear gearbox. The engine is placed forward under the bonnet, and thus is completely accessible, while, being short in length, no less than 8 ft. 6 in. body space is available on a 10 ft. chassis.

The two pistons are in parallel vertical cylinders connected by a common combustion chamber, so that the cylinders and combustion chamber form an inverted U. The two pistons, therefore, drive down together, each connected to its own crankshaft, the crank discs having single helical teeth cut upon their peripheries, and the two being geared together. On the upward stroke, air is drawn through the air disc which, in being lifted from its seat, also lifts a tapered needle from the gasoline orifice in the throttle passage where a saturated mixture is formed. On the downward stroke the air is compressed below the pistons in the base chamber, and, near the bottom of the stroke, the inlet port in one cylinder is uncovered by the piston, the air passes from the base chamber through the throttle passage, intimately mixing with the saturated mixture and then, entering the cylinder, drives before it any residual exhaust gases which pass out through the exhaust port in the other cylinder, the exhaust port being opened about three-quarters of an inch in advance of the inlet port opening. The upward movement of the piston compresses the charge ready for firing, and air is drawn into the crank chamber for the next cycle of operations. Thus each downward stroke is a power stroke and each upward stroke is an induction stroke in the base chamber, and both pistons act simultaneously. Consequently there are only half the number of impulse strokes that would be given by a four-cylinder engine of the four-stroke cycle type. and the question at once

arises as to why the engine should pull so well at slow speeds. The first reason that would actually be advanced is the total mass of flywheel, for there is a flywheel on each crankshaft. But, quite as important is the fact that the carburetion is always equal and the charges are, therefore, regular in quality at all speeds. A great advantage possessed by the valveless engine over other two-stroke cycle engines is the fact that the baffleplate is the water-cooled division between the two cylinders and not a plate on top of the piston to get hot.

Lubrication is effected by a distributing plunger pump forcing oil to each moving part in turn, and as no gasoline is drawn into the crankcase the lubricating oil is not affected, neither is there any chance of the charge being fired before it enters the cylinders. Control is brought to a single lever above the wheel, this lever being used to operate the throttle.

The Proposed Two-Cycle Engine.

The advantages of the two-stroke motor are known. It has a more uniform torque than the four-cycle engine. To compare the two types it is necessary to remember the respective functions performed. In the four-cycle engine a complete and separate stroke is devoted to a single purpose—(1) induction, (2) compression, (3) firing, and (4) exhaust, giving an impulse stroke in each cylinder every two revolutions of crankshaft. Four cylinders must be used to get a constant turning effort. This is all done with two strokes in two-cycle engines. Often each stroke is halved to fulfill its two purposes, so that the four phases are completed in one revolution. If crankshaft speed and cylinder bore were equal in both cases, the two cycle might develop twice the power of the four-cycle, and many now expect it to. The error is in thinking the actual stroke has the same effective value as the four-cycle. It hasn't.

Fig. 1 illustrates this. The piston is shown at bottom of effective stroke. At that point the exhaust port in cylinder wall begins to be uncovered by the piston. Pressure is released immediately, and thence, during the remainder of the stroke, the piston is simply pulled down by the crankshaft. This portion

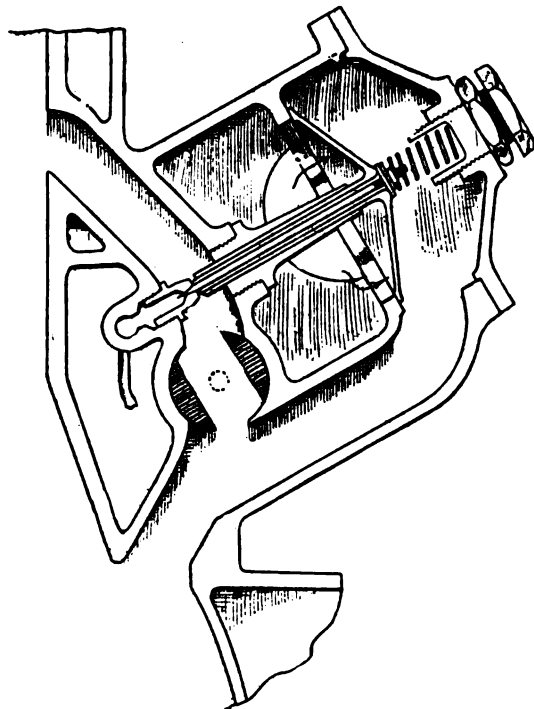

Section of Carburetor Showing Gasoline Feed, Air Intake Disc and Needle Valve.

of the stroke is absolutely negative. But it is unavoidable in the orthodox design, because space must be provided for the accommodation of the exhaust and inlet ports as well as for some clearance. And the ports must be of generous area, otherwise there may be a throttling of the exhaust gases or wire-drawing of the inlet; therefore, the space required will be, relatively to

the stroke, of considerable magnitude. Hence it is that the distance, A.B., representing the effective stroke, is but little more than half the full or actual stroke, A.C. In some cases, as stated, it may be no more than half. A clumsy designer can, indeed, lose a great deal in this way.

What makes matters so much worse for the efficiency of the engine is that pressure ceases behind the piston just about that point where it may be most effective in turning crankshaft. With any other type no engineer would think of lifting exhaust valve

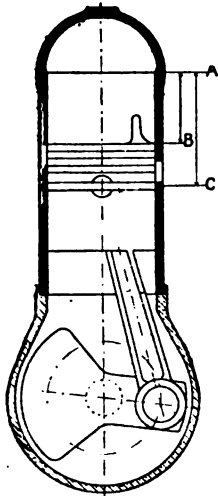

Fig. 1.

with crank at angle indicated in Fig. 1. In the average two-stroke motor it must take place at about such angle. The inlet aperture commences to uncover as soon as exhaust port is opened by descent of piston. This gives ingress to charge, which has been slightly compressed in crank chamber.

It is urged that the forcible injection of each charge into the cylinder serves to drive out the residual burnt gases. Possibly it does so in a small measure, but that must mean a corresponding loss of such charge in following the exhaust products into the silencer. In spite of the baffle on the piston-head to deflect the entry of the fresh gases, expansion is bound to occur. The

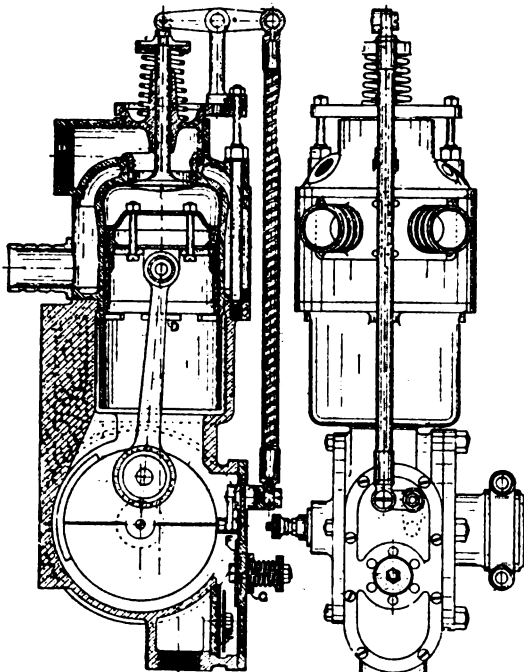

Fig. 2.

Fig. 3.

so-called "sweeping out" is, therefore, much more likely to be a "flooding out" by a more-or-less intimate mixture of burnt and unburnt gases, and a certain portion thereof must inevitably be lost before the exhaust port can be closed again by the return-

ing piston. And since the piston is moving slowly during this early portion of its stroke, every opportunity is offered for an escape of useful fuel.

It is evident that, if the efficiency and "flexibility" of a two-stroke motor are to be improved, the actual piston stroke must more approximately represent positive action and work done than it does in most existing engines of this type, and means must be had to close the cylinder directly after the fresh charge has entered—or before it found desirable. There must be no open exhaust port to give free exit for the combustible mixture ere it can be compressed preparatory to ignition. It becomes advisable to let the exhaust port be at head of cylinder and inlet at bottom. In Fig. 2 is given a sectional view of a proposed motor.

The inlet ports (D) surround cylinder, as does the annex of the crank chamber which forms, with the lower part of the cylinder, an annular lead to the parts. To get good compression the crank chamber is only just large enough to contain crank disc, and allow for clearance of connecting rod. Since inlet ports have maximum length circumferentially, they may be very short in the axial line of the cylinder, without sacrificing area. This is the first step towards the saving of space succeeding the effective stroke of the piston. The exhaust is effected, not through a port in the side of the cylinder, but by a valve in the head. This valve can be overhead or in a pocket, as preferred. It is operated by a "trip" on the periphery of the crank disc. Gearing is not required, of course, inasmuch as the valve has to be opened at each revolution of the crankshaft.

The valve is timed to open at a point which, by experiment, gives the best results. Generally, it will be correct to open the valve when the lower edge of the piston-head is within a distance from the top of the inlet ports equal to one and two-thirds of their depth. In the motor shown, this distance is 5-16 in., the depth of the ports being 3-16 in. The total required for exhaust and inlet openings is, hence, only 1/2 inch—probably less than would be devoted to one port in the usual design.

In this case there will be a better scavenging effect than is obtained where both ports are located in lower portion of cylinder.

The crank chamber is shown fitted with three valves. The first (E) is the inlet in connection with the carburetor. It is of automatic disc type and very sensitive. A spring is not wanted. The seating is merely a perforated disc of bronze.

The valves on the cover of the crank chamber are of a somewhat similar type, but are provided with a spring, which is common to both. That on the outside of the cover is intended to afford some relief should a backfire occur. The passage to this valve is through holes in the lower valve (F), which register with an annular groove in the seating valve (F), whence holes lead to the seat of the outside valve (G). The inner valve serves to admit air to the engine when the throttle is closed.

It will be clear that the cylinder casting is an exceedingly simple affair, and that, if desired, it can readily be machined all over. This, by the way, should be distinctly advantageous in an air-cooled motor for cycle or aeroplane work. And, so far as the former is concerned, the exhaust valve, together with a "lifter," would be another useful point.

WHAT THE SWISS ARE DOING.

The Zurich Corporation, which governs the famous Swiss community, has decided to grant no further licenses to gasoline cabs, holding that electric cabs can be operated as efficiently and economically without the noise and odor of the gasoline vehicles.

CARRIAGE WORKERS OPEN LABOR BUREAU.

The Carriage and Wagon Workers' Union, New York City, has established its employment agency in Labor Lyceum, Wiloughby and Myrtle avenues. The office will be open daily from 8 to 9 o'clock A. M.

QUEER USES FOR SECOND-HAND AUTOMOBILES.

The introduction of the modern automobile for commercial purposes has resulted in the application of gas to many of the machines. In recent years a great many second hand motor vehicles have been purchased with a view of re-constructing them for mercantile purposes. The buyers search the junk dealers and other places where complete automobiles or parts of automobiles may be found in an abandoned condition. Some

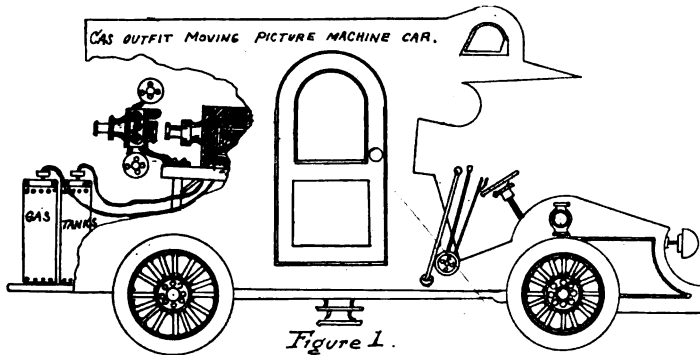

of these machines thus obtained are secured at remarkably low prices. The old and wrecked machines are given thorough overhauling. Platforms are arranged for the carrying of gas tanks or supplies. The object is to furnish travelling merchants with some sort of an outfit with which they can transport their goods. The steam power auto is not very popular. The electrical machines are not used very much for this special service. The gas and gasoline machines are preferred. Hence we meet with men who make a business of collecting old machines in order that they may rebuild them for the purposes in question. This has caused some of the gas men to undertake the remodelling of machines. Some of the makers of hydrogen and oxygen gases for moving picture service have done quite a business in this line.

The moving picture machine business has assumed large proportions in nearly all portions of the country. Some of the moving picture machine men have had the dealers in second hand automobiles fix up cars according to the plan shown in Fig. 1. Then the machine is run into a city or town where the advertisers are enterprising. The owners of the picture outfit exhibit attractive moving pictures on a sheet or on a white wall

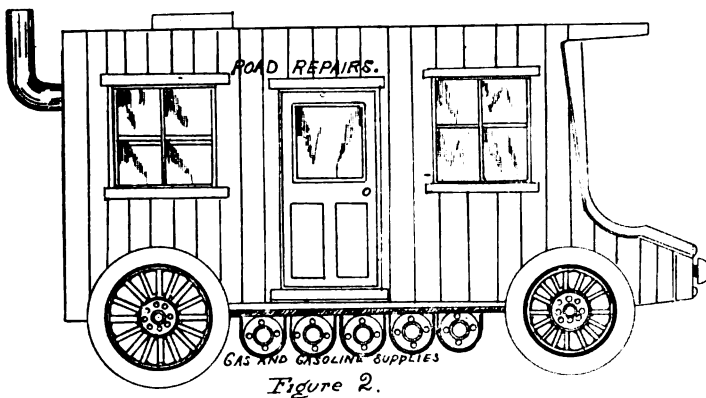

in the public square or some other prominent place. Between every run of a film they exhibit the name of some advertising firm, at a certain fee per night, per week or per month.

Often the moving picture advertising man has about all he can handle in this line. He makes money. He has his supply of gas in the two tanks shown on the brace at the rear of the car. He can get his tanks refilled at calcium light supply houses along the route. Or he can use a gasoline light, making vapor from his supply for the mechanism of the automobile. This gasoline is vaporized by heat and the vaporized material mixes with the air at the burners and forms an intense white light on

a mantel. Others carry a carbide gas making outfit, utilizing the acetylene gas in a series of burners in the picture machine. The hydrogen and oxygen gases can be united and burned together on a lime until the lime is an intense white heat. The light is powerful enough for moving pictures. Or, oxone is bought and the gases released by using the stuff in a tank of water. Then the hydrogen is obtained from a saturator with ether or gasoline.

Then the second hand or abandoned automobiles are often rebuilt according to the style shown in Fig. 2. Here we observe a machine on which something like a house has been erected. I saw one of these moving houses not long since, in which the man who owned it lived and worked. He built up the sides and ends of the affair with common pine boards. He put on a roofing and constructed a floor. He acquired a perfect apartment in which he placed all the necessary emergency devices for doing work on automobiles. He carried considerable gasoline in tanks attached below the frame. Hence when a machine along the speedway needed oil, he could furnish it. He carried tires, nuts, bolts, wires, screws, and fixings of all kinds. He had his little boring device and likewise a small lathe for turning purposes. He carried cement and utensils for repairing leaking tubes. He had an extra tire and a wheel. Lubricating oil and in fact everything an automobilist would be likely to require, this man carried in his home-made structure. This structure could be run slowly about the places where automobiles

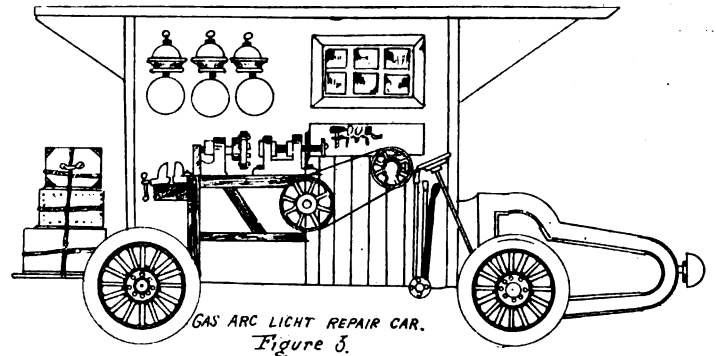

were in use. The man always secured plenty of business. He was making money at the time the writer met him.

Another line of work in this direction appertains to the fixing and supplying of gas arcs for stores, hotels, restaurants, offices, dwelling houses, apartment houses, barber shops and exterior service. Many gas arcs are used by the commercial people for exterior display service. Therefore a number of professional gas arc repair and construction men have been earning a good income by running gas arc repair cars.

One of these cars is shown in Fig. 3. This car was re-constructed from an old automobile. The interior was entirely removed and in place of the seats and other accommodations, a plain board floor was put down. On this the work bench and various convenient machines and tools were placed in the order shown in the cut. A number of extra gas arc lamps are carried. All the necessary parts of the lamps and attachments are kept in special apartments on the car for immediate service. There is a cleaning equipment. In fact, contracts are made with the users of the gas arc lights to keep the lamps in good running order at so much per month. This involves the restoring of any broken parts. A high wind may tear down the system of advertising gas arcs. The repair company immediately proceeds to put things into shape. The owner of the equipment is nothing out. The monthly stipend covers everything. Many of the users of gas arcs estimate that it is better to place the care of their lamps in the hands of professionals at so much per month than to undertake the care of the outfit themselves.

When a person uses strong protestations, or oaths, to confirm what he says, depend on it, he lies; and is only interested in deceiving you.

AEROPLANE MOTORS.

The Motor Needed for Flying Must Add Steady Going to Other Qualities—Which of These Types Will Win?

Considerable interest is expressed by the designers of flying machines in the offer of Edwin Gould of a prize of \$15,000, which, as he says in his formal offer made through the Scientific American, "is to be given to the inventor who designs and demonstrates in this country the best heavier-than-air flying machine equipped with more than one propeller, and with more than one independent motor, in such manner that the motors can be operated together or independently."

"My object in offering the prize," says Mr. Gould, "is to encourage the invention of a heavier-than-air flying machine which will be able to continue in safety on its course, even though one of the driving devices should break down. In order that the efficiency of the invention may be thoroughly tested it will be necessary to subject them to endurance tests of stipulated length of time or distance."

An approved engine is the most urgent need of aviation to-day. The developments made in flying in the past six or eight months have put it up to the engine to keep pace. An aeroplane of good make can stay in the air in good weather now until the gasoline gives out, unless the engine gives out first. And this the engine is very likely to do.

Aeroplane progress has, therefore, completed a while cycle, and is back where it started, though with immense advances to its credit. Until there came an engine sufficiently light for its power to lift engine, fuel, passenger and supporting planes no human flight was possible. Then, in the '90s, they began to perfect the gasoline internal combustion engine, the type of en-

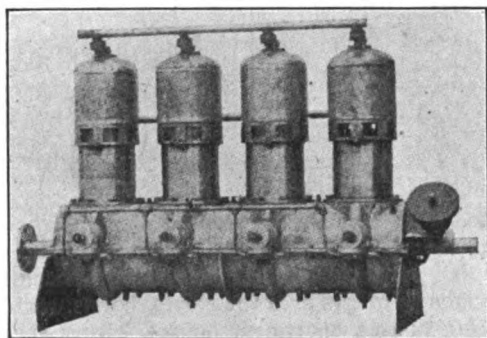

Whitehead Motor.

gine where the piston is driven by the explosion of gas in the cylinder itself. The first result of the highest form of motor for its weight yet known was the automobile. The development of the automobile helped along the process of lightening the type of engine.

Some flying had been done with steam engines, it is true, prior to the development of the gasoline engine. A large aeroplane built by Sir Hiram Maxim in 1893 and running on restraining rails to hold it to the ground rose so powerfully as to break the restraining rails. Clement Ader, on October 14, 1897, made the first actual human flight, going 984 feet through the air on a machine of his own design. But flight with steam motors was too difficult and these feats remain without further result.

In the early part of the decade just passed there came the perfected automobile engine. Very soon after, in 1904 and 1905, the Wrights were flying with the new type of engine, and in their secret experiments were making up to twenty-four miles in length. Their machine combined the advantages of a light engine and the principles of wing-warping, then just coming into use in an elementary form on gliders for descending from balloons. But the engine was the element that made flying easy.

As soon as the world knew that the Wrights were able to fly there developed an enormous interest in aeroplanes. Some emulators copied the Wright design more or less closely, while

others tried various widely differing types. The manufacturers of various brands of advanced type of gasoline engines put out aeroplane designs and made flights less for direct profit than to build up a future market for their engines. It was found that while a great number of the various aeroplane designs would not fly a pretty fair number of them of very different shapes and principles would fly and were fairly reliable in calm weather.

When this was discovered the systematic competitions for

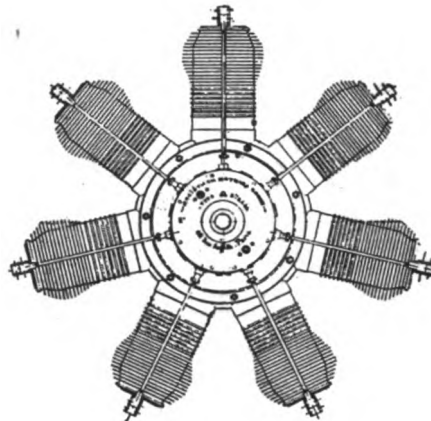

Gnome Motor.

speed and distance flights were established. But at first no one cared to fly across country. This was because all the engines and aeroplanes were too chancy to warrant flyers risking their necks over rocks, houses and trees, or going to any great height.

In the summer of 1909 the aviators felt such confidence in their machines that they started the long series of cross-country flights, which have gone on ever since. These flights marked the development of a flying machine that could be relied upon to stand up in ordinarily calm weather, could carry a large supply of gasoline and could land and start safely. They did not mark the development of a reliable engine.

The successful cross-country flyers managed to keep their engines going uninterruptedly for long periods, but it was always a matter of uncertainty how long the engine would keep going before it stopped and let the aviator down, willy-nilly. Only now that aeroplane controls turned out to be reliable, it was an easy matter for the aviator to protect himself against awkward drops. All that he had to do was to rise to a height of a thousand feet or so. Then, when the power gave out, he could glide down to any spot that he picked out, within a mile or so of radius.

This system, with a little boldness on the aviator's part, did very well. A man intending to take a cross-country prize would tune his machine up and try it out until the motor gave every sign of being in condition to work well for a few hours. He

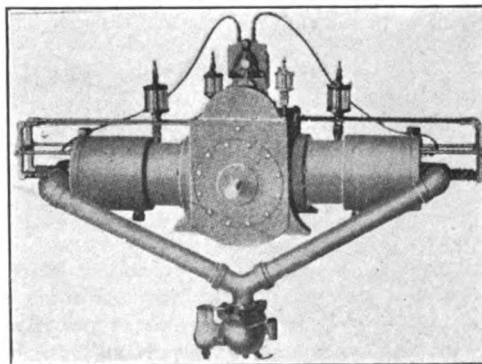

The Call Aviation Engine.

would then start out, and if all went well with the motor he would win the prize. In this way Paulhan made the London-Manchester flight, Curtis came down the Hudson River and Bleriot crossed the English Channel. In each case it was just a question of the motor holding out.

But now the success in holding the first cross-country flights and the prizes offered are breeding competition. It is no longer a question of a large money prize remaining untried for until some one comes along and flies over the required route. There are now several large cross-country prizes up, in this country alone. Each one of them is likely to have several competitors.

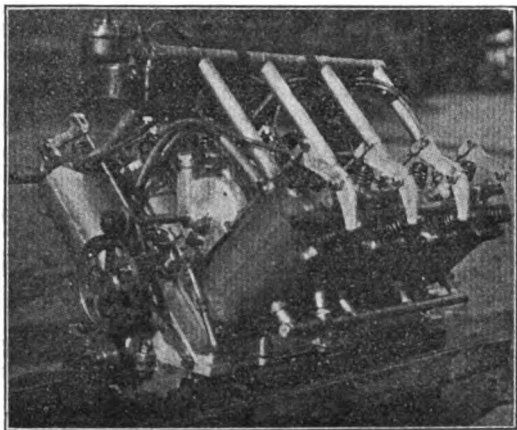

Curtiss Engine.

It is this new state of things that brings the present improvement of aviation right back to the original question of the motor. Progress has gone right around the circle, till now the motor counts for everything. In the flights of the next few months it is the best motor that will win.

Much of the problem of the motor has been solved. The motor is now plenty light enough for the horsepower needed, for one thing. Fully half a dozen motors are built that develop one horsepower to each two to four pounds of their weight. Light water cooling, and air cooling devices, both have been perfected. Only the length of time for which the best engines will run is still a problematical matter. Right there comes in the crucial point on which the future flights are likely to be decided. It is no longer the motor that may, but the one that will surely stand up for a long run, which will win.

Reliability is the quality which all the aeroplane motor builders are seeking to-day. They are even ready to give up something in power, for the sake of it. How to gain reliability is a problem of which it is hard to predict the manner in which it will be accomplished through a more careful and solid building

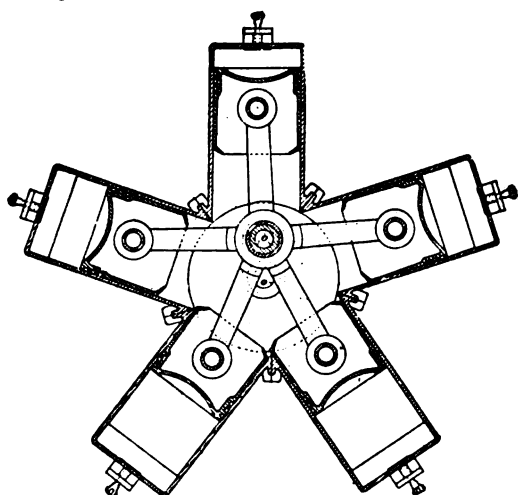

Sectional View of Adams-Farwell Motor.

of the parts than through any new design of engine. There are already a great variety of engines used on aeroplanes. Probably some particular form will survive among all these and the reason for its survival will be that it can be improved above the others in respect to reliability.

The most advanced motors made for aeroplanes to-day vary greatly. This dissimilarity prevails in respect to the number of

cylinders, the arrangement of the cylinders around the shaft, the nature of the fuel injection, the devices for cooling the cylinders, the lubricating arrangements, and other important points. It is not yet settled whether the air-cooled or the water-cooled type of motor will finally be the favorite. The majority of motors now use the carburetor, but at least one very successful motor, the Antoinette, feeds the fuel to the cylinders by a direct injection device.

The most interesting point of difference among the engines, however, is as to the arrangement of cylinders. Some three or four years ago a foreign manufacturer conceived the idea of placing the cylinders slantwise along the shaft on two opposite slants, V-shape, to reduce weight. This scheme enabled him to shorten the shaft and case by edging in more cylinders to a given length of shaft. It is in the way of developments to this idea that the modern engines, the best of to-day, have sprung up.

They show three sorts of arrangements of cylinders. One arrangement is that of opposed cylinders. The cylinders lie horizontally to the right and left of the horizontal shaft. In the V-shaped arrangement, the cylinders, instead of being horizontal, point partly downward toward the shaft, like the upper spokes of a wheel. Sometimes they are in two opposed rows, all at the same oblique angle; sometimes they run from the vertical position nearly down to horizontal. The third arrangement, that of radial cylinder, is the most complicated of all. The cylinders

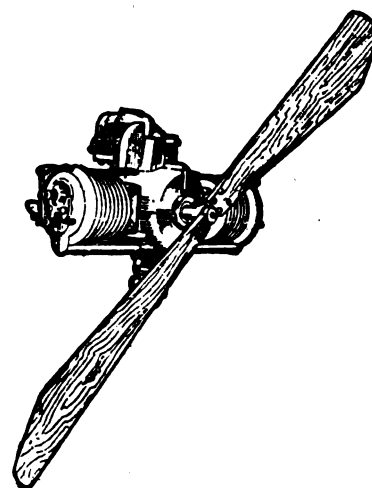

The Detroit Aero.

are arranged spokewise, clear around the shaft. As cylinders pointing downward from the shaft do not work well, this type cannot be set in the usual way. Either the cylinders are laid flat and the shaft vertical, or else the cylinders are made to revolve, with the propeller, around a stationary shaft.

In point of number and power of cylinders the various motors vary as much as in any other respect. The number of cylinders used runs all the way from two up to a dozen or more. The more cylinders are used the more perfectly the forces counterbalance and the more smoothly the motor runs, but the more numerous the cylinders the greater is the chance that a single cylinder, getting out of order, will upset the whole combination and paralyze the motor. Strange to say both the very low number of cylinders and the very high have given good results in actual flight.

Several makes of motor which have shown promise may be mentioned. The Wrights have done most of their best flying with a four-cylinder motor, upright cylinders of the old type, in which lightness is sacrificed to serviceability, as throughout the Wright machine. Water cooling is employed. The present Curtiss motor, on the other hand, is a modern type motor, developing 1 horsepower to somewhat over 3 pounds weight. Its eight cylinders are arranged in two rows like four V's, one behind the other, standing on the shaft box. Curtiss recently gave

up air-cooled motors to try water cooling as more reliable, though heavier.

Of the French motors, none is more remarkable than the Darraq motor, used on Santos-Dumont's Demoiselle monoplane. It weighs but sixty-six pounds and develops thirty-five horse power. It has two opposite cylinders and a water cooling system. Santos-Dumont uses it on the smallest aeroplane in use, the little monoplane that captured the speed record for one kilometre, though it has but eighteen feet of wing spread.

The Gnome is the most ingenious and one of the most successful of the air-cooled motors. The cylinders, seven in number, are arranged like spokes around a hub and revolve with the propeller. By means of this revolving motion they are forced through the air at a rate of about 90 miles an hour. The cylinders are corrugated with projecting rings on the outside, which helps radiate their heat. The whole affair develops about 50 horsepower with a weight of about 175 pounds, somewhat over three pounds to the horsepower. The whole motor is ground down from a single casing, to avoid joints and vibration. With a Gnome motor Bleriot has made some of his remarkable flights. Another motor used by Bleriot is a three-cylinder Anzani. The cylinders are arranged one vertically on top and one slantwise on either side.

The Antoinette motor, for the demonstration of which the Antoinette plane has been steadily developed, is a 50-horsepower V-shaped, air-cooled motor of eight cylinders, four on each side. It is light, though not among the lightest. The R E P motor, built by Robert Esnault-Pelleterie, a French engineer, and used on his R E P monoplane, is another successful air-cooled motor. It has ten cylinders, arranged like the spokes on the upper half of a wheel only.

Which of these various types of motor will finally be the one to issue into perfection and general use is hard to tell. Thus far the best results have been obtained by the water-cooled motors, especially those not over eight cylinders.

BLACKSMITHS OPEN WAR ON CLEAR STREETS LAW.

The initial move of the Newark (N. J.) Wagon Builders' Association, recently organized by the blacksmiths to fight a mandate of the street department prohibiting the leaving of wagons undergoing repairs in front of shops, was made July 29 before Judge Herr in the Fourth Precinct Police Court.

Ten members of the association were charged by Inspector Gottlieb Hanle, of the street department, with having violated the ordinance respecting obstructions in the streets, but only one case was tried. When a fine of \$10 and costs was imposed James R. McDermitt, counsel for the association, announced his intention of appealing. The court then set down the other cases for August 9.

The first case was that of Abraham Rasnik, of 138 Broome street. George F. Carpenter, an assistant to the city counsel, conducted the case on behalf of the city, the chief witness being Mr. Hanle. The latter told the court that the man had been warned many times, and had been allowed to go on one occasion with a severe reprimand. Mr. Hanle also stated that the streets in some cases were so blocked that fire engines would find it a serious task to make passage.

Mr. Rasnik said that in his case the wagons had been left in front of his shop by patrons, and were there only for a matter of two or three hours.

"If it was a big job, I'd have to take it in the shop," he explained.

The court immediately after counsel had summed up, found the defendant guilty and imposed the fine. Then Mr. McDermitt declared his intention of appealing. This caused the court to postpone the other cases, it being the intention to allow the disposition of the appeal to govern all.

Observe not only what is said, but how it is said.

THE G. & J. TIRE CO.

The interests of the G. & J. Tire Co. and the Indianapolis Rubber Co. have been merged and articles of incorporation have been granted under the laws of Indiana for the formation of a new company, to be known as the G. & J. Tire Co. of Indiana. There will be no liquidation of the original G. & J. Tire Co. and the Indianapolis Rubber Co. The G. & J. Tire Co. of Indiana assumes all liabilities of the Indianapolis Rubber Co. The G. & J. Tire Co.—of New Jersey—as a patent holding corporation, will continue to exist. The management of the G. & J. Tire Co. is in the hands of Mr. Byron C. Dowse, as president, and Mr. Richard Ward, as secretary and treasurer.

RELIABILITY RUN FOR MOTOR TRUCKS.

A motor truck reliability run, to be held August 12-13, under the auspices of the Philadelphia North American, is the first event of its kind ever attempted. The route from Philadelphia to Atlantic City will be long, varied and populous enough to test the commercial vehicles under the eyes of a considerable section of the public. The Quaker City Motor Club will co-operate with the newspaper.

Wants

Help and situation wanted advertisements, one cent a word; all other advertisements in this department, 5 cents a word. Initials and figures count as words. Minimum price, 30 cents for each advertisement.

HELP WANTED.

Foreman Body Builder Wanted—A large manufacturing company in the Middle States has engaged in the manufacture of automobile bodies. Their work consists of coupe and victoria bodies for electric vehicles and all types of high grade panel top business wagon bodies. With a splendid machine equipment all work is delivered to the bench men completely machined and ready for assembling. They desire to secure the services of a capable man to take charge of the bench work department, a man thoroughly versed in heavy coach body work, an organizer capable of producing high class work at a minimum expense. They desire to correspond with any one capable of filling such a position. The best of references will be required. Address, Body Builder, care The Hub, 24 Murray street, New York, N. Y.

Wanted—A thoroughly experienced foreman painter for high class buggy work. Age thirty to forty years preferred. A man of good business and executive ability, to work men and material profitably, desired. Good references required. Address, E. S. H., care The Hub, 24 Murray street, New York, N. Y.

POSITION WANTED.

Wanted—Position to take charge of a shop by a coach and automobile painter at present employed. Long experienced in handling men and always on first class work. Nothing but the very best will be considered. Communications confidential. References. Address Box 89, The Hub, 24 Murray street, New York.

FOR SALE.

For Sale—Carriage and auto painting business in city of 30,000 population. Well arranged and best location, doing business of \$4,000 per year, or average. Reason for selling, ill health. Will dispose of at a sacrifice. Address J. J. 41, care The Hub, 24 Murray street, New York.

For Sale—Factory Building and property, finest factory site in state of Iowa on the Mississippi River. In heart of city of 25,000. Shipping facilities first class. Tracks right on property. Will sell cheap to satisfy two family estates. Address X, care The Hub, 24 Murray St., New York.

For Sale—A well established buggy and wagon business. Box 192, Gainesville, Fla.

For Sale—An old established wagon and truck manufactory, located in Greater New York. Handling good line of new and repair work. Address Box 444, The Hub, No. 24 Murray street, New York.

PATENTS.

Patents—H. W. T. Jenner, patent attorney and mechanical expert, 608 F St., Washington, D. C. Established 1883. I make a free examination and report if a patent can be had and exactly what it will cost. Send for circular.

Timken Roller Bearings

not only reduce friction to a minimum, but enables two horses to do the work of four in actual hauling.

They can be fitted to all classes and styles of carriages and wagons, adding a selling value to them. And this live dealers know.

TIMKEN ROLLER BEARINGS

require little or no adjustment—are easily gotten at—are simple and fool-proof, requiring oiling but once a month and are sold under a two years' guarantee.

These are a few of the reasons why

TIMKEN ROLLER BEARINGS

are being used by Ninety odd (90) per cent of all the makers of high grade American Automobiles in part or throughout their cars.

If you are not using them, write us for REASONS why you should.

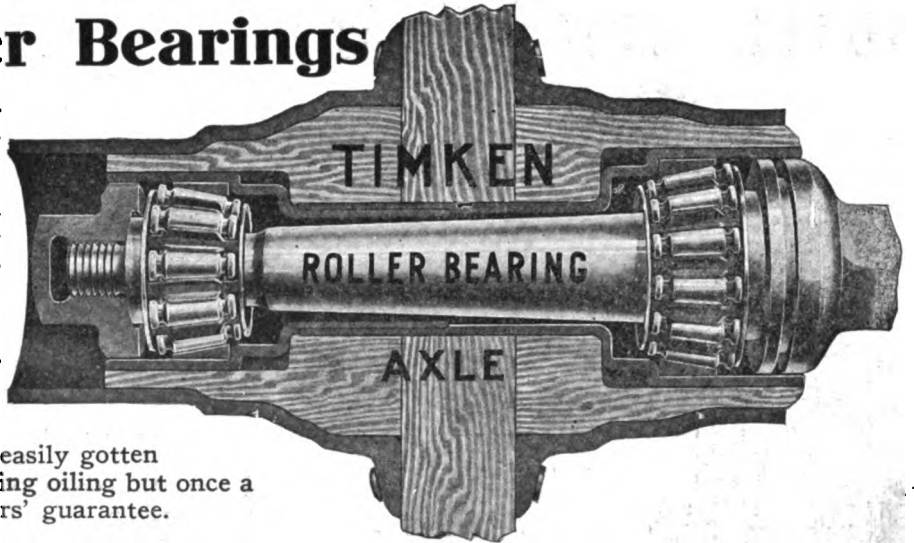

Branches
10 E. 31st Street, New York
429 Wabash Ave., Chicago, Ill.

THE TIMKEN ROLLER BEARING CO. Canton, Ohio.

Cover a carriage top with MERITAS enameled oil cloth—cover another with any other kind—follow them up and see how long the tops last.

MERITAS will be in good condition long after the other has been caked, cracked and weather-killed.

Try it—then stick to the kind that lasts the longest.

Look on the back of the goods for our trademark.

See Your Jobber.

Standard Oil Cloth Co.
320 Broadway, New York

A \$100 Typewriter for 17 Cents a day!

Please read the headline over again. Then its tremendous significance will dawn upon you.

An Oliver Typewriter—the standard visible writer—the \$100 machine—the most highly perfected typewriter on the market—yours for 17 cents a day.

The typewriter whose conquest of the commercial world is a matter of business history—yours for 17 cents a day.

The typewriter that is equipped with scores of such conveniences as "The Balance Shift"—"The Ruling Device"—"The Double Release"—"The Locomotive Base"—"The Automatic Spacer"—"The Automatic Tabulator"—"The Disappearing Indicator"—"The Adjustable Paper Fingers"—"The Scientific Condensed Keyboard"—all

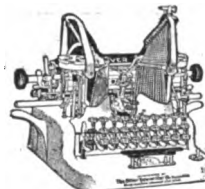

Yours for 17 Cents a Day!

We announced this new sales plan recently, just to feel the pulse of the people. Simply a small cash payment—then 17 cents a day. That is the plan in a nutshell.

The result has been such a deluge of applications for machines that we are simply astounded. Demands come from people of all classes, all ages, all occupations. The majority of inquiries has come from people of known financial standing who were attracted by the novelty of the proposition. An impressive demonstration of the immense popularity of the Oliver Typewriter. A startling confirmation of our belief that the Era of Universal Typewriting is at hand.

A Quarter of a Million
People are Making
Money With

The OLIVER Typewriter

THE STANDARD VISIBLE TYPEWRITER

The Oliver Typewriter is a money-maker, right from the word "go." So easy to run that beginners soon get in the "expert" class. Earn as you learn. Let the machine pay the 17 cents a day—and all above that is yours.

Wherever you are, there's work to be done and money to be made by using the Oliver. The business world is calling for Oliver operators. There are not enough to supply the demand. Their salaries are considerably above those of many classes of workers.

Write for further details of our easy offer and a free copy of the new Oliver catalog. Address

The Oliver Typewriter Company

310 BROADWAY NEW YORK CITY

Please mention "The Hub" when you write.

HOTEL CUMBERLAND

NEW YORK

Southwest Cor. Broadway at Fifty-fourth St

Near 50th St. Subway Station, 53d St. Elevated and all Surface Lines.



Headquarters for
Carriage and
Automobile Trade

Ideal Location, Near Theatres,
Shops and Central Park.

NEW AND FIREPROOF
STRICTLY FIRST-CLASS

RATES REASONABLE
All Hardwood Floors and
Oriental Rugs.

Ten Minutes Walk to
Twenty Theatres.

Transient Rates, \$2.50 with Bath, and up.

Excellent Restaurant. Prices Moderate.

SEND FOR BOOKLET.

HARRY P. STIMSON, R. J. BINGHAM,
Formerly with Hotel Imperial. Formerly with Hotel Woodward.

INDEX TO ADVERTISEMENTS.

| | |
|------------------------------------------------|-----------|
| American Ball Bearing Co., The | 2nd Cover |
| American Roller Bearing Fifth Wheel Co. | 10 |
| Bradley & Son, C. C. | 4th cover |
| Cargill Company | 4 |
| Columbus Bolt Works | 4th cover |
| Consolidated Rubber Tire Co | 6 |
| Crane & MacMahon | 2d cover |
| Devoe, F. W., & Reynolds Co., C. T. | 3d cover |
| Eberly & Orris Mfg. Co. | 3d cover |
| Eccles Co., Richard | 10 |
| English & Mersick Co., The | 2 |
| Gifford & Son, John A. | 11 |
| Goodrich Co., B. F., The | 5 |
| Hoopes Bro. & Darlington, Inc. | 2d cover |
| Jones & Co., Phineas | 1 |
| Keystone Forging Co. | 1 |
| Kimble Andrew | 3 |
| LeCompte Mfg. Co. | 13 |
| Lounsbury & Sons, G. H. | 3d cover |
| Masury & Son, John W. | 2 |
| McKinnon Dash Co. | 4th cover |
| Moller & Schuman Co. | 3 |
| Mott Wheel Works | 3rd cover |
| Murphy Varnish Co. | |
| National Spring and Wire Co. | 1 |
| Porter, H. K. | 10 |
| Russell, Burdsall & Ward Bolt and Nut Co. | 3d cover |
| Schubert Bros. Gear Co. | 11 |
| Smith & Co., Edw. | 3 |
| Spring Perch Co. | 1 |
| Standard Oil Cloth Co. | 9 |
| Standard Wheel Co. | 1 |
| Timken Roller Bearing Co. | 9 |
| Uebelmesser Co., Charles R. | 12 |
| Valentine & Company | 3 |
| West Tire Setter Co. | 11 |
| Wilcox Mfg. Co., D. | 11 |
| Wiley Co., C. A. | 2 |
| Woodman, Joel H. | 12 |



Richard Eccles Co., Auburn N. Y.

Manufacturers of

Forgings: Carriage, Wagon, Automobile, Special

Send for Catalogue.

TRUCK BUILDERS

If you only realized the inestimable value of roller bearing fifth wheels on trucks, vans, delivery wagons and all other medium and heavy vehicles, no job would leave your shop without

Roller Bearing Fifth Wheels

WHY? The adjustment is perfect. No oil or grease required. Almost indestructible. Will outwear any vehicle. Saves horseflesh and prolongs life of vehicle. Ask your jobber for the celebrated

NIELSON OR KING

Let us send you Catalogue and Price List.

American Roller Bearing Fifth Wheel Co.

745 THIRD AVE., BROOKLYN, N. Y.

Please mention "The Hub" when you write.

FIFTH WHEELS—FORGINGS

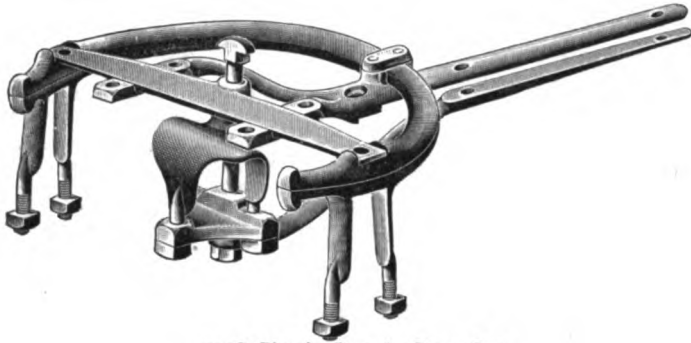

1908 Single-Reach Gear Set.

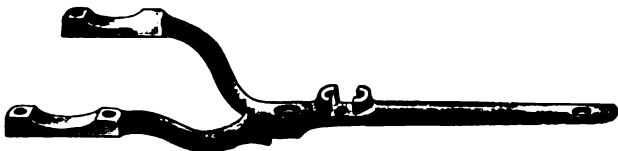

Detachable Fork Perch Connection Used in 1908 Gear Set.

Greatest Line on Earth

WHEN ORDERING GEAR SETS BE SURE TO GET THE GENUINE

Wilcox Rear King-Bolt Gear Sets

WRITE US FOR FULL PARTICULARS

THE D. WILCOX MANUFACTURING CO.

MECHANICSBURG, PENNSYLVANIA

ESTABLISHED 1886.

Correspondence School of Carriage and Motor Carriage Drafting

A thorough, practical tuition is given through this correspondence school. The theory and practice of construction, bookkeeping, perspective. Many men now hold good positions through taking the courses of instruction.

Principal, THOS. MATTISON,
Hillside Avenue, Bitterne Park,
Southampton, England.

Author of "The Coach Body Makers' Guide," \$3.00; a practical treatise on "The Suspension of Carriages," "Bookkeeping," and other carriage building works.



VEHICLES AND GEARS IN THE WHITE



PREMIER SIDE SPRING GEAR

We manufacture a full line of Carriage and Wagon bodies in the white; also Limousine, Taxicab, Touring Car and Roadster Bodies for automobiles in metal. Fifty styles of gears for Carriages and Wagons; also seats, trimmings and tops of all kinds.

Write to us for particulars.

Schubert Bros. Gear Company

ONEIDA, NEW YORK.

The WEST Hydraulic Tire Setter WILL CUT DOWN EXPENSE



Tires set cold in one minute. This machine saves time — does the work better and quicker, does away with burned streaks. Only necessary to measure one wheel in a lot. Does not char the rim and

thus make the tire loosen prematurely. Saves re-sandpapering of wheels.

This machine is now increasing the profits of many manufacturers. Send for catalog and read about it.

WEST TIRE SETTER CO., ROCHESTER, NEW YORK

Please mention "The Hub" when you write.



Painters and Decorators Save Time, Labor and Money, using the

Uebelmesser Striping and Stencil Wheel

With this simple, clean and rapid-action tool the most ordinary decorator can do the finest striping and stencil work and produce a bigger day's work with less labor than by the old fashioned method. Complete directions are furnished with each tool. They are as simple as the tool itself.

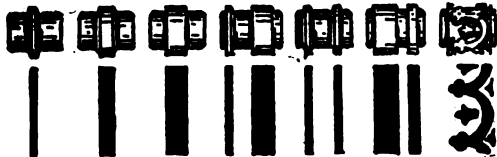

Just a few of the many designs that can be produced with the Uebelmesser Painters' and Decorators' Tool. (The designs shown above are reduced in size)

Complete Outfit consisting of Machine, 10 Plain and 10 Ornamental Wheels, only . . . **\$5.50**

LIBERAL DISCOUNT TO THE TRADE

Manufactured by

Charles R. Uebelmesser Company
Bayside, New York, N. Y.

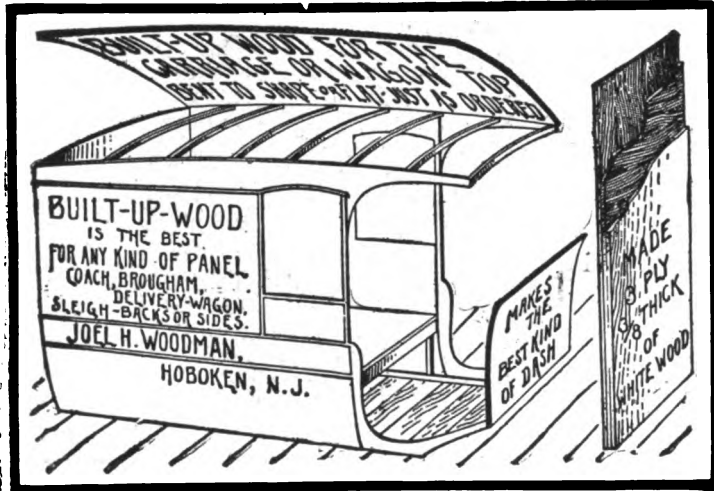

Journal for the Carriage and Automobile Trade

The Hub

Published Monthly at Two Dollars per Year

Advertisements Classified

The following list includes advertisers in THE HUB. Each advertiser is entitled to name under one heading only. An extra charge for name under more than one heading.

Automobile Parts.

LeCompte Mfg. Co., New York City.

Axles, Etc.

American Ball Bearing Co., Cleveland, Ohio.

Timken Roller Bearing Co., Canton, Ohio.

Bodies, Seats, Etc.

Woodman, Joel H., Hoboken, New Jersey.

Bolts and Nuts.

Columbus Bolt Works, Columbus, Ohio.

Russell, Burdshall & Ward Bolt and Nut Co., Port Chester, N. Y.

Carriage Cloths.

Wiese & Co., Wm., New York City.

Carriage Forgings.

Columbus Bolt Works, Columbus, Ohio.

Eccles Co., Richard, Auburn, N. Y.

Keystone Forging Co., Northumberland, Pa.

Carriage Hardware.

Gifford & Son, John A., New York.

Carriage Goods.

English & Mersick Co., New Haven, Conn.

Gifford & Son, John A., New York.

Herbrand Co., The, Fremont, O.

Dashes, Fenders, Rails, Etc.

McKinnon Dash Co., Buffalo, N. Y.

Fifth Wheels.

American Roller Bearing Fifth Wheel Co., Brooklyn, N. Y.

Wilcox Mfg. Co., D., Mechanicsburg, Pa.

Gear Woods.

Andrew Kimble, Zanesville, O.

Jacks.

Hankinson, J. V., Franklin, O.

Lamps.

Gifford & Son, John A., New York.

Stevens & Sackett Co., New Haven, Conn.

Machinery and Tools.

Barnes Co., W. F. & John, Rockford, Ill.

Porter, H. K., Everett, Mass.

West Tire Setter Co., Rochester, N. Y.

Miscellaneous.

Standard Oil Cloth Co., New York.

Uebelmesser Co., Charles R. Bayside, New York, N. Y.

Rubber Tires.

Consolidated Rubber Tire Co., New York City.

Goodrich Co., B. F., Akron, O.

Goodyear Tire and Rubber Co., Akron, O.

Swinehart Climber Tire & Rubber Co., Akron, O.

Shaft Couplings and Anti-Rattlers.

Bradley & Son, C. C., Syracuse, N. Y.

Eccles Co., Richard, Auburn, N. Y.

Metal Stamping Co., New York City.

Springs and Gears.

Akron-Selle Gear Co., Akron, Ohio.

Mulholland Co., Dunkirk, N. Y.

National Spring and Wire Co., Albion, Mich.

Spring Perch Co., Bridgeport, Conn.

Trimming Materials.

Stevens & Sackett Co., New Haven, Conn.

Varnishes, Paints and Japans.

Devoe, F. W., and C. T. Raynolds Co., New York City.

Harland & Son, Wm., London and New York.

Masury & Son, John W., New York and Chicago.

Moller & Schumann, Brooklyn, N. Y.

Moore & Co., Benj., Cleveland, Ohio.

Murphy Varnish Co., Newark, N. J.

Pierce Co., F. O., New York.

Smith & Co., Edw., New York.

Valentine & Co., New York, Chicago, Boston, Paris.

Wiley Co., C. A., Hunter's Point, New York City.

Wheels.

Crane & MacMahon, New York.

Gifford & Son, John A., New York.

Hoopes Bro. & Darlington, West Chester, Pa.

Jones & Co., Phineas, Newark, N. J.

Standard Wheel Co., Terre Haute, Ind.

Wheel Stock, Bent Wood, Etc.

Crane & MacMahon, New York.

Contractors Automobile Parts

**PLAIN
FINISHED
MACHINED**

CASTINGS

Write for a pair of our
Cast Metal Silver or Gold
Horse Bit Cuff Buttons **FREE**

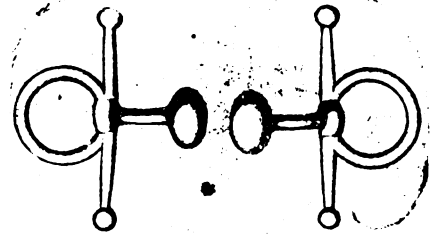

B^{Brass}_{Bronze} **A**^{luminum}_{Automobile} **BRONZE**

MANGANESE BRONZE

POPE'S ISLAND

Non-corrosive Metal, Silver and Gold; Best known metal

HAND CLOSE PLATING

Seven Colors, guaranteed to last the life of car, carriage or harness.

ELECTRO PLATING

Black, White, Gold, Silver, Nickel, Brass or Gunmetal

Contracts made with car manufacturers

Horse Bits

"If it's a bit, we have it"

LeCompte Mfg. Co.

E. A. Whitehouse Mfg. Co.

} **Inc.**

OFFICE

110 Chambers St., New York

FACTORY AND FOUNDRY

44-50 Elm St., Newark, N. J.

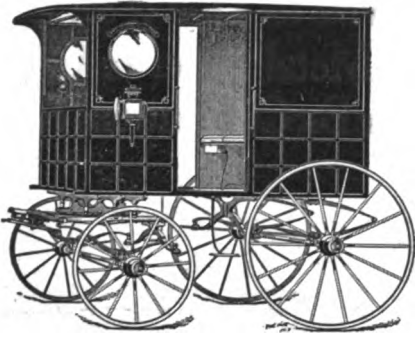

No. 112.—Milk Wagon.

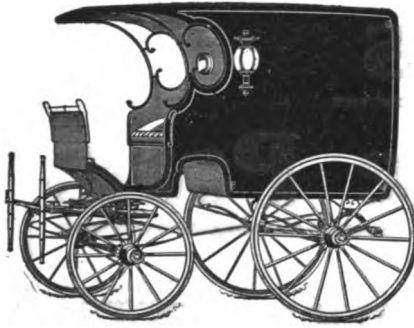

No. 111.—Altman Wagon.



No. 113.—Grocery Wagon.

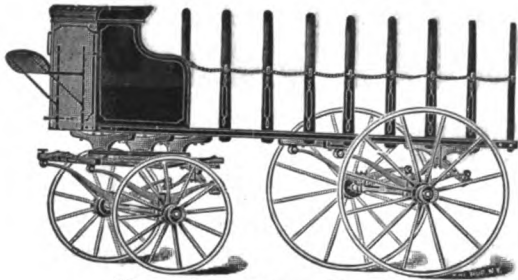

No. 122.—Flour Truck.



No. 116.—Milk Wagon.



No. 114.—Delivery Wagon.

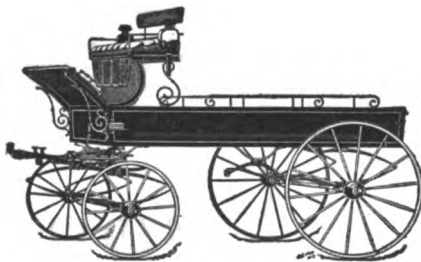

No. 124.—Delivery Wagon.

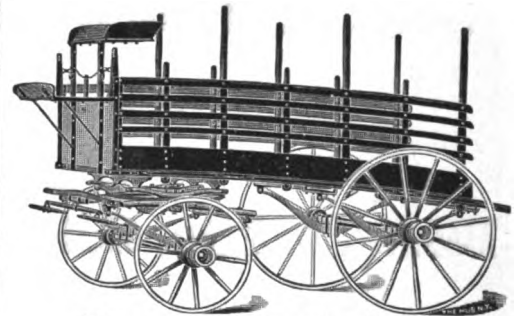

No. 117.—Merchandise Truck.



No. 118.—Ambulance.

Electrotypes

of the vehicles presented on this page will be forwarded on receipt of

75 cts.

for each cut, to any address. Postage prepaid.

Catalogue

containing nearly 200 illustrations of carriages, wagons, sleighs, and miscellaneous cuts will be sent upon application.

Trade News Publishing Co.
24-26 MURRAY ST.
NEW YORK

Please mention "The Hub" when you write.

F. W. DEVOE & C. T. RAYNOLDS CO.

101 and 103 FULTON STREET, NEW YORK

Manufacturers of

F. W. DEVOE & CO'S {
COACH COLORS
VARNISHES
BRUSHES
SPECIALTIES

C. T. RAYNOLDS & CO'S {
COACH COLORS
VARNISHES
BRUSHES
SPECIALTIES

FOR PAINTERS, ARTISTS AND DECORATORS

All the brands and specialties of F. W. Devoe & Co. and C. T. Raynolds & Co. will be maintained separately as heretofore.

WIRE WHEELS

TO FIT EMPIRE BALL BEARING AXLES

Quality Unsurpassed

Write Today

The Mott Wheel Works
UTICA, N. Y.

Brazil Leather

FOR AUTO BUGGY TOPS

SEAT AND BACK SPRINGS,
COTTON, NAILS, WADDING,
MOSS, TACKS, WASHERS,
HAIR, BUTTONS, REEDS,
REED MOULDING,
CLINCH BUTTONS

G. H. Lounsbery & Sons
Cincinnati, Ohio

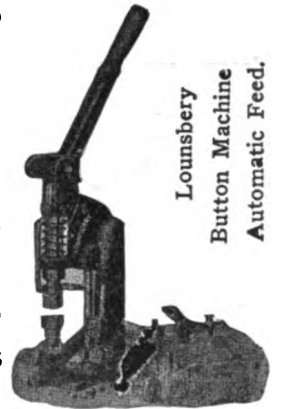

BOLTS Rivets, Carriage Makers' Washers
and Burrs for all kinds of Vehicles
Russell, Burdsall & Ward Bolt and Nut Co.
Main Works, PORT CHESTER, N. Y. Branch at Rock Falls, Ill.

Time Has Told the Story!

Service and satisfaction always follow our rolling stock

WHEELS

ALL KINDS—BEST QUALITY

Also RIMS and SPOKES

The Eberly & Orris Mfg. Co.
MECHANICSBURG, PA.

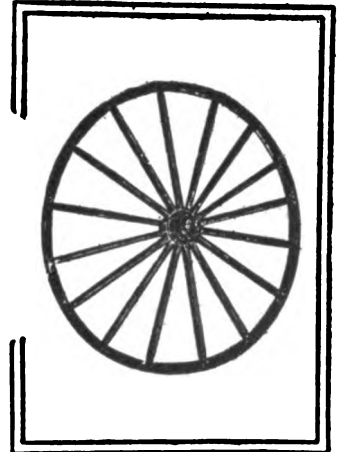
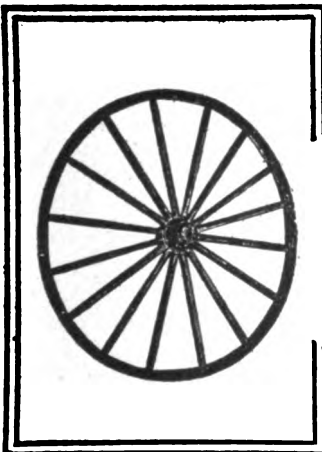

McKINNON DASH COMPANY.

TROY, OHIO.
CINCINNATI, OHIO.

BUFFALO, N. Y.

ST. CATHARINES,
ONTARIO.

ARE YOU

planning your 1911 Catalogue?

Consider the advantage of showing wing dashes with line rails, on all vehicle cuts. :: :: ::

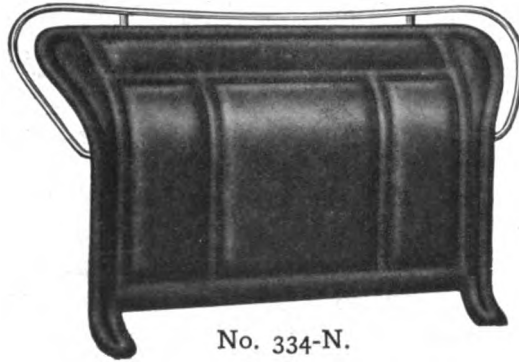

No. 334-N.

WHEN

describing quality of your work in 1911 Catalogue the statement "McKinnon Wing Dashes Used" will tell the tale. :: :: ::

Skewed Shaft Couplings

Regular or Oval Patterns
For High Arched Axles

Furnished in rights and lefts for any height of arch. Oval Axle Clips $\frac{5}{8}$ or $\frac{3}{4}$ width to match Oval Couplings. Bolts, Clips, Couplings, Carriage Hardware and Special Forgings

Catalogue "H" and Prices on Application.

COLUMBUS BOLT WORKS, Columbus, O.

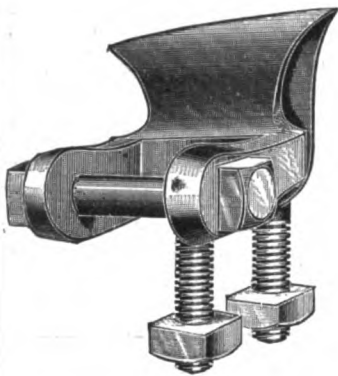

THE BRADLEY Carriage Coupler

All steel, Noiseless, Quick Shifting,
Ball Bearing.

The ONLY Carriage Shaft Coupler that is furnished with a
One-Piece Moulded Leather Packing

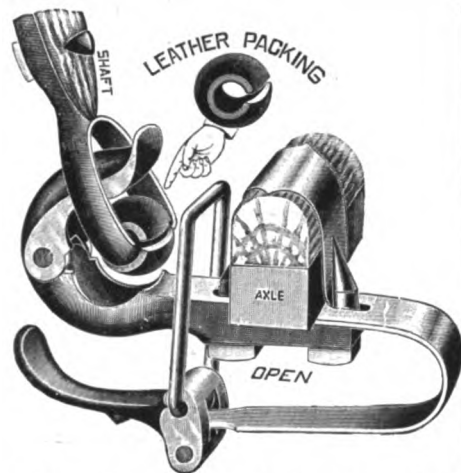

Placing the loop over the end of the cap and drawing the thumb lever back until it rests against the flat spring closes the coupler, keeps it closed, and takes up the wear of the leather packing.



Unless a Carriage Coupler is furnished with a moulded leather bushing and steel spring JUST LIKE THIS it is NOT a BRADLEY.

A packing that will outwear any other packing ever made. It fits the ball and socket. It is held in place by a spring steel retaining ring. It may be put on and taken off in a jiffy, and it stays where it is put.

C. C. BRADLEY & SON
SYRACUSE, NEW YORK.

The Hub

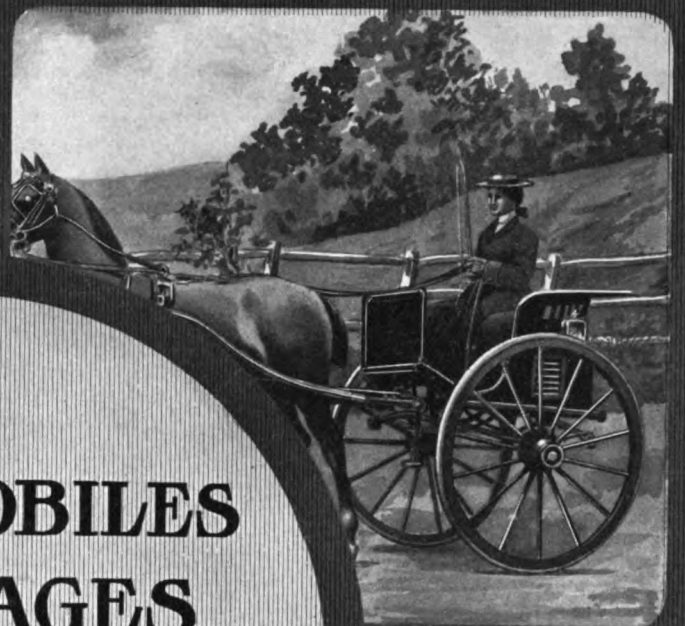

**AUTOMOBILES
CARRIAGES
MOTOR TRUCKS
WAGONS**

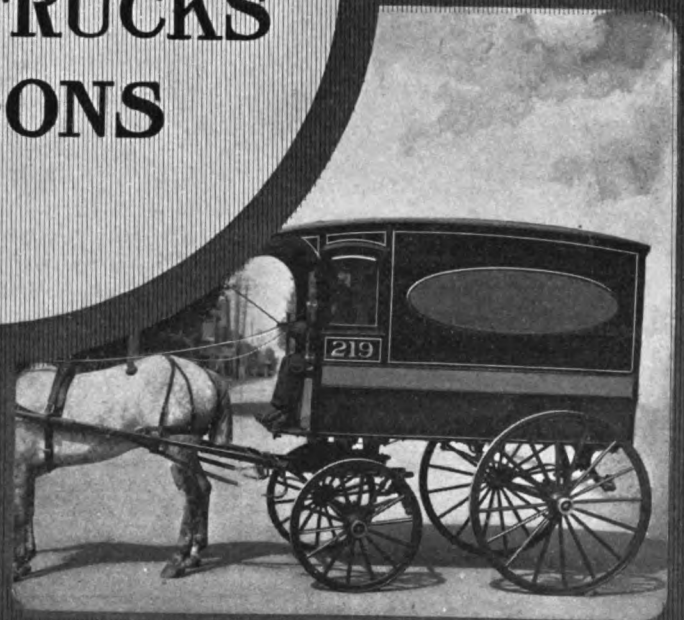

TRADE NEWS PUBLISHING CO
24-26 MURRAY ST., NEW YORK

Hoopes Bro. & Darlington Inc.

West Chester, Penna., U. S. A.

SARVEN
STAR or KENNY
Sweet Concealed Band
WOOD HUB
WARNER

WHEELS

HEAVY and LIGHT
for
CARRIAGES
WAGONS and
TRUCKS

IF YOU WANT THE BEST TRY OURS

The Output of Complete FRONT AND REAR AUTOMOBILE AXLES of this Plant Exceeds the Capacity of All Competition Combined.

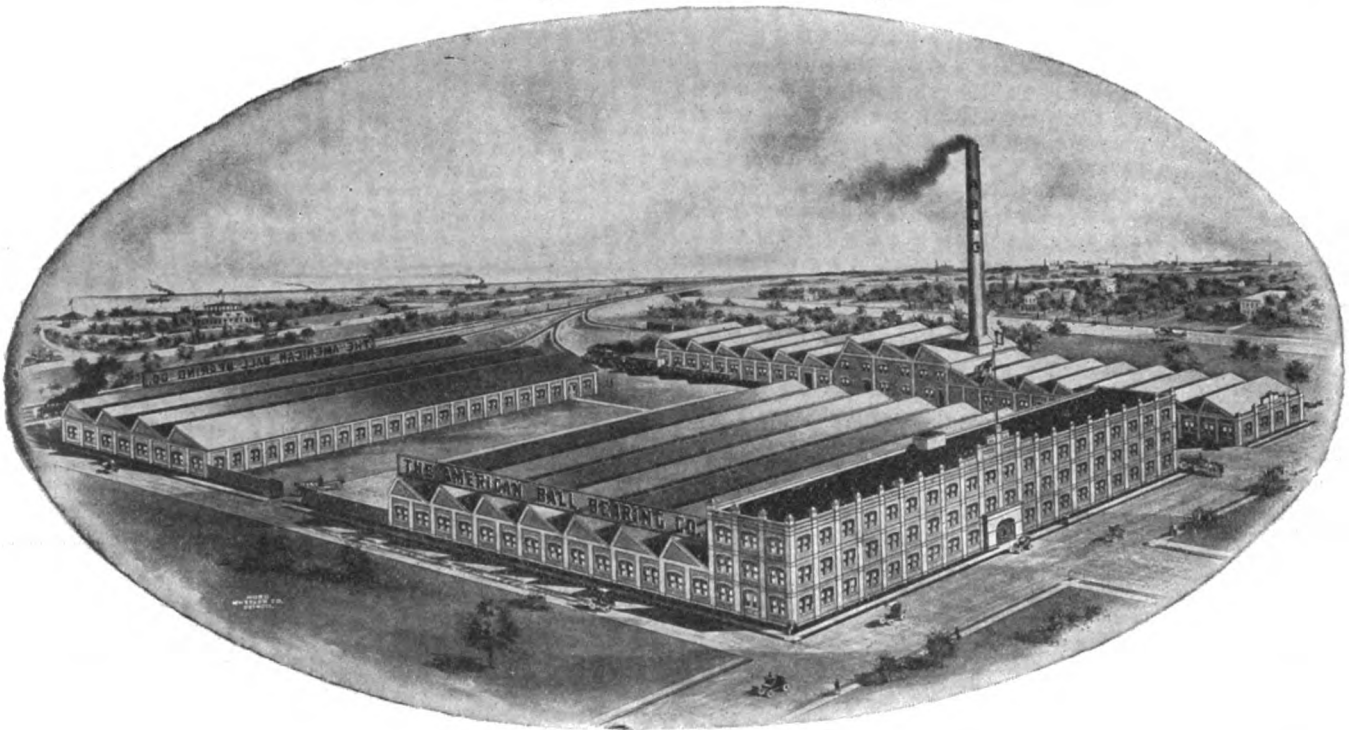

The American Ball-Bearing Co.,

L. S. & M. S. R'y and Edgewater Park.

CLEVELAND, OHIO, U. S. A.



CRANE & MACMAHON, (INCORPORATED)

8-10 Bridge St., NEW YORK CITY, U. S. A.

Sole Manufacturers and Exporters of the

HICKORY NUT,  ACORN,  and STAR  BRANDS OF

Carriage, Wagon and Automobile Wood Stock

FACTORIES:

ST. MARYS, OHIO. RICHMOND, VA.

For Export Prices apply to the New York office.

JOHN W. MASURY & SON

Manufacturers of

PAINTS & VARNISHES

Originators of
AUTOMOBILE, COACH, CAR and WAGON COLORS

Half a century of color making demonstrates to us the quality a varnish should possess to preserve and beautify color. For thirty years we have manufactured FINE CARRIAGE VARNISHES and know their superior qualities. Our Auto Varnishes are extremely pale in color, dry hard, presenting a tough surface that resists the elements and the action of dust, grease and oil to the greatest possible degree.

**For fifty years Masury's Colors have been the
STANDARD OF PAINT EXCELLENCE**

**"MASURY'S" VARNISHES OVER "MASURY'S"
COLORS INSURE THE BEST RESULTS**

JOHN W. MASURY & SON

NEW YORK

CHICAGO

MINNEAPOLIS

KANSAS CITY

DETROIT

Vanadium Color Varnishes

Standard Permanent Shades

FREE FLOWING QUICK DRYING

FOR

COACH, CAR AND AUTOMOBILE

THE HIGHEST QUALITY THE BEST ECONOMY

Trade **VALENTIN** **ES** Mark
VARNISH

VALENTINE & COMPANY

New York

Chicago

Boston

Toronto

Paris

Amsterdam

83 Years' Experience in Every Can



Edward Smith & Co.

CARRIAGE VARNISHES

Everything from the
Bare Wood to the Finishing Coat.

CHICAGO

NEW YORK

FRED BUSSE, Pres. and Treas. M. DANZIGER, Vice-Pres.
JOHN F. GOULD, Sec'y.

THE UNITED STATES VARNISH CO.

Visit Our
Factory
During the
Convention



We Want
You to
See How We
Serve Our
Customers

MANUFACTURERS FINEST VARNISHES

2616-2618 Colerain Ave.,

Tel. West 359.

CINCINNATI.

RUB ————— RUB ————— RUB

THAT'S THE EXPERIENCE SOME PAINTERS HAVE WITH A POOR RUBBING VARNISH. THEY RUB TILL THEIR HEART ACHES ONLY TO HAVE THE VARNISH SWEAT, OR ROLL UP UNDER THE PAD

XX Diamond Rubbing and Hard and Quick Drying Rubbing "A"

DRY HARD TO RUB IN TWO DAYS, WITHOUT SWEATING, ARE TOUGH AND THE BEST FOUNDATION FOR FINISHING COATS.

MADE BY **MOLLER & SCHUMANN CO.**

MARCY AND FLUSHING AVES.,

BROOKLYN, N. Y.

Please mention "The Hub" when you write.

“The A. & W. Co.”
Auto, Carriage and Wagon
Varnishes



THE QUICKEST THING IN
QUICK RUBBING VARNISH

USE IT AND SAVE TIME AND TROUBLE

The Ault & Wiborg Co.
Varnish Works

Cincinnati, Ohio.

CUT THIS OUT AND MAIL.

If you have
Varnish Troubles
 consult us. We
 probably have
 the remedy.

AULT & WIBORG CO. VARNISH WORKS
CINCINNATI, OHIO

Please send free of charge and prepaid,
 a Working Sample of “RUBFAST”

Name _____

Address _____

The Murphy Systems of Carriage and Motor Car Finishing are Simple, Scientific, Economical. Practical Painters Take to Them.

Let us give you a pocket booklet which explains the Murphy System Finish for Carriage Bodies, the Murphy System Finish for Carriage Gears, the Murphy System Finish for Motor Cars.

The best Carriage and Automobile Painters in the country declare these System Finishes A1 in every regard; and that they cost less than second-class finishes.

Murphy Varnish Company

FRANKLIN MURPHY
President

NEWARK

BOSTON

CLEVELAND

ST. LOUIS

CHICAGO

Associated with Dougall Varnish Company, Limited, Montreal, Canada

The Varnish That Lasts Longest

WILLEY'S COLORS

The **RECOGNIZED STANDARD**



C. A. WILLEY CO.

COLORS GRINDERS

and Manufacturers of Specialties in

CARRIAGE, AUTOMOBILE AND CAR

PAINTS

COLORS, VARNISHES, ETC.

HUNTER'S POINT, NEW YORK CITY

KIMBLE'S FAMOUS GEAR WOODS

still represent the highest standard of excellence and quality. True to our motto our line wins the approval of all vehicle builders.

WHAT CAN WE DO FOR YOU ?

ANDREW KIMBLE

ZANESVILLE, O.

KEYSTONE BLACK FILLER

MAKES A PERFECT

ROUGHSTUFF

For Automobile Bodies and Parts

It fills the pores of Metal and Wood perfectly. Sandpapers easily and produces a fine, smooth surface that DOES NOT CRACK, SCALE NOR PEEL.

POMEROY & FISCHER, New York
Selling Agents to Vehicle Trade

KEYSTONE PAINT AND FILLER CO., Muncy, Pa.

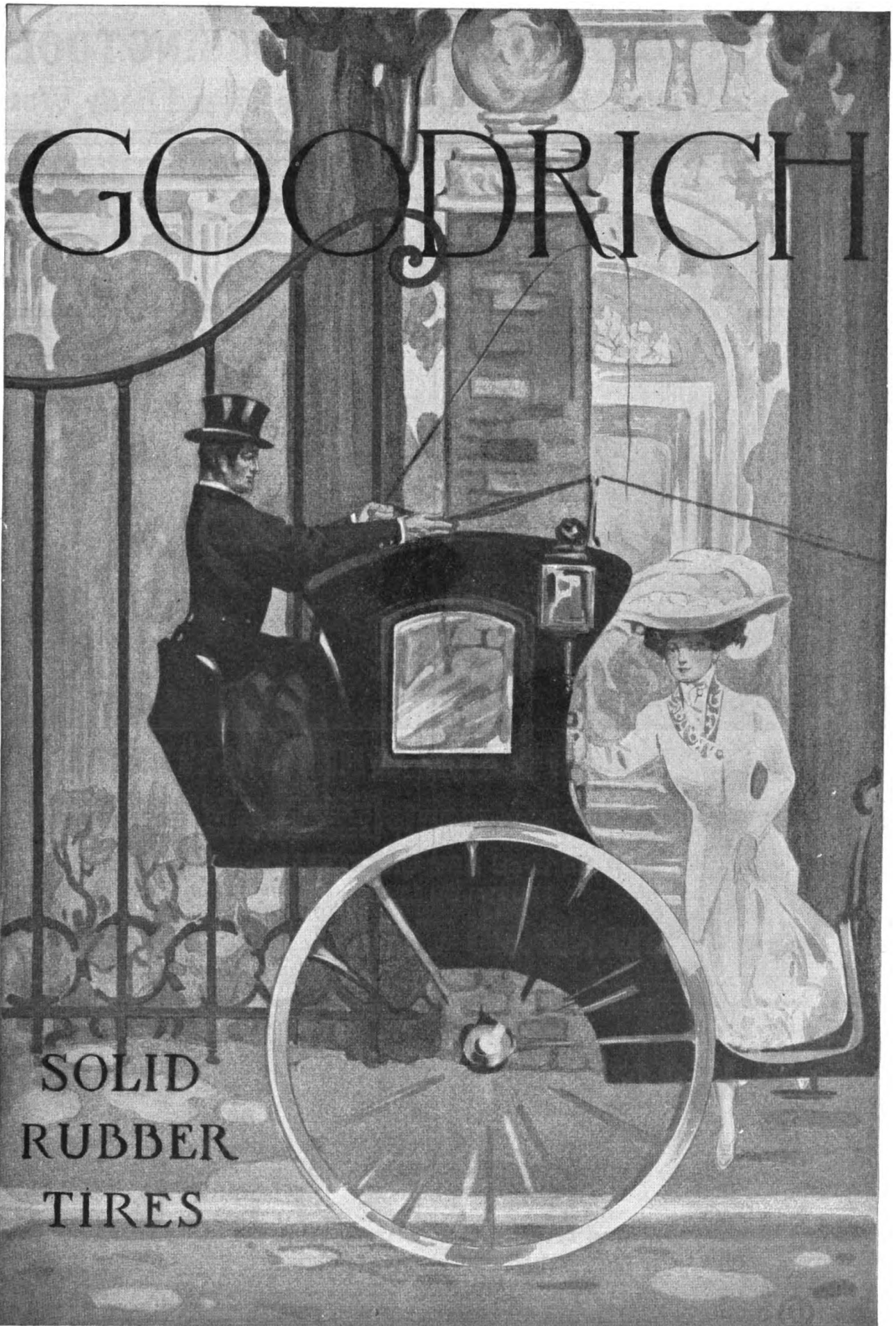

SOLID
RUBBER
TIRES

HAMILTON-OHIO-LINE, WOOD-WORKING TOOLS

For Carriage, Wagon, Hub, Spoke, Rim, Wheel and Body Work

Disk Sanders, Belt Sanders, Spoke Sanders, Wheel Sanders, Gear Shapers, Scroll-Eying Machines, Gear Rounders, Spring-Bar Boring Machines, Seat-Back Benders, Rim Planers, Rim Rounders, Rim Borers, Rim Cut-Off Machines, Wheel Boring and Screw Driving Machines, Spoke Lathes, Spoke Cut-Off Saws, Spoke Tenoning and Mitering Machines, Spoke Throaters, Spoke Facers, Wheel Facers, Wheel Tenoners, Hub Lathes, Hub Mortisers, Hub Borers, Wheel Boxers, Wheel Presses, Tire Truers, Tire Bolters, Spoke Cut-Off Machines, Band Saws, Rip and Cross-cut Saws, Planers, Matchers, Moulders, Shapers, Boring Machines, Universal Wood Workers, etc.

THE BENTEL & MARGEDANT CO. HAMILTON, OHIO, U.S.A.

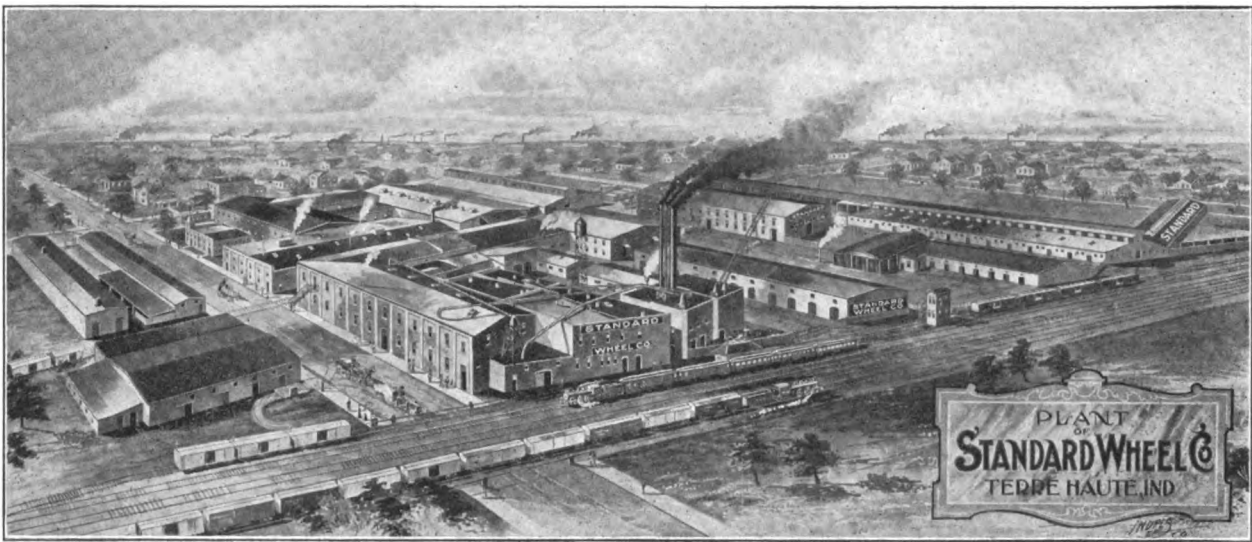

VEHICLE WHEELS AND WHEEL MATERIAL

Three Separate Departments [Light Carriage and Buggy Wheels
Heavy Express Wagon and Truck Wheels
Automobile Wheels

OUR GRADES ARE UNEXCELLED

WRITE FOR LIST.

Terre Haute, Ind. STANDARD WHEEL CO. Terre Haute, Ind



Eagle White Lead Co.

INDEPENDENT OF ALL COMBINATIONS

The Largest Lead Products Plant in the World.

CINCINNATI, OHIO.

CORRODERS BY THE OLD DUTCH PROCESS.

WHITE LEAD

THE ABOVE BRAND OF WHITE LEAD HAS BEEN ON THE MARKET FOR UPWARDS OF SEVENTY YEARS.

MINNEAPOLIS, Twin City Paint Co.
NEW YORK, 100 William St.
PHILADELPHIA, 142 No 4th St.
CHICAGO, 415-17 North Peoria St.

BALTIMORE, 447 North St., G.O. Shivers, Mgr.
BUFFALO, Builders' Ex., A. S. Goltz, Mgr.
KANSAS CITY, 600 Victor Bldg., G.P. Moore, Agt
PITTSBURG, Pittsburg Paint Supply Co., Agts

NEW ORLEANS, John R. Todd & Bro., Agents.
ST. LOUIS, R, 405 A. Benoist Bldg.,
B. P. Temmeyer, Mgr.
CLEVELAND, The Hale & Holmes Co., Agents.
BOSTON, 60 Broad St., E. W. Osborne, Mgr.

Please mention "The Hub" when you write.

The

Hub

Copyright, 1910, by the Trade News Publishing Co. of New York.

Entered in the New York Post Office as Second-class Matter.

Vol. LII.

SEPTEMBER, 1910.

No. 6.

THE TRADE NEWS PUBLISHING CO. OF N. Y. Publishers of THE HUB

J. H. WRIGHT, *President.*

G. A. TAMMER, *Secretary and Treasurer.*

24-26 MURRAY STREET, NEW YORK.

Other Publications of Trade News Publishing Co.:

HARNESS (monthly)per year, \$1.00
AMERICAN HARNESS AND SADDLERY
DIRECTORY (annual)per copy, \$4.00

THE HUB is published monthly in the interest of employers and workmen connected with the manufacture of Carriages, Wagons, Sleighs, Automobiles and the Accessory trades, and also in the interest of Dealers.

Subscription price for the United States, Mexico, Cuba, Porto Rico, Guam the Philippines, and the Hawaiian Islands, \$2.00, Canada, \$2.50, payable strictly in advance. Single copies, 25 cents. Remittances at risk of subscriber, unless by registered letter, or by draft, check, express or post-office order, payable to the order of TRADE NEWS PUBLISHING Co.

For advertising rates, apply to the Publishers. Advertisements must be acceptable in every respect. Copy for new advertisements must be received by the 25th of the preceding month, and requests to alter or discontinue advertisements must be received before the 12th day of the preceding month to insure attention in the following number. All communications must be accompanied by the full name and address of writer.

FOREIGN REPRESENTATIVES:

FRANCE.—L. Dupont, publisher of *Le Guide des Carrossiers*, 78 Rue Boissiere, Paris. Subscription price, 15 francs, postpaid.

GERMANY.—Gustave Miesen, Bohn a Rh. Subscription price, 12 marks, postpaid.
ENGLAND.—Thomas Mattison, "Floriana," Hillside Avenue, Bitterne Park, Southampton. Subscription price, 12 shillings, postpaid.

Woodstock Scarcer.

A local organization has been recently put in operation covering the states of Missouri, Illinois and Indiana, by carriage and wagon woodwork makers, under the name of the Wagon and Carriage Woodstock Club.

Like similar associations in other sections the aim is to conserve timber used for the purposes above stated, and we would judge, also to increase prices that are thought to be not in line with demand and a scarce supply of the raw material.

Fifteen years appears to be the limit set for the exhaustion of the supply of wagon lumber if present methods are not changed in some way. The precise number of years for the limit of supply seems to be of general acceptance among the makers of carriage and wagon stock. How the limit is calculated we would like to know as a matter of much interest. We are inclined to believe, though, that some one thinking manufacturer has hit upon this figure and others have adopted it. The last government records we saw would lead us to think the situation not so strained. The government experts give color to the idea that the supply is somewhat plentiful yet, but it may be in localities where it cannot be cheaply cut out.

We have heard it stated by makers of wagon stock

in private conversation that they were not troubled to get the kind of stock wanted in quantities to meet demand; others have taken the opposite ground, but all seemed to have plenty of fine material.

There has no doubt been most extravagant waste. There is no doubt it is now realized. It is plain that that the government is doing what it can to conserve resources. But the makers appear to get plenty of stock at a price. Perhaps that is the trouble, price. It seems to be a task to raise prices in the trade, notwithstanding the quality and the processes of manufacture turn out better finished material all the time. We don't suppose there is a trade where such good stuff can be bought for so comparatively a small sum of money. Competition is strong even when combination has taken place. Co-operation seems to be the lacking element. There are enough associations, national and local, to bring this about, we would think.

The Trade in Buggies.

The buggy maker is said to be having a very good business this year. If it is slow at present owing to the general letting up in mercantile affairs, he has at least planted the largest end of his season's output, and the dealer has no doubt worked off a very fair percentage of his purchases. So the season, so viewing it, must be accounted good for the builder.

A little while ago there was a cry that the farmer had forgotten how to use farm wagons, or was taking better care of those in use, because the demand for new work was not what it seemed it should be. However it may have come about we don't profess to know, but the farmer became suddenly interested in wagons once again, and there was a satisfactory movement of new work.

Fact is the vehicular needs of this wide land are varied and extensive, and all the kinds in use seem to be none too many to meet requirements. If anything could be overproduced it would seem to be the ordinary buggy. Its volume of sales each year are incredible to the uninformed, and while the output fluctuates somewhat from year to year, yet its aggregate is something to marvel at. We are so accustomed to the figures we are not impressed.

The vehicular needs of the community seemed well supplied before the automobile came upon the scene, yet here is a vehicle being supplied in the hundred thousands on top of an already vast vehicular supply, and it is absorbed somehow. Meantime the foot passengers appear to be as numerous as usual. The approaching census

figures will account for much of the marvel. We have been producing a "right smart" lot of people in this ten-year period since the last enumeration, and they are spenders like all who preceded them and have a distinct preference for riding over walking, with as much speed "on the side" as the money will buy, so we seem to be able and ready to absorb products as a sponge does water.

The season's buggy business has been good. If the crops are also good, there will be yet more buggies wanted, even if they are not needed.

There seems to be one feature of the marketing of factory made work that is encouraging. The goods are being sold for just what they are, and not represented by the dealer to be something they are not. The value for the money is and has always been, very great, and there is no good excuse for misrepresentation. It is drifting in on the mind of the dealer that it is not good business policy to misrepresent. This better way of merchandizing his stock will be a winner in all directions. He will hold his trade steadfastly by such a policy; and it will not be a strain on his memory to remember what he represented to his customer when he sold the job, because he stated facts that are the same to-day as on the former day of sale. All high class merchants so trade nowadays, and the dealer is putting himself in that class rapidly. It is good all around.

Increase in Price.

The Carriage Manufacturers' Association, which comprises many of the big factories), has met in Louisville to discuss an advance in the price of vehicles owing to increased cost of production.

It was agreed to so act, but the rate of advance is withheld for a later announcement.

There have been many tentative efforts to bring about a working plan for an advance, because the handicap of increasing cost is nothing new or recent, but, somehow, the line could not be laid down in a manner that was satisfactory or practical, it would seem, as the results were nil up to the present time. Probably the force of circumstances is now forcing agreement as to a rise in prices. This does not mean a concerted and agreed price advance, we take it, but an advance that each maker will adapt to his own work and needs.

The Motor Share Market.

Abroad they have been quick to realize the stock market possibilities of motor shares. In England we note that more than thirty kinds of shares are listed and dealt in on the exchange. The fluctuations appear to be speculative in character. The dividends range from nothing to 33 per cent, the latter a tire concern. We could make up a very respectable list as regards length, if some day the companies should put their shares on our "curb" market among the unlisted stocks. They would be a safer gamble, perhaps, than the bulk of the mining stocks that seek that market.

The Motor Cycle.

Not much has been said about this noisy and rapid two-wheeled vehicle, but its progress has been great. As yet it is, or appears to be, forbidding to the sporty feminine, but the young man who courts chances has found the sport all his heart could yearn for.

The speed maniac can get more thrills from it per mile than any racing automobile can supply. And he can make rings around the auto when it comes to getting over the face of the earth in quick time.

The industry has made noteworthy strides in production. There is a very large variety of makes to choose from.

Save for speed and sport we have not learned what it is good for, but in time its economic capacities may develop. Meantime the number is growing and the industry seems prosperous. It is a great time for vehicles and extravagances of all kinds. The impetus may result in great good when we cool off a little.

In Germany.

Our German friends are about the most progressive people in business anywhere. It won't do to say they are up-to-date, as it is no compliment to a people who come pretty near to antedating the efforts of other "smart" people, most of the time.

The Berliners were early in the taxi-cab business, soon saw that it was a shabby vehicle in its accepted form, and at once dropped it for something more elegant. Their motto must be "the public be pleased," judging by what we see in every direction when looking over Germany.

High Quality Steel.

We think the automobile maker will have to be given credit for stimulating improvements in the static and dynamic qualities of steel. He has been hypercritical about the metal he uses, and willing to pay the steel maker for the kind desired. The steel maker has been spurred to great effort and experiment, and has made great strides. In this way the motor car has been a benefactor to all sorts of metal users, as they can procure more kinds of steel that will stand more kinds of strains than ever before.

Advance in Paint and Varnish Prices.

Probably owing to the sharp advances in price of the raw material of the varnish maker, many paint and varnish manufacturers are out with circulars announcing advances in prices.

In all the rise in commodity prices during recent years, paints and varnishes have remained about stationary, so it was full time for the effect of increasing values to manifest in these days.

AUTOMOBILE LAWS.

Mr. J. B. R. Smith, Commissioner of Motor Vehicles, of New Jersey, delivered an address on automobile laws, August 10, to the members of the Automobile Club of America, at the club house in New York City.

Vehicle Fashions for September 1910

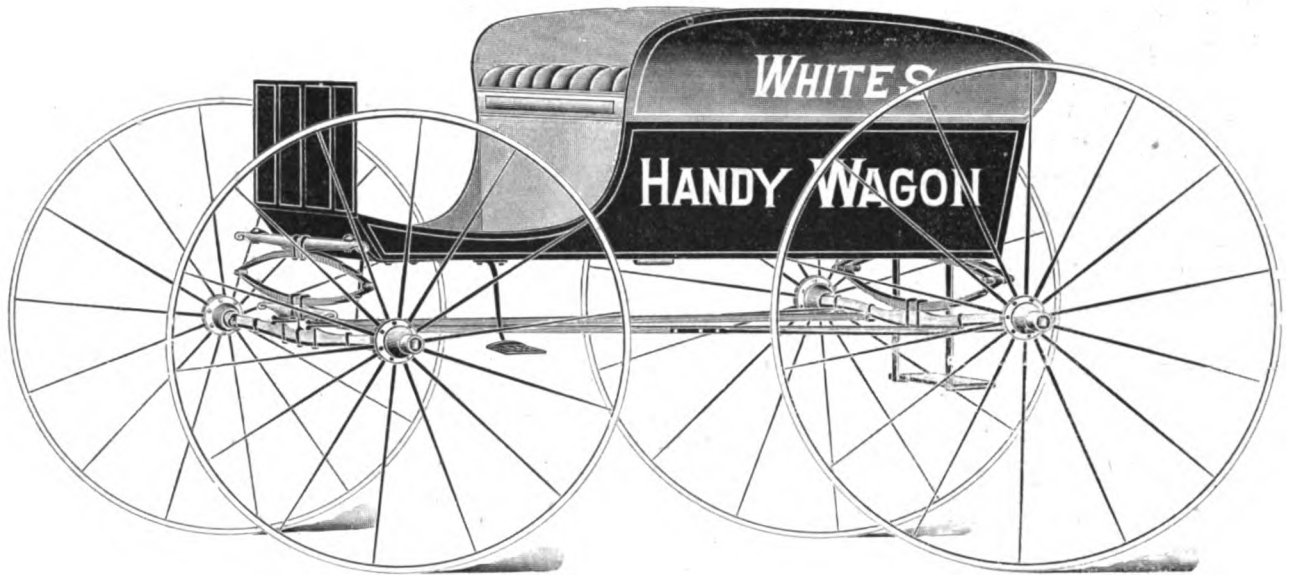

Made by Geo. White Buggy Co., Rock Island, Ill.

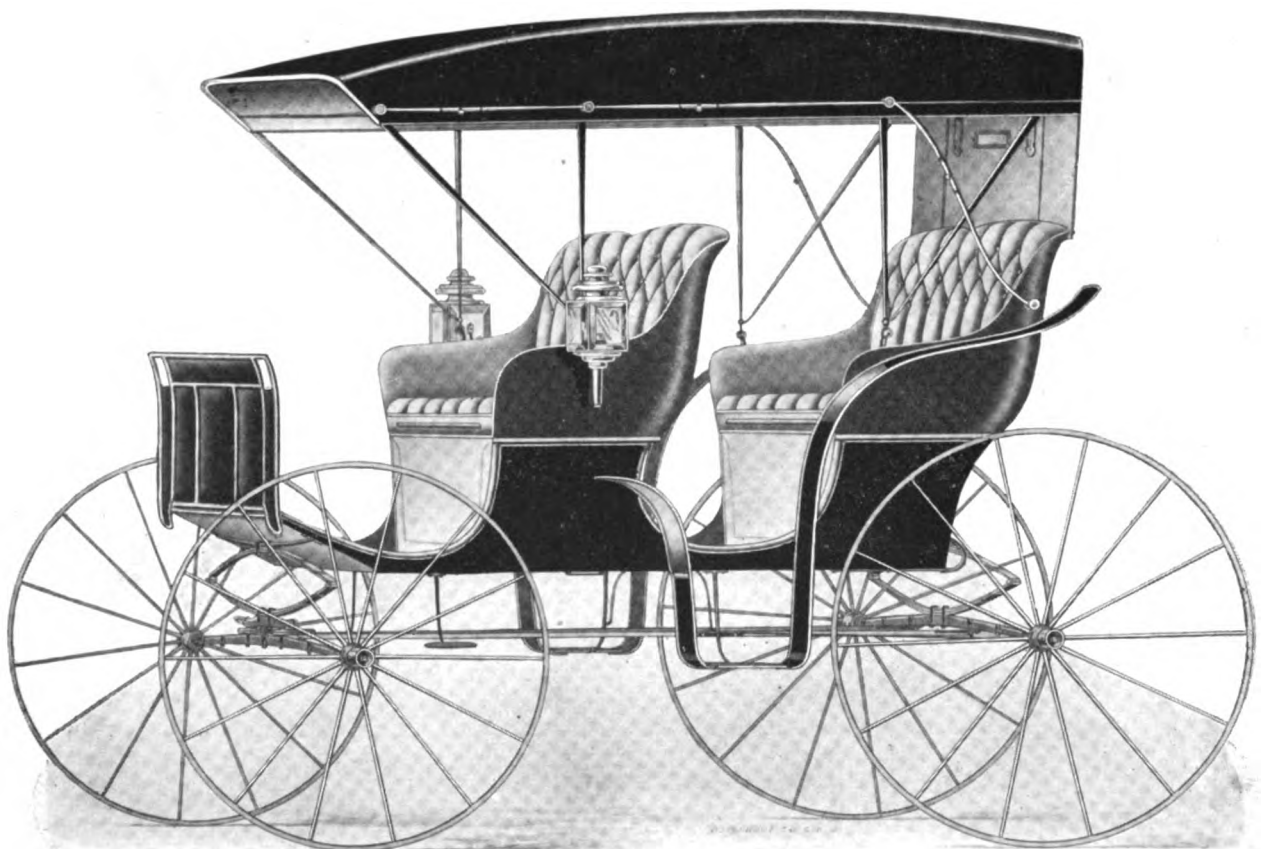

Made by Geo. White Buggy Co., Rock Island, Ill.

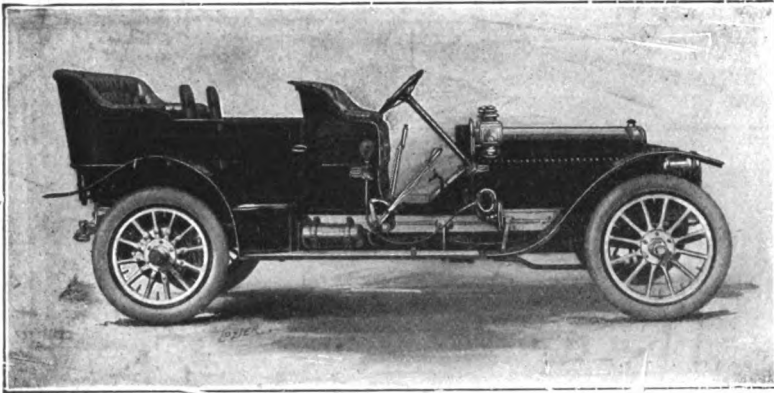

Made by Lozier Motor Co., Plattsburg, N. Y., Detroit, Mich.

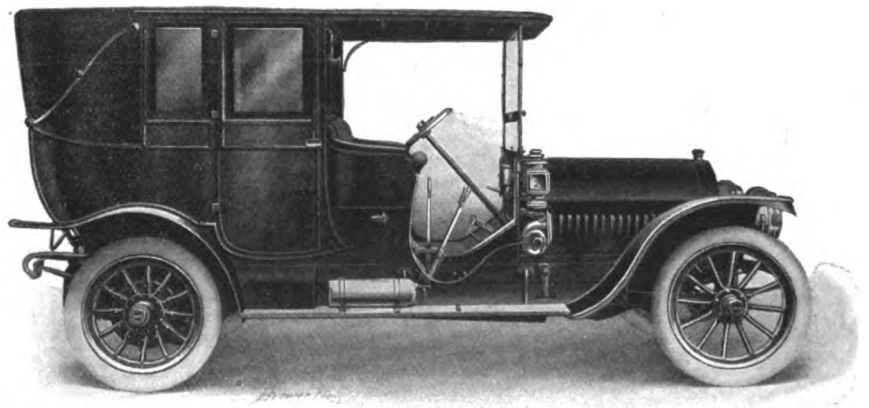

Made by American Locomotive Co., Providence, R. I.

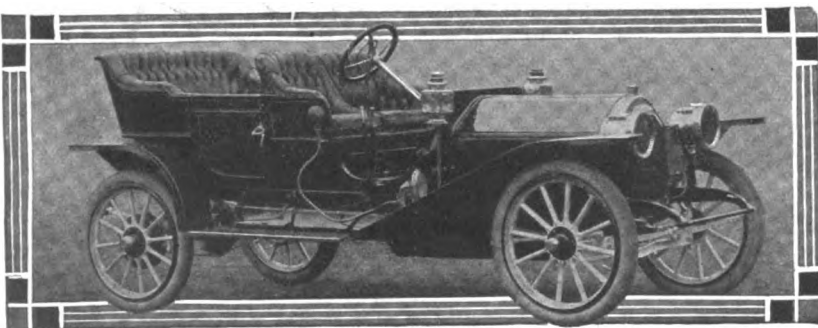

Made by Parry Co., Indianapolis, Ind.

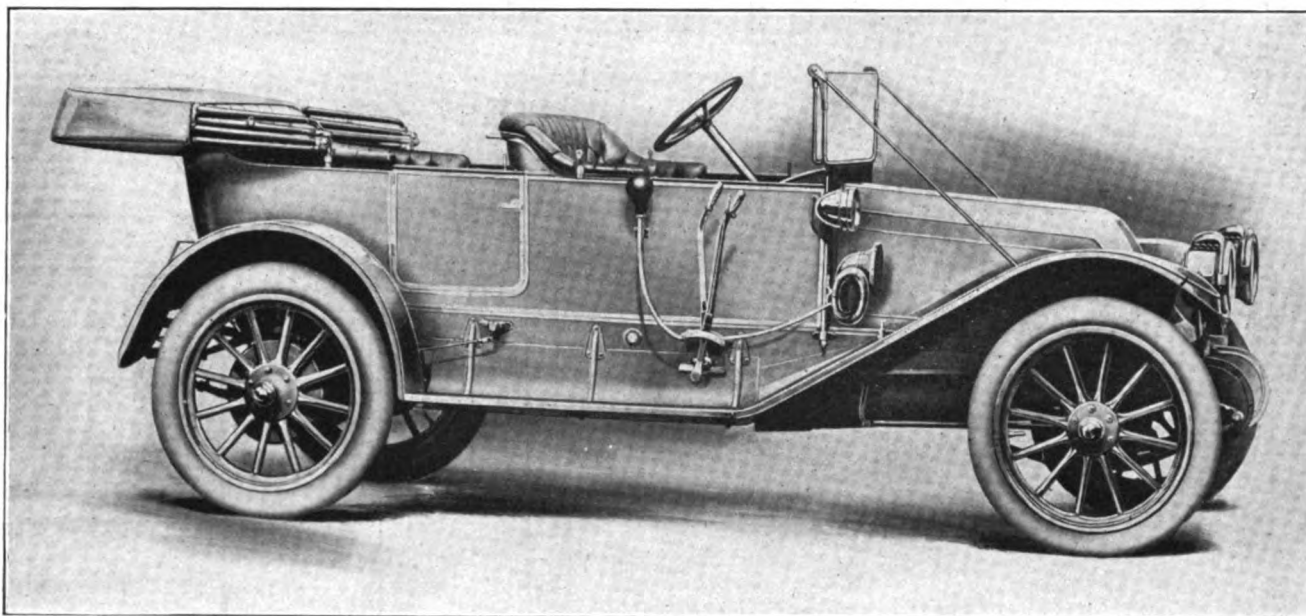

Made by Franklin Automobile Co., Syracuse, N. Y.

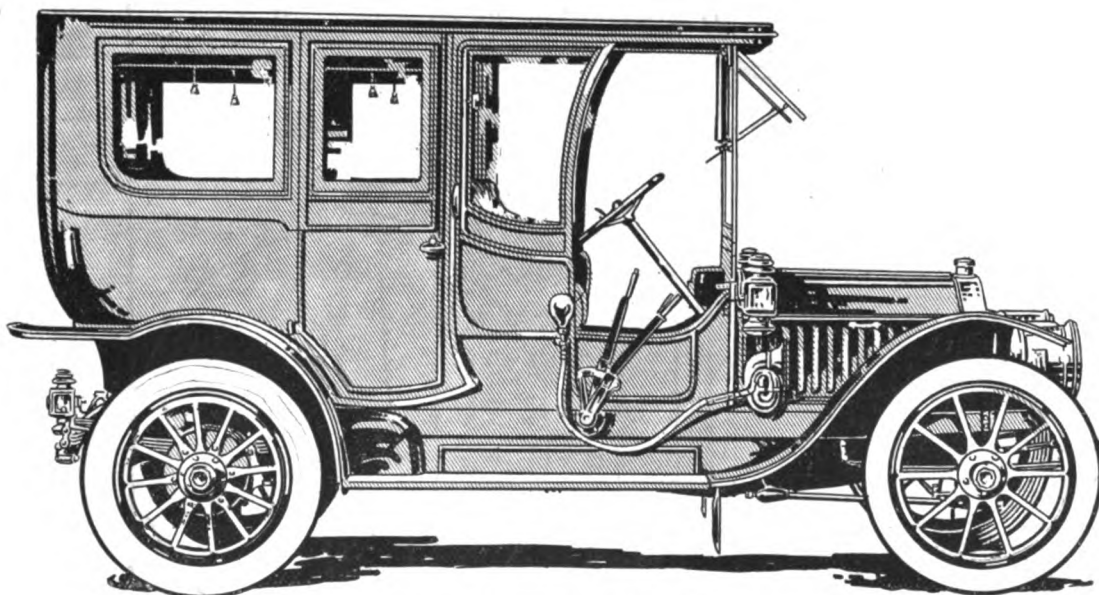

Made by Peerless Motor Car Co., Cleveland, Ohio.

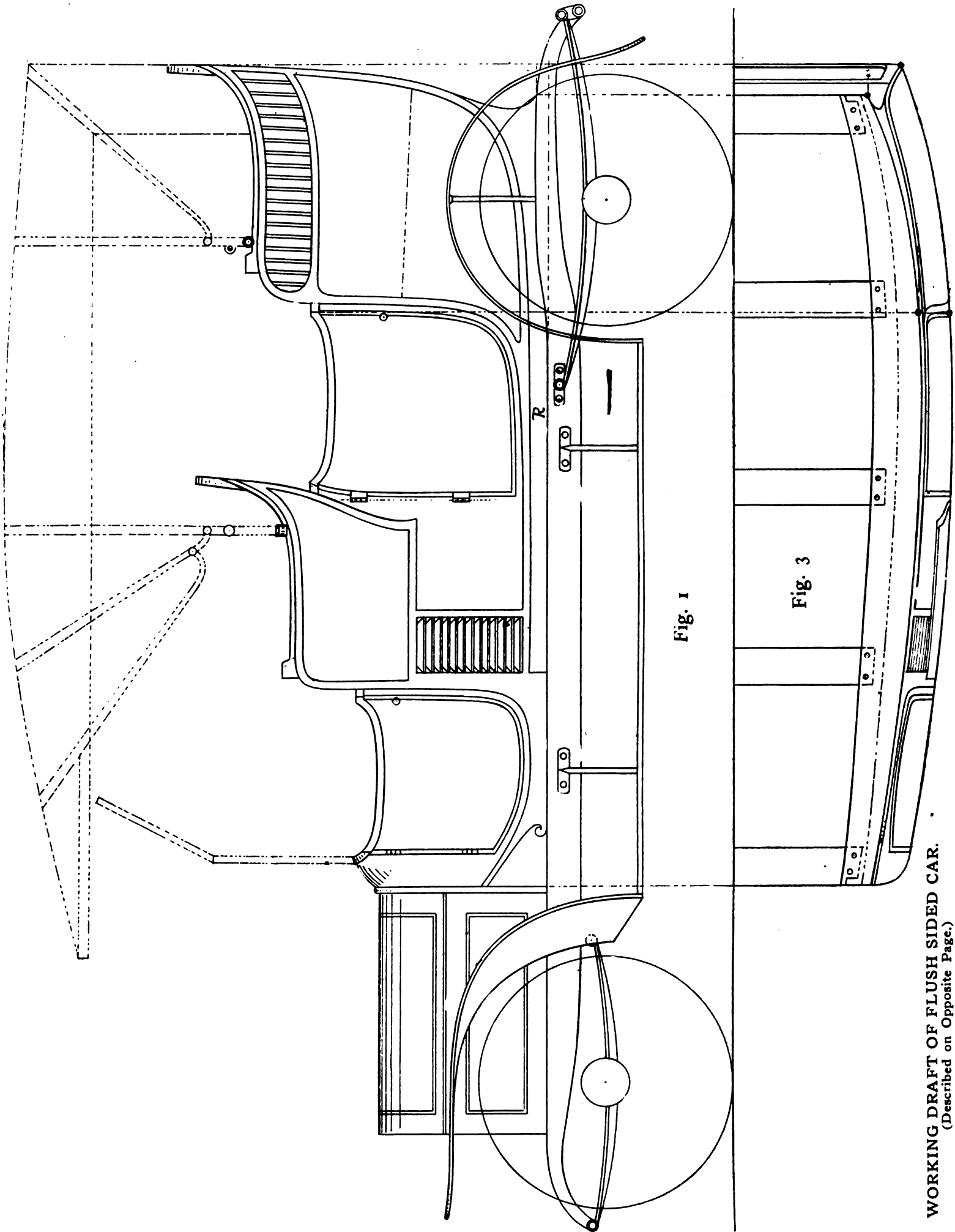

Fig. 1

Fig. 3

WORKING DRAFT OF FLUSH SIDED CAR.
(Described on Opposite Page.)

Wood-working and Smithing

WORKING DRAFT OF FLUSH-SIDED CAR WITH HOOD.

(Drawing on Opposite Page.)

The design in the draft is of heavy cab phaeton quarter behind with belt panel to cut up its depth. The corner pillar line is at a slight angle, running into the bottomside corner curve, which finishes faintly on the chassis line of the body. The door is made to follow the front of the pillar line, and hinged to the standing pillar at front quarter line.

The front top quarter is Victoriaed, which lends itself to the

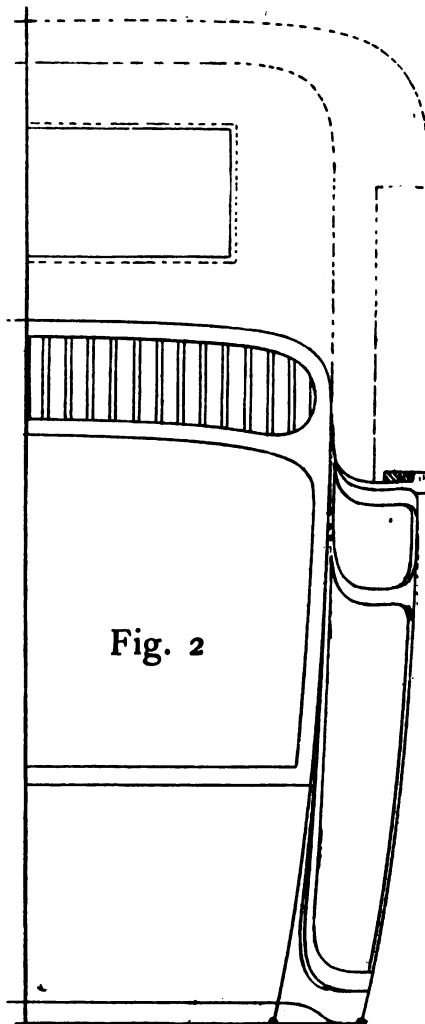

where motor car manufacture, as an internal and export commerce, has been taken up.

The rocker line of the body is made to conform to the design of the chassis, which is curved up behind to give a greater clearance span to the spring's hanging.

The hind wings are arched to the curve of the wheels, which allows a freer passage to the body and a clearer view of its outline, while at the same time, a more correct and proportionate size of door is obtained, and its opening and shutting is enhanced in direct opposition to the mutilation that doors are subjected to in motor body design. The hood is made with canopy top and open sides.

The elevation Fig. 1 shows a design of body replete in lines of a snug and graceful boundary, and away from the common plane of general output. The lines have been quickened and extended in harmony with each other to the completion shown in the design of the working draft. Those who desire to always keep ahead of the beaten track must constantly confront themselves with the problem of breaking up new ground in presenting their manufactures to a buying public.

Fig. 2 shows the half back view of the body, and the design of its mouldings, and panelling together with the widths of body on bottom, on elbow points, and across top of front pillars in projection. The line of the hood and its covering is shown in dotted outline from which it will be seen quite fully how the fitting is put up at the bench.

Fig. 3 shows the half plan of body, which it will be seen is level sided and of one regular side sweep, which brings its construction into line with that of a landau, while the turn-under is measured off in the same way but parallel from point to point in the body's length.

The bottomside is also side curved on the inside. This is done from an economical standpoint, so that one bottomside could be cut to curve into the other without waste, and also to save weight in the framing, because the bottomside cuts into weight when got out with a straight inside edge, but it is, of course, all the stronger for the extra timber.

In this particular the chassis line is shown in dotted line to follow the turnunder side curve of the body. By this plan, the projection of the body over the chassis is narrowed, and there is no reason why a chassis should not be got out in its width to follow the lines of the body's construction as shown in the plan.

There is no difficult construction in the body. Its build makes a comparatively simple job to those with individual seat designs and distorted construction. The body's build calls for good workmanship, while the technicalities of finding difficult constructional lines have been very much cut down to a normal level of comprehension.

The plan shows the divisional sections of the body at its widest part and the correct line of the turnunder and its return to the width across the back at elbow point. The bottomside is got out of a solid depth to the lines of the door bottom on the elevation but it should be one-quarter inch deeper than this to allow the shutting check of the door rabate being worked up. This depth is carried to the back quarter corner pillar, which is slip-tenon-framed to the bottomside and the panels grooved in. The front quarter panels are made in the same way in top and bottom quarters. The bottomside is forced back 5-16 inch to show the body's moulding outline up and to form the rocker as shown in the elevation, Fig. 1. The full line of the turnunder is shown in the plan, the rabate check back for the rocker R is not shown here, but is explained here to prevent confusion.

The sizes for building are as follows: Length of body on

fashioning of a good door entrance, and a smart compactness, which harmonizes with the whole character of the body's outline. The narrow pillar quarter to which the door is hinged, is got out in the solid and made to form the rocker piece of the bracket. The front quarter boot is made with Venetian paneling, or they may be made in the solid, and the panel half check-framed to the framing pillars. The solid method serves the purpose of a Venetian panel while it keeps the body free from air draught, but the individual framing of the Venetian slats into the side pillar framing is a method still largely followed in high class carriage building. The belt rail panel on the hind body quarter is finished in square spindling, which is fixed to the panel with pins. Or the panel may be done in stripping, which is widely resorted to in the trade in almost every country,

chassis line from bracket to rocker point, 8 feet 5 inches; width of hind quarter on elbow line to door check, 31 inches; width of door on the square line, 23½ inches; depth of door at center, 23½ inches; depth of quarter on door line over rocker to underneath moulding of belt panel, 29 inches; depth of belt panel over mouldings, 7¾ inches, on seat line to door, 29½ inches. Width of front quarter on elbow line, 26 inches; on seat line to door check 22½ inches. Depth of bottom quarter over rocker to top Venetian line, 16½ inches; depth of rocker, 2 inches; width of Venetian panel over moulding, 8 inches; length of bracket bottomside over eye, 20½ inches; width of front door, 20 inches; depth of ditto at center, 18½ inches.

Depth of front top quarter over mouldings on front pillar line, 15½ inches; at back on vertical slat line, 16½ inches; on corner pillar line at moulding point, 23½ inches; width of bonnet quarter piece, 4½ inches; depth to curve point of pillar top, 24½ inches; width of body on rocker line, 34 inches; across door line, 46 inches; across top of pillars, 54 inches; across front at door line, 36 inches; at front point, 35 inches; across back of body on elbow point, 40 inches. Depth of canopy hood from hind seat on pillar line, 49 inches; over vertical slat from top of seat, 51 inches; fall of hood on bonnet line, 10 inches; projecting width of horizontal slat from hinge center, 27 inches, and projects over the engine bonnet 10 inches. The hood is made to stand clear of the body at vertical slats, 4½ inches.

TO HARDEN AND TEMPER STEEL.

To one gallon of common fish or whale oil, take one pound each of beeswax and resin. Put into a kettle and heat till it comes to a boiling point, stirring it once in a while. When thoroughly mixed it is ready for use.

To harden in this solution, heat the steel till the scale rises a little, then immerse in the oil. When cool, heat over a clear fire till cherry red in the dark, says the American Blacksmith.

The foregoing, with a little practice, is recommended as one of the best compositions for hardening steel tools for use in cutting iron or wood, or even steel. Care must be taken as to the amount of resin in the oil, as resin hardens the steel, whereas beeswax and tallow toughen it. If a person prefers to temper in daylight, clean the steel or tool, polish it, and draw to a deep straw color, if for cutting iron or steel, and purple if for wood-cutting tools.

GAS ENGINE PRESSURES.

Following are the pressures which are usually used for internal combustion engines for different fuels. These vary, however, to some extent, depending on the speed and type of engine:

Gasoline and kerosene, 60 to 70 pounds per square inch.

Alcohol, 100 to 150 pounds.

Natural gas, 75 pounds.

Artificial gas, 100 pounds.

Producer gas, 175 pounds.

A spark should have an advance of about five degrees for every 100 pounds per minute.

BRAZING COMPOUND FOR STEEL.

The following formula makes a good compound for brazing steel and when the brazing is completed but little filing is necessary, as the scale formed is very loose:

Boracic acid, 3 parts, by weight; borax powdered, 1 part, by weight.

The borax must be calcined or melted before mixing. Use a ladle in melting the borax, and after it cools reduce to a powder. Mix with the acid and apply as a paste with water.

To make a file take hold better, dip it occasionally in gasoline. Have a bottle full of the liquid handy, but always keep it corked to prevent its rapid evaporation.

HOW TO MAKE A FOOT POWER HAMMER.

"Here is a description of a very useful tool which is designed and made by a subscriber of the American Blacksmith, to which we are obliged for the illustration. It is a foot-power hammer, made with an ordinary blacksmith's sledge. A is the anvil; B the sledge with a square handle; C the iron to hold the sledge handle to C; D is a 12-inch brake spring; E is a clamp to hold sledge handle to C; F is a hardwood plank, 12 inches by 24 inches, securely fastened to the floor, and contains a mortise to receive the post, G; H is a round piece of iron 1½ inches in diameter, flattened at I to about 2½ inches wide; C is split and goes each side of I and is bolted. The distance from I to the hook at the top end of H is 18 inches. This part can be bent back to give the hammer any amount of sweep desired. A brace, J, holds the hammer post securely, and is fastened to the post by the bottom grip at K, which passes through it. The grip K should be drawn tight against the wood at the backside, so as to be solid and let H slide easily. The grip, L, should be set into the post, G, so

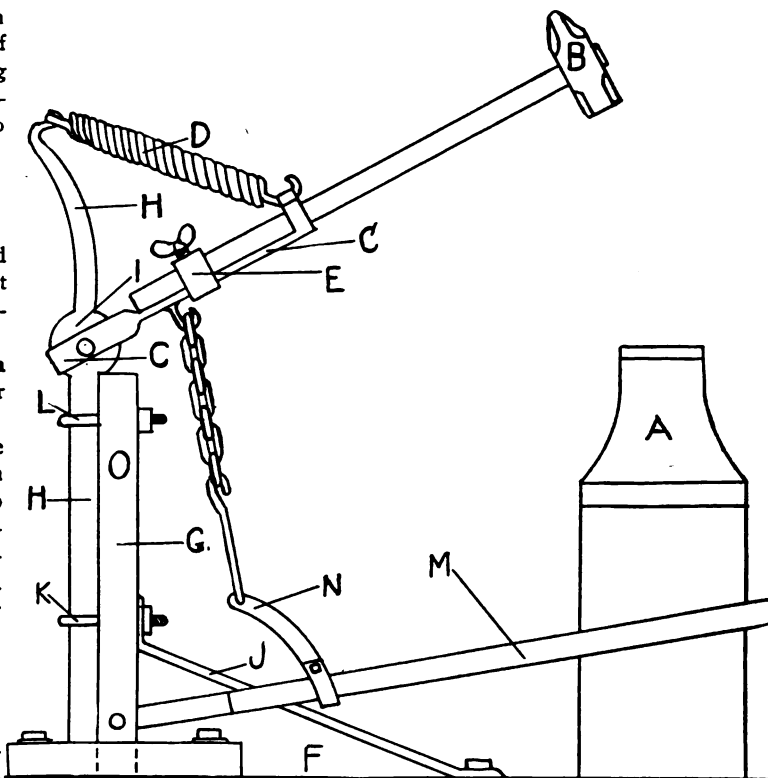

that when the nut on the front side is tightened it will grip H firmly by loosening L. The hammer can be swung to any point on the anvil, or to one side when not in use, or raised to any desired height. The foot lever, M, is offset, so as not to strike the brace at J. It is fastened to the opposite side of the post, so there will not be any side pull on the hammer. The lever, M, is a piece of 1 inch by ½ inch sledge shoe steel. N is flat iron, with end hooked around M and fastened with a bolt. C is made of a piece of 2-inch by ½-inch sock and is split and the ends welded together to receive the handle and hold the spring. The other end is split and each side given a quarter turn to fit. I let the ends go clear across, in order to keep the hammer from swinging sideways. Clamp E hooks over each side of C. A piece of leather can be put on top of handle to keep the thumbscrew from spoiling the handle. There are two braces fastened to post G at O to hold it firmly sideways. The rest will explain itself from the illustration.

The employes of the Hannibal Wagon Factory, numbering sixty-five, had a merry time on the occasion of the sixty-third birthday anniversary of A. E. Lasnier, president and manager of the Hannibal Wagon Company. To show their appreciation of the manager, they presented him with a handsome rocking chair.

ADVANCE IN RATES.

The Southwestern Tariff Bureau, through F. A. Leland, issued under date of August 3 Rate Notice No. T-4223, which is an announcement of the intention of all lines members of his bureau to materially advance the rates on vehicles (straight or mixed cars of passenger and freight vehicles), and on cars of spring vehicles and parts thereof. It is proposed, effective September 5, 1910, to establish rate of 85 cents per cwt. on vehicles (exclusive of self-propelling vehicles and children's vehicles) and parts thereof, straight or mixed carloads, subject to minimum weights in column 1 below, from St. Louis territory, to points in Texas taking Texas common point rates, including Houston and Galveston. Class A differential to be applied in making rates from points in other defined territories and to points taking higher than Texas common point rates.

It is intended also to establish a rate of \$1.94 per cwt. on vehicles, spring (exclusive of self-propelling vehicles and children's vehicles), and parts thereof, straight or mixed carloads, subject to minimum weights in column 2 shown below, from St. Louis territory to points in Texas taking Texas common point rates, including Houston and Galveston.

Third class differentials to be applied in making rates from points in other defined territories and to points taking higher than Texas common point rates.

Minimum Weights.

| Inside Measurements. | Col. 1 | Col. 2 |
|---------------------------------------------------|-------------|-------------|
| Cars 36 ft. 6 ins. and under in length | 12,000 lbs. | 10,000 lbs. |
| Cars 36 ft. 7 ins. to and including 40 ft. 6 ins. | 18,000 lbs. | 14,000 lbs. |
| Cars 40 ft. 7 ins. to and including 46 ft. 6 ins. | 20,500 lbs. | 16,000 lbs. |
| Cars 46 ft. 7 ins. to 50 ft. 6 ins. in length | 23,000 lbs. | 18,700 lbs. |

Subject to Item 84. SWL Classification Exceptions and Rules.

However, no action will be taken until a copy of the tariff is filed with the The Interstate Commerce Commission. The Interstate Commerce Commission should take cognizance of this advance, which, in their own language, is an important and general advance, and order the suspension of the tariff. Should they fail to do so on their own initiative, formal complaint will be filed with the Commission by the National Association of Agricultural Implement and Vehicle Manufacturers. The present rates are the result of a series of conferences between southwestern lines and shippers, and the understanding has been that the rates and minimums would not be changed except by conference with the shippers of vehicles.

LEATHER-COVERED SPRINGS.

A gentleman has worked out some individual ideas that he has applied to his car. The one here illustrated is a leather covering for springs to keep out damp and dust, thus preserving

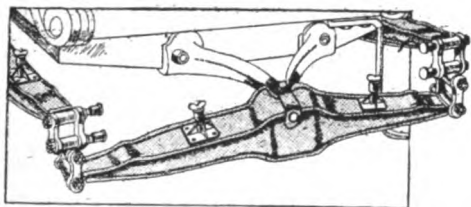

resiliency. He has also mounted the horn at the roof. There may be ideas in this worth working out by builders of motor cars.

QUALITIES OF WROUGHT IRON.

Puddled bar is the material after passing a bloom through the first series of rolls.

Merchant bar is made by cropping, piling, re-heading, welding, and rolling puddled bar.

"Single," "double," and "treble best" signifies the number of times the material is again put through these processes.

ADVANCE IN VEHICLE PRICES.

(Communicated by a Vehicle Builder.)

A few manufacturers who do not belong to the association have declared that owing to the increase in cost of material and labor that to maintain the standard of their work their costs would be much higher and with the margin of profit now so small there was no course left but to advance their prices to take care of the increased cost.

One said to us recently. "An advance is an absolute necessity. The truth is that the cost of production has been increased to an extent that makes former prices unprofitable largely because of the increased labor cost. It was explained that the demand for skilled carriage makers in the automobile field had raised the standard of wages. In some quarters there was a disposition to question this explanation, but generally it has been accepted. The statement is strictly true, according to the testimony of both carriage builders and automobile manufacturers. The latter have found it difficult to obtain the services of a sufficient number of skilled mechanics in the vehicle line without offering inducements in the way of increased wages. To retain their men the carriage builders have been compelled to raise the scale. Labor represents a large part of the cost of a vehicle and any appreciable increase in the labor cost adds heavily to the cost of production. Taken in connection with increased costs in certain lines of material the added cost is more than the builders can afford to absorb.

"Our prices will be advanced regardless of the attitude of other builders. We consider it unwise to provide for an increased cost by reducing the quality of our work and we do not believe any builder can afford to cheapen construction. The buyers of our goods are highly prosperous. They want good vehicles and are willing to pay fair prices for them.

"I have discussed the matter of prices with many dealers and nearly all acknowledge the necessity of an advance and agree with me that the buyers prefer to pay more money for first class work rather than to pay the old price for a job of inferior construction."

STAY FOR PLANE HANDLE.

A stay to support and prevent handle from breaking off a jack plane is here illustrated.

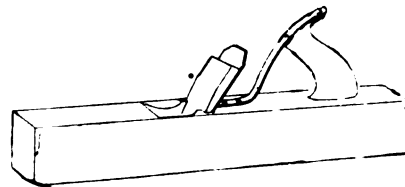

They are liable to fall, as body makers well know. It is a piece of 7/8x1/8 or 3-16 flat iron bent as shown, and screwed onto plane as shown.

END OF PENUMATIC TIRES AGAIN IN SIGHT.

The pneumatic tire again—and for about the 99,999th time—is to be "put out of business." "A former German infantry officer" is the most recent "wizard" who has performed the feat, and his invention is so wonderful that it affords a sort of rocking horse movement instead of the usual up and down motion.

"He has shifted the point of elasticity, which formerly consisted of metal spring plates under the body of the wagon, to the axles of the wheels by an ingenious angle lever system and the result is astonishing," says the German story. "The inventor uses ship's cable for hooping, but even with wooden wheels he can maintain a complete elastic course over cobblestones, country roads, etc., as the wagon jolts are no longer up and down, but move in a horizontal plane forward and backward. He can cross the pavement curb without the occupants of the automobile feeling a jolt, as the body of the wagon is not raised, as formerly, but drawn under.

A CORDIAL INVITATION.

To the Manufacturers of Carriages, Wagons, Sleighs and Motor Cars: You are very cordially invited to attend the thirty-eighth annual convention of the Carriage Builders' National Association, and to visit the exhibition of bodies, gears and materials used in the construction of your product, which will be held in the armory of the Ohio National Guard, 1410-1431 Freeman avenue, Cincinnati, Ohio, during the week commencing September 25 of this year. The exhibition extends from September 26 to 29, inclusive.

The business meetings will be held in the same building, on the mornings of September 27, 28 and 29.

The official headquarters will be at the Hotel Sinton, Fourth and Vine streets.

You will be welcome to both the exhibition and the convention, whether a member or not, as they are free to all vehicle builders. We should be pleased, however, to have you become a member of the association.

By attending the convention you will meet many representatives of the best and largest manufacturers of vehicles in the country, renew old friendships, make new acquaintances, and hear much at the meetings, which we feel sure will be beneficial to you.

At the exhibition you will find all the latest and best that the supply trade has to offer for the use of vehicle builders.

A visit to this annual reunion of your business associates will be to your advantage and we sincerely hope you will be present.

HENRY C. McLEAR, Secretary and Treasurer.

BOOM IN ENGLISH COACH TRADE.

Cooper's Vehicle Journal says: The carriage trade is experiencing a boom, brought about by the introduction of the motor, such as it has not done for very many years. It was anticipated that the motor would bring disaster and ruin upon the whole industry, instead of which the demand for coach work of every description is so great that it cannot be filled on account of shortage of men, especially in the body and trimming departments. The lack of foresight in not taking apprentices in the dull times previous to the advent of the motor as a propelling power on common roads, is now being felt in its most acute form. Orders there are in plenty at the present moment, but employers find the greatest difficulty in getting really good men to turn the work out. The bad results of not apprenticing boys to trades affects both sides, the masters are now short of men, and doubtless many of the boys, who should have been taught a trade, where they could get a good living, have gone into offices as clerks, telegraph and messenger boys, or other unskilled labor, where they will have to live on boy's wages when they are men, on account of the unskilled labor market being overstocked, instead of being able to command good wages.

AMERICAN PRODUCTS IN CAPE COLONY.

Consul Ernest A. Wakefield, of Port Elizabeth, following interviews with importers in that South African district, makes the following suggestions as to methods of increasing American trade:

In varnishes and oils, the English product in iron drums holding 2 or 3 gallons has a distinct advantage over the American article in tin. The English product costs more, but as it does not require repacking for distribution to the various customers, and as the iron drums are used by the farmer in many ways, the up-country demand is almost entirely for the English article. For reshipment in small lots the American product must be recased by the importer, which brings the cost nearly up to that of the English article. The English standard measure is invariably the imperial gallon, while the American is usually smaller and the ins are not always of uniform capacity.

EXHIBITORS RESERVING SPACE AT C. B. N. A. CONVENTION.

Ault & Wiborg Co., Cincinnati, O.
 Aden Manufacturing Co., Danville, Va.
 C. C. Bradley & Son, Syracuse, N. Y.
 Beser-Poston Tufting Machine Co., Chillicothe, O.
 Backstay Machine & Leather Co., Union City, Ind.
 W. D. Byron & Sons, Inc., Williamsport, Md.
 Buob & Scheu, Cincinnati, O.
 L. C. Chase & Co., Boston, Mass.
 Cleveland Hardware Co., Cleveland, O.
 Cately & Etting, Cortland, N. Y.
 Consolidated Rubber Tire Co., New York.
 C. Cowles & Co., New Haven, Conn.
 Cortland Carriage Goods Co., Cortland, N. Y.
 Carriage Woodstock Co., Owensboro, Ky.
 Campbell & Dann Mfg. Co., Tullahoma, Tenn.
 George R. Carter & Co., Connersville, Ind.
 Diamond Rubber Co., Akron, Ohio.
 Louis Dusenbury & Co., New York.
 Dayton Malleable Iron Co., Dayton, Ohio.
 Eberhard Manufacturing Co., Cleveland, O.
 Excelsior Seat Co., Columbus, O.
 Richard Eccles Co., Auburn, N. Y.
 Fernald Mfg. Co., North East, Pa.
 Fabrikoid Company, Newburgh, N. Y.
 Fairfield Rubber Co., Fairfield, Conn.
 Firestone Tire & Rubber Co., Akron, O.
 Federal Rubber Co., Milwaukee, Wis.
 Fitch Gear Company, Rome, N. Y.
 Gramm Motor Car Company, Bowling Green, Ohio
 Goodyear Tire & Rubber Co., Akron, O.
 The B. F. Goodrich Company, Akron.
 Hess Spring & Axle Company, Carhage, O.
 Higgin Mfg. Co., Newport, Ky.
 Hartford Rubber Works Co., Hartford, Conn.
 Herbrand Company, Fremont, O.
 Andrew Kimble, Zanesville, O.
 King Fifth Wheel Company, Philadelphia, Pa.
 Keystone Friging Co., Northumberland, Pa.
 G. H. Lounsbery & Sons, Cincinnati, O.
 Liggitt Spring & Axle Co., Pittsburg, Pa.
 Lowe Brothers Co., Dayton, O.
 Metal Stamping Co., Long Island City, New York.
 Monarch Carriage Goods Co., Cincinnati, O.
 Moller & Schumann Co., Brooklyn, N. Y.
 The Mulholland Company, Dunkirk, N. Y.
 Modoc Paint Co., Dayton, Ohio.
 National Malleable Castings Co., Cleveland, Ohio.
 National Aluminum & Bronze Co., Indianapolis, Ind.
 Novelty Tufting Machine Co., Chicago, Ill.
 F. A. Neider Co., Augusta, Ky.
 A. T. A. Nelson Co., Cincinnati, O.
 National Hardware Company, Cincinnati, O.
 Pioneer Pole & Shaft Co., Piqua, Ohio.
 Peters & Herron Dash Co., Columbus, O.
 F. O. Pierce Company, New York.
 P. Reilly & Son, Newark, N. J.
 James H. Rhodes & Co., Chicago, Ill.
 Royer Wheel Company, Cincinnati, O.
 Republic Rubber Co., Youngstown, O.
 Rose Manufacturing Co., Philadelphia, Pa.
 Thermoid Rubber Co., Trenton, N. J.
 Spitzhi Mfg. Co., Utica, N. Y.
 Edward Smith & Co., New York.
 Standard Varnish Works, Chicago, Ill.
 Stein Double Cushion Tire Co., Akron, O.
 Sheldon Axle Co., Wilkes-Barre, Pa.
 Sherwin-Williams Co., Cleveland, O.
 Sohbert Bros. Gear Co., Oneida, N. Y.
 Shortsville Wheel Co., Shortsville, N. Y.
 Victor Rubber Company, Springfield, O.
 Wayne Wheel Company, Newark, N. Y.
 West Tire Setter Co., Rochester, N. Y.
 C. A. Willey Company, Hunters Point, N. Y.
 Muncie Wheel Co., Muncie, Ind.
 Union Bow Co., Cleveland, Ohio.
 Eadie Vehicle Gear Co., New York.
 Bauer Bros. Mfg. Co., Cincinnati, Ohio.

TO SOLDER ALUMINUM.

Take an alloy composed of 6 parts aluminum, 2 parts zinc, and 4 parts of phosphor tin. Stearic acid is used as a flux, and the sluggish solder is pushed along the seam by means of an iron wire.

Carriage and Automobile Painting

PAINT BRUSHES.

In selecting a genuine bristle brush, we are told to pull out a few of the center hairs and hold them in a flame. If genuine, they will curl and act like burning hair, if otherwise, they will burn into ashes. This will not always work, for the makers of bogus bristles have it down so fine that the bristles will act in the same manner. Not long ago I saw a brush tested in this way, the bristles acting, when a blaze was applied to them, exactly like genuine bristles, says a writer in *The Decorator*, an English publication. The brush was composed largely of bogus material, and was not even represented as a genuine bristle brush. The best way is to drop a few hairs on a stove lid and notice the odor. There is nothing similar to the odor of burning hair or bristles. Feathers come the nearest, but here is still quite a difference.

It is not bogus bristles that the painter need fear so much as a poor quality of genuine bristles. Bristles and hair are like all other organic products. There are three natural grades: good, bad, and medium. It is evident that bristles and hair taken from animals which have died of disease are not so good as that cut from the living animal, or taken from the hides of animals which have been killed.

Again, the age and condition of the animal from which the hair has been taken will account for the texture of the hair. The season of the year should also make a difference. To say nothing of a few bristles that have lost their elasticity, which may be found in what is called a first class quality of bristles, and which would take up too much time to pick out one by one, there is no doubt that there is much bad hair mixed purposely, in order to meet the ever-prevailing demand for cheap brushes, to supply that part of the brush trade outside of the painting business, who demand a genuine bristle brush, but it must be cheap. The appearance of these brushes sell them. They are finished quite as well as a brush costing double the amount, but when it comes to working with them, the difference between one of them and a good bristle brush is soon manifest. The bristles having no elasticity, bunch up, and the whole brush has the appearance, when filled with paint, of being made of so many rat-tails. They will spread paint after a fashion, of course, and the people who use them, having never used any others, perhaps, think they are all right, consequently they have a large sale.

I do not understand why painters prefer white bristle brushes to grey and black, the natural color of the bristle. No bristle is of a white color in its natural state. They must be bleached in order to make them so, and it is evident they will lose some of their springiness by bleaching. Much bleaching has a tendency to rot any organic substance. For instance, take a gray hair from your head or whiskers and notice the difference in texture between it and one of the natural color. Bend the live hair and it will spring back to its original shape again; not so with the dead hair. If bent short it may break off, but in all cases it shows an inclination to stay somewhat bent.

As a gray hair is a bleached hair and dead, it is evident then to bleach hair it must part with some of its vital properties. The manufacturer, no doubt, would prefer not to bleach the bristles, but the empirical tendency of the painting trade demands white bristle brushes, and he is compelled to furnish them in order to maintain his business. Bristles may lose some of their strength and wearing qualities by the process they are required to undergo in order to keep them straight after their subsequent development into a brush, as all bristles are naturally curved. The way to tell a good bristle brush is by the strength of individual bris-

gles, and their tendency to assume their original straightness when bent quite short. It would be natural to assume that the stronger the bristles are the tougher they are and, consequently, the longer they will wear.

There is no new brush but that will leak out a few bristles, and the prevailing notion of soaking them in water to prevent this is a false one. The water only serves to swell the bristles and wood, and prevent leakage for the time being. When it shrinks, as it will surely do, it only aggravates it, making it worse. If a brush leaks its bristles so badly as to require soaking in water that it may be used, it is a waste of time and money to buy it. Work out the loose bristles while the brush is dry. If it is of good quality, it will then be ready for use without soaking.

The causes for bristles curling up are several. In some instances, it is, no doubt, the brushes, or rather, the maker's fault—the bristles not having been cured properly. In good brushes, the most prolific cause for curling is the manner in which the brush is wiped, and the way it is put away for the night. If the brush be wiped across the points of the hair, the outside hairs are bound to straggle—stand out from the rest. A brush should be wiped just to the ends of the bristles and not so that the edge of the bucket will catch the outside bristles, constantly bending them outward, until they assume a contrary position from that intended.

If you set your brush on the ends of the bristles in the oil over night, set it perfectly perpendicular and squarely on the ends. The oil will hold the brush—its specific gravity helping to support it, so that the bristles will not be liable to bend, but if set slanting, the bristles are sure to bend, and one side will bend worse than the other. When in use some of the outside bristles are apt to stand out from their fellows, and will stay that way. The way a brush is used has much to do with both its appearance and wear.

The surest way to get a good brush is to buy of a reputable dealer and pay what a good brush is worth. No matter how nice a brush looks, or how much the bristles have the appearance of being genuine, if too low a price is asked for a good brush, something is wrong. It is made either from poor bristles or is filled.

POINTS ON PENCIL POINTS.

When putting the pencil away, after the use of the day, it should be so laid aside that it is ready for use when wanted again the next day, or even a month after. To leave the color in the pencil in order to save time is a big mistake, for it wastes more time the next day cleaning it, and more still by the loss the pencil sustains in usefulness. The work cannot be done expeditiously and properly with badly-kept tools. When the pencil is done with for the night, it should be rinsed with turps or kerosene. The latter is preferable because it is oily in nature and keeps the pencil pliant. The pencil should then be rubbed between the finger and thumb with a little vaseline or lard mixed with castor oil just stiff enough to keep the hair firm. If the pencil is left with this fat, having a feathered point, its usefulness as a writer will be impaired, if it is smoothed off to a fine point it will be kept in readiness for use when wanted, but its usefulness will be enhanced if the point is pressed into a chisel shape or square.

Not all coach painters understand that writing may be done more easily and quicker with a pencil having a chisel point than one with a tapering point. When purchased writers' pencils are naturally chisel pointed. It should be the aim to preserve that

point just as if the writer were a lining pencil. The chisel point gives a broad, even line, when outlining letters, which renders the work of filling in much easier. Every unnecessary stroke of a pencil means so much wasted time, which tells against neatness and speed. It may be thought that a tapering point is best for getting into corners of letters, but it is not so. Take the letter I, for instance. First, two downward strokes with the flat side of the pencil forms the upright sides, then with the point of the pencil used edgewise one may finish the top and bottom outline. A couple of strokes with the flat side of the pencil will fill in the body of the letters. With a tapering pencil work could not be done so speedily, nor would the corners be so sharp and true.

PAINT SHOP TRESTLE.

The one illustrated will be found a useful pattern of body trestle for paint shops; for, not only can the body be turned round while trestle is stationary, says the Australasian Coachbuilder, but the whole may be shifted to any part of the shop. The framework is about 2 feet 9 inches square, and is made of four pieces of Oregon pine about 6 inches deep and 2 inches thickness, and with 1 inch flooring boards nailed on top. This rests on what may be described as four extended castors, consisting of iron stays, A, at each corner made from $1\frac{1}{4}$ inch to $\frac{3}{8}$ inch tire iron, through which are loosely fitted forked irons or carriers for the

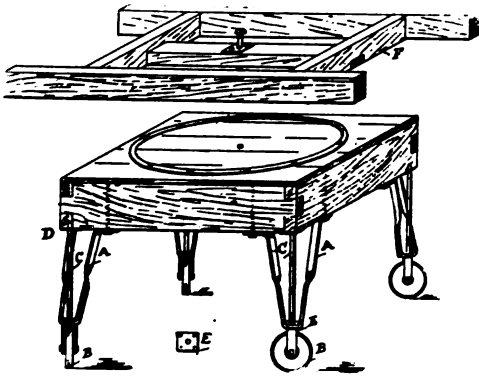

cast iron wheels, which rest on the floor. The wheels, B, are 5 inches or 6 inches diameted by 1 inch thickness, and the forks, C, are rounded down to $\frac{5}{8}$ -inch, and fitted so that they will turn freely when in use. They are made long enough to go about half an inch through the plate, D, which is screwed underneath each corner of the frame. The weight is carried on the shoulder, E. On the top there is a circle made of $\frac{3}{4}$ inch half-round iron, on which rests the frame that supports the body, F, which is made from 4 inch by 2 inch hardwood. This has iron plates screwed underneath, where it rests on circle plate and is bolted to the frame through the middle bar, so that it can be turned round freely.

VENTILATING VARNISH ROOM.

A writer in Australasian Coachbuilder says: Ventilation is a necessary item, and is not expensive by any means. This may be installed in either of two ways. The ordinary grating at the top of the wall may be depended on for the paint shop, but this should be covered with fine gauze. For the varnish room, a better one is constructed as follows: Make a pipe from ordinary black iron, forming the bottom bell-shaped, something similar to a phonograph horn, with the wide portion at the bottom. Pass this through the center of the roof, and on the outside fit a revolving cap to come well down over the pipe, allowing sufficient room between the pipe and cap for a current of air to pass between them. If a gauze cap is fitted on the bottom this should make it dustproof. A close-fitting lid should be hinged on the bottom, as in stormy weather it may be necessary to effectually close this vent altogether.

PLENTY OF TURPENTINE AND ROSIN.

Consul Thomas E. Heenan, of Warsaw, in his annual report, states that, although turpentine and rosin are imported in ship-loads by Hamburg commission houses and placed on the Warsaw market, direct business could be done quite as well with local firms, who would gladly enter into negotiations with exporters. As to the rosin industry in Poland the consul writes

Plans for the industry are nearing realization. At the first meeting of the organization committee, in which interested merchants took part, it was decided to form a company, and applications for shares were received. Although the number of persons taking part in the meeting was small, about one-third of the required capital was subscribed; the remainder will easily be secured. Three committees were chosen, one to contract for forests necessary for the trial distillery, another for working out the articles of association, and a third for certifying the estimates and calculations. The forest expert, recommended by the Polish Forest Bureau, started at once on an inspection of the forests.

The first turpentine and rosin distillery was opened in May, 1910, near Koluski, on the Warsaw-Vienna Railway, where most of the private forests are situated. If private forests are found insufficient, recourse will be had to government forests. It turns out that the production of local turpentine-bearing trees is much better than anticipated, and there are strong hopes that the industry will develop accordingly.

METHOD OF MAKING BLUE-LINE PRINTS.

All the material necessary is a sheet of some ordinary grade of carbon paper, a No. 6 or 8 drafting pencil having a blunt, smooth point, a blank sheet of common typewriter paper, and a smooth, hard drafting board or table.

After the desired form or sketch has been carefully laid out and all the lettering nished lightly in pencil on the blank sheet, place the carbon paper with the carbon side upon the table. Then lay the blank paper (with the sketch side up), on top of the carbon and after fastening both to the table with thumb-tacks, proceed to trace the sketch with the hard pencil, being careful to press quite hard and uniformly as the lines of the sketch are followed.

By examining the carbon it will be found that wherever lines have been drawn, no matter how small a letter or figure was made, a good impression was reproduced on the face of the carbon. The latter may then be used the same as a tracing to print through. It should be exposed from two to three minutes, according to the speed of the paper used, and after the latter has been washed out thoroughly, the desired result will be accomplished.

Carbons prepared in this manner, which I have been using for some time, says a writer in Machinery, appear to be as good as when made. In order to save time in printing, several carbons can be made from the original sketch or by tracing over prints. By placing these in a large printing frame, a number of blanks can be printed simultaneously on one large sheet. By filing these carbons in indexed envelopes or between indexed sheets, they will last almost indefinitely and will be convenient to get when needed.

EXHAUST-PIPE VARNISH.

The trouble about keeping the motor car exhaust pipe in a well painted state might be helped by using the smokestack paint—asphaltum varnish—that varnish makers sell for use on railway locomotive engines. This preparation has to stand quite as much heat as an exhaust pipe, and it seems to keep the stack looking nice and bright. When a car is new the maker could feel sure that a coat of some such preparation would keep up appearances for quite a time.

THE GRAPHIC CHART IN COST SYSTEMS.

The graphic chart as an adjunct of the cost system is employed with most useful effect in some industrial works. It tells quickly and intelligently the story of business in its various phases. No better means of deduction has been devised, not only by comparison of present with past conditions, but in the relations of the several factors which are essential in understanding the market and conditions within the works themselves. In one plant, which includes machine shop and foundry, the system is made up of several charts, with curves plotted monthly, from a beginning in 1902. For example, one chart shows gross sales in red ink, accounts payable in green, accounts receivable in purple and cash in black. Essentially important information is obtainable at a glance from the relations of these curves one to another. If the ratio between the volume of business and accounts receivable is getting high, the question may be asked if customers are going ahead too fast and are buying in a speculative way. If, on the other hand, the ratio is seen to be getting low, the indication may be that general business is contracting and people are liquidating, in their doubt as to the immediate future. The ratio between cash and bills receivable is another source of valuable deduction, showing perhaps, that the company is paying its bills faster than customers are making remittance, or that it is buying too much and expanding too rapidly, or that too cautious a policy is being pursued. The combination of curves of sales and labor costs and overhead expense frequently gives information which the management can employ to good effect. And so such a system may be carried through the cost records, as owners may apply its usefulness.

Charts are so accessible that they are consulted much more constantly than other forms of record, which would give similar comparisons. They serve to make a manager watchful. They act as an automatic check on his judgment. A valuable feature of the chart is that it shows relative conditions without revealing actual figures to foremen and others to whom it is not advisable to tell just how the business stands, but in whom an interest is created by the system. While at first glance the chart may appear complicated and even cumbersome, to those who use it the lines are as clear in their meaning as type. Its maintenance requires little labor.—Iron Age.

DENY IT.

The officials of the Goodrich Rubber Company, Akron, Ohio, deny the report that the company has purchased land near Ashland on which it intended to erect a branch factory for the manufacture of automobile tires. They say that the company owns enough land near its plant in Akron for all the buildings that will be erected for some time.

BIG FIGURES.

Omaha's implement and vehicle business will amount this year to \$14,000,000, probably a little more. An accurate investigation made early in January showed that the total for 1909 was a little more than \$12,000,000, and there is assurance that the increase this year is between 12 and 15 per cent.

SPOKE MANUFACTURERS MEET.

The Spoke Manufacturers Association of the Mississippi Valley held the second of their three meetings a year recently at the Southern Hotel, St. Louis, the discussion for the most part being in regard to the scarcity of the supply of timber for the manufacture of high grade products. Like all manufacturers of hardwood products, especially those using hickory and walnut, they fear unless conservation is practiced, the supply of the better grade of timber will soon be depleted beyond the power of those working for conservation to restore.

THE COMPOUND HUB—A NEW THING.

In the manufacture of wagons, no piece or part is required to be so free from flaws and defects as the hub. The old saying that "a wagon is good as long as the hubs are good" is quite true and logical enough, for when the hubs fail, the wheels are short lived.

The bane of the wagon manufacturers, so far as the hubs are concerned, is their inclination to check. Notwithstanding the fact that care is used in proper seasoning, that pains are taken to thoroughly oil and paint, and to firmly set the box and hub bands, yet after every apparent precaution, trouble is likely to occur when the hub is subjected to hot climates. When a check does occur large enough to admit moisture, the deterioration of the hub is well under way.

The process of manufacturing hubs is as old as the history of wagons and carts; the only advancement having been made in the advent of modern hub manufacturing machinery. The very best young oak trees measuring from ten to twenty inches in diameter, covering thousands of acres of our forests and representing many million feet of lumber, are annually sacrificed for the manufacture of wagon hubs alone, to say nothing of smaller trees used for hubs for lighter vehicles.

A newly organized Compound Wood Company makes the rather surprising announcement that careful estimates, demonstrations and experience warrant the statement that hubs of a superior quality can be made from the sound parts of the lower grades of oak lumber fully as economically as the present manner of manufacturing, thereby effectively conserving the forests by removing the demand for these trees for this purpose and at the same time utilizing the by-products of the sawmill.

The manner or process by which the company proposes to accomplish the result is by the use of a vegetable adhesive compound (or cement) which when applied to pieces of wood of any size or thickness and subjected to a powerful hydraulic pressure, welds these various pieces into one, which, unaffected by moisture or heat, may be subjected to all weather conditions with perfect safety.

This compound is not new, but has been thoroughly tested and articles so constructed and cemented have been in actual use and subjected to trying climatic conditions for years. The company will guarantee that its hubs will not be affected by weather conditions.

Between the knots and other defects of the lower grades of oak (No. 2 and No. 3 common), hub pieces may be sawed with a limited loss or wastage, as they only require a piece $3\frac{1}{2} \times 12$ inches to form the wall of the hub, as the hole for the hub box is not built in. Worm holes and like defects are not objectionable, as they in no wise weaken or reduce the quality of the hub.

These pieces or segments are cemented together, forming a block of the same shape as a rough hub block cut from a tree. The block so formed is then turned, reamed, cupped and mortised in exactly the same manner as all hubs are now made. The result is a perfectly dry and perfectly true hub, differing materially from the hubs turned from the tree, as they never season round and true. The heart of a tree is not necessarily in its center and when the heart is bored out and the hub turned, there is likely to be considerably more sap on one side of the hub and this dries very differently from the denser part, with the result that the hub is sometimes one-half inch out of true. Both end and spoke bands must vary in size and are purposely made in different sizes in order that they may be adjusted to the various unequal sizes of hubs. It is not uncommon to see in any of the larger wagon factories to-day a half-dozen hubs set on end and a man going from one to the other adjusting bands nearest to a fit before the hub goes into the hydraulic band setting machine.

But this is not all the trouble an imperfect hub causes. When you come to re-mortise, it is often found that the hub is dried so out of shape that its ends are not square and when measuring from the end of the hub to the mortising chisel, more trou-

ble is encountered and time and money wasted. Often hubs with quite large checks are used, especially if the check is of such a nature as to be drawn together or partially closed up by the bands in the hydraulic press. The check or opening is then filled with putty, as it passes through the paint shop; another process involving time and expense.

A hub turned green, especially one having considerable sap, has a rough surface, in which case the turning knives cut easily, but do not cut smoothly, therefore, after they are dry and before using, it is necessary to put the hubs into a quick acting lathe and with wood rasps and sand paper, smooth them down—another operation and another expense.

With the compound hub, all of this trouble and expense is avoided and checking is out of the question. To illustrate; segments for a hub can be made from any thickness of lumber. One inch oak can be used and in that case, a standard hub for a 3¼ wagon would require some twenty-eight pieces, each piece presenting a one-inch face on the outside of the hub. Admitting for a moment the possibility of a check, it could only be one that would open on the edge of an inch piece and would be so slight as not to break open the paint and varnish. If the piece as inclined to check, it could not be aided by the adjoining pieces, for these same adjoining pieces would counteract the checking, as the grain would not be the same.

Hubs made from trees are finished green and shipped green. The wagon manufacturers store them in sheds for at least two years, when they are taken out and put into the dry kilns. A certain per cent have by this time developed checks and other defects and these go into the wood pile. The dry kiln develops still another percentage of defects and the spoke hammer still another, so that the total is considerable; estimated by different manufacturers from ten to twenty per cent, according to the quality of the hubs.

There is no salvage on a defective hub, except its sale for use for fuel. They are all paid for when delivered. To the original price of the hubs must be added the loss by defects and at least two years' interest on the money invested; not forgetting that the hub that goes into the wood pile draws the same rate of interest as the one that goes into the wagon. In addition to this expense, there are the yardage, taxes, insurance and risk, all of which must be added to the original cost.

There is no doubt but that there would be a substantial saving in the cost of a compound hub over the cost of other hubs when ready for use.

A summing up of the proposition is a saving in price, storage room, interest, taxes, insurance, dry kiln expense, loss by defects, mortising expense, fitting hub bands, sand papering, puttying, checking and breaking down under the hammer.

The company mentioned has perfected the necessary special machinery for the manufacture of these hubs and are fully protected both in design and construction, and also in the use of cement, which is a vital feature, and have made application for patents covering their process of manufacture and special machinery.

Hubs made by this process have been subjected to the most exhaustive tests and the results have proven conclusively that they are superior to the old style hub.

TO CUT BRASS.

With a quill pen dipped in a strong alcoholic solution of corrosive sublimate draw a line on brass, let dry, and then go over the line with the pen dipped in nitric acid, when the metal may be broken like glass cut with a diamond.—Shop Notes.

COMMERCIAL EDUCATION.

An institution in St. Louis known as Barnes University has opened a department of salesmanship and commercial science, the course extending from October to May. A booklet going into the subject in detail is to be had by any one interested.

NEW WAPAKONETA WHEEL COMPANY.

The New Wapakoneta Wheel Co., Wapakoneta, Ohio, is progressing rapidly with its new plant. This concern has recently taken over the old Wapakoneta Wheel Co., through conditions caused by a change in management, but virtually controlled by the same interests as before, the change in name becoming a necessity through the expiration of the corporate life of the old concern's charter.

The new company will soon have the most complete wheel factory in the United States, it is claimed, and from a perusal of their plans as outlined and now rapidly being consummated one can not but admire the pluck of this institution, in its confidence in the stability of the vehicle trade. It will confine its efforts solely to vehicle and wagon wheels, the same popular line as produced under the old management. With a fully paid in capital stock of \$75,000 they will receive their share of the wheel business.

Mr. Ed. Trau, the general manager, is also the genial manager, and will make lots of friends in the trade, as he comes in contact with the buyers. He knows the wheel trade thoroughly, having grown up in the business from boyhood, and the stockholders of the firm have implicit confidence in his ability to make good.

We would ask the trade to glance at the handsome cut of the Wapakoneta wheel factory shown in their ad, and urge a trial order. Only the latest machinery is installed in this plant of 320x132 feet.

The officers of the company are: Edwin Abe, president; C. T. Kolter, vice-president; Ed. Trau, general manager; John Tausch, secretary; L. N. Blume, treasurer.

REMARKABLE DEVELOPMENT OF A GOOD ARTICLE.

We present an illustration that is a story without words in itself. It is the picture of a carload shipment of axle bearings of the roller type, sent from the Timken Roller Bearing Co. plant in Canton to the Timken-Detroit Axle Co., of Detroit.

The application of the roller bearing to reduce friction, though recognized for a long time in the vehicle trade as an important invention, met its overwhelming response from the motor car

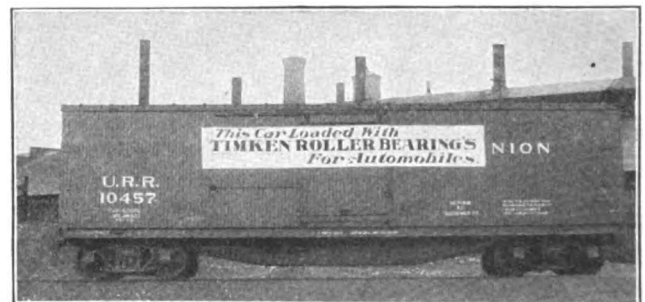

makers, especially as the mechanical engineers of the Timken staff were so happy in their design of the Timken automobile axle. But no one field confines the use of these bearings. They are now generally accepted as hardy, long-wearing, strain-resisting, friction overcoming devices that have answered every practical question asked of them, and as a result two big plants are kept busy producing the axles and bearings that conquer by the sign of "Timken."

A "WINE" PEDDLER NOW.

Henry Farman, whose name has been so dramatically identified with flying machines, has cut out the whole business to accept a position as a peddler of champagne. These wine-making corporations pay great salaries, and have the advertising instinct keen within them. But it seems a peculiar change of means of earning a living.

THEY ARE AFTER THE MAGNETO.

It seems that the faults of the magneto are being found out, if what we see in English journals is indicative. The following is a communication in Motor:

To what extent does the magneto owe its present vogue? To two factors: (1) Extra power obtained owing to superior timing of plain make-and-break contacts and distributor; (2) suppression of the accumulator and attendant recharging of same.

The extra power obtained in many instances on fitting a magneto is due to the superior timing of the make and break system over the old trembler coil, and not due, as many seem to suppose, to some occult power contained in the magneto itself. If a plain make-and-break distributor and coil ignition with battery be fitted, exactly the same power is obtained as with a magneto, but, as we claim, with an infinite superiority in flexibility of advance and retard, ease of starting, and slow running. It is significant that the leading London motorbus companies having survived their attack of "magnetitis," are now fitting nothing but coil ignition as the only one commercially possible, one, at the same time, strong and simple.

There remains, then, the battery question. This has been solved by the introduction of charging and lighting outfits, which not only light the car, but charge the ignition battery. These lighting sets are making rapid strides in popular favor, and will, in the course of a year or so displace the acetylene and oil systems from all but the cheapest of small cars. The up-to-date lamp makers realize this, and are taking steps to meet the rising demand. Given a fully charged battery, the need for a magneto is no longer felt, for the ignition may be operated either by a distributor coil or by a low-tension coil with make-and-break tappets or plugs in the cylinders, the former system being preferable. It is a question of survival of the fittest, the magneto and the oil lamp or the coil with the battery charging and ignition set.

NEW YORK LIABILITY LAWS.

There is now in operation (Sept. 1) a New York State law affecting the liability of employers that is most important in its action. We append a brief comment by E. S. Lott, an expert. He says:

"These amendments to our labor laws are, in their entirety, the most advanced ever enacted in this country, although, except as respects the compensation payable, not as far-reaching as the labor laws of many foreign countries. I speak of the two so-called Wainwright-Phillips acts as a whole because the two laws are so interwoven that they should be studied together. One of these acts is generally known as an act amending the employers' liability law, with alternative compensation plan, and the other as the compulsory workmen's compensation law, relating to certain dangerous employments.

"This is the beginning of a great change, and it surely is but the beginning, unless the new doctrine is declared unconstitutional. In place of 'damages' to be fixed by a court and jury, and hinging on whether or not the negligence of the employer was responsible for the injury, beginning September 1 the employer engaged in certain 'especially dangerous' occupations must 'compensate' his injured workman, no matter, one can almost say, who is at fault. The new law as it now stands reads:

"This article shall apply only to workmen engaged in manual or mechanical labor in the following employments, each of which is hereby determined to be especially dangerous, in which from the nature, conditions or means of the prosecution of the work therein, extraordinary risks of the life and limb of workmen engaged therein are inherent, necessary or substantially unavoidable, and as to each of which employments it is deemed necessary to establish a new system of compensation for accidents to workmen."

"It will be seen that September 1 brings with it the doing away, to all intents and purposes, with several important de-

fences which the law has always accorded employers when sued by an employe for damages arising from an accident. Hitherto if the accident was caused by a fellow servant (by another employe of the employer) the employer was not liable. The new laws says that if the accident is caused by any employe intrusted with any superintendence, or by any employe intrusted with any authority to direct, control or command any employe, then the employer is liable to the injured employe for such damages as a court and jury may decide. Formerly the injured employe had to prove that he was not at fault—that he was free from contributory negligence. On and after September 1 the employer must plead and prove that the injured employe was negligent, else he cannot use that as a defense. Until the new law was passed, it was always held that when a person sought and secured employment he assumed within reasonable bounds the natural dangers to personal injury which went with his employment. Many employers will feel that the changed conditions which come with the new law impose a hardship upon them.

"However, the trend of the times is toward the doctrine of 'compensation' as distinguished from 'damages' for the injured workman and truly the new laws are but the first faults in this country of a doctrine which has secured a firm footing in many countries and which is growing apace here, several states having commissions actively engaged in drafting bills to be presented to their legislatures.

"The result is that on and after September 1 a workman who sustains an accidental disabling bodily injury while at work in this state in certain employments will be entitled to accept the 'compensation' fixed by the Compulsory Workmen's Compensation Law for such injury, or he may disregard the new law and bring suit under the law as it existed before the enactment of the new law. He may choose the old law or the new law."

WAGONS IN AUSTRALIA.

According to a report by Consular Agent Frank R. Perrot: nearly all the wagons used in Perth and Fremantle are of the "table-top" type, the bed being supported by springs and extending over the back and front wheels. They have a capacity of 2½ to 3 tons for what is known as a double lorry—that is, a wagon drawn by two horses—while the single lorry drawn by one horse, has a capacity of 2 tons.

The delivery vehicles of the retail stores are of the two-wheel type, and the four-wheel light vehicles, similar to American express wagons, are of such style as would use American platform gear and "clip work." Some of this gear already comes from the United States. Practically all the wagons used in Western Australia are made in the state of timber imported from the United States in the white, and a large business is done in American material.

COMPLETED A FACTORY.

The recently organized Schurmeier Motor Car Company, of St. Paul, recorded a deed whereby the company purchased the tract having frontages of 660 feet on University street and 596 feet on Griggs street. The consideration was \$15,000. Here the company has just completed a \$12,000 factory building, a one-story brick structure, extending 50x150 feet.

25 PER CENT INCREASE.

An increase of from 20 to 25 per cent in business is noted in the annual report of the Mandt Wagon Co., for the year ending July 1. The report was made to the Moline (Ill.) Plow Co., of which the Stoughton plant is a branch. The company in the past year has erected a new powerhouse, foundry and a wing of a new blacksmith shop and steel storage adjoining is in progress. New lumber sheds and a storage house have been erected within the past year.

OILING ROADWAYS.

Not only to lay dust, but to harden surface, there is much use of oil and compounds of many kinds to secure results. Vehicle owners have not been enthusiastic over some of the experiments, but there is more and more thought being given to the problem with good results. The street commissioner of Newton, Mass., has much to say on the subject that will interest:

This gentleman says that "no matter how well a road may be suited to the conditions for which it is intended, if it be poorly constructed or poorly maintained its deterioration will be rapid. The severe impact to which the surface of the road is subjected by the action of horses' feet tends to loosen the exposed stones and break through the binding surface; the fine material thus loosened is more readily carried off by wind and water, and water can better penetrate through to the foundation. The surface irregularities produced in this way are continually increased by the pounding action of the wheels. Added to this, experience has taught us that the automobile has become a method of transportation which cannot be dispensed with at the present time.

"For these reasons it has become necessary to put on the surface of our roads a bituminous binding material which has not heretofore been considered necessary. Experience has taught many of the best road builders at the present time to seek for something in the way of a binding material which will not be too expensive, and which will prevent the road from being dusty, and the surface from being torn up by the wheels of automobiles.

"It is impossible to find a single material and method of road or street construction and maintenance which will suit all conditions. Materials and methods which are perfectly adapted to a road in one locality may be entirely unsuited to a road in another. The reason for this is obvious. The traffic may be entirely different in kind, and the local physical conditions may vary in a host of important particulars. The better way by which to select methods and materials is that obtained by experience and the average constructor of roads must rely to a very great extent on the experience of others.

"A section of Washington street in Newton, where there is a combined traffic of horse drawn vehicles and automobiles, which is about evenly divided, was covered with a coating of asphalt-oilene which contains about 65 per cent. asphalt. The asphalt-oilene came to us in a tank car. The car was connected with a small steam boiler and was heated to a temperature of about 100 degrees F. This allowed the material to flow through the hose after the car had been placed on a trestle about ten feet above the level of the ground. This material was then put into a tank which had just been built by the Studebaker people of New York. It is a steel tank, holding about 550 gallons. It contains forty two-inch perpendicular tubes which pass through the tank. Underneath this tank there are two large burners supplied with herosene oil, which is forced in by pressure. This heats the oil to the desired temperature and a thick heavy asphalt oil can be melted and applied in this manner. There is a fire box that extends the whole length of the tank which gives an even heat. The oil is applied through a sprayer or a spreader which is perforated and the oil trickles down onto the surface of the road in very fine streams and covers the road thoroughly by going over it once. In my opinion, this is a very desirable way of putting on any heavy asphalt oil, as the material can be readily heated and applied in large or small quantities by valves which regulate the flow. We found this wagon very useful in our work last year and it is something which is entirely new in this part of the State, and I believe will be one of the most useful articles for its purpose.

"After the oil was applied, the road was covered with a light coating of sand which dried out very readily and we were able to use the road within a very few hours after the application of the sand.

"In applying the oil, it is better to take one-half of the road at a time, leaving the other half open for traffic. This saves driv-

ing on to the oil by the teams spreading the sand and also the liability of teams getting spattered with the fresh oil."

The area covered was 19,194 sq. yards. The cost per square yard was 3 2-3 cents.

NEW AUTO TRUCK WHEEL.

A truck wheel which is light in construction, slightly in appearance, and which permits of the mechanical driving and steering of both front and rear wheels, has been perfected by John McGeorge, of the Cleveland Engineering Company. This remarkable mechanical device, says the Chicago Record-Herald, is the culmination of twelve years of thought and study on the part of the inventor over the principles involved in the design of the wheel. These principles have now assumed concrete form and have been made the basis for broad fundamental patents recently issued in the United States and in all the principal countries of Europe.

Most motor vehicles are driven through the rear wheels and steered by means of the front ones, though the advantages of a front wheel drive have long been recognized, as every one knows it is easier to pull a wagon than to push it. But the difficulties have been practically insurmountable until Mr. McGeorge solved the problem and gave to the world a wheel which can be both driven and steered.

Wheels of this sort have been attempted (for truck builders have long recognized their value) and have met with more or less indifferent success, but the majority of them have been either too clumsy for use or too light for the work required of them. The McGeorge wheel resembles an ordinary wheel in appearance, and yet is designed to withstand the severest shocks encountered on the roughest roadways.

HOW TO PREVENT BRONZE BEARINGS FROM RUNNING HOT.

Flow a mixture of washing powder and water through the oil cups while they are opened as wide as possible, and the machine running light without any load. The fluid as it comes through the bearing will be very black. Run about one quart of this mixture through and then follow with clear water to wash the bearing out clean. This will make the axle and bronze boxes smooth and eliminate the possibility of new bearings running hot.

A REAL HERCULES.

The Hercules Buggy Company, the largest factory in Evansville, Ind., has more business than its present plant can handle and is contemplating a large addition. The company is doing an enormous business and the sales for the twelve months past have run 25 per cent ahead of any previous year. The company on July 15 paid a quarterly dividend of 1¼ per cent on preferred stock.

THE WHOLE LOT.

The Griffin Hardware Company, Eugene, Oregon, has taken over the entire stock of wagons and hacks of the Mitchell make which were held by D. B. Labbe & Sons. By this method of disposing of the stock the creditors will receive the full amount of their claims, and there will be something left.

REAL OBLIGING GOVERNMENT.

M. Jones, manager of the Reuter Hub and Spoke Company's plant, at Batesville, Ark., has arranged with the government to have the channel of Polk Bayou enlarged to the company's hub factory, to enable employes to reach the factory with gasoline boats.

MOTOR CARS IN JAMAICA.

Those of American Make are in the Highest Favor on the Island.

Consul Frederick Van Dyne of Kingston submits the following report on the motor car trade in Jamaica:

Until the beginning of the recent tourist season there were not more than half a dozen motor cars owned in the island, but with the advent last winter of the Jamaica Motor Company—organized and managed by Americans, although there is some Jamaican capital invested in it—there has been a marked increase in the use of automobiles, and there are now over twenty-five owned here, besides those belonging to the company. This company has at present fifteen cars in service—ten five-passenger, one four-passenger, three twelve-passenger and mail cars, and one large truck for hauling freight.

Besides arranging several attractive tours around the island the company maintains a regular daily service, carrying passengers and mail between Kingston and Port Antonio. It has the contract for carrying the mails, and runs Pullman motor mail coaches, having seating capacity for twelve passengers, with separate compartments for mail and baggage. With a sixty horsepower truck specially fitted for the purpose it carries freight in parts of the island not reached by the railroad. The rates charged by the company for carrying passengers over the regular route in the mail and passenger car are 3d (6 cents) per mile; per day for car \$20; per day, \$4.50. The company has a well appointed garage where repairs are made and machines, supplies and accessories are sold. It handles only an American motor. The manager states that the volume of business has exceeded expectations. Another American motor car firm has a local agency in this city. Motor delivery vans are used by a local bakery establishment.

There are over 2,000 miles of excellent roads in the island, which are constantly kept in repair by the colonial government.

The unusual combination of mountain, ocean and tropical scenery afforded here makes Jamaica a particularly attractive field for motorists. As the country is mountainous and the traffic at times heavy, motors specially constructed for climbing are required. The climate causes exposed metal parts to tarnish quickly, and leather discolors readily. Any improvements designed to obviate these difficulties would prove popular. The number of sales of high-priced cars is not likely to be great. The general demand is for a strong, well-made car of moderate price, not to exceed \$1,000 to \$2,000.

DEAD-AXLE CARTS STILL IN USE IN SPAIN.

Consul Robert Frazer, Jr., furnishes the following concerning the class of carts and wagons in general use in southern Spain:

The class of supplies such as are manufactured in the United States—wagon gears, axles, wheels, platforms, and springs—is held in stock here by a few whole sale iron, steel, and heavy hardware dealers, from whom wagon and cart builders draw their supplies, a list of which is transmitted and filed in the Bureau of Manufactures. Spring trucks, drays and delivery vans are occasionally seen inside the city, but the habits of the people and the condition of the roads of the region militate against their general use for transportation purposes. The fruit, wine, rice, and other agricultural products transported by road to this port and to cities in the interior are conveyed in dead-axle carts and wagons, the building of which constitutes a very important Valencia industry. The typical freight cart of the district is a strong two-wheeled vehicle of 2 to 5 tons capacity, drawn by 2 to 6 horses or mules. The body of the cart is constructed of alternate upright rods of steel and oak and the rims of the wheels have an outward cast of 4 to 6 inches. With the exception of the axles and steel supplies, these carts are all made by hand in small factories, of which there are three or four in every village, the workmen earning the equivalent of about 48 cents per day.

MULTUM IN PARVO.

A body has been patented in England which can be put to a combination of uses. It consists of a fixed driving seat of normal pattern, with boot sides curving down sharply behind the seat to the usual thickness of runner. On this runner may be attached any distance between the driving seat and end of chassis a box seat hinged on the back edge, with seat rails and folding back rest, so that a four-seated car with a varying amount of leg room is obtained. The heel board of this hind seat is double, and can be removed to form a continuation of the boot side below the front seat, so that with seat board and irons hinged over the back, the whole forms a small van body. The inventor also proposes using the body as a jaunting car by removing the two back rests from the driving seat, and fixing up the long single back rest of the hind seat along the central axis of the car, the occupants of these seats being accommodated at floor level, and the individual back rests of the front seat being utilized at an angle and resting at the level of the hind seat board, which in this case with its seat rail, is used as a luggage grid.

PLAY AND WORK.

The B. F. Goodrich Co., of Akron, Ohio, has kept up the custom through years of illustrating, by means of hangers, of humorously depicting just how its busyman spends his vacation. The cartoons are always ingeniously thought and worked out, and are actually interesting. This year the hanger gets into new fields of fancy. The motor car is ornamented with wings, so it is a land-and-air vehicle. The vacation man is perched away up on a comfortable cliff. The busy haunts of men are seen away down in the valley, the busy haunt being the rubber factory, he fishes for flying fish, guns for flying birds, draws wisdom for new business ideas from flying owls, and takes his solid sustenance from trees whose fruit is pretzels. How can that be surpassed for comfort?

CUTTING A MELON.

At the annual meeting of the stockholders of the Chalmers Motor Company a cash dividend of 30 per cent and a stock dividend of 1,000 per cent on the capital stock of the company were declared. The 1,000 per cent stock dividend means the increasing of the capital stock of the company from \$300,000 to \$3,000,000. This entire stock dividend was divided pro rata to all the stockholders, the par value of the shares being raised from \$10 to \$100 each. Within the last 18 months the Chalmers plant has been tripled in size and the new capitalization more nearly represents its value.

TO BE ABSORBED.

Negotiations for the consolidation of the Morgan Truck Company, builders of automobile trucks, in Worcester, Mass., with the Bradley Car Company, the Worcester division of the Pressed Steel Car Company, are under way. The books of the Morgan Truck Company are being examined by the auditors to determine the value of the business.

THIRTY A DAY.

The Fort Smith (Ark.) Wagon Factory is enjoying the heaviest business in the history of the plant, according to statements given out by officials. More men than ever are being employed and the daily output is approximated at thirty wagons. Fully 300 men are employed.

"SUBURBAN LIMITED."

The "Suburban Limited," a small 10 to 20 horsepower car, is another new car that will be manufactured in Detroit by the De Schaum Motor Car Co.

AN IMPROVED TRIO OF CARRIAGE SHOP MACHINES.

The well known manufacturers of carriage wood-working machinery, the Bentel & Margedant Co., of Hamilton, Ohio, whose list of improved machines appears in their advertisement opposite the title page in this issue of *The Hub*, are offering the carriage trade three improved machines herewith illustrated such as have been introduced in many of the leading factories throughout the country, affording results that have been considered indispensable.

The Hamilton Improved Wheel Hub Boring and Boxing Ma-

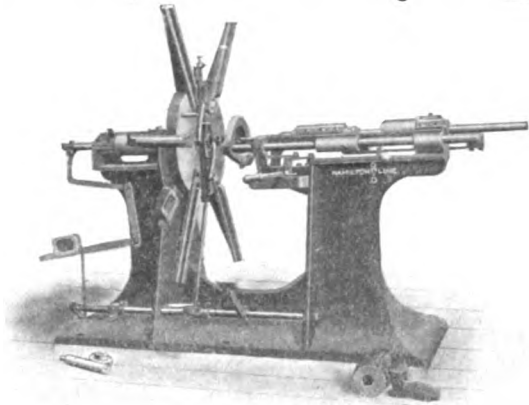

Hamilton Carriage Wheel Borer and Boxer No. 185.

chine, No. 185, is the first of these, being especially designed for boring out carriage, buggy and light wagon wheels for the iron box, and in the use of the Hamilton inserted bit cutter used for this machine, it is adapted for various sizes of boxes, the adjustments being easily made.

The Hamilton Hydrostatic Wheel Box Press, No. 287, is a companion machine for the above, designed for driving carriage



Hamilton Wheel Box Press No. 287.

wheel box quickly and accurately, and with little attention from the operator, all movements being automatic, and the arrangement of the hydrostatic pressure, through safety relief valves,

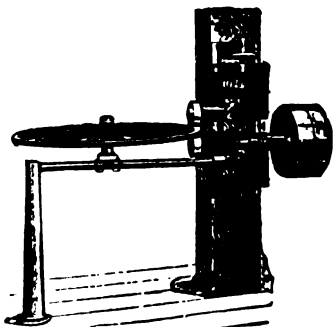

Hamilton Tire Truer No. 314.

being such that there can be no splitting of the hubs through overpressure.

The Hamilton Wheel Tire Truing Machine No. 314 is the last of this valuable trio, same being designed to true up and straighten the tires on the wheels with great saving in time and labor,

the work being accurately done, as the tire is pressed on the wheel sideways, so as to overlap the rim evenly on each side, through the medium of the hardened steel adjustable rolls provided, same working equally well on channel and on straight tires.

The new Hamilton Catalogue L will give further details regarding these and other machines of the improved Hamilton-Ohio-Line such as listed in advertisement in this issue, and same will be cheerfully forwarded to manufacturers on application. Address the Bentel & Margedant Co., Hamilton, Ohio.

DEATH OF BENJAMIN W. WILSON.

B. W. Wilson, father of Daniel T. Wilson (Flandrau & Co.) died at his home in Brooklyn, August 13, at the ripe age of 88. He leaves a large family of sons, daughters and grandchildren. His son, Mr. D. T. Wilson, is well known and prominent in the carriage trade. His funeral was almost a civic event in his home city, as his life had been one of great public and private activity and full of honor in each field.

Mr. Wilson was born in New York City in 1823, moving over to Williamsburg when that section was highly considered for a residence.

Aside from his manifold and honorable activities, his great hobby was industrial training. With the late George H. Fisher, he was intimately connected with the Eastern District Industrial School, to the presidency of which he was elected on October 12, 1878, and which he served in an official capacity until the time of his death.

He was always practical and unselfish, and retained to the last those qualities which made him universally respected and beloved. He was always doing something for his fellow men and there were few men who had more friends or who were more highly esteemed. When frequent illness made him unable to properly attend to his business interests, he insisted on resigning the positions which he held on various boards and committees. In this way he gave up his office as one of the three members of the finance committee of the German Bank and of the governing board of the Industrial Training School.

"If a man is not able to do his work, he should step aside and let some one younger and more capable do it and get the credit for it," he declared.

Mr. Wilson died of angina pectoris. He had been in poor health for about a year, and his last illness, was of a few weeks' duration. Three sons and two daughters survive.

THE MURPHY PRODUCTS.

The Murphy Varnish Company does things very well and thoroughly. A recent booklet entitled "Quality and Economy in Varnishing" goes into a difficult subject with painstaking care and direct simplicity. The price-list descriptions are something more than mere cataloging of the goods. Information of value is purveyed. Some of the pages give details about the care of varnished things that are most timely. It is information that has appeared in *The Hub* through the years, because it is a kind of information that must be mentioned in speaking of the details of varnishing, but it is, and always will be, timely.

Last month we credited to an English journal, *The Decorator*, extracts from this book. We compliment the journal on its perspicacity in recognizing good matter, but it is hardly fair to the Murphy booklet not to credit.

THE SECHLER FROLIC.

Employees of the D. M. Sechler Carriage Co., Moline, Ill., had their annual picnic on Campbell's island. There were over 300 in attendance. In charge of the sports were Albin Youngren, Elon Weaver, Fred Abramson, Louis Mills and Axel Renstrom. The big attraction of the afternoon was a ball game between employees.

BREWSTER & COMPANY'S NEW FACTORY.

The illustration of the new factory of Brewster and Company in Long Island City, (a part of New York City so named for local convenience), which we present in this number, does not do the building justice. It is not only larger, but more imposing than the impression the cut conveys. It is located on the plaza facing the approach to the superb Queensboro Bridge which spans the East River from the Long Island shore to Manhattan Island, one of the many bridges connecting the greater city. The approach on the Manhattan side is at 59th street, making access to the factory most convenient.

The building is easily the outstanding object of prominence, fronting 200 feet on the plaza and extending 367 feet facing the bridge. The great clock dial in the tower is more than fifteen feet in diameter, and may be seen and read from afar.

This is the largest and most complete, as well as the most noteworthy factory ever erected in this country by a carriage company dependent upon individual sales to private patrons. Its plans were gone over, refined, and gone over yet again, until it is believed nothing essential has been overlooked, which is not an idle statement, in view of the experience that was drawn upon. All construction is reinforced concrete throughout, not a wooden floor in the workshops. All the windows are glazed with prismatic glass. Its height is six stories. It is available for its

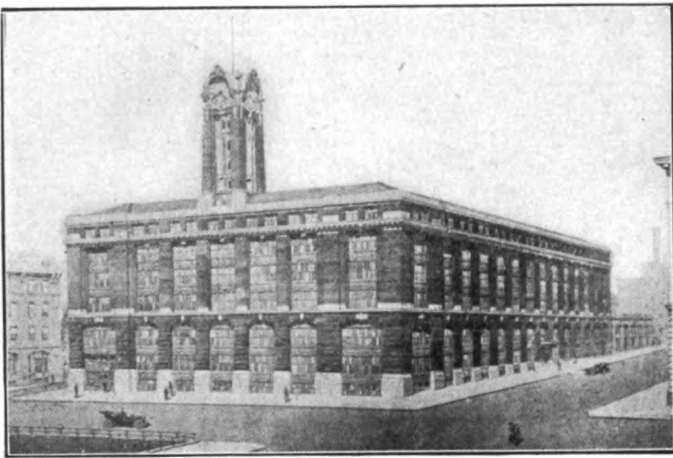

intended purposes from basement to and including the roof, the latter affording place for airing, cleaning, etc., a vacuum cleaning plant being one of the features. Unlike the ordinary carriage shop of antiquity in the matter of elevators, these are centrally located in the building, and deliver loads onto the roof. The delivery is from either end so that the vehicle can be run direct to the spot where wanted. The power plant to operate this great building consists of four 225 h.p. engines so combined that there can never be a stoppage due to breakdown of any particular unit. The battery of boilers is also designed to supply steam in excess of ordinary requirements, and the devices that have been installed to make the work of stoking them mere play, are the product of the very latest practice. As for the coal, it is taken from the water front in wagons, dumped at the street level of the factory in chutes, and from that point is easily hand-stoked. All through the building there is that same attention paid to the labor-saving details whose purpose is to promote efficiency of operation. There is not a belt needed to drive a machine from shafting. Machinery is individually motor-driven throughout. It would be impossible to go into details in the space of a brief advance notice, so only some salient features of the departments will be touched upon at the present time. Let us commence on the top floor and descend.

The sixth floor is to be used for storage, including the vehicles of patrons. It is quite a feature in itself to be able to afford fireproof storage to those desiring security for non-used vehicles. It is also a new departure in the matter of safety. There is ample room also for the company's own needs. The trim shop uses

a fine space on the fifth floor. It may be stated right here that all plans are made to cover the needs of the larger dimensions of motor car work, so that it is a mere sliding scale movement to adapt facilities to horse-drawn vehicles as needed. And while plans have been liberally laid out, there is no waste effort, no lost motion. Everything fits and works together like the movement of a big clock, all regulated by that live pendulum, the superintendent, Mr. Dalzell, aided by the suggestions of Mr. William Brewster. It has been a masterly piece of planning.

Heavy body work is handled on one section of the fourth floor, while the japan ovens, color grinding, lamp making, as also the chassis finishers, are housed thereon. The auto body maker needs more bench room and more assistants than the old-time body maker. Here he has it in abundance, plus the most splendid light by which to work. The "mill" is on the third floor, that is, such sawing, planing, etc., of wood stock as needed, is here handled, and again the detail is shown by the way the dust and shavings are carried away by a perfect exhaust system. Also more body makers are accommodated on this floor. The arrangement of the glue tables in the center of the department is such that the glue is constantly kept at the right temperature without attention on the part of the user. Glue always "just right" is an important achievement in any carriage factory, and not always on tap. The chassis fitter, a new development, is also housed on this floor, as are likewise the body repairers. In another section the body receives its first attention at the hands of the painter. When to this is added the lock-making shop, the forges for small work that is necessary before the vehicle gets to the smith-shop, some notion of the dimensions will be realized. The tire setting and the wheel work are here done. It would delight a practical factory man to note how neatly the scheme of evolution is adjusted to make the work progress without interference. Space will not permit of going into details. We must, however, mention a neat solution of the varnishing problem. When the body comes to the finishing coat process it is run onto a turntable that just accommodates it. This table turns on ball bearings so easily that the painter can move a big body with his hands. He turns it to suit his requirements, and just flows varnish without moving. When the work is finished the job is run into a kind of alley just wide enough to accommodate the body lengthwise, but which will take several before being filled to capacity. The alley is a dust-proof receptacle. When dry the body runs out at the opposite end. There are a number of these alleys in parallel lines. There is no such thing as turning back in any part of the process. It is just a steady evolution from the working draft to the repository floor. The same sort of turn table is used for the final inspection. The vehicle is turned to and fro by the porter while the minutest detail is passed under inspection, and the vehicle that passes such a specialist examination is certainly Brewster standard—the most exacting we know of.

The second floor, on which are located repository and offices, is just the product of the sum in addition that has been worked out elsewhere, so we will pass it. It is the greatest repository floor in area and light in the country, probably.

The basement is only slightly below sidewalk level, with fine light. Here the smith works under new conditions, as his forge is set away from its window so the light will fall on the work where it is needed, in place of illuminating the countenance of his willing helper as was the practice from time immemorial. The worker on the chassis has a pit or well under his work so he can get at it from all angles, for work and for inspection. The stock room details are worked out on the lines followed by the big corporations by which there is an account kept with every tool, bit of material, or anything whatsoever in the way of supplies, by a system of checks and records. There is no waste.

This, in brief, is the way of the arrangement of the finest carriage and automobile "shop" in the land, and possibly in the world, thus maintaining the prestige of the great house of Brewster and Company, of Broome street, from generation to generation.

PROTEST REGARDING EXPRESS RATES.

A petition asking an investigation by the Interstate Commerce Commission of express rates, etc., has been filed by the Merchants' Association of New York, the Boston Chamber of Commerce, the Chicago Association of Commerce and 121 other commercial associations. The petition declares that merchants have suffered for many years past, and now suffer, from unjust and unreasonable charges.

It is alleged that the net returns to the express companies have been out of all proportion to the service performed and capital invested. The enormous accumulations and dividends paid upon a small investment establish the extent to which extortion has been practiced. The case of the Great Northern Express Company illustrates this point.

It is alleged that that company was organized in 1892, with a capital of \$100,000; that the total cost of the property, etc., to June 30, 1909, amounted to only \$71,288.91; and that upon this total investment the company has paid during the past ten years \$3,200,000 in dividends, and that in addition it has accumulated \$1,488,881.58, all of which have arisen from its charges to the public, after payment to the railroad companies of from forty to fifty-five per cent of gross earnings.

It is set forth that the express companies pay the railroads for transportation approximately 50 per cent of the gross express receipts, and that this basis of payment results in an excessive overpayment to the railroads for transporting small parcels. The sole service rendered by railroad companies in express transportation consists of train haulage. The subdivision of the weight hauled into numerous separate parcels does not increase the cost of rail hauling, which is affected only by the aggregate weight. The train haulage charge, therefore, should not increase because of subdivision of weight into small parcels. In practice the increased rate imposed for subdivision of weight is exacted not only for terminal service, but for train haulage service also, so that the haulage charge becomes grossly disproportionate to the fair value of the service rendered.

These petitioners allege that the practice of the express companies is to increase not only the charge for hauling, which is properly increased in proportion to distance, but also the charges exacted for purely terminal services, and thereby a much higher charge for terminal service is imposed at one point than at another for identical service. The cost of transportation by rail increases in proportion to distance, but the element of distance does not enter into the cost of terminal service. Nevertheless the basis upon which charges are made by express companies increases the charge for such terminal service in proportion to the mileage covered by the haul, so that in the case of a haul of three thousand miles the charge for terminal service is charged for similar terminal service in the case of a haul of twenty-five miles.

The petition further complains of the accumulation of high local rates upon through shipments passing over the lines of two or more express companies whereby charges are exacted for two or more terminal services which are not rendered and an excessive rate exacted for the transportation service.

The petition further sets forth alleged grievances in connection with express money orders, the public often being required to pay extra charges to secure the liquidation of such orders.

The numerous organizations throughout the United States engaged in this movement have retained Hon. John W. Griggs, former attorney general of the United States, and Hon. Ben. L. Fairchild, as counsel.

The petition will be considered by the Interstate Commerce Commission after it reconvenes in the Fall.

M. N. Buckeridge has just completed large cement additions to his carriage shop in Port Huron, Mich. He will hereafter make a specialty of automobile wood work, auto painting, etc. The new shops have over 500 feet of floor space.

OBITUARY

John Finn, of Cincinnati, Ohio, died at the age of 76. He was well known and esteemed in his home city.

Bernhard Kolbe, pioneer carriage builder of Colorado, died in Denver. He leaves a widow and two children.

Dighton L. Segur, 86, one of the oldest carriage builders in Connecticut, died in West Suffield. He leaves a brother, sister and three sons.

Gus. A. Schnabel died in Oakmont, Pa. He conducted a factory in Pittsburg. He was 57. Death occurred after a long illness. He leaves a widow and five sons.

John F. Wessinger, of Dover, N. H., died July 26. He had just returned home from his day's work at his carriage shop and was about to wash his hands when he was suddenly stricken and instantly passed away. Mr. Wessinger was born in Masardis, Me., his age being 57 years, 11 months and 6 days. He is survived by a widow, daughter, two sons, brother and a sister.

Henry Siebke, St. Louis, Mo., founder of the firm of H. Siebke & Sons, died at the age of 76. Three sons and four daughters survive.

Albert Schmidt, a wagon maker in New York, committed suicide by shooting, August 16. He was the son of Conrad Schmidt, who lived for many years at Rivington and Mangin streets and followed the trade of wagon maker. He was one of most popular men where he lived, and was noted for his good nature and cheerfulness. He moved the factory to East Twenty-second more than ten years ago. Recently a partner left him and started a rival shop. Schmidt became very downcast. He said he could see nothing but bankruptcy ahead. He leaves a widow.

BRANCHES EVERYWHERE.

Arrangements have been made by the United States Motor Company for the establishment of a branch house in Des Moines. The new branch will take the lease, stock and good will of the Capital Auto Company, whose officers and employees go to the new concern.

W. S. Hathaway, supervisor for the United States Motor Company, managing all Maxwell and Columbia branches west of the Mississippi River, was in Des Moines recently, and made the final arrangements with A. G. Bigelow, manager of the Capital Auto Company. The branch will be operated under the name of the United Motors Des Moines Company. It will represent the Maxwell and Columbia cars throughout the larger part of Iowa, controlling all agencies from Des Moines. Mr. Bigelow will be treasurer of the new branch.

LARGE ORDER.

George B. Ogan, western manager for the Hess Spring and Axle Company, reports that the Banner Buggy Co., of St. Louis has placed with his concern a record-breaking order for vehicle axles, the specifications calling for 25,000 sets. These specifications will fill thirty freight cars. The shipments of axles to the Banner Buggy Company the past twelve months total 65,000 sets.

DEAL CLOSED.

The Defiance (O.) Carriage Company has closed a deal by which it purchases the property occupied by it. This means that the carriage factory and the wagon service department of the United States Express Company will be retained, the carriage company having an agreement with the U. S. company by which the company gives it its wagon and truck repairing.

Trade News From Near and Far

NEW FIRMS AND INCORPORATIONS.

Universal Motor Truck Co., Detroit, Mich., incorporated with a capital of \$350,000.

Argo Electric Vehicle Co., Saginaw, Mich., has been incorporated with a capital of \$200,000.

The E. C. Russell Co. has been organized at Toledo, O., to manufacture auto trucks with a capital of \$25,000.

The Cecil E. Gibson Motor Car Company, Indianapolis, Ind., capital \$25,000, has been incorporated by C. E. Gibson and W. R. Wheeler.

The Scioto Auto Car Co., Chillicothe, Ohio, incorporated with a capital of \$150,000, by F. C. Arbenz, Richard Enderlin, C. A. Froman.

The Interstate Auto Co., Duluth, Minn., has incorporated with a capital of \$25,000 by W. G. Baldwin, J. T. Placha, J. A. Smith and C. S. Lawtin.

Pope Motor Co., Jersey City, N. J., capital \$125,000, has been incorporated by Frank Koch, W. C. Fisk and others, to manufacture automobiles.

New Jersey Overland Co., Newark, N. J., to manufacture automobiles, capital \$100,000, has been incorporated by William F. Acker, R. D. Crocker.

The Mais Motor Truck Co., Indianapolis, Ind., has been incorporated with a capital of \$500,000 by A. W. Markham, E. W. Spencer and Charles Fisher.

Ft. Wayne Automobile Mfg. Co., Ft. Wayne, Ind., has incorporated with a capital of \$25,000 by G. P. Dudenhofer, H. E. Bueker, G. T. Fox and others.

The Edward F. Alf Co., Cincinnati, Ohio, vehicle trimmings, incorporated with a capital of \$25,000 by Edw. F. Alf, Harry C. Day, Bernard Alf, D. F. Cash.

Victor Motor Car Co., Camden, N. J., to manufacture and deal in automobiles, capital \$150,000, has been incorporated by J. H. Harrington and J. F. Harrington.

Cote Automobile Co., Tupper Lake, N. Y., to manufacture auto sleighs and cars, etc., capital \$15,000, has been incorporated by Michael Kennedy, C. H. Marsha and others.

The G. W. Kelsey Manufacturing Company, Hartford, Conn., incorporated with a capital of \$250,000 to manufacture small motor vehicles to be known by the name of "Motorette."

The Walden W. Shaw Livery Co., Portland, Me., has been incorporated with a capital of \$1,000,000 by C. E. Easton and A. F. Jones for the manufacture of automobiles, taxicabs, etc.

Guarantee Rubber Tire Company, Edgewater, N. J., capital \$10,000, to manufacture automobile tires, has been incorporated by E. J. Forhan, G. F. Martin and others, New York City.

Peerless Motor Car Co. of Illinois, Chicago, Ill., to manufacture automobiles and accessories; capital, \$60,000; has been incorporated by Louis E. Hart, Jasperson Smith and others.

The Consolidated Motor Car Co., has incorporated with a capital of \$4,000,000. Incorporators G. A. Howell, L. R. Canfield, Thomas D. Canfield, J. L. Bradley, Cleveland, Ohio.

The Wilson Automobile Company, Troy, N. Y., to manufacture and deal in motors, engines, automobiles, etc., capital \$10,000, has been incorporated by John D. Wilson, F. H. Deal.

The DeLuxe Motor Vehicle Company, Cleveland, Ohio, has been incorporated with a capital of \$100,000 by W. G. Moore, W. P. Wynn, R. M. Dorrance, G. A. Gaston and M. L. Thompson.

The Staner Motor Car Company, Cincinnati, Ohio, has been incorporated with a capital of \$25,000 by L. K. Emerson, G. W. Pratt, R. L. Dollings, Parker K. Gale, Stanley M. Adams, A. L. Parker.

Dugger & Goshorn Co., Memphis, Tenn., manufacturers of beams, wagon stock, etc., has been incorporated with a capital of \$30,000. Incorporators: J. O. Goshorn, Charles Hudson, H. R. Boyd, E. L. Fuller.

The Delmont Motor Vehicle Co., Castleton, N. Y., to manufacture and repair motors, engines, vehicles, etc., capital \$25,000, has been incorporated by A. C. Cheney, O. D. Woodford and others at Castleton-on-Hudson.

The American Tire and Rubber Company, of Akron, Ohio, manufacturers of all classes of rubber goods, has been incorporated with a capital stock of \$200,000 by Frank L. Kryder, Harvey Musser and J. R. Huffman.

The Motor Car Co., New York City, to manufacture motors, engines, boats, etc., capital \$100,000, has been incorporated by Charles L. Holden, 1919 Seventh avenue, and J. H. Hershfield, 17 W. 23rd street, New York City.

The International Automobile League Tire and Rubber Co., Buffalo, N. Y., has been incorporated with a capital of \$1,000,000 for the manufacture of automobiles and rubber by Alfred C. Bidwell, 234 N. Division street, and others.

The Great American Automobile Company, of Indianapolis, Ind., capital \$1,500,000, has been incorporated by Samuel Quinn, Jr., Charles N. Lee and L. H. Van Briggie, of Indianapolis, to manufacture automobiles, motor vehicles and motor trucks.

Articles of incorporation of the Syracuse (N. Y.) Coal Wagon Company have been filed. The company is now engaged in the business of making and selling wagons. The directors are Chester A. Houseknecht, R. Louis Post and Victor Sanger.

Articles of incorporation have been filed by the Ohio Regal Auto Co., organized to do business in Detroit and Cleveland. The capital stock is \$100,000, all paid in cash, and the stockholders are F. W. Haines, J. E. Lambert, Burt Lambert, C. R. Lambert and F. L. Pierce.

The Dayton Auto Truck Company has been incorporated at Dayton, Ohio, with a capital of \$50,000 by Louis L. Webner, L. M. Pooekand and others. The company will erect a factory for the construction of trucks to be used by breweries, though definite plans have not yet been completed.

The Case Motor Car Company, New Bremen, O., has been incorporated with a capital of \$50,000. The incorporators are J. H. and Edmund Grothaus, J. F. Laufersieck, Otto J. Doesel, Louis Kuenke. The business will be devoted exclusively to the manufacture of motor trucks of the commercial type.

A. E. Paegel, S. C. O. Furbush, and W. P. Cockey, Minneapolis, Minn., are the incorporators of the Cycloid Manufacturing Company. The company is now manufacturing motor vehicles of all kinds in a small way, but purposes to branch out and erect a larger building. The capital stock is \$600,000.

Increases in Capital Stock.

The Electric Carriage & Battery Co., Minneapolis, Minn., increased capital to \$100,000.

The Krit Motor Car Co., Detroit, Mich., has increased its capital from \$100,000 to \$250,000.

The Chalmers Motor Co., Detroit, Mich., has increased its capital from \$300,000 to \$3,000,000.

The Rayfield Motor Car Co., Springfield, Ill., has increased its capital from \$74,000 to \$150,000.

The Willys-Overland Co., Toledo, Ohio, has increased its capital from \$2,000,000 to \$5,000,000.

The Chicago Coach and Carriage Co., Chicago, Ill., has increased its capital from \$15,000 to \$200,000.

The Lexington Motor Car Co., Connerville, Ind., has increased its capital from \$50,000 to \$100,000.

BUSINESS CHANGES.

Sunday & Faber have purchased the Boetcher carriage shop at Mendota, Ill.

W. C. Freeman Co., Craig, Neb., implements, vehicles, etc., has sold to J. M. Bovee & Son.

Bailey Motor Truck Co., Detroit, Mich., has changed its name to Federal Motor Truck Co., capital \$15,000.

Dale & Erwin Munson, Deerfield, Mich., vehicles and implements, have sold their business to Glenn Bliss.

The Welsh Carriage & Implement Co., New Orleans, La., has been succeeded by the Bertrand Davis Hardware Co.

The Anherst Motor Car Co., Detroit, Mich., has been reorganized as the Barnes Motor Co., with a capital of \$300,000.

The Amos-Pierce Automobile Company, of Syracuse, N. Y., will be succeeded by the Standard Automobile Company.

Thomas W. Williams, formerly of Laporte, Ind., has sold his Michigan City Carriage Works to Barney Switzer, of South Bend, Ind.

Eli Skeppstedt, of Odebolt, Iowa, has purchased the interest of the late John A. Reynolds in the firm of Reynolds & Kistler, blacksmiths and wagonmakers.

Arthur C. Bly, Moline, Ill., a carriage dealer, sold his stock and despite the efforts of his friends he cannot be located. He had \$500 in his possession when last seen.

The International Harvester company has purchased a controlling interest in the Chatham (Ont.) Wagon Company, and will make extensive additions to the plant.

A deal has been closed at Racine, Wis., by which the Fish Bros. Manufacturing Company, of Clinton, Iowa, purchased the farm wagon department of the Racine-Sattley Company. The latter company will probably engage in the manufacture of automobiles.

The Alco Motor Sales Company, Minneapolis, Minn., has absorbed the Victoria Motor Company, and has taken also the line of automobiles which the latter company has been selling since its organization. The principal stockholders of the Victoria company have taken stock in the Alco company.

Negotiations have been completed between the J. I. Case Threshing Machine Company of Racine, Wis., and the Pierce Motor Company, of Racine, by which the former concern absorbs the entire output of the automobile factory and acts as distributor for the Pierce-Racine, which in future will be known as the Case car.

Negotiations for the sale of the Abbott Motor Co., to interests centering in Warren, O., have resulted in an agreement. It is understood that the purchase price will give the stockholders a handsome clean-up, and that the new owners now engaged in the manufacture of auto accessories on a large scale, will build a new auto plant in Detroit.

IMPROVEMENTS AND EXTENSIONS.

The Anderson Carriage Company, Evanston, Ill., is to build a one story brick building to cost \$16,000.

Plans for a modern carriage shop for the Waller & Porter Company, Nashville, Tenn., to replace the present one have been completed.

Plans for the three story factory building at the Eller Carriage and Wagon Manufacturing Company, Houston, Texas, have been changed from three to four stories.

Charles F. Furbish, the well known blacksmith and carriage manufacturer of Dover, N. H., is contemplating changing his factory for the repairing of automobiles.

The Canada Carriage Company, Brookville, Ont., is erecting a building at a cost of \$10,000, which will be equipped with machinery for the manufacture of automobiles.

The Brodesser Motor Truck Company has bought land in Juneau, Wis., upon which a large auxiliary factory with a capacity of 200 motor trucks a year will be erected.

The Matthews Implement and Vehicle Company, Newton,

Miss., is planning for the erection of a brick business house, which the firm will occupy with its stock of vehicles and farm machinery.

The foundation for the structure to be occupied by the Northwestern Wheel and Wagon Works at Bellingham, Wash., has been completed and work of erecting the upper stories will soon be under way.

Plans for the erection of a three-story addition to its factory are now being made by the Shaver Carriage Company, of Des Moines, Iowa. An addition 65x150 feet to cost about \$20,000 is being considered.

The Maxwell-Briscoe Motor Company, of New Castle, Ind., is considering plans for the further extension of its tremendous buildings. The addition, when completed, will be 160 feet in width across the south end of the present building.

The Baltimore Buggy Top Manufacturing Company has closed a deal for a lot with a frontage of 75 feet and a depth of 100 feet at Maryland and Mount Royal avenues. The company will erect a three-story factory and salesroom on the site.

The Anderson Carriage Company, of Detroit, Mich., is putting on an addition which when completed will give 100,000 extra feet of floor space. The entire factory is being remodeled to make way for a new branch of the industry, the making of electric commercial trucks.

The Hollingsworth Wheel Company closed a contract with the Baltimore & Ohio Railroad Company for a tract of land in Hagerstown, Md., as a site for its factory. The buildings will be constructed of brick, the main factory 40x106 feet, two or three stories. The dry room will be 20x40 feet. The factory will employ 30 to 50 hands. In four months the factory will be under way. The buildings will be equipped with modern machinery for the making of rims, spokes, hubs and wheels.

THINGS PROPOSED.

The Hale Buggy Company, Anniston, Ala., with a capital of \$25,000, will build a buggy plant, to have a capacity of ten vehicles a day.

It is said the Willys-Overland Company of Toledo will establish a branch in London, Ont., and will have cars ready for sale next season.

Wheeling, W. Va., capitalists are heavily interested in the Scio-to Auto Car Company, which will build a plant at Chillicothe, O., for the manufacture of automobiles.

Steps to secure a wagon factory for Wichita Falls, Tex., were inaugurated at a meeting of the Chamber of Commerce directors. The proposition submitted was by Missouri parties.

The Business Association of Lisbon, Ohio, announces that it has secured a \$50,000 automobile factory; \$25,000 worth of the stock having been already subscribed. The proposition was made to the Business Association by A. H. Wyatt, of Cleveland.

Parties who are conducting a wagon making establishment at Hills, Minn., who are looking for a larger field, have been in Sioux Falls, S. D., looking about for a site to move their business. There are numberless sites but few that are just suited to the business of wagon making.

C. H. Haberkorn has purchased a manufacturing site of between three and four acres in Detroit, Mich., It is said, although no announcement is made by persons directly interested, that the land will be the site for a manufactory of a motor truck company, the organization of which is soon to be completed.

The Commercial Club of Brownwood, Texas, has a proposition from a wagon and buggy factory, which proposes to establish a factory there if the town will give a bonus of \$15,000. The club has the matter under advisement, but it is doubtful if the amount asked will be raised.

Eastern capitalists whose names are withheld, will soon take over the DeTamble Motors Company at Anderson, Ind. The consideration will be close to \$100,000. The prospective owners, E. S. Tamble said, will continue the factory in operation, and if any change is made it will likely be to increase the capacity of

the local plant. It was located there about two years ago for a cash bonus of \$50,000, all but \$18,000 of which has been paid. The company was formerly known as the Union Speed Changing Pulley Company, of Indianapolis.

O. L. Houle is interested in the location at Escanaba, Mich., of a large carriage factory and is now looking for a proper site. Mr. Houle represents a large carriage making concern that has been in business at its present location for the past 30 years, and is considering a change in location, and if a favorable site and proper shipping advantages can be offered it is believed that the industry would be moved to Escanaba.

The Faulkner-Blanchard Motor Car Co., will soon be incorporated to manufacture six-cylinder cars in Detroit. M. A. Faulkner is president and general manager of the new concern, and among those interested are Mark W. Allen, Daniel M. Graham, Samuel L. May, Dr. L. C. Moran, Robert Shellenberg, Dr. Edwin Frumwiler, William Lavin, John A. Stewart, Louis H. Gern, R. L. Allen and Eugene T. Bernart.

The citizens of Alpena, Mich., evolved a unique scheme to bring a motor car manufacturing company to that city. At a public meeting a committee of citizens was appointed to secure a tract of land within the city limits. This tract was plotted into 250 lots, which sold at \$200. After \$50,000 had been raised a group of prominent Alpena bankers and capitalists, with others interested in the motor car business, organized the Alpena Motor Car Co., with a capital stock of \$450,000. The company is said to have sold its output for 1911.

PERSONAL.

Samuel Clay Harlan, of Columbia, Ala., has accepted the position of general manager of the Florence Wagon Works.

Julius G. Kirsten, who went with the Anderson Carriage Co., has quickly made good and will go to Kansas City to be branch manager for the handling of Detroit machines.

Nels Halverson, twenty years superintendent of the Stoughton (Wis.) Wagon Company, has moved his permanent residence to Edgerton. He will be manager of the Edgerton Wagon Company, recently organized.

Thomas A. Bohan, for twenty-one years employed by the Kentucky Wagon Manufacturing Co., at Louisville, Ky., has resigned his position to become general manager of the Kentucky Packing and Provision Company, of Louisville.

Chester R. Freeman, bookkeeper at the Pontiac (Mich.) Wheel Works, was found dead in his bathroom with the gas turned on. It was evident that he killed himself and premeditated the act. No cause is known for his act. He was 56 years old.

Mr. J. M. Cochran, who for a year past, has been manager of the sales department of the Rock Hill (S. C.) Buggy Company, will move to his old home in Barnesville, Ga., where he will have his headquarters. He will take up his former work as traveling salesman for the buggy company, with Georgia as his territory.

At the annual meeting of the Firestone Tire & Rubber Co., held in Akron, August 24, the former board of directors was retained and the following officers were re-elected for the coming year: H. S. Firestone, president and general manager; Will Christy, vice-president; S. G. Carkhuff, secretary, and J. G. Robertson, treasurer.

As soon as the stock on hand can be disposed of, the Morris Woodhull Company, Dayton, Ohio, manufacturers of high-grade buggies and other vehicles, will go out of business. The firm has been in operation for a period of twenty-two years. Mr. Woodhull believes that twenty-two years in business is enough, and intends to retire.

Manager M. A. Steele announces that the Henney Buggy Co. and the Freeport Carriage Co. will, as soon as the necessary culinary arrangements can be made, inaugurate a plan which provides noonday lunch for department superintendents, foremen and inspectors of the two big Freeport plants owned by the Moline Plow Co. The purpose of the management is to bring the

heads of these departments in touch with each other and, at each day's lunch, typewritten reports will be taken up and discussed.

The Ford Motor Co., Ltd., of Canada, has just paid its stockholders a 100 per cent cash dividend. The fat division came as a birthday souvenir to the stockholders, the Canadian branch being just 6 years old on the day the stockholders received their slips. Since 1904 the company has paid 141 per cent. There are about 50 stockholders, the majority of whom are Canadians, but the controlling interest is held by Henry Ford, president; James Couzens, vice-president, and G. H. McGregor, secretary and treasurer.

Stockholders of the Glen Wagon Company, Seneca Falls, are considering a plan to more than double the capital stock of the concern, and will vote on the question. It is assumed that the proposition will be adopted. The company now has \$75,000 capital stock out. A new issue of \$200,000 is proposed. The new issue is to consist of \$75,000 preferred stock and \$125,000 common, the former to pay a 7 per cent. cumulative dividend annually from the net earnings of the company before any dividends are to be paid on the common.

FIRES.

Fire destroyed the St. Louis Axle Company's plant on August 8; loss estimated at \$30,000.

The J. L. Aubry Wagon Company's plant at Tacoma, Wash., sustained a \$3,500 fire loss; partially insured.

The plant of W. S. Frazier & Co., Aurora, Ill., manufacturers of sulkies, carts and carriages, suffered a \$5,000 loss by fire; insured.

Two frame buildings occupied by the Central Carriage factory at Shreveport, La., were gutted by fire, most of the contents being destroyed.

The Lewisburg (Tenn.) Carriage Company's plant was scorched to the tune of \$400 in a conflagration which destroyed several other buildings. Insured.

BUSINESS TROUBLES.

Involuntary petition of creditors has been filed to have Sterling Vehicle Company, Harvard, Ill., declared bankrupt.

Clarence J. Sipple, London, Ky., doing a wholesale and retail business in buggies, wagons, etc., under the name of the Laurel Feed Company, has been adjudged a bankrupt.

J. L. Cox, receiver of the Keystone Wagon Works, Reading, Pa., has filed his second account, which shows claims aggregating \$190,175.81, with a balance for distribution of \$22,043.22, allowing a pro rata share of 11.59 cents.

Thomas J. Kauffman, receiver of the Kauffman Buggy Company, of Miamisburg, Ohio, has filed his final account and been discharged. The report shows a disbursement of \$156,378. The total claims against the company amounted to \$105,163.12.

An involuntary petition in bankruptcy has been filed against Ferd F. French & Co., Ltd., Boston, Mass., carriage manufacturers, at the instance of these creditors: Henry Lang Co., Newark, N. J.; Walter E. Frost, Boston, and Martin L. Cate, Boston. The liabilities are estimated at about \$30,000.

As receiver for the Anderson Carriage Manufacturing Company, Anderson, Ind., W. T. Durbin has filed an inventory statement. The inventory shows stock and equipment valued at \$68,364.24; cash on hand, \$218.15; bills receivable, \$694.36; accounts litigation, \$12,799.44; accounts not regarded good, \$12,422.44. At a meeting of creditors, O. B. Banister and C. H. Davis, of Detroit, Mich.; E. F. Yarnelle, Ft. Wayne, and B. F. Mars, Anderson, were elected a creditors' committee to confer with the receiver regarding the company's future.

Creditors of the Worth Motor Car Manufacturing Company, of Kankakee, Ill., forced the concern into the hands of a receiver. They charge that Samuel R. Hunter, vice-president, and W. A. Duncan, a stockholder, removed machinery and an auto-

mobile valued at \$6,000 from Kankakee to Gary, Ind. Judge Sanborn in the United States Court issued an order restraining the two from disposing of the assets. Charles H. Fisher was appointed receiver.

Petition has been filed in United States court asking that the Demot Car Co., organized under the laws of New Jersey, but having factory in Detroit, Mich., be declared bankrupt. Petitions allege liabilities of over \$100,000 and declared that on August 3 the company's officials, in writing, declared their inability to meet claims and willingness to be declared bankrupt. The petitioners are the General Sales Co., with a claim of \$308, the Central Foundry Co., \$2,557, and the Williams Carburetor Co., \$96. They say that the company committed acts of bankruptcy May 4 and 8 when \$1,480 was turned over to the New York Gear Co., and \$2,000 to the Detroit Radiator Co.

RECENTLY GRANTED PATENTS OF INTEREST TO THE VEHICLE INDUSTRY.

- 952,864—Motor Chair. Philbert Auger, Easthampton, Mass.
 952,900—Draft Equalizer. Henry J. Heider, assignor to Heider Mfg. Co., Carroll, Iowa.
 952,875—Pneumatic Tire. Louis B. Krum, Chicago, Ill.
 952,748—Washer for Wagon Bolsters. James Y. Martin, Arlington, Texas.
 952,751—Wagon Bed and Hay-rack. John L. McIntyre, Georgetown, Ky.
 952,623—Wheelwright Machine. Augustus A. Merrill, Mallard, Iowa.
 952,838—Tenoning Machine. Jose Ojanguen, Havana, Cuba.
 952,943—Wagon. Harry Peterson, Brooklyn, N. Y.
 952,951—Vehicle Tire. Wm. W. Scott, Hampton, Va.
 952,487—Spoke-Tightening Device. Reinhold Weidemann, assignor of one-half to M. Gabert, Houston, Texas.
 952,719—Carriage Bow Repairing Device. David W. Wilson, Spokane, Wash.
 40,586—Design, Automobile Tire. Iva B. Kempshall, Boston, Mass.
 953,190—Shock-Absorber for Carriage Bows. Everett W. Redinger, Jr., Anchorage, Ky.
 953,509—Wagon Body. John W. A. Bird, Muncie, Ind.
 953,658—Adjustable Anti-skid Device. Don E. J. Brackett, Cleveland, Ohio.
 953,312—Road Vehicle, Matthew R. D'Amora, New York, N. Y.
 953,028—Automatic Oiler for Wheels. Wm. J. Jones, Hamilton, Ont., Canada.
 953,477—Pneumatic Tire Rim. Arthur L. Lockwood, Jackson, Mich.
 953,549—Spring Wheel. Joseph R. Place, Harvey, Ill.
 953,350—Air Deflector for Vehicles. Paul J. Schrader, Chicago, Ill.
 953,157—Jack for Automobiles. Edwin I. Spencer, Wichita, Kan.
 953,645—Wheel. John H. Story and F. C. Winkel, Woodbury, N. J., assignors to H. D. Weed, Syracuse, N. Y.
 953,357—Steering Mechanism. Godfrey E. Sundall, assignor of one-half to L. H. Green, Warren, Pa.
 953,656—Sleigh Brake. Charles E. Yndero and V. K. Yndero, Aberdeen, Wash.
 954,075—End-Gate for Wagons. Alonzo W. Bowen, Neola, Iowa.
 954,375—Demountable Rim. Eli J. Bushy, New York, N. Y.
 954,377—Sled Runner. Jonas Bystrom, Tower, Minn.
 954,255—Vehicle Tire. Horace O. Clark, New York, N. Y.
 954,378—Draft Gear. Charles S. Corning, Chicago, Ill.
 953,780—Vehicle Wheel. Robert C. Duguld, assignor to D. Ward, Detroit, Mich.
 953,783—Dump Wagon. Charles M. Haeske, South Bend, Ind.
 954,392—Securing Device for Wagon End Gates, Ludwig Hillan, Wentworth, S. D.
 954,101—Wind Shield for Automobiles. Georges Huillier, Paris, France.
 953,698—Steering Gear for Automobiles. George Laning, LaSalle, Ill.
 954,317—Vehicle. Daniel W. Martin, Lufkin, Texas.
 953,916—Vehicle Wheel. Edward F. Maybaum, New York, N. Y.
 953,750—Vehicle Spring. Ralph W. Morse, Lansing, Mich.
 954,124—Wheel. Edward G. Murtaugh, Greenwood, S. D.
 954,043—Pedal Action. Levi W. Norcross, Fort Worth, Texas.
 954,323—Tire-tread. Denis T. O'Sullivan, West Orange, N. J.
 953,710—Draft Equalizer. James B. Pollon, South West City, Mo.
 954,048—Wheel. Cyrus W. Price, Greenfield, Ohio.
 953,717—Fifth Wheel for Vehicles. Matthew M. Sherwood, Scranton, Pennsylvania.
 954,068—Draft Gear. Arthur L. Stanford, Chicago, Ill.
 953,804—Adjustable Wind Screen for Use on Vehicles. Charles Steane, Coventry, England.
 954,145—Wagon Dump Lifting Jack. Benjamin M. Steele, Peoria, Ill.
 954,224—Vehicle Tire. Benjamin C. Swinehart, Akron, Ohio.
 954,225—Vehicle Tire and Fastening Means Therefor. James A. Swinehart, Akron, Ohio.
 954,361—Vehicle Tire. Herman B. Tobias, Hoboken, N. J.
 953,723—Wind Shield for Vehicles. Cowles Tolman, assignor to The Holcomb Co., New Haven, Conn.
 954,238—Wagon Brake. Wm. E. Woods, Griffin, Indiana.
 955,034—Wagon and Auto Brake. Woodward G. Aldridge, Saultsbury, Tenn.
 954,665—Variable Speed Gear. James Archer, Nottingham, England.
 954,612—Tire Heater. David L. Brown, St. Joseph, Mo.
 955,053—Wheel Tire. George W. Crawford, Perth Amboy, N. J., assignor to The Safety Tire Company.
 955,060—Vehicle Hub. Peter A. Eddleman, assignor of one-half to J. B. McConnell, Ingleside, Ga.
 954,859—Vibration Reducer for Shaft Bearings. Louis N. Gooley, Haverhill, Mass.
 954,571—Vehicle Top Rest. Patrick Henry, Dallas, Texas.
 954,817—Singletree Hook. John B. Johnson, Bellingham, Wash.
 954,810—Whiffetree Hook. Charles E. Jones, Windsor, Mo.
 954,522—Spring Wheel. Peter M. Kling, Allegheny, Pa.

- 954,523—Spring Wheel. Peter M. Kling, McKees Rocks, Pa.
 954,526—Shock Absorber. Robert Lepine, New York, N. Y.
 954,711—Vehicle Brake. Wm. J. Wilde, Hazelton, Pa.
 40,639—Design, Automobile Body. Edward J. Gulick, Mishawaka, Ind.
 955,493—Automobile Lamp. Egbert E. Allen, Atlanta, Ga.
 955,494—Vehicle Body. Samuel R. Bailey, assignor to S. R. Bailey & Co., Inc., Amesbury, Mass.
 955,251—Vehicle Axle. Charles Criess, Stroud, Okla.
 955,588—Whip-lock. Jack Erickson, Bingham, Utah.
 955,258—Spring Wheel. Wm. R. Gardner, assignor to Gardner Auto Spring Wheel Company, Los Angeles, Cal.
 955,790—Vehicle Wheel Support. Charles H. Givens, Wawona, Cal.
 955,512—Carriage Top. George W. Hedrick, Dayton, Va.
 955,404—Removable Storm Cab for Vehicles. Wm. A. Hunter, Terre Haute, Ind.
 955,169—Armor for Tires. Wiley W. Jones, Downs, Kansas.
 955,535—Whip-lock and Robe Fastener. Levi L. Noakes, Rogers, Ark.
 955,445—Spring Wheel. Frank P. Prendergast, Dagus Mines, Pa.
 955,692—Pneumatic Spring Suspension for Vehicles. George A. Rhoades, Ulrichsville, Ohio.
 955,440—Vehicle Wheel. John W. Salladay, Milwaukee, Wis., assignor of one-fourth to H. J. Carpenter and one-fourth to C. V. Dixon, Rewey, Iowa.
 955,701—Whip-socket Lock. John R. Schwears, Sunman, Ind.
 955,613—Singletree and Trace Connection. Wm. A. Stinson, Greenwood, Miss.
 955,295—Traction Wheel. Elmer E. Thompson and W. H. Wallace, Chester, Okla.
 955,831—Armor for Tires. Charles E. Titus, Springfield, Mass.
 955,244—Automobile Transmission Gearing. Robert E. Wynn, Brownsburg, assignor of two-sixths to C. D. Rodebaugh, two-sixths to J. H. Kelly, and one-sixth to G. Graves, Indianapolis, Ind.
 Copies of above patents may be obtained for fifteen cents each, by addressing John A. Saul, solicitor of patents, Federal Building, Washington, D. C.

RECENTLY EXPIRED PATENTS OF INTEREST TO THE VEHICLE INDUSTRY.

- Patents Expired July 18, 1910.
 501,525—Vehicle Wheel. John H. Morris, Seward, Neb.
 501,545—Automatic Vehicle Brake. Eli Swartz and Daniel S. Beemer, Scranton, Pa.
 501,588—Wheel Tire. Emile H. Grenet, Paris, France.
 Patents Expired July 25, 1910.
 501,697—Wheel Tire. John T. Smith, Bridgeport, Conn.
 501,992—Vehicle Wheel. David Crowther, Huddersfield, England.
 502,027—Spring Vehicle. Christopher C. Bradley, Syracuse, N. Y.
 Patents Expired August 1, 1910.
 502,318—Vehicle Spring. Herman H. Peiper, St. Louis, Mo.
 502,397—Wagon Jack. Charles Emons, West Troy, N. Y.
 502,406—Vehicle Hub. Henry E. Moebus, Woodstock, Ont., Canada.
 502,576—Brake for Vehicles. Charles E. Newman, Baltimore, Md.
 The above lists of patents, trade marks and designs of interest to our patrons are furnished by Davis & Davis, solicitors of American and foreign patents, Washington, D. C., and St. Paul Building, New York City.

WHAT STORAGE BATTERY WILL DO.

Preliminary reports to the Anderson Carriage Company of Detroit from Thomas A. Edison, who is testing his new storage battery in a Detroit Electric, shows that the car equipped with the battery has traveled from 102 to 131 miles on a single discharge.

Edison is making the tests to find out just what the man may expect who buys an electric equipped with his battery. He selected the Detroit as the electric best fitted mechanically to carry out the test, and platted a number of routes over which the runs are being made. These routes begin and end at the Edison headquarters at West Orange, and carry the car throughout the country and over the hills of New Jersey, across into New York and up through Westchester County.

On one occasion the Detroit made 102 miles before the battery was exhausted; another time the odometer registered 116 miles, and a third time the Edison report shows 131 miles. These distances were each made on a single charge of the battery, and are the more unusual by reason of having been made on country roads.

NEW SIX-CYLINDER AUTOMOBILE MOTOR.

Harry Wainwright, of the Wainwright Engine Works, Connersville, Ind., has designed a six-cylinder gasoline motor for automobiles. The distinctive feature of the invention is the arrangement of the valves in the cylinder heads. Instead of being placed in a straight line across the head, they are replaced in two shorter lines. This is meant to make a more economical use of surface and permits the use of larger valves. The McFarlan Automobile Company of Connersville will use the new motor in its cars.

THE JEWEL CARRIAGE CO.'S PROPOSITION TO CREDITORS.

The committee of the creditors of the Jewel Carriage Company, Carthage, Ohio, is canvassing the creditors on a proposition of settlement. The committee consists of Elmer J. Hess, C. W. Shipley, E. G. Schultz, Fenton Lawson and W.H. Muench.

The proposition to the Creditors' Committee is signed by C. F. Pratt, J. W. McCutchen and A. E. Schafer for the Jewel Company. On claims of general creditors under \$500 the offer is to pay 60 per cent in cash, on claims above \$500 to pay \$300 cash, the balance in automobiles made by the company at the list price of \$1850.

The real estate, appraised at \$115,000, is to be turned over to creditors for \$100,000, each creditor to take a pro rata interest, the same to be arranged through a trust deed for ten years, during which time the carriage company is to use the property and pay \$2,000 rent for 30 months, \$3,000 the next thirty months and \$4,000 thereafter. The company proposes to issue \$100,000 first and second preferred stock, any creditor to have the right to take the entire balance of his claim after the cash payment in first preferred stock, or any creditor is offered the full amount of his claim in first preferred stock at 6 per cent. Holders of preferred stock under such settlement are entitled to two directors out of five.

THE NEW "RUB-FAST."

The Ault & Wiborg Co., of Cincinnati, Ohio, a concern long identified with the trade that had to use much varnish in its finished product, has now concluded to market a vehicle varnish



Plant of Ault & Wiborg Co.

which has been trade-marked as "Rubfast." As its name signifies, it is a rubbing varnish of very quick working and drying quality.

In all varnish there is but one supreme and convincing test of quality, and that is its application at the hands of the painter. This company wants to abide by such test, and invites painters to try the "Rubfast" before passing an opinion.

INCORPORATED.

The Edward F. Alf Company, of Cincinnati, is now in the incorporated class. The business, as usual, will include carriage and automobile trimmings, and as the company has superior mill connections, and carries at all times a large stock, it becomes an important trade factor. Mr. Henry C. Jay, formerly a part of the Nelson-Alf Co., is vice-president of the new company.

TORPEDO EFFECT FOR A CHAR-A-BANC.

That torpedo construction is destined to be confined to the realm of the light and swift pleasure car need not for a moment be supposed. Already a British manufacturer has produced a large char-a-banc in which the straight sided and high-door profile of the "battleship" body is faithfully reproduced, though for what purpose, considering the intended use and generally slow speed of the machine, is difficult to say.

ROAD BUILDING RECORD.

This is an account of what Iowa farmers did, taken from Farm Machinery:

Iowa farmers established a world's record for building a road 380 miles long in one hour flat. They accomplished this feat on July 9, and Iowa now has one of the finest roads west of the Mississippi River. Another remarkable thing about the building of the highway is that the 10,000 men who did the work, not a single one of them received a penny for their services, they volunteering them in order to improve their property.

Last winter the question of constructing a road clear across the State was broached, and it speedily became a political matter with both parties favoring it. In March a meeting was held in Des Moines and the preliminary arrangements were made. From then until the first part of July, neighbor vied with neighbor in getting the materials ready to build a highway to extend across the State, from Council Bluffs, on the Missouri, to Davenport, on the Mississippi, a distance of 380 miles. The slogan was "make the road as nearly perfect as is possible with just common dirt."

Every farmer along the way was personally seen by the committees and practically every man agreed to give the one hour that was asked for. Farmers were asked to bring their plows, scrapers and road drags, and an organization equal to those employed in professional railroad building was worked out.

In the weeks preceding the work, all bridges and culverts along the road were repaired and put in first class order that no delay might come to the road builders when once the latter started working.

The result of the organization was shown on July 9. Shortly before 9 o'clock in the morning, farmers began getting out in the road. Hundreds of picks, shovels, plows, scrapers, road drags, grading machines and other implements used for road building were brought out. Every farmer had at least one team of horses with him and many had several. Superintendents and overseers had been appointed, and promptly at the strike of 9 the order was issued to fall to.

And 10,000 determined men fell to. For an hour they continued working with might and main. At 10 o'clock the job was finished.

NOTHING TOO GOOD.

Taxicabs "de luxe" are soon to be the newest thing on Broadway. The new cars are to surpass in luxuriousness any four-wheeled vehicle in the world, not even excluding the state carriages of royalty.

According to the promoters of the new enterprise, the cabs will be mainly constructed of heavy bevel glass so as to show off women's gowns to advantage. The interior will be lighted by electricity with reflectors, so as to throw the occupants into prominence. Thus a woman en route to the theatre or opera cannot only show off the latest Parisian creation in gowns but her jewels as well. The tops of the vehicles will be lined with shirred silk, and the cushions will be made from costly damasks and brocades. The interior decorations will be removable, so that a woman may order the taxicab furnished in colors to suit her gown.

PATENT ON EAGLE WAGON SUSTAINED.

A decision has been handed down by Judge Holland of the United States Circuit Court for the Eastern District of Pennsylvania, holding a patent owned by the Eagle Wagon Company to be valid and infringed upon by the dumping wagon manufactured by the Columbia Wagon Company, of Columbia, Pa. The patent covers a device for raising the doors of a dump wagon and, it is said, that practically all such wagons in use employ a mechanism substantially like the one in controversy.

PULLMAN MOTOR CAR CO.'S MODELS FOR 1911.

The Pullman Motor Company, of York, Pa., in announcing its 1911 models states that it adheres to its policy to effect mechanical changes only when progress in the automobile art demands them. For that reason the changes in the 1911 machines over the 1910 cars are simply in the nature of refinement of details. The three 1911 models are, as in 1910, Models K, O and M.

The Model K, 35-horsepower touring car has been lengthened in wheel base from 112 to 114 inches, giving more leg room for the front seat, and increasing the easy riding qualities of the front seat of the machine. The steering wheel has been improved in appearance on the K-11 by the use of a larger brass housing, and the car can be easily manipulated over the rough roads. The changing of the shape of the bottom pans of the motor, the raising of the headlight bracket and the changing of the door shapes to a more straight line effect, are all refining touches. This car comes in either touring, toy tonneau, roadster or limousine bodies.

The motor has undergone no change, except in the betterment of the running parts, and the incorporation of a few detail features which make for quietness and smoothness of the running qualities. A "T" head type of motor is still continued. The Model K has a four cylinder, four cycle, water cooled motor, the cylinders being cast singly from air-furnace, close-grained French gray iron and bolted together so as to form one water compartment. The water jackets are cast integral, having large flanged openings, by which the cylinders are cast together. Each cylinder casting may be removed independently of the others without disconnecting any piping. The Model K-11 cylinders are bored $4\frac{1}{2}$ inches, with limits of .005 inch be-

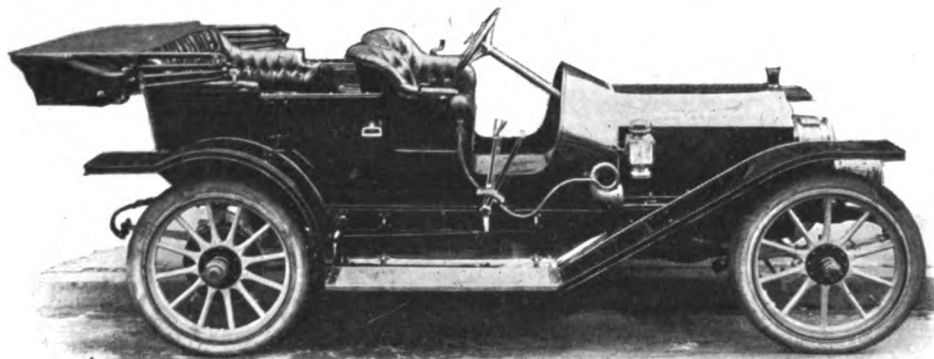

Pullman Model O.

low and above, giving a variation of .001 of an inch. Valves of the Model K-11 are $1\frac{1}{8}$ inches in diameter. The valves have nickel-steel heads, electrically welded to machine steel stems. The valve seats are beveled 45 degrees, and are ground to size, as are also the stems. The valves are adjustable as to timing and clearance by locknuts on top of the square valve lifters.

The pistons, which are of the same material as the cylinders, are ground and tapered from the lower compression ring to the top to allow for differences in expansion due to the heat when in operation. When assembled the pistons and cylinders are hand tapered to insure a perfect fit. The pistons are fitted with three five-sixteenth inch eccentric compression rings above the piston pin, and a series of oil retaining grooves below for distributing the oil around the rings and through the hollow piston pins. The machining measurements, as given on the cylinders, also apply to the pistons. The pistons are ground .003 inch below— $4\frac{1}{2}$ inches up to the first ring above the wrist pin, and from that point to the top they are ground to .012. The wrist pins are fitted to within .00025 inch. The connecting rods are drop

forged of I section, and fitted at the lower ends with Parsons white bronze bearings.

The crank shaft has three main journal bearings and two intermediate bearings running in Parsons white bronze. The bearings are of generous proportions; the front bearing is $1\ 9\text{-}16 \times 2\frac{3}{4}$ inches long, the rear bearing is $1\frac{5}{8} \times 3\frac{5}{8}$ inches long, the three centre bearings $1\ 9\text{-}16$ inches diameter by $1\frac{1}{8}$ inches long. The crank shaft is drop forged from a solid billet of alloy steel, and is offset from the centre of the cylinders to reduce the angularity of the connecting rods on the power stroke, and the side



Pullman Model K.

thrust and friction of the pistons against the cylinder walls. The half time gears, together with the magneto and pump driving gear and the crank shaft gear, are enclosed in an oil-tight casing, which is integral with the crankcase proper and entirely separate from the crank compartments. The crank case is made of aluminum alloy, and is in two parts, the upper portion containing the crankshaft bearings and the lower portion the lubricating system. The lubricating system works on the constant level circulating principle, the reservoir in the extreme bottom holding some two gallons of oil, which is circulated by means of an eccentric pump of the vane type to the several bearings, and from them it flows to the connecting rod splash bowls, which are gauged to maintain a certain amount of oil, the overflow returning to the well or reservoir.

The centrifugal water pump and magneto are located on the left hand side of the motor, and driven by a single shaft from the exhaust cam shaft gear, Oldham couplings being provided to allow of the removal of either without disturbing the other. The carburetor is located on the right hand side of the motor, and well forward. Back of the carburetor, and on the rear crank hanger arm, is located the oil gauge for determining the amount of oil in the reservoir, and a tube which serves the double purpose of oil filling tube and crankcase compression relief tube.

The cone clutch is faced with chrome leather fitted with cork inserts, and is pivoted on the rear end of the crankshaft. Between the clutch and transmission are fitted double universal joints of the removable, square block type. The selective type of transmission is housed in an aluminum casing carried on the sub-frame, and affords three forward speeds and one reverse speed. The direct drive and countershafts are carried on Hess-Bright annular ball bearings. The gears are 6 pitch, wide faced, and turned from forged bars of chrome vanadium, after which they are hardened and oil treated. The gear shafts are of the same material. The propeller shaft is equipped with two double universal joints of the block and trunnion type. The rear axle has a pressed steel housing, and is of the full floating type, with the differential carried on Timken roller bearings. Internal expanding and external contracting brakes working through

equalizers and operated in the usual method act on the rear wheel brake drums.

The front axle is the conventional I-beam drop forging, the wheels being carried on Timken roller bearings, which are also in the rear axle just inside the wheels. Grease cups are supplied at every moving joint or bearing on the chassis.

The frame is of pressed nickel steel, with sub, frame, on which is carried the power system. The steering gear is of the worm and sector irreversible type. The worm is fitted with ball thrust bearings for adjustment. The spark and throttle control levers are carried on a stationary quadrant above the 18-inch mahogany steering wheel. The front springs are semi-elliptic, 40½ inches long and 2 inches wide. The rear springs are semi-elliptic, 51 inches long and 2 inches wide. The fenders are rakish, made from pressed steel, with the running boards enclosed. Dashes are mahogany, brass bound.

The bodies are of wood and aluminum, upholstered in hand buffed leather. The gasoline tank is located underneath the front seat. The wheel base is 114 inches, with 34x4 inch tires all around. Each car comes equipped with two gas headlights, gas generator, two oil side lamps, an oil tail lamp, horn, tools, coat and foot rails.

The Model O is regularly fitted with a four passenger, detach-

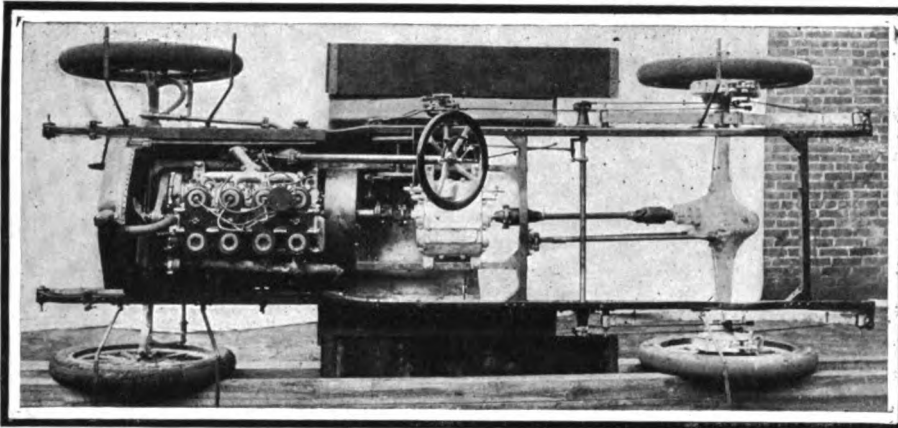

Plan View of Pullman Chassis, Model O.

able toy tonneau body, touring, surrey, double bucket and regulation roadster bodies, the price being \$1,650 with any of these bodies, and \$1,600 with two passenger or runabout body.

This car has a four cylinder, four cycle motor of 4 1-32 inch bore and 5 inch stroke. The clutch is of the cone type, and is faced with chrome leather, fitted with spring inserts to enable it to engage gradually. The crankshaft has three journal bearings running in Parsons white bronze bushings. The sizes of these bearings are as follows: Front, 1½x3 5-16 inch; intermediate, 1½x2¾ inch; rear, 1 9-16x4 inch. The rear axle has a pressed steel housing, and is the standard full floating type fitted with ball bearings throughout. The brakes are of very liberal size, of the internal and external types, working through equalizers operated in the usual manner on the brake wheel drum.

The bodies are made of wood and aluminum reinforced with steel, and are upholstered in hand buffed leather. The springs are semi-elliptic in front, 38 inches in length, and three-quarter elliptic in the rear, 40½ inches in length. The car weighs 2,300 pounds, and is claimed to be very easy on tires.

The equipment of the Model O includes gas headlights, gas generator, two oil side lamps and an oil tail lamp, horn and tools. The standard color is "Pullman red." Blue with straw wheels or black with straw wheels are optional colors.

The Model M., a \$3,500 car, will be ready for delivery early in the fall. It will have a wheel base of 127 inches, and will weigh approximately 3,500 pounds. Either five or seven passenger touring bodies will be fitted to this 50-horsepower chassis, as well as a limousine of exceptionally luxurious construction.

BODY POSSIBILITIES IN METAL.

Perhaps no industry has benefitted more from the advancement of the art of sheet metal working than the automobile business. At the same time, it may not be putting it too strongly to suggest that the average motor car manufacturer even yet is neglecting a few golden opportunities in this direction. The most natural thought in this connection when the application of rolled and pressed metal in other industries is considered is that the steel body has not begun to receive its due, despite the fact that not a few have been and are being produced.

It is also true that many of the bodies so produced and others on which stamped panels or other parts are used do not equal in appearance or serviceability the results obtained by the older and laborious process of fashioning the wooden body. Many authorities are of the opinion that as good results never can be obtained with metal as with wood, but it must be admitted that there is associated with the delicate and artistic craft of the cabinet maker and fine carriage builder a certain affection which no other material inspires. That this is largely a matter of association, however, is a conclusion based on the notion that true art can find expression in any medium.

What has been done in the application of metal work to the interior trim of modern fireproof buildings, says the Motor World, affords an example in point. The all steel railway cars which rapidly are finding their way into use furnish an even better illustration of what may be done in automobile building. In many instances the designer still is hampered by the traditional inclination to imitate as closely as possible the effects and even the appearance of the older materials. In a few instances, however, results have been obtained which show that satisfactory and even artistic as well as serviceable effects can be obtained with all metal finishes.

In its application to the mechanism of the car, sheet metal is receiving constant and appreciative attention; its use in body work would seem to be susceptible to more extended use. It may be going a long way into the future to foresee the all-metal limousine or cab, or the convertible body of all-metal construction which may be made either open or closed at will. The advocates of the wood may urge that to obtain pleasing and permanent results with metal is a practical impossibility, but it must be remembered that the effects now obtained with wood are derived from centuries of experience with the material and many decades of experience in the construction of coachwork. What an equivalent period of development with modern methods will show it is not difficult to predict.

MORE GUAYULE RUBBER.

Writing from Ciudad Porfirio Oiaz, Consul Luther T. Ellsworth says, according to a recent statement given out by the guayule rubber manufacturers, there are guayule rubber plants to the value of about \$65,000,000 in the Mexican state of Coahuila; that during the first four months of this year the manufactures extracted from that plant 6,286,678 pounds of rubber, valued at \$6,000,000 United States currency; that the present production capacity of rubber of the guayule shrubs in this state is about 300 tons of rubber daily, and that production can be increased by systematic cultivation of the guayule shrub which has heretofore grown wild only and been destroyed in gathering. It is alleged that the vast estates of the Madero family in this State have on them many million dollars' worth of the guayule shrub.

Ash is one of our easiest native woods to dry, and when dry does very little swelling and shrinking. Consequently it is a good wood to use where it is desired to guard against coming and going with the weather.

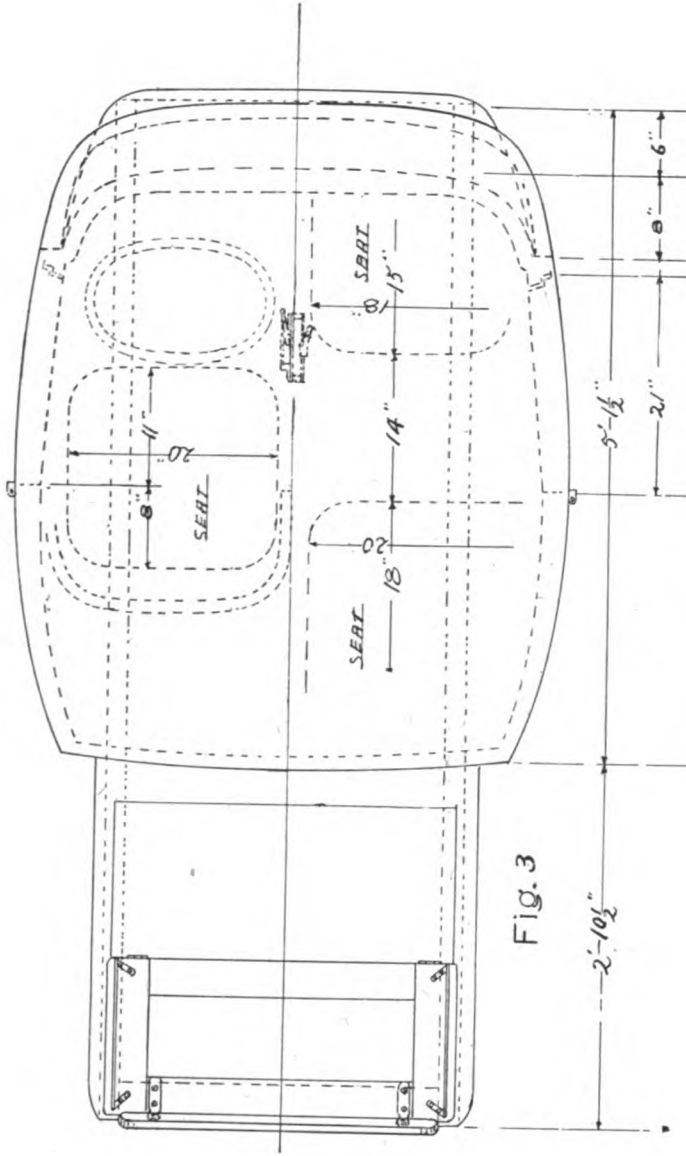

Fig. 3

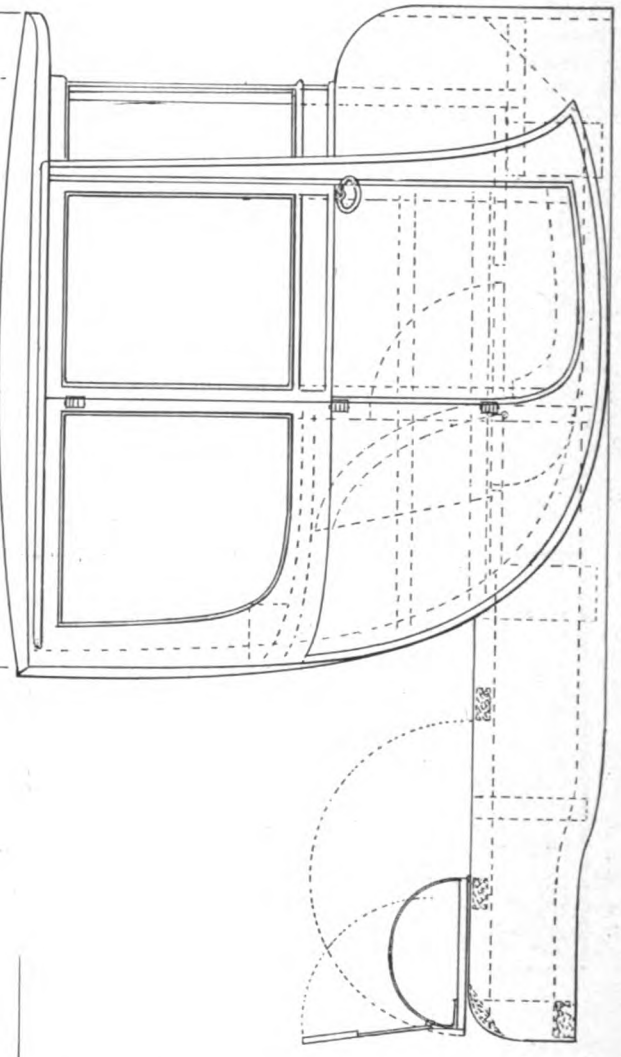

Fig. 2

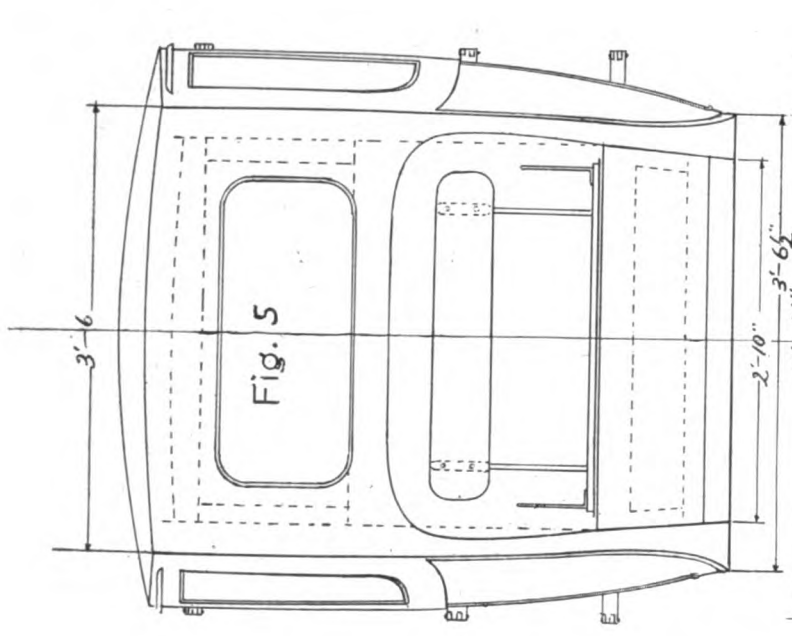

Fig. 5

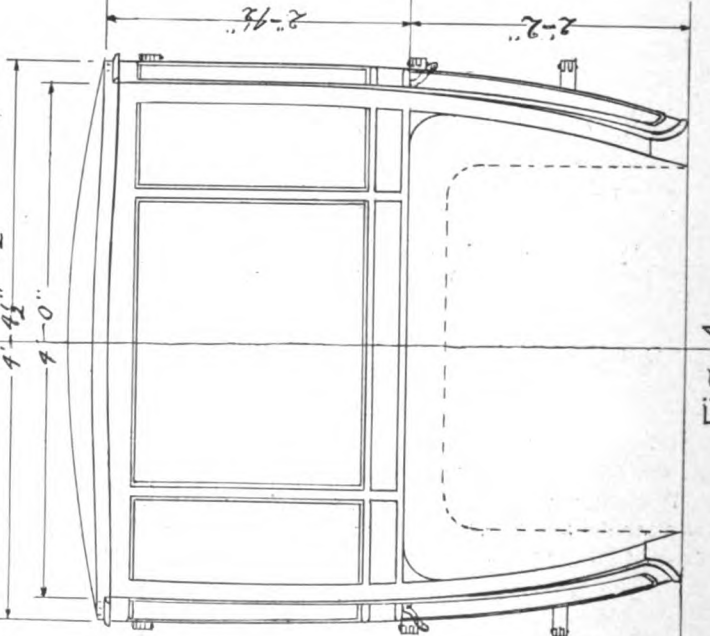
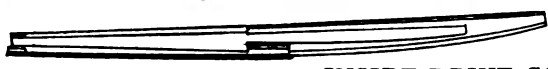

Fig. 4



INSIDE DRIVE COUPE, (Described on Opposite Page.)

INSIDE DRIVE COUPE MOUNTED ON A LEFT SIDE DRIVE CHASSIS.

Fig 1 shows an inside drive coupe with round extension front and seat room inside for three persons as well as ample carrying space at the rear with an emergency seat for the mechanician.

The special features of this design are ample glass to permit the operator to see from the front, sides and rear. The front glass parted to give the visor shield when it is raining or snowing; three seatings inside so that when the car is used by a lady there is place for a companion in addition to the operator. The operators seat tilts up so that access can be obtained from either side. Left side drive so that the passengers mount from the sidewalk. Room at the rear of the operators seat for bundles or a suit case, ample carrying space for gasoline tank, batteries and luggage without obstructing the inside of the body seating space. This body is mounted on a 116-inch wheel base chassis.

Description of the construction: Figures 2, 3, 4 and 5, show the side, top, front and back views. The body is made with ash framing and white wood panels. All mouldings are worked on

cushion part folds against it. The seats on the right side are stationary. The body should be trimmed with cloth and the emergency seat at the rear with leather. The quarter and door lights are made to drop and the rear and front corner lights are stationary. The center front light is divided 16 inches down from the under side of the roof, the lower part is stationary and the upper part is hinged at the top and swings outward to form a shield or visor and give a clear vision when the weather is bad. Side arms support this glass in position forward. The emergency seat is made to fold or swing as indicated by dotted lines and forms a cover for the well of the carrying compartment. The extension roof in front of the top rail is painted on the under side and there are no bows ahead of the top rail. The glass frames are made of mahogany and finished in the natural color. These frames are $\frac{5}{8}$ -inch thick by $1\frac{3}{8}$ to show clear of the groove.

MAY MULCT WINDSHIELD MAKERS

Planning to collect a royalty of \$1 on every windshield of the "zigzag" or inclined section type that has been made in this country or that will be made for some years to come, a patent

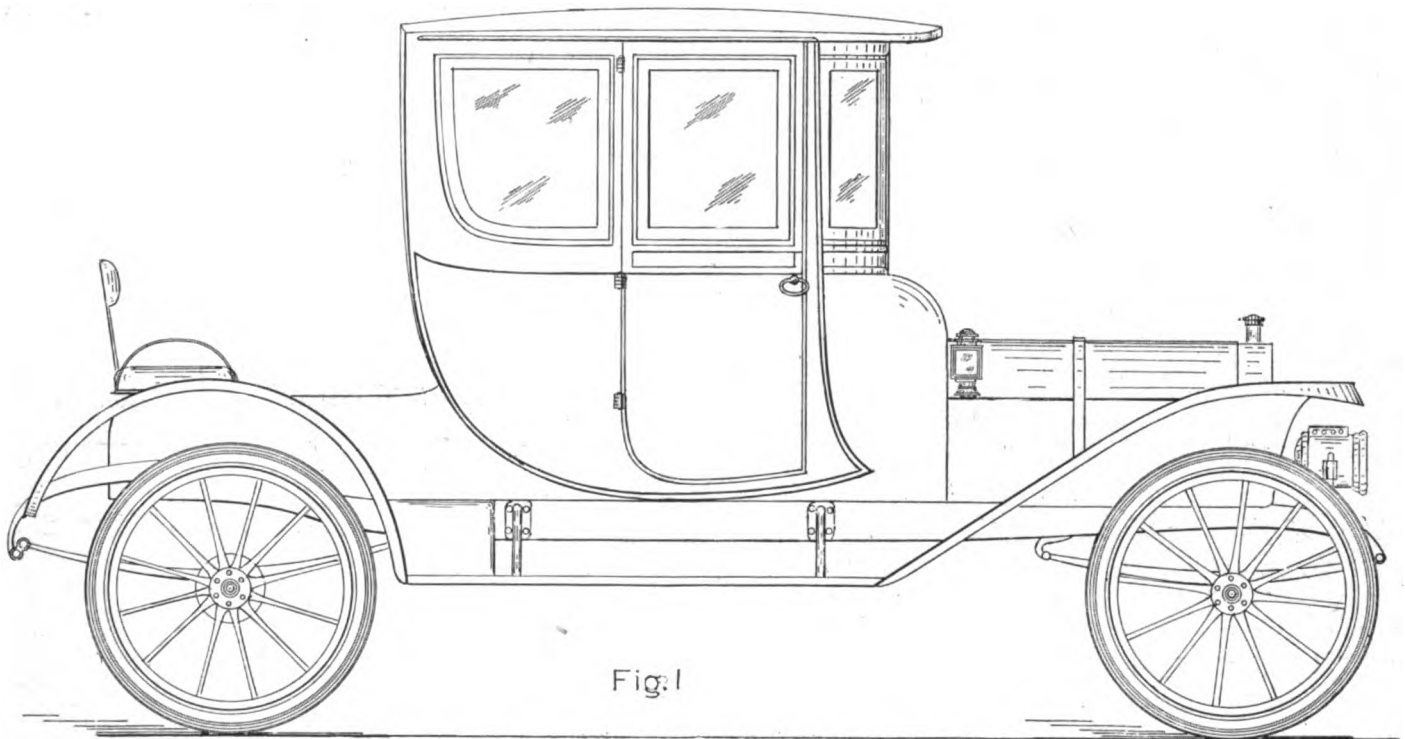

solid and the tee moulding at the front of the door is made to run up the entire length of the pillar; this is done to overcome the bad fault of the wood moulding breaking when it projects beyond the pillar to cover the door opening.

The sizes of the framing are drawn to the scale indicated and the most important dimensions are indicated by figures. The rounded panel at the front below the belt is made from 15-gauge aluminum shee and is shaped by beating. This metal is fastened under the middle bar and the inside of the coupe pillar and is carried over the front of the wood dashboard and fastened so that the engine hood will cover the screws. The seats' inside are 9 inches from the top of the board to the top of the floor and 46 inches from the top of the seat board to the under side of the bow; this latter dimension is 1 inch less than the customary height used in a limousine. The operaor's seat is hinged to swing up, the centre of the hinge being about 8 inches from the back end; this will cause the seat to stay put when it is raised, and gives an unobstructed entrance the full width of the door from the left side. This seat back is stationary and the

holding concern known as the Stahlbrodt Co. has been incorporated in Rochester, N. Y. The company has acquired what is claimed is a "basic" patent on windshields of this type, the patent being that granted to an English army officer, Major Henri S. Samuels, February 18, 1908. The company's only object is to establish its patent claim and collect royalties, although it later may engage in the windshield manufacture. The stockholders are Lawrence Stahlbrodt, Allen M. Brewer and Homer Reichenbach.

ADOPTING UNIFORM NAMES.

Pursuant to the policy of the United States Motor Company in adopting uniform names for its twenty-eight branch houses, the name of the Maxwell-Briscoe Indianapolis Company was changed to United Motor Indianapolis Company. The name United Motor will be used in each city where branch houses are located, with the addition of the name of the city, thus making the names practically uniform throughout the United States.

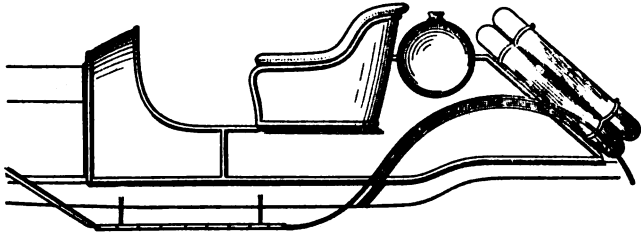

FIG. 1.

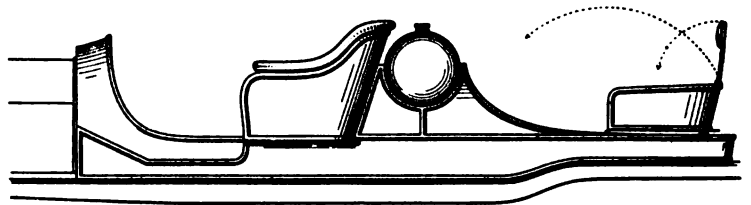

FIG. 2.

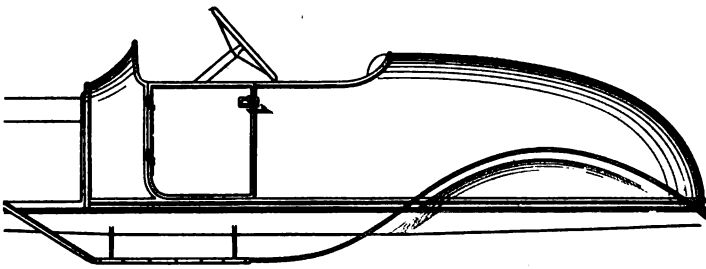

FIG. 3.

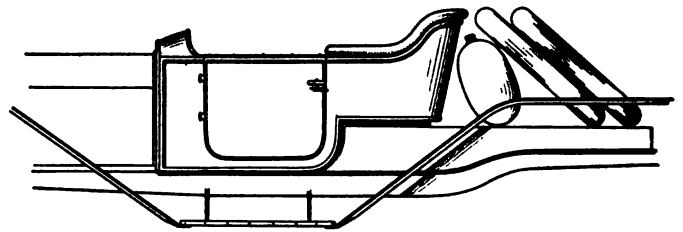

FIG. 4.

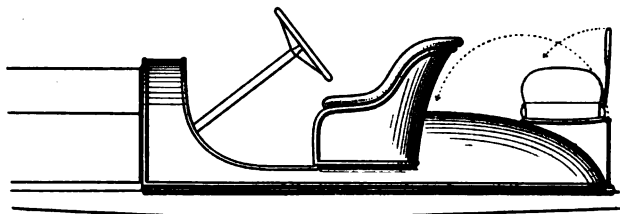

FIG. 5.

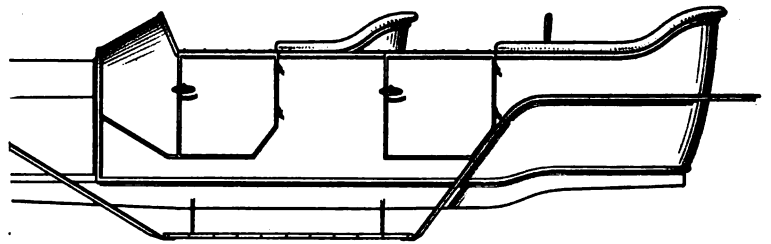

FIG. 6.

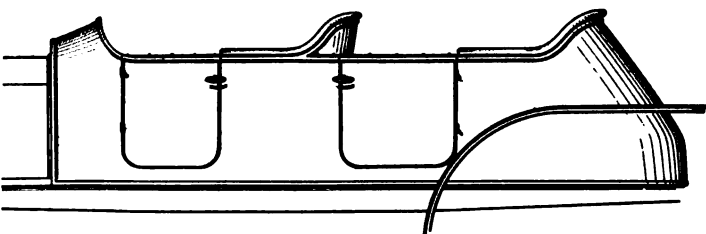

FIG. 7.

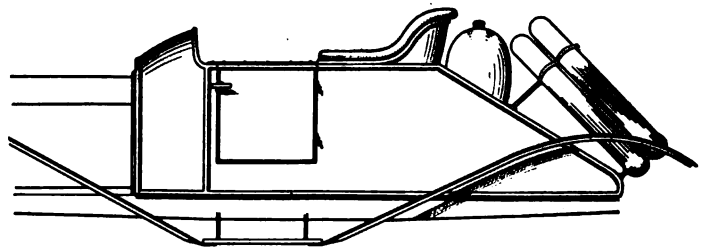

FIG. 8.

Various Designs of Motor Car Bodies
(Described on Opposite Page.)

PREVAILING DESIGNS OF THE GUNBOAT, DUST-PROOF AND TORPEDO-STERN TYPE OF BODY.

(Illustrated on Opposite Page.)

We display, on the opposite page, a variety of bodies familiar to New Yorkers at the present time and they include the gunboat, dust-proof and torpedo type and their kin.

The first illustration, Fig. 1, represents a runabout style intended to carry two persons, with ample accommodations in the body for luggage, etc., with perfect means of locating the gasoline tank and extra tires. Access to the body is obtained by a lid on the deck panel, inside of the tires.

Fig. 2 illustrates another type which is meeting with much favor at the present time. It is dissimilar to Fig 1 in the fact that it is provided with an extra seat, half oval in shape, to carry one person. The seat is made to fold down into the body, leaving a platform that can be utilized for carrying extra tires, or for other purposes. That section of the body supporting the gasoline tank is arched across at the rear, forming a hood.

Fig. 3 shows the Winton torpedo body with side doors. This body is designed to carry two persons and is the masterpiece of the metalworker's art as applied to automobile body construction.

Fig. 4 is another design of enclosed runabout body with a platform extending back of seat to accommodate the gasoline tank and tires.

Fig. 5 represents a torpedo body with an auxiliary seat which folds forward fitting neatly in an aperture in deck of torpedo end and when in use is supported by two rods that are detached and placed in body. The seat is built very close to the floor, an innovation which is apparently increasing in popularity among automobile riders. The reason for placing the seat low is that it insures greater comfort when taking long drives than when the rider is seated high.

Fig. 6 presents the design of the original dust-proof car as made by the Lozier people, the elimination of recesses and projections disposing of any means of accumulating dust. This body is very similar to the gunboat body presented in Fig. 7, the only radical difference being in the elongated back end which is designed to throw off the dust arising from the rear of the car and usually lodging upon the passengers of the rear seat.

Fig. 8 shows another enclosed runabout body deviating from those preceding. Here the body extends forward to the line of door with the back of seat built upon it. The gasoline tank is let into the deck of body. Fixtures for carrying two tires are built to the deck panel.

TIRE PRICES TO BE TESTED IN COURTS.

The question why the price of rubber tires and other manufactured goods has been advanced, in face of the fact that the crude rubber market is a declining one under the accumulation of stocks and heavy available import supplies, is likely to have an interesting answer in an anti-trust law suit now pending. The conduct of the tire business in its various phases during the last dozen years is to be made the subject of investigation in the New York courts on the complaint of a dealer who asserts that he has been blacklisted by the combination or association practically controlling despotically the manufacture and sale of tires for automobiles.

This dealer, Leon D. Kaufman, president of the Moto-Bloc Import Company, of 1875 Broadway, New York City, a corporation organized under the laws of the State of New York, declares that owing to the refusal of the combination to sell to his company automobile tires, as formerly, at dealers' prices, the company is in danger of being ruined. It is impossible, he adds, for his company to purchase such articles at wholesale prices except from the manufacturers or their agencies in New York in such a way as to sell them at a profit to themselves and to compete with other dealers in such articles who are charged a

lesser price for such goods by the companies in the combination.

The case when it comes on promises to be a test one, and will be followed by dealers all over the country. Incidentally it will shed light on the growth of what is known as the "Law of Unfair Competition" which has grown up in this country as well as in other industrial countries in Europe and Japan during the last ten or fifteen years, by appeal to which independent dealers may find a remedy from the monopolistic practices of trust combinations pursuing unfair methods in driving competitors from the field of trade.

The first stages of the proceedings have already developed some special features of interest both from the commercial and legal aspect.

The case first appeared in New York courts on June 27, when Justice Giegerich made an order that Lee W. Bennett and Joseph M. Gilbert, "expected parties to an action about to be brought under the code of civil procedure," should be examined and their depositions taken by a referee relative to the allegations made in the affidavit of Leon D. Kaufman. Bennett and Gilbert were also ordered to produce all books, contracts, agreements, articles of association and other papers.

The application for each motion is somewhat unusual, but the right to its use dates from the old code of procedure and is resorted to in cases where there is a difficulty in the plaintiff obtaining evidence within the statute of limitations which he has reason to believe exists or because of the secret nature of the injury from which he has reason to believe he suffers.

In his affidavit Kaufman, as president of the Moto-Bloc Import Company, swore that the company intended to bring action against the following proposed defendants: The Dealers' Protective Association, transacting business at 25 West 42d street, New York City; Lee W. Bennett, Joseph M. Gilbert, the Continental Caoutchouc Co., a New York corporation; the Diamond Rubber Company of Ohio; the Fisk Rubber Co., of Maryland; the B. F. Goodrich Co., of Ohio; the G. & J. Tire Co., of New Jersey; the Hartford Rubber Works Co., of Connecticut; Morgan & Wright, of Michigan; and the Fisk Rubber Co., Morgan & Wright and B. F. Goodrich companies of New York.

THE NEW TIRE FACTORY AT RACINE.

Good progress is being made in the construction of the factory of the recently organized Kelly-Racine Rubber Co., at Racine, Wis. It was expected that the installation of machinery would be begun by September 1. The plant now under construction has a frontage of 298 feet, with two wings, each extending back 251 feet, the building being three stories and basement. A building 150x50 feet has been provided for the electric power plant; no steam power will be used. The product is to be bicycle, motorcycle and automobile tires, with the accessories usual in this branch.

THE MANY GOODRICH COMPANIES.

The B. F. Goodrich Co., Akron, O., in keeping with the modern practice of incorporating in different states in order to benefit from the most liberal provision of the laws of each, now have a charter in three states besides Ohio. The list includes The B. F. Goodrich Co. of New York, The B. F. Goodrich Co. of Michigan, and The B. F. Goodrich Co. of Texas. Mention may also be made of The B. F. Goodrich Co., Limited, in England. A report from Paris is that a concern to be known as the Societe Francaise B. F. Goodrich, being a branch of the American house of the same name, is in course of organization.

SALE OF FABRIKOID COMPANY.

The Fabrikoid Company, manufacturers of artificial leathers, has been sold to the E. I. du Pont de Nemours Powder Co., Wilmington, Del. "Jack" Rodgers, salesmanager, has been retained by the new owners as salesmanager of the artificial leather department.

ANNOUNCEMENT FOR FALL TERM OF TECHNICAL SCHOOL.

The classes in carriage and automobile drafting and construction, carried on under the auspices of the Carriage Builders' National Association, will open on September 27, 1910, at 20 West 44th Street, New York City. Autumn term will close at Christmas. The winter term will open the first Monday after New Year's Day and close April 10, 1911.

The object is to teach men to design vehicles, and to make working drawings and fashion plates of the the same, and only those men employed in carriage, wagon or automobile building, or some of the accessory trades, are admitted to its privileges.

Requirements for admission to the day or evening classes are: The applicant must be engaged in the manufacture of pleasure or business vehicles, and be 16 years of age or over; he must



Professor Andrew F. Johnson.

be able to speak, read and write English, to write a fairly good business letter, and have a knowledge of arithmetic, sufficient to solve problems in proportion, and also in square and cube root. Some knowledge of geometry is also desirable, but it is not required on entering. Examinations for admission will take place the two weeks preceding the opening of the term; or at such time as may be arranged, to accommodate distant pupils. These examinations will be conducted by the instructor, and will be held at the school rooms. Examinations will be both written and oral.

The day class is to accommodate pupils who wish to devote their whole time to the study of carriage drafting. This class will meet each week day, except Saturday, during the term. Hours from 9:30 a. m. to 4:30 p. m. Instruction is free.

The evening classes will meet on Monday, Wednesday, and Friday, from 7:30 to 9:30 o'clock. Instruction is free.

At the close of the term "Certificates of Graduation" will be given to such pupils of the day and evening classes as pass the necessary examinations.

Examinations will take place in the school rooms each year at the close of the winter term, and will be conducted by the Board of Trustees. Graduates are in demand and many are holding good positions in the leading carriage and automobile factories.

Instruction will be given by correspondence to the employes of carriage, wagon and automobile builders and members of the

accessory trades at their homes by means of the so-called "Chautauqua System."

This system consists in giving instruction to out-of-town pupils through the mail by lesson paper on making free-hand, geometrical, scale and working drawings, each paper calling for responses in the form of hand drawings or written replies, which are afterward examined and corrected by the instructor, Mr. Andrew F. Johnson.

Three terms are required in order to complete the full course of correspondence lessons, which are 83 in number.

All employes of manufacturers of carriages, wagons and automobiles, and the trade accessory thereto, doing business within the United States and Canada are eligible to membership in these classes of "corresponding pupils," the only conditions of entrance being: first, a letter of recommendation from the employer; and, second, the remittance in advance, by postoffice money order, of \$5.00, which will cover all fees for instruction during one term.

For details as to courses of study in the Technical School for Carriage Draftsmen and Mechanics, address Andrew F. Johnson, 20 West 44th street, New York City.

PREPARING FOR GARDEN SHOW.

Preparations for the coming eleventh annual automobile show at Madison Square Garden next January were discussed and in large measure perfected at a meeting of the board of managers of the A. L. A. M. in New York City recently.

The business transacted included drawing for space on the main floor and in exhibition hall and the balconies. The floor space will be materially increased through rebuilding to a large extent the interior of the main hall.

The show will be divided into two parts, one devoted to passenger vehicles and the other to freight or commercial cars. The first section will hold forth from January 7 to January 14 and the second will occupy the following week.

The first to draw for space was the Buick, followed by the Overland, E-M-F, Cadillac, Packard, Maxwell, Chalmers, Reo and Pierce-Arrow. The other cars which will occupy space on the main floor are as follows: Stearns, Thomas, Olds, Franklin, Dayton, Oakland, Lozier, Elmore, Winton, Locomobile, Hudson, Mitchell, Stevens-Duryea and Peerless.

Cars in the exhibition hall and balconies will include the following makes: Amplex, Moon, Mercer, Corbin, Bartholomew, Nordyke & Marmon, Knox, American, Matheson, National, Selden, Buckeye, Moline, Premier, Autocar, Columbia, Alco, Studebaker, Waltham, Inter-State, Ohio, Palmer & Singer, KisselKar, Hol-Tan, Chadwick, Speedwell, Regal, McIntyre, Marquette, Acme, Pierce-Racine, Flandrau, Hupmobile, Midland, Brewster, Courier, Simplex, Atlas, Dorris and Cartercar.

The show committee, which consists of Col. George Pope, chairman; Charles Clifton, Alfred Reeves and M. L. Downs, has devised an elaborate plan of decoration.

It was announced that a meeting will be held in the near future to allot space to accessory dealers and exhibitors of commercial or freight carrying cars, electric vehicles and motorcycles, which will comprise section two of the show.

The Kissel Motor Car Company, of Hartford, Wis., was granted a license under the Selden patent at this session.

MILLER BROS. REORGANIZE.

Miller Bros., Inc., Amesbury, Mass., have reorganized, with augmented capital, which will better enable them to handle their largely increased business.

FRENCH RIGHTS TO TWOMBLY PATENTS SOLD

W. Irving Twombly, of the Twombly Motors Company, has received a cable from Paris announcing the sale of the French patent rights of the Twombly Power Company to Bernard Maimon, the proprietor of Le Matin, of Paris, France.

INCREASE YOUR BUGGY SALES.

One of the best talking points on the sale of buggies is to have them equipped with Cately's Buggy Top Springs and Levers. Just a pull on the inside levers and the top is lowered—a gentle start and the top is up, and both operations are made without effort or inconvenience. This device will prevent broken bows and rattling joints as well.

Customers are always interested in the Cately device and this interest easily becomes desire and a decision to purchase the buggy so equipped. Many manufacturers have adopted the ar-



angement and are furnishing it with their regular vehicles; other are furnishing them when customers so specify.

The Cately springs and levers are made by Cately & Ettling, Cortland, N. Y., who also manufacture standard third seats, camp stools and auto chairs. A catalogue issue by them will be gladly sent to any address.

At the exhibition in connection with the C. B. N. A. convention, Cincinnati, Ohio, Cately & Ettling will have an exhibit. This concern has been a member of the C. B. N. A. for many years, and the firm has many friends in the vehicle builders' big organization.

CONVENTION DATES.

The following associations have announced the dates and locations of their annual conventions:

National Federation of Retail Implement and Vehicle Dealers' Associations, Chicago, October 11, 12 and 13.

Tri-State Vehicle and Implement Dealers' Association, Cincinnati, O., October 25, 26 and 27.

Michigan Retail Implement and Vehicle Dealers' Association, Jackson, Mich., November 8, 9 and 10.

Virginia and North Carolina Retail Implement, Machinery and Vehicle Dealers' Association, Norfolk, Va., Nov. 16 and 17.

Iowa Implement Dealers' Association, Des Moines, Iowa, November 29, 30, December 1 and 2.

Illinois Retail Implement and Vehicle Dealers' Association, Peoria, Ill., Dec. 6, 7 and 8.

Retail Implement Dealers' Association of South Dakota, Southwestern Minnesota and Northwestern Iowa, Sioux Falls, S. D., December 6, 7 and 8.

Wisconsin Retail Implement and Vehicle Dealers' Association, Milwaukee, December 13, 14 and 15.

Western Retail Implement and Vehicle Dealers' Association, Kansas City, Mo., January 17, 18 and 19, 1911.

Pacific Northwest Hardware and Implement Association, Spokane, Wash., January 18, 19 and 20, 1911.

Retail Dealers' Hardware and Implement Association of Texas, Houston, Tex., February 14, 15 and 16, 1911.

The Colorado Retail Implement Dealers' Association will meet in Denver, probably the last week in January. The exact dates have not been selected.

T. A. GRIFFIN WRITES AN OPEN LETTER.

In the open letter addressed to the business men of the country by T. A. Griffin, president of the Griffin Wheel company, of Chicago, the author speaks of the relation of railroad rates to the business man. His argument states that no matter how objectionable an advance in freight rates would be to business men personally, they must recognize that an improvement in general business is dependent on a betterment of operating and financial conditions of the railroads.

That the operating results are unsatisfactory is shown, he says, by the latest Interstate Commerce Commission reports, which state that for the nine months ended April 1, 1910, eleven railroad systems, all west of and north of a line drawn from Chicago to St. Louis, compared with the same roads for the same period in the previous year, had their gross earnings increased about \$50,000,000, while their net earnings show a decrease of \$3,500,000, and for the month of March on the same comparison, they show an increase of \$7,000,000 in gross and a decrease of \$965,000 in net earnings. Attention is also called to the fact that the wage increases, except a small amount, were not in force during the period, which will greatly increase the operating cost. Increases in taxes are also shown.

During the past three years of poor business, continues Mr. Griffin's letter, railroad expenditures were necessarily at their lowest, and, in consequence, their motive power, equipment and tracks now demand a greater proportion of operating expenses. It also urges the necessity of the shipper recognizing the importance of the railroads keeping their equipment and property in shape to fully handle the business offered, and cites the cost to the shipper of paralyzed traffic conditions caused by inefficient equipment as compared to a reasonable advance in freight rates. Mr. Griffin also takes up the relation of railroad rates to the investor, and makes an appeal to business men to study the conditions carefully.

ANOTHER GOODRICH BUILDING.

The B. F. Goodrich Co. will shortly finish another reinforced concrete and brick building, three stories high, with a frontage of 158½ feet, and extending back 260 feet, so planned as to admit of two floors being added later. The ground floor will accommodate the maintenance department and the garage for tire testing cars, the company's trucks, and the automobiles owned by officials and employes. The second floor will house the machine shop, where the finer grades of molds will be made, and the carpenter shop and paint shop. The third floor will be devoted to rubber manufacturing.

AKRON'S LATEST RUBBER COMPANY.

The Portage Rubber Co., organized by business men of Akron, Ohio, with an authorized capitalization of \$1,000,000, to manufacture solid and pneumatic tires and a general line of rubber goods, capital stock is one-half each in preferred and ordinary shares. The directors of the new company are Will Christy, John W. Miller, James Christy, W. S. Long, Dayton A. Doyle, John Kerch, Arthur S. Mottinger, all of Akron, and Hayward H. Kendall, of Cleveland, Ohio. The new company plans to take over the plant and business of the Union Rubber Co., of Barberton, Ohio, with a view to doubling soon the reclaiming plant of the latter.

STUDEBAKER COMPANY OF NEW YORK WILL MOVE.

The New York building now occupied by the Studebaker Company at 48th street and Broadway and Seventh avenue, is to be turned into a hotel. The company will probably move to a new building in the vicinity of Fifty-second street and Seventh avenue.

AN INTERESTING SALES CHART.

One of the most interesting tabulations in connection with the automobile industry, has just been made public by the Association of Licensed Automobile Manufacturers. It is a careful compilation of figures recorded with the A. L. A. M. for each year since 1903 and gives the average price of automobiles for each year since that time.

The chart shows an increase in the price of motor cars from 1903 until 1907, but since that time the average price has gradually declined. This is not the result of any radical reduction in the price of motor cars, but is brought about by the great increase in the manufacture and sale of machines selling at \$1,500 or less. In the early days, a car at less than \$2,000 was rare, while now the greatest volume of business and the greatest number of machines are under that figure.

The sales recorded by makers licensed under the Selden patent are for American gasoline automobiles only. By comparison, however, the sales of steam and electric vehicles are small.

The figures show that the trend in manufacturing has been to each year give more for the same list price, than to make any great cut in the selling figure. There has been a tremendous increase in the making of what are termed the moderate priced cars and a normal and healthy increase in the number of the higher prices machines produced.

From \$1137.37 as the average price for cars in 1903, the average ran up to \$2137.56 in 1907, since which time it has decreased until the first six months of 1910 shows \$1545.93 as the average retail list price of cars.

The following comparative table indicates the average price for each year for the sale of gasoline automobiles licensed under the Selden patent (which is probably 85 per cent of the industry), including the first six months of 1910.

| | | | |
|-----------------|----------------|-------|-----------|
| 1903 | Average price, | | \$1133.37 |
| 1904 | " | " | 1351.45 |
| 1905 | " | " | 1609.79 |
| 1906 | " | " | 1853.93 |
| 1907 | " | " | 2137.56 |
| 1908 | " | " | 1926.94 |
| 1909 | " | " | 1719.93 |
| 1910, to July 1 | | | 1545.93 |

REDUCED RATES TO TRI-STATE MEETING.

Reduced railroad rates have been secured from many points for the Tri-State Vehicle Exhibition at Cincinnati, which occurs the week of October 24. From territory south of Ohio and east of the Mississippi River (3-cent territory) greatly reduced rates have been granted. Practically half fare will prevail from points in Alabama, Georgia, Kentucky, Louisiana, Mississippi, Tennessee and Virginia. The plan provides for the use of ticket form "S." The purchaser buys the reduced rate round trip ticket, which he must sign in the presence of the ticket agent. This ticket must be stamped by an authorized agent at Cincinnati upon the date of return. No certificates are needed or receipts taken as heretofore. The dealer should not forget that a receipt for fare paid will not secure a reduced return rate. A round trip ticket must be purchased at the home station. It will be well for the dealers in the states named, who intend to take advantage of these rates, to notify their station agents a few days in advance so that if the proper form of ticket is not on hand it may be secured. Dealers who find that the reduced rate is not available from their station may obtain information as to the nearest point to which the reduced rates apply by writing to P. T. Rathbun, secretary, Springfield, O. The dates of sale are October 22, 23 and 24; return limit October 31. In nearly all other territory the 2-cent rate prevails.

If you have not power within yourself from conscious influx from the Divine Source of all power, where do you expect to find it.

BACK TO INDIANA.

Indianapolis papers report that Gates-Osborn Manufacturing Company, of Marshalltown, Iowa, is preparing to move to the Hoosier capital. Frank E. Gates, the head of the institution, was formerly located in Indianapolis, where he was connect with the Cole Carriage Company. He went to Marshalltown five years ago.

ASSOCIATE MEMBERS C. B. N. A.

Announcement has been made that the annual meeting of the Associate Members of the C. B. N. A. will be held in Convention Hall at Cincinnati, Ohio, Wednesday, September 28, at 2:30 p. m. A full attendance is desired and all members are urged to be present.

DIAMOND FORGING AND MFG. CO.

The Diamond Forging and Mfg. Co. was incorporated early this year and is operating a new plant erected on the North Side, Pittsburg, Pa. It has also acquired the plant and property of the old Pittsburg Tubular Steel Whiffletree Co., and will continue the manufacture and sale of its line. W. D. Henry, president of the National Fire-Proofing Co., is president; D. R. Wilson, for more than eight years with the Crucible Steel Co. of America, Pittsburg, is vice-president and general manager, and David M. Smith is secretary and treasurer.

THE STEINS TO BUILD.

The Stein Double Cushion Tire Co., has made tentative plans for a new factory building, for which ground probably will be broken early in the spring.

Wants

Help and situation wanted advertisements, one cent a word; all other advertisements in this department, 5 cents a word. Initials and figures count as words. Minimum price, 30 cents for each advertisement.

HELP WANTED.

Wanted—Draftsman, by a large western body concern. Man with good ideas of construction and design and familiar with limousine, coupe and touring car work. Good opportunity. Young man preferred. Box 90, The Hub, 24 Murray street, New York, N. Y.

FOR SALE.

For Sale or will lease for terms of five years modern equipped carriage factory in one of the best towns south of the Ohio River. Reason for selling—have other business that requires the proprietor's attention. Address C. B. K., care The Hub, 24 Murray street, New York.

For Sale—Manufacturing plant. New, modern, electrical equipped, ideal location with reference to timber, fuel, labor and shipping facilities. Will take stock in established or new enterprise. If you are contemplating a change of location, or the establishment of a new enterprise, this is an opportunity of a life time. Address The Hickman-Ebbert Co., Owensboro, Ky.

For Sale—Quantity of 24 oz. American broadcloth suitable for taxicab trimming, in three colors, green, blue and maroon, all in No. 1 condition; very cheap. For particulars address George J. Mercer, Room 401, 1777 Broadway, N. Y.

For Sale—Wagon and carriage repair shop in Norwood, Ohio. Owner desires to go south. Address 2110 Monroe avenue, Norwood, Ohio.

For Sale—Seventy dozen 16-inch H rasps, half file, at \$3.50 per dozen while they last. A bargain. Address F.J. Connelly, Baldwin Place, Westchester County, N. Y.

For Sale—A well established buggy and wagon business. Box 192, Gainesville, Fla.

PATENTS.

Patents—H. W. T. Jenner, patent attorney and mechanical expert, 608 F St., Washington, D. C. Established 1883. I make a free examination and report if a patent can be had and exactly what it will cost. Send for circular.

COAL DEPARTMENT
Hookway's Storage Warehouse

W. E. HOOKWAY, Proprietor

715-733 EAST WATER STREET

D., L. & W. SCRANTON COAL

Out New Clinton Street Trestle

Phones 1114

Timken Roller Bearing Co.,
 Canton, Ohio.

SYRACUSE, N. Y. June 4, 1910

Gentlemen:

I wish to inform you my experience with your axles. I have seventy-six horses and necessary drays, vans, and coal wagons, and have one of the largest trucking and coal business in this state.

Four years ago I commenced to change axles of my wagons, taking off a set of common axles every month and putting a set of yours in their place. During this time I have never had a cone break, no trouble, no bother. Two horses now do the work of three-horse rigs, and my competitors in the coal business cannot compete, as I can draw more coal with less wear and tear and expense than they can. No one could give me a wagon and have me use it unless it was equipped with a set of your axles. They certainly cut down expense and enable one to draw big loads cheaply and quickly.

Very truly yours,



HANDY LAMP
GASOLINE
LIGHTING SYSTEM

Draws Trade to Your Shop.

Gives a 300 Candle Power Shadowless Light the instant you move the lever. Turns up or down, like gas, burns dim when not in use, or can be turned up instantly when more light is needed. It floods a 30-foot space with a brilliancy like daylight. Far cheaper than gas, kerosene or electricity, and so simple that anyone can use it. You can depend on it for years for any purpose demanding a big, strong light. Catalogue H tells why: Send for it now.



BRILLIANT GAS LAMP CO.
 DEPT. 29. 42 STATE ST. CHICAGO, ILL.

Jones Wheels
 BEST ON EARTH

KANTSAMORE

Phineas Jones & Co.
 Newark, N. J.

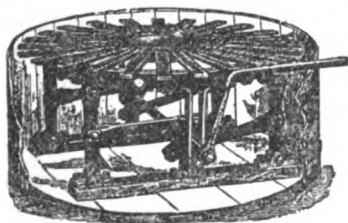

The Bokop Tire Setter and Cooler

Is the Best and Only Machine that has stood the test during the last 12 years on all classes of work, and is the Only Machine built with the Indestructible Wrought Iron Face Plate. Over 1,000 are in successful operation, repairs on which have not exceeded \$6.00 in the last 12 years. For prices, references and descriptive circulars, address **BOKOP, WEBB & PALM, Defiance, Ohio**

E. SCOTT PAYNE CO.

OF BALTIMORE CITY
CARRIAGE AND AUTOMOBILE
HARDWARE

362 and 364 North Gay Street,
 BALTIMORE, MD.

CARRIAGE SPRINGS OF EVERY STYLE AND PAT-
 TERN TO ORDER

Also Curtzin Rollers and Concealed Hinges
EXCLUSIVELY FIRST-CLASS WORK
 THE BEST THAT CAN BE MADE

SPRING PERCH CO.
 BRIDGEPORT, CONN.

Please mention "The Hub" when you write.

HOTEL CUMBERLAND

NEW YORK

Southwest Cor. Broadway at Fifty-fourth St

Near 50th St. Subway Station, 53d St. Elevated and all Surface Lines.



**Headquarters for
Carriage and
Automobile Trade**

Ideal Location, Near Theatres,
Shops and Central Park.

**NEW AND FIREPROOF
STRICTLY FIRST-CLASS**

RATES REASONABLE
All Hardwood Floors and
Oriental Rugs.

Ten Minutes Walk to
Twenty Theatres.

Transient Rates, **\$2.50** with Bath, and up.

Excellent Restaurant. Prices Moderate.

SEND FOR BOOKLET.

HARRY P. STIMSON,
Formerly with Hotel Imperial.

R. J. BINGHAM,
Formerly with Hotel Woodward.

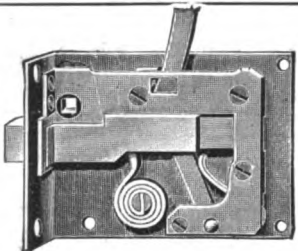

A. OCHSNER & SONS CO.
NEW HAVEN, CONN.

Auto and Carriage
Locks, Hinges, Etc.

Every Vehicle Dealer Should Read

The Hub

\$2.00 a year. Trade News Pub. Co., New York, N.Y.

ESTABLISHED 1886.

Correspondence School of Carriage and Motor Carriage Drafting

A thorough, practical tuition is given through this correspondence school. The theory and practice of construction, bookkeeping, perspective. Many men now hold good positions through taking the courses of instruction.

Principal, THOS. MATTISON,
Hillside Avenue, Bitterne Park,
Southampton, England.

Author of "The Coach Body Makers' Guide," \$3.00; a practical treatise on "The Suspension of Carriages," "Bookkeeping," and other carriage building works.

INDEX TO ADVERTISEMENTS.

| | |
|------------------------------------------------|-----------|
| American Ball Bearing Co., The | 2nd cover |
| American Roller Bearing Fifth Wheel Co. | 3 |
| Ault & Wiborg Co., The | 3 |
| Bailey & Co., Inc., S. R. | 16 |
| Bokop, Webb & Palm | 11 |
| Bennett Mfg. Co. | 20 |
| Bentel & Margedant Co., The | 6 |
| Brilliant Gas Lamp Co. | 11 |
| Cately & Ettling | 22 |
| Cincinnati and Hammond Spring Co. | 22 |
| Columbus Bolt Works | 4th cover |
| Consolidated Rubber Tire Co. | 17 |
| Cowles & Co., C. | 20 |
| Crane & MacMahon | 2nd cover |
| Devoe, F. W., & Reynolds Co., C. T. | 3rd cover |
| Eagle White Lead Co., | 6 |
| Eberly & Orris Mfg. Co. | 3rd cover |
| Eccles Co., Richard .. | 20 |
| Eureka Bending & Wheel Co. | 16 |
| Gifford & Son, John A. | 21 |
| Goodrich Co., B. F., The | 5 |
| Goshen Eyelet Co. | 14 |
| Herbrand Co., The | 22 |
| Higgin Mfg. Co. | 18 |
| Hoopes Bro. & Darlington, Inc. | 2nd cover |
| Indianapolis Dash Co. | 22 |
| Jones & Co., Phineas | 11 |
| Keystone Paint & Filler Co. | 4 |
| Keystone Forging Co. | 16 |
| Keystone Spring Works | 18 |
| Kilvington, S. W. | 16 |
| Kimble, Andrew | 4 |
| Keagy & Lear Machine Co. | 22 |
| Masury & Son, John W. | 1 |
| McKinnon Dash Co. | 4th cover |
| Mercer, Geo. J. | 20 |
| Milton Mfg. Co. | 20 |
| Moller & Schuman Co. | 2 |
| Mott Wheel Works | 3rd cover |
| Murphy Varnish Co. | 4 |
| National Aluminum & Bronze Co. | 3rd cover |
| New Wapakoneta Wheel Co., The | 4th cover |
| Ochsner & Sons Co., A. | 12 |
| Payne Co., E. Scott | 11 |
| Porter, H. K. | 20 |
| Pullman Motor Car Co. | 13 |
| Russell, Burdsall & Ward Bolt and Nut Co. | 3rd cover |
| Schubert Bros Gear Co. | 16 |
| Shortsville Wheel Co. | 18 |
| Smith & Co., Edw. | 2 |
| Spring Perch Co. | 11 |
| Standard Oil Cloth Co. | 19 |
| Standard Wheel Co. | 6 |
| Timken Roller Bearing Co. | 11 |
| Uebelmesser Co., Charles R. | 14 |
| United States Varnish Co. | 2 |
| Valentine & Company | 2 |
| West Tire Setter Co. | 16 |
| Wilcox Mfg. Co., D. | 15 |
| Willey Co., C. A. | 4 |
| Woodman, Joel H. | 14 |

Please mention "The Hub" when you write.

Pullman

AUTOMOBILES

“ASK THE NEAREST OWNER”

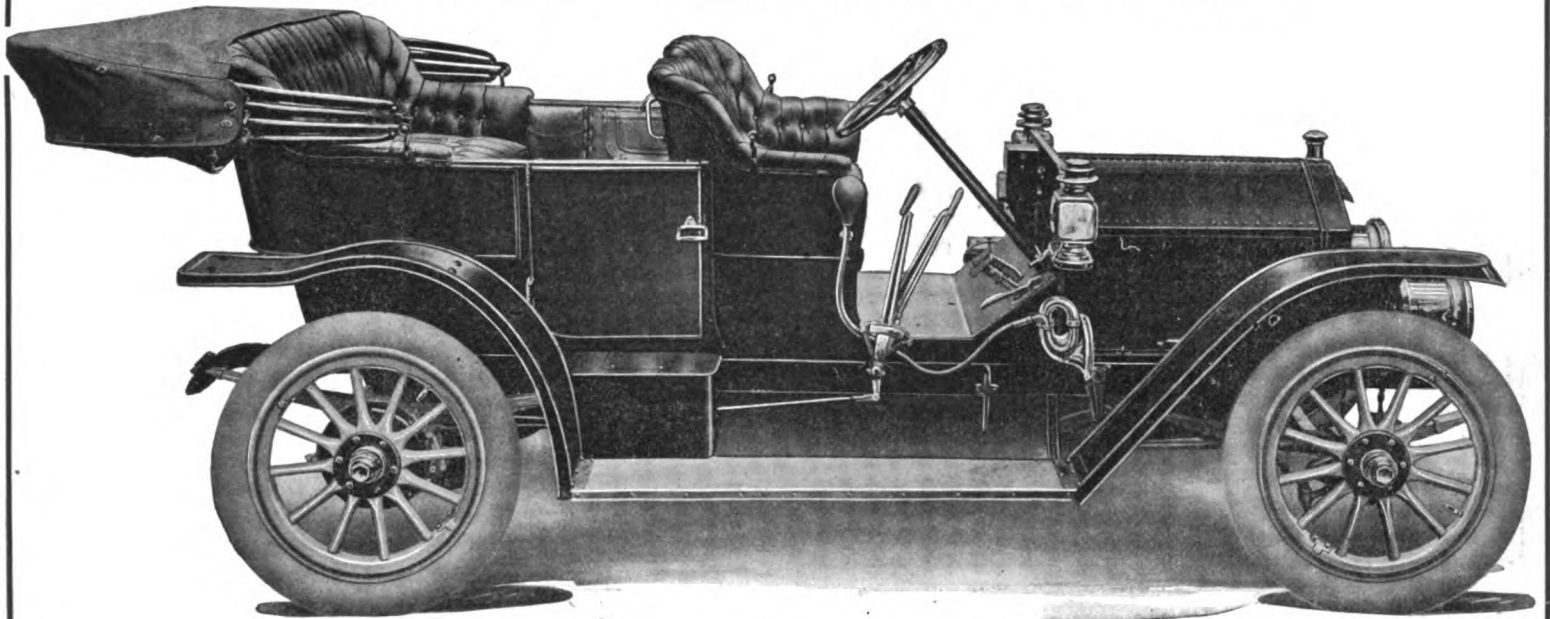

Model K-11.. 35 H. P., Price, \$2,000.00 -:- See Specifications, page 182, this issue.

The fine reputation which PULLMAN Automobiles enjoy among motorists of discrimination—those who are **experienced judges of automobile value** and do not appraise a car merely by externals—is the result of the consistent performance of the car in service. And by **service** we mean the severest usage that any motor car can be subjected to.

The PULLMAN Automobiles are recognized to be free from troubles, and every garage and repairman who knows **good mechanical design and construction** gives the PULLMAN a **good name**.

“PULLMANS ARE NOT REPAIR SHOP HABITUES”

The following letter is a sample of those which enthusiastic owners of PULLMANS are constantly writing us:

ASA B. GARDINER, Jr. Office: 524 N. Calvert St., Baltimore, Md. Residence: Cockeysville, Md.,
 PULLMAN MOTOR CAR CO., York, Pa. August 23, 1910.
 Gentlemen:—The Pullman Model O, 1911 car I took on a 1,400 mile tour through Pennsylvania and New York State with complete satisfaction, without trouble of any kind, except two punctures, and everywhere I found the car all I expected of it, and it certainly has made its reputation, for in every garage there was nothing but good words for the “Pullman.”
 Yours truly, (Signed) ASA B. GARDINER, Jr.

We are desirous of securing energetic, progressive vehicle and implement dealers to represent us in the territory still unallotted. Our agency proposition for 1911 is unusually attractive to that class of dealers who wish to represent a **Permanent** car in service and who are in business **Permanently**.

This class of dealers is strongly urged to write or wire to us immediately for territory if we have no representative in their section.

Only a limited number of PULLMAN cars will be built in 1911 season for deliveries on specified dates, and it behooves **live dealers** to get in communication with us at once, or preferably to come to our factory and see our facilities for turning out the **Permanent** PULLMAN.

WRITE FOR ADVANCE 1911 PRINTED MATTER. IMMEDIATE DELIVERIES OF 1911 CARS.

Pullman Motor Car Company, York, Pa.

Licensed under Selden Patent.



Painters and Decorators Save Time, Labor and Money, using the

Uebelmesser Striping and Stencil Wheel

With this simple, clean and rapid-action tool the most ordinary decorator can do the finest striping and stencil work and produce a bigger day's work with less labor than by the old-fashioned method. Complete directions are furnished with each tool. They are as simple as the tool itself.

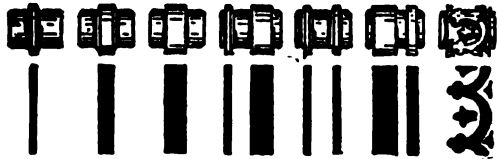

Just a few of the many designs that can be produced with the Uebelmesser Painters' and Decorators' Tool. (The designs shown above are reduced in size)

Complete Outfit consisting of Machine, 10 Plain and 10 Ornamental Wheels, only... **\$5.50**

LIBERAL DISCOUNT TO THE TRADE

Manufactured by

Charles R. Uebelmesser Company
Bayside, New York, N. Y.

Advertisements Classified

The following list includes advertisers in THE HUB. Each advertiser is entitled to name under one heading only. An extra charge for name under more than one heading.

Automobiles

Auto-Bug Co., The, Norwalk, O.
Pullman Motor Car Co., York, Pa.

Axles, Etc.

American Ball Bearing Co., Cleveland, Ohio.
Keagy & Lear Machine Co., Coshocton, Ohio.
Timken Roller Bearing Co., Canton, Ohio.

Bodies, Seats, Etc.

Kilvington, S. W. Wilmington, Del.
Woodman, Joel H., Hoboken, New Jersey.

Bolts and Nuts.

Columbus Bolt Works, Columbus, Ohio.
Milton Mfg. Co., Milton, Pa.
Russell, Burdall & Ward Bolt and Nut Co., Port Chester, N. Y.

Carriage Forgings.

Columbus Bolt Works, Columbus, Ohio.
Eccles Co., Richard, Auburn, N. Y.
Keystone Forging Co., Northumberland, Pa.

Carriage Hardware.

Cately & Ettlmg, Cortland, NY
Crandall, Stone & Co., Binghanton, N. Y.
Cleveland Hardware Co., The, Cleveland, Ohio.
Eberhard Mfg. Co., The, Cleveland, Ohio.
Gifford & Son, John A., New York.
Herbrand Co., The, Fremont, O.
Ochsner & Sons Co., A., New Haven, Conn.
Frost Co., E. Scott, Baltimore, Md.

Carriage Goods.

Cowles & Co., C., New Haven, Conn.
Gifford & Son, John A., New York.
Higgin Mfg. Co., Newport, Ky.

Dashes, Fenders, Rails, Etc.

Fennett Mfg. Co., Alden, N.Y.
Indianapolis Dash Co., Indianapolis, Ind.
McKinnon Dash Co., Buffalo, N. Y.

Fifth Wheels.

American Roller Bearing Fifth Wheel Co., Brooklyn, N. Y.
Wilcox Mfg. Co., D., Mechanicsburg, Pa.

Finished Vehicles.

Bailey & Co., Inc., S. R. Amesbury, Mass.
Staver Carriage Co., Chicago, Ill.

Gear Irons

Wilcox Mfg. Co., D., Mechanicsburg, Pa.

Gear Woods.

Andrew Kimble, Zanesville, O.

Lamps.

Brilliant Gas Lamp Co., Chicago, Ill.
Gifford & Son, John A., New York.

Machinery and Tools.

Margedant Co., The, Hamilton, Ohio.
Eokop, Webb & Palm, Defiance, Ohio.
Porter, H. K., Everett, Mass.
West Tire Setter Co., Rochester, N. Y.

Miscellaneous.

Goshen Eyelet Co., Goshen, Ind.
National Aluminum & Bronze Co., Indianapolis, Ind.
Standard Oil Cloth Co., New York.
Uebelmesser Co., Charles R. Bayside, New York, N. Y.

Rubber Tires.

Consolidated Rubber Tire Co., New York City.
Goodrich Co., B. F., Akron, O.

Shaft Couplings and Anti-Rattlers.

Eccles Co., Richard, Auburn, N. Y.
Metal Stamping Co., New York City.

Springs and Gears.

Cincinnati & Hammond Spring Co., Cincinnati, Ohio.
Keystone Spring Works, Inc., Philadelphia, Pa.
Mulholland Co., Dunkirk, N. Y.
Spring Perch Co., Bridgeport, Conn.

Varnishes, Paints and Japans.

The Ault & Wiborg Co., Cincinnati, Ohio.
Devoe, F. W., and C. T. Reynolds Co., New York City.
Masury & Son, John W., New York and Chicago.
Moller & Schumann, Brooklyn, N. Y.
Murphy Varnish Co., Newark, N. J.
Smith & Co., Edw., New York.
United States Varnish Co., Cincinnati, Ohio.
Valentine & Co., New York, Chicago, Boston, Paris.
Wiley Co., C. A., Hunter's Point, New York City.

Wheels.

Crane & MacMahon, New York.
Eureka Bending & Wheel Co., The, York, Pa.
Gifford & Son, John A., New York.
Hoopes Bro. & Darlington, West Chester, Pa.
Jones & Co., Phineas, Newark, N. J.
Keoketa Wheel Co., Ohio.
Shortsville Wheel Co., Shortsville, N. Y.
Standard Wheel Co., Terre Haute, Ind.
Wheel Stock, Bent Wood, Etc.
Crane & MacMahon, New York.
White Lead.
Eagle White Lead Co., Cincinnati, Ohio.

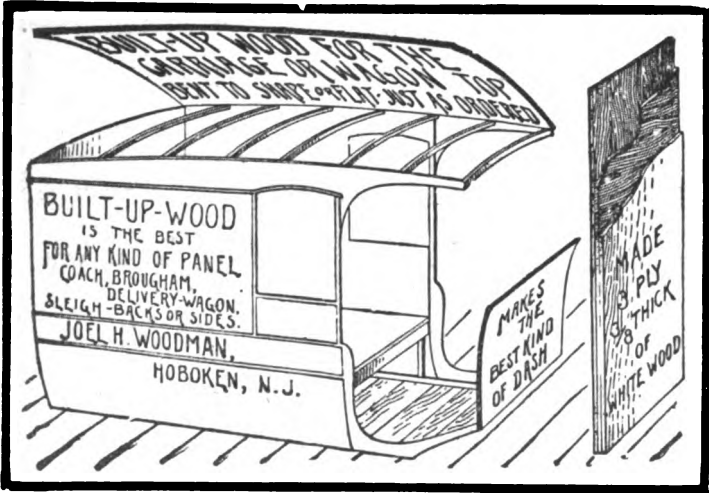

Goshen Eyelet Co.

Manufacturers of

Carriage Top Trimmings

GOSHEN, INDIANA

HEADQUARTERS FOR SPECIAL

FINE GEAR IRONS [Drop Forged] CARRIAGE HARDWARE

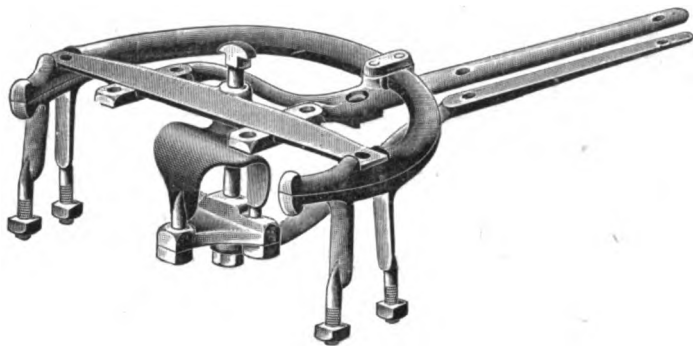

No. 1908—Gear Iron

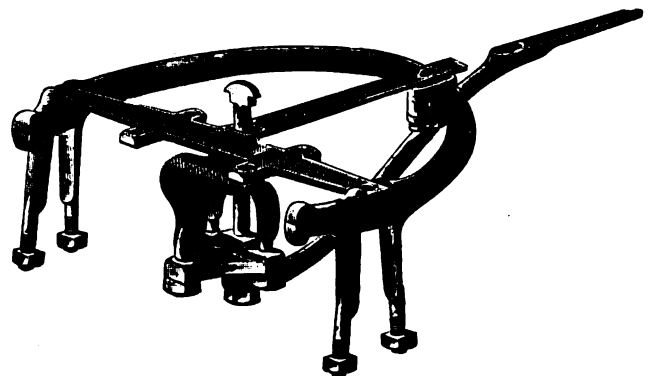

No. 2000—Gear Iron

WILCOX'S Mechanical 3 Prong King Bolt

Double Locked in Head Block
Plate and King Bolt Yoke. No
Strain on Bolt. No Turn on
Nut. Guaranteed.

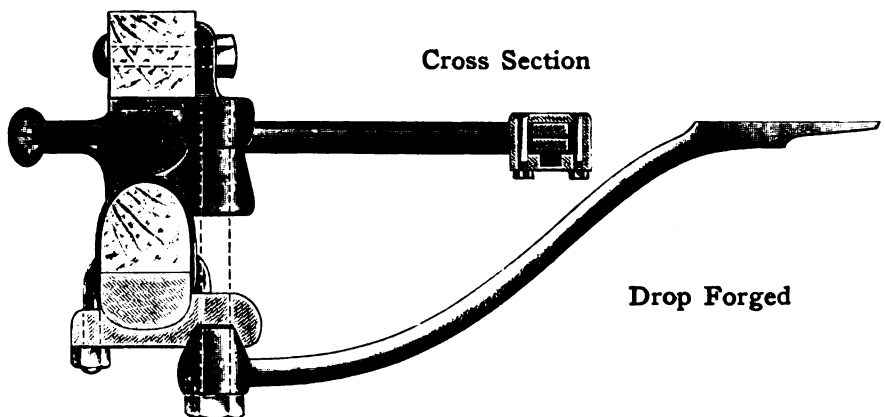

Cross Section

Drop Forged

Patented

SURE
SAFE

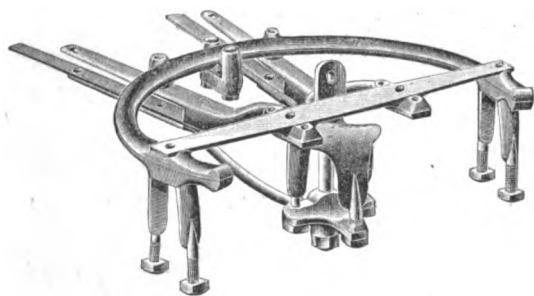

No. 1905—Gear Iron

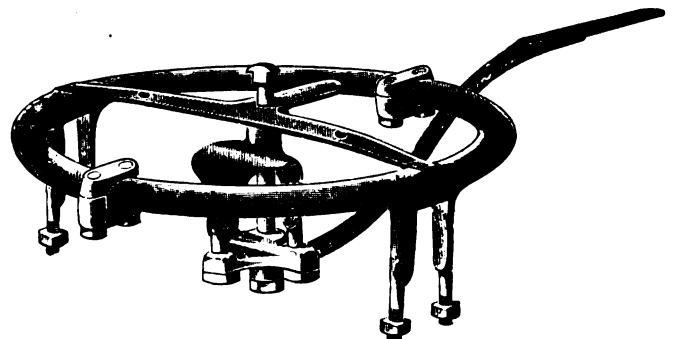

No. 1909—Concord

Forget your trouble and decide at once to use WILCOX DROP
FORGED IRONS. Write us for pleasure

The D. Wilcox Mfg. Co. Mechanicsburg Pa.

Please mention "The Hub" when you write.

CARRIAGE FORGINGS



PATENTED DEC. 3, 1901

**The Standard Body Loop
None Like it. None Equal to it.**

A popular loop which is unequaled by any on the market.

We also make a full line of
CARRIAGE FORGINGS

THE KEYSTONE FORGING COMPANY
Northumberland, Penna.

FIFTH WHEELS

**The Well Known
SUPERIOR BRAND
OF
FIFTH WHEELS**

**Manufactured By Us Has No
Equal On The Market.**

Write us for Particulars and Prices.

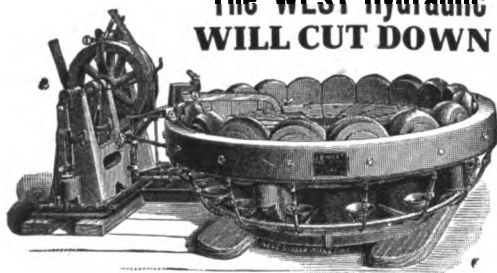

The WEST Hydraulic Tire Setter WILL CUT DOWN EXPENSE

Tires set cold in one minute. This machine saves time — does the work better and quicker, does away with burned streaks. Only necessary to measure one wheel in a lot. Does not char the rim and

thus make the tire loosen prematurely. Saves re-sandpapering of wheels.

This machine is now increasing the profits of many manufacturers. Send for catalog and read about it.

WEST TIRE SETTER CO., ROCHESTER, NEW YORK

SAMUEL W. KILVINGTON

HAND-MADE

Automobile Bodies

LIMOUSINES, TOURING CARS AND RUNABOUTS DESIGNED TO FIT ANY CHASSIS. HIGH GRADE WORK.

Estimates on Any Style Cheerfully Given.

THIRD AND WALNUT STREETS.

WILMINGTON, DEL.

Philadelphia Office: AUTO TOP AND BODY CO., 257-259 N. Broad St.

S. R. BAILEY & COMPANY, Inc.

Makers of the Celebrated.

WHALEBONE ROAD WAGON

AMESBURY, MASS.

VEHICLES AND GEARS IN THE WHITE

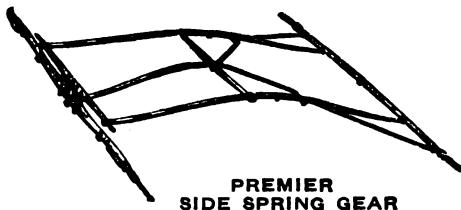

PREMIER
SIDE SPRING GEAR

We manufacture a full line of Carriage and Wagon bodies in the white; also Limousine, Taxicab, Touring Car and Roadster Bodies for automobiles in metal. Fifty styles of gears for Carriages and Wagons; also seats, trimmings and tops of all kinds.

Write to us for particulars.

Schubert Bros. Gear Company

ONEIDA, NEW YORK.

W. G. LEAS, Pres. and Treas. J. L. BOWER Sec'y and Mgr.

Eureka Bending & Wheel Works

YORK, PA,

MANUFACTURERS OF

Second-Growth Hickory and Oak Bent Rims,

Gear Wood, Buggy Bows, Bob Runners and Bent Stock.



Manufacturers and Dealers
in all kinds of

LUMBER

THE Cleveland Hardware Co.

PRODUCERS OF

DROP FORGINGS

FOR

Carriages, Wagons, Automobiles

A COMPLETE LINE OFFERED OF

Carriage

BODY HANGERS
 SPRING BARS
 ROLLER CHAFE IRONS
 STEPS
 BOW SOCKETS
 SHIFTING RAILS
 TOP JOINTS
 REACH PLATES
 STAY BRACES
 CLIPS
 COUPLINGS
 POLE IRONS
 SHAFT IRONS
 GEAR SETS

Wagon

BRAKES
 BOX RODS
 BOX STRAP BOLTS
 TOP BOX FASTENERS
 SIDE BRACES
 BOLSTER IRONS
 WRENCHES
 POLE IRONS
 CLEVISES
 SINGLETREE IRONS
 DOUBLETREE IRONS
 AXLE CLIPS
 WELDED RINGS
 PLOW CLAMPS

Automobile

STEP HANGERS
 BOW SOCKETS
 BODY TOP IRONS
 SPRING CLIPS
 LAMP BRACKETS
 YOKE ENDS
 ROD ENDS
 LEVERS
 GEAR BLANKS
 STARTING CRANKS
 FENDER IRONS
 PEDAL STEPS
 STEERING BALL ARMS
 CRANK SHAFTS

Catalogue No. 12 for descriptions and sizes.

THE CLEVELAND HARDWARE COMPANY

Manufacturers.

E. 45th and Lakeside Ave.,

CLEVELAND, OHIO

JOHN W. MASURY & SON

Originators of

Superfine Coach and Automobile Colors

Acknowledged the Standard for Fifty Years

AND MANUFACTURERS OF

Fine Carriage and Automobile Varnishes

New York, Chicago, Minneapolis, Kansas City

Increase Your Sales ?



By having your Buggies equipped with **CATELY'S BUGGY TOP SPRINGS AND LEVERS.**

Pull on the inside levers and the top is lowered with ease. A gentle start and the top is up. Prevent broken bows and rattling joints. Best of talking points to interest trade and help sell your buggies. Manufacturers will put the springs and levers on your buggies when you so specify. Some manufacturers put springs and levers as part of regular equipment.

SELF ACTING SPRING on some styles of their buggies as part of regular equipment. Yours for the asking. We also have trade winners in standard Third Seats, Camp Stools and Auto Chairs. The prices are low so write for catalog.

CATELY & ETTLING, Cortland, N. Y.
Members Carriage Builders' National Association.

The WEST Hydraulic Tire Setter WILL CUT DOWN EXPENSE



Tires set cold in one minute. This machine saves time — does the work better and quicker, does away with burned streaks. Only necessary to measure one wheel in a lot. Does not char the rim and

thus make the tire loosen prematurely. Saves re-sandpapering of wheels.

This machine is now increasing the profits of many manufacturers. Send for catalog and read about it.

WEST TIRE SETTER CO., ROCHESTER, NEW YORK



THE INDIANAPOLIS DASH COMPANY

Manufacturers of High-Grade

DASHES AND FENDERS

ALSO ROLL-UP-STRAPS

AND PROPS BLOCK WASHERS

INDIANAPOLIS,

INDIANA.

Please mention "The Hub" when you write.

The A. & W. Co.

Auto, Carriage and Wagon Varnishes



The Quickest Thing in Quick
Rubbing Varnish
Use it and Save Time and Trouble

THE AULT & WIBORG CO. VARNISH WORKS
Cincinnati, Ohio.

If you have
Varnish Troubles
consult us. We
probably have
the remedy.

CUT THIS OUT AND MAIL.

Ault & Wiborg Co. Varnishes Works
CINCINNATI, OHIO

Please send free of charge and prepaid, a Working Sample of
"RUBFAST"

Name _____

Address _____

We will sell 100 of these
solid bent seats at cost.



No. 68.

A few other styles
for prompt delivery.

THE FRANTZ BODY MFG. CO.
AKRON, OHIO.

METAL DASHES

For Horse Drawn Vehicles.
Use Them on Your Output of Spring
Wagons Next Season.

They Are Cheaper and More
Durable Than Leather.

WRITE FOR CATALOG.

BENNETT MFG. CO. ALDEN, N. Y.

'GRAMM'
The World's Best
Why Should You
Buy a
"GRAMM?"

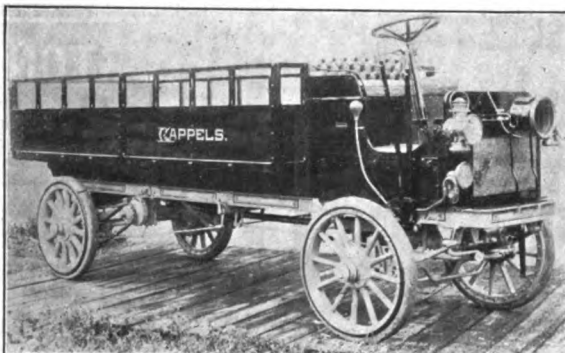

A Two-Ton Furniture Type Truck

Because—
IT'S THE "BEST"
Three-Point Motor Suspension
Clutch That's
Indestructible
Built Exclusively
in Our Own Plant

Factories—Lima, Ohio
Bowling Green, Ohio

THE GRAMM MOTOR CAR CO. Bowling Green, Ohio

Please mention "The Hub" when you write.

Good Salesmen

Good Economists

Good Advertisements

MURPHY PALEST MOTOR CAR BODY AND MURPHY PALEST DURABLE BODY

These great Finishing Varnishes sell Cars and Carriages; Reduce the cost of up-keep; Get new Customers.

Enough for a Car or a Carriage costs \$5⁰⁰—possibly \$6⁰⁰. The other materials and the labor bring the cost of a Finish up to \$40⁰⁰ or \$60⁰⁰ or \$100⁰⁰ or more.

It is the Finishing Varnish that gets the wear: that prolongs or shortens the life of the Finish.

The Manufacturer can save a dollar or two on the Finishing Varnish; and oblige the Customer to revarnish twice as often—but that is bad advertising.

Murphy Varnish Company

FRANKLIN MURPHY
President

NEWARK

BOSTON

CLEVELAND

ST. LOUIS

CHICAGO

Associated with Dougall Varnish Company, Limited, Montreal, Canada

The Varnish That Lasts Longest

WILLEY'S COLORS

The RECOGNIZED STANDARD



C. A. WILLEY CO.

COLORS GRINDERS

and Manufacturers of Specialties in

CARRIAGE, AUTOMOBILE AND CAR

PAINTS

COLORS, VARNISHES, ETC.

HUNTER'S POINT, NEW YORK CITY

KIMBLE'S FAMOUS GEAR WOODS

still represent the highest standard of excellence and quality. True to our motto our line wins the approval of all vehicle builders.

WHAT CAN WE DO FOR YOU?

ANDREW KIMBLE

ZANESVILLE, O.

KEYSTONE BLACK FILLER

MAKES A PERFECT

ROUGHSTUFF

For Automobile Bodies and Parts

It fills the pores of Metal and Wood perfectly. Sandpapers easily and produces a fine, smooth surface that DOES NOT CRACK, SCALE NOR PEEL.

POMEROY & FISCHER, New York
Selling Agents to Vehicle Trade

KEYSTONE PAINT AND FILLER CO., Muncy, Pa.

For You The Carriage Dealer

The article that follows is taken from the July number of "Judicious Advertising." It describes very appreciatively what the B. F. Goodrich Company is doing for the Carriage Dealer. If this sort of original and direct advertising appeals to you, the B. F. Goodrich Company welcomes an opportunity to help you present the decided merits of Goodrich Solid Rubber Carriage Tires to the Carriage Owners of your community.

Framing the Dealers' Campaign

"THE business of getting close to the dealer, one phase of which was exploited in the June number of 'Judicious Advertising,' is shown in this campaign in concrete form. The campaign was first worked out with the firm of Harrah & Stewart Company, Des Moines, Iowa, one of the large number of Goodrich dealers. It consisted merely of follow-up matter to the carriage owners of Des Moines, the idea be-



"In Des Moines Prosperity is a Habit."
—Wealth

ing to hammer home the thoughts in the dealers' advertising locally. The work of the Goodrich Company for its dealers exemplifies a basic business principle that is of tremendous importance to manufacturers all over the country.

"For the Des Moines dealers, the advertising department undertook the planning of an advertising campaign which would present the advantages of their service and of the Goodrich product. To the carriage owners of Des Moines one of these leaflets will be sent out each month.

"It was sought to make the advertising very local—something that would appeal to every loyal citizen in Des Moines. Therefore, 'The Des Moines Idea'—that is to say the keen public spirit of Des Moines people—suggested itself as a motive.

"A great deal of care was taken with the drawing on the leaflet, to reproduce those scenes which would interest the citizen and which would

beget attention. The phrases from 'Wealth,' the publication issued by the Greater Des Moines Committee, and featured in its national advertising campaign, were the cue for the talk which followed on the inside of the leaflet. No suggestion was given in the outside as to what was contained within, yet care was taken to make the connection between the two logical and clear. In other words, this experiment was undertaken with the idea of putting the advertising matter of one firm in the community on a higher plane than is customary—that is, to attach it to the broader interests, to the interests of the community as a whole, and thus to make it social, and give it, so to speak, an ethical quality.

"It identifies the interest of the individual buyer looking out for himself, with the broader interest of the whole body of buyers—that is, with the City of Des Moines.

"The feat of taking advantage of the national advertising of the city of Des Moines, naturally,



"Life is Worth Living in Des Moines"
—Wealth

Wingman Boulevard.

was bound to attract tremendous interest in the leaflet to the Des Moines carriage owners, into whose hands the matter went.

"Such ideas promulgated for the benefit of the dealer are bound to cement the manufacturer's relation with him, and after all, that is the process which sells most goods. Such exhibition of good feeling for the dealer accomplishes results along lines of easiest resistance."

Tell Us What We Can Do For You. Address

THE B. F. GOODRICH COMPANY
AKRON, OHIO

TRADE **VALENTINES** MARK

Valentine's Vanadium

and

Vanadium-Color Varnishes

TRADE **VALENTINES** MARK

JUST THE VARNISH FACTS

"Nothin' nowhere" gets the hard knocks that come to varnish that covers a motor car.

VANADIUM

VARNISH meets this trouble. That is one of the reasons—only one—why it shines as a Conspicuous Achievement in Varnish making. A new means of meeting a new trouble.

Now, combine such a varnish with a dependable Valentine Color, and you get the next step,

VANADIUM

COLOR-VARNISH. The combination of TWO good articles is—well, what would be the combination of two good things? Super-goodness would do, but we just say VANADIUM COLOR-VARNISH.

There is no need to palter with words

VANADIUM VANADIUM

VARNISH and COLOR-VARNISH are distinctly new and remarkable in the trade. The color-card is now ready for you. It embraces thirteen of the standard shades, but we grind "specials," if wanted.

But the main thing is—test the good articles placed in your hands, Mr. Painter

VALENTINE & COMPANY

New York

Chicago

Boston

Toronto

Paris

Amsterdam

83 Years' Experience in Every Can

Edward Smith & Co.

CARRIAGE VARNISHES

Everything from the
Bare Wood to the Finishing Coat.

CHICAGO

NEW YORK

TO WHOM IT MAY CONCERN

It has come to our knowledge that some of the wheel makers, and dealers in wheels, have said to the trade that we are so busy on automobile wheels, that we do not care to receive orders for horse vehicle wheels. We wish to say that this is not true. We want all the orders that we can get for regular wheels, and would say we give more money value than any—we grade high. We finish our work well and our deliveries are more prompt. To our old customers—we ask your orders; and to those who have not used our wheels, a trial order.

We guarantee satisfaction, and if our wheels do not please you when you get them, you can ship them back at our expense. We recently received a letter saying: "Make these wheels 'B' grade, as I think them equal to most any other makes that are marked 'A' grade."

The next order for wheels you give out, please send to us—whether one set or more. Please let us hear from you.

Your very truly,
Newark, N. J., Oct. 5, '10. PHINEAS JONES & CO.

RUB ————— RUB ————— RUB

THAT'S THE EXPERIENCE SOME PAINTERS HAVE WITH A POOR RUBBING VARNISH. THEY RUB TILL THEIR HEART ACHES ONLY TO HAVE THE VARNISH SWEAT, OR ROLL UP UNDER THE PAD

XX Diamond Rubbing and Hard and Quick Drying Rubbing "A"

DRY HARD TO RUB IN TWO DAYS, WITHOUT SWEATING, ARE TOUGH AND THE BEST FOUNDATION FOR FINISHING COATS.

MADE BY **MOLLER & SCHUMANN CO.**

MARCY AND FLUSHING AVES.,

BROOKLYN, N. Y.

The Hub

Copyright, 1910, by the Trade News Publishing Co. of New York.

Entered in the New York Post Office as Second-class Matter.

Vol. LII.

NOVEMBER, 1910.

No. 8.

THE TRADE NEWS PUBLISHING CO. OF N. Y. Publishers of THE HUB

J. H. WRIGHT, *President.* G. A. TANNER, *Secretary and Treasurer.*
24-26 MURRAY STREET, NEW YORK.

Other Publications of Trade News Publishing Co.:
HARNESS (monthly)per year, \$1.00
AMERICAN HARNESS AND SADDLERY
DIRECTORY (annual)per copy, \$4.00

THE HUB is published monthly in the interest of employers and workmen connected with the manufacture of Carriages, Wagons, Sleighs, Automobiles and the Accessory trades, and also in the interest of Dealers.

Subscription price for the United States, Mexico, Cuba, Porto Rico, Guam the Philippines, and the Hawaiian Islands, \$2.00, Canada, \$2.50, payable strictly in advance. Single copies, 25 cents. Remittances at risk of subscriber, unless by registered letter, or by draft, check, express or post-office order, payable to the order of TRADE NEWS PUBLISHING CO.

For advertising rates, apply to the Publishers. Advertisements must be acceptable in every respect. Copy for new advertisements must be received by the 25th of the preceding month, and requests to alter or discontinue advertisements must be received before the 15th day of the preceding month to insure attention in the following number. All communications must be accompanied by the full name and address of writer.

FOREIGN REPRESENTATIVES:

FRANCE.—L. Dupont, publisher of *Le Guide des Carrossiers*, 78 Rue Bolassiere, Paris. Subscription price, 15 francs, postpaid.

GERMANY.—Gustave Miesen, Bohn's Rh. Subscription price, 12 marks, postpaid.

ENGLAND.—Thomas Mattison, "Floriana," Hillside Avenue, Bitterne Park, Southampton. Subscription price, 12 shillings, postpaid.

Pulling Together.

The general vehicle interests will be pleased to notice in the important announcement of the freight agreement to Texas points, which was reached by a conference with the executive officers of the Southwestern roads, that the vehicle interests were united in this agreement, from the fact that they were represented by Mr. Theodore Luth, chairman of the Freight and Classification Committee of the Carriage Builders' National Association, and Mr. W. J. Evans, secretary of the National Association of Agricultural Implement and Vehicle Manufacturers. The other vehicle representatives who were present, Mr. C. A. Barnard, Cincinnati; Mr. W. N. Agnew, Flint, Mich.; Mr. E. C. Meyer, St. Louis, and Mr. C. T. Platte, Indianapolis, are members of the Advisory Committee on Freight and Classification of the Carriage Builders' National Association, and deserve great credit for keeping the general committee posted regarding all proposed changes in the matter pertaining to freight and classification, and as they are all located in different sections of the country, it is easy to understand how they can arrive at a just and proper basis governing these matters when they get their heads together.

It would be to the interest of the entire vehicle trade if

all manufacturers and jobbers of vehicles would support the good work that these gentlemen are accomplishing.

We are informed that they are now actively engaged in an endeavor to secure a proper adjustment of the unjust and arbitrary advance in minimums and rates which were instituted in the official classification territory in July. May their efforts prove successful.

Closing the Exhibit Hall.

Every year at meetings of the Carriage Builders' Association there is experienced the utmost difficulty to get even a corporal's guard to attend the association's deliberations.

Many plans have been suggested to correct this fault, some have been tried, not one has hit the mark.

The best suggestion we have so far heard is that put forth by W. P. Champney, which is that the exhibit hall should be tight shut during the time of the first session (first day of the meeting, which is always Tuesday), and to add to the drawing power of the meeting that some member of the associate trade be impressed to write a paper or speak.

The drawing power of the exhibits is the strength of self-interest, but after all, if the carriage builder is not in evidence, there is not going to be much of an inducement to stand by the exhibit. The carriage builder ought, and probably does take an active interest in the proceedings. It would be superfluous to explain why.

We suppose that the greatest deterrent to a full attendance at these meetings is the thought that, after all, it will all be printed and can be read at leisure in the "daily" or dailies of the next morning, so nothing is lost by non-attendance.

We have heard no one suggest that the proceedings should not appear in printed form until after the adjournment of the convention, but we would not be at all surprised to find that such a step would aid much in augmenting the attendance at the meetings.

Development of Design.

The motor engineer is getting historical and reminiscent these days. In England the president of the Institute of Mechanical Engineers says that the growth of the automobile movement dates from the historic trip made by Stephenson's Rocket in 1829. This is going some, but it seems to be on the reverse gear. He says that the horse-drawn carriage was nearly as great a novelty in England about the year A. D. 1600 as the motor-car in 1900, and, during the three centuries that have in-

tervened, its development and improvement have been continuous. The art of coach-building made steady and uninterrupted advance; wheel building, springs, axles and bodywork, all shared in taxing the skill of the craftsmen employed; and all bear eloquent witness to the progress made.

If the motor car has three centuries of development before it to reach the evolution attained by the horse-drawn vehicle, it will have acquired quite some experience.

The gentleman is sailing by a correct chart when he says the future of the commercial vehicle depends upon the saving of money and on nothing else—economy of first cost and economy of operation and upkeep. After everything has been done that the designer and constructor can accomplish, the rest will depend upon the road on which the machine has to operate. It is no exaggeration to say that the best motor ever built could be made a losing proposition by being used over some roads, and that many a machine that has been deemed a complete failure could have given a good account of itself if scientifically-made roads had been available.

Among other things, the shortcomings of the sliding type of change-speed gearbox was mentioned, but the president was prepared to tolerate it as being "not such an abomination as would be thought by the uninitiated."

New Way to Dry Timber.

We read of a new French idea applied to the seasoning of timber in which electricity is the agent used. It is known as the Nodon-Brottonneau method. As explained the timber is nearly immersed in a tank of water containing 10 per cent of borax, 5 per cent of resin, and a little carbonate of soda, and rests on a lead plate connected with the positive pole of a dynamo. Another similar plate lying on the exposed surface of the timber is connected with the negative pole. Thus a current of electricity can be played around the wood, from which it is said all the sap appears to be removed, while the borax and resin take its place in the pores. In a few hours the timber is taken out and dried.

Truth About Automobile Industry.

Under the above head American Industries has gathered opinions from motor car makers into a symposium which is published in its October issue.

The opinions are written by the heads or vice-heads of conspicuous concerns, and they all glisten with the rays shed by the star of hope. To read these statements not a soul could have the sensations of the little boy who whistled as he went through the graveyard in the dark of the moon.

Flat Wheels.

It appears odd that solid rubber tired wheels should "fat," but it is reported to be the fact. It is especially noted on the front wheels of the chassis. No theory is advanced, that we have seen, why this action is a result of a use of the wheels in normal work.

Freight Classification.

We have received an important announcement with reference to Texas rates and minimums, from Mr. Theo. Luth, chairman of the Freight and Classification Committee of the Carriage Builders' National Association, which will be found elsewhere in this issue.

We urge all of our readers to give this information careful attention so that each will understand exactly how this change effects their own business.

The C. B. N. A. members who attended the last annual meeting which just closed in Cincinnati, fully appreciate the efforts being put forth by the freight and classification committee in their behalf, but possibly those who are not members of the C. B. N. A., and who have not followed up the reports of this committee, may not appreciate the importance of the work being done for them, and such an announcement of their work as appears in this issue should induce all those who are not members of the C. B. N. A. to send in their application for membership and help along the good cause.

Vehicle Business Abroad.

An English contemporary says the vehicle business is so good that there is a dearth of workmen to meet requirements; that in the case of the body building part of the industry cabinet makers have been impressed into the service. This state of affairs is attributed to the motor vehicle and its demand on the draftsmen for new designs away from the hard and fast fashions that had become conventional and without variety.

"OUR POLICY."

The new ownership and management of the Implement Age outlines a policy of "good-will, kindness, helpfulness, encouragement and optimism." The editor continues:

"We believe that business has become so complex, civilization so diversified and life so strenuous, that every implement dealer, every jobber and manufacturer can find full scope for the exercise of all his faculties in successfully playing the grand game of business, and the grander game of life, and that he has no time, little interest and less concern in listening to the anvil chorus, in this or any other paper, no matter what the cause that inspires the dismal tune."

We accord the new management our sympathy, and extend to it the expression of our wish for its success. Its platform reads something like the Sermon on the Mount, and that is a most exalted model that should be beacon enough for a trade journal editor, even if at times the beacon light may become extinguished, and bearings difficult to discern.

FORD IN NEW YORK.

Henry Ford is to invade New York with an automobile factory, which will be completed by the middle of next March, the company having purchased a plot of ground on Jackson avenue at the corner of Honeywell street, in Long Island City, within a stone's throw of the Queensboro Bridge. Ground has already been broken for the first of the buildings, a concrete structure 75x265 feet. This building is being built primarily as a distributing and service plant.

The latest move on the part of the company represents an investment of over a quarter of a million dollars. A stock of parts covering every make of Ford machine since the early days will be carried, thus guaranteeing to every owner the full use and enjoyment of his car.

Vehicle Fashions for November 1910

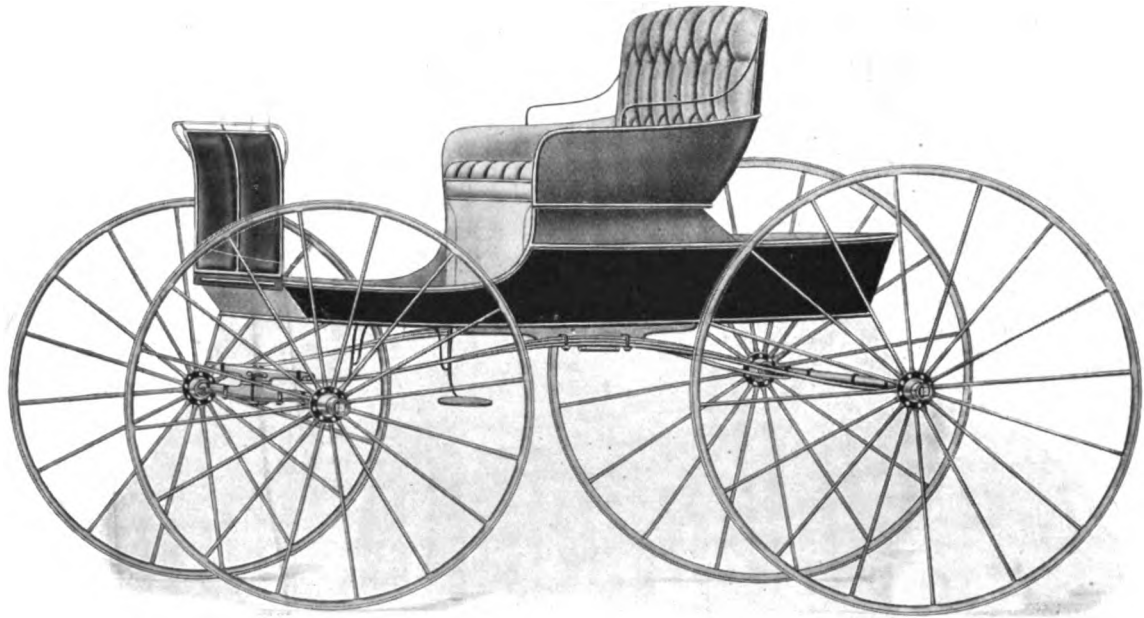

SIDE SPRING CORNING BUGGY.
Made by George White Buggy Co., Rock Island, Ill.
(Described on Page 243.)



PIANO BOX TOP BUGGY WITH AUTOMOBILE SEAT
Made by George White Buggy Co., Rock Island, Ill.
(Described on Page 243.)

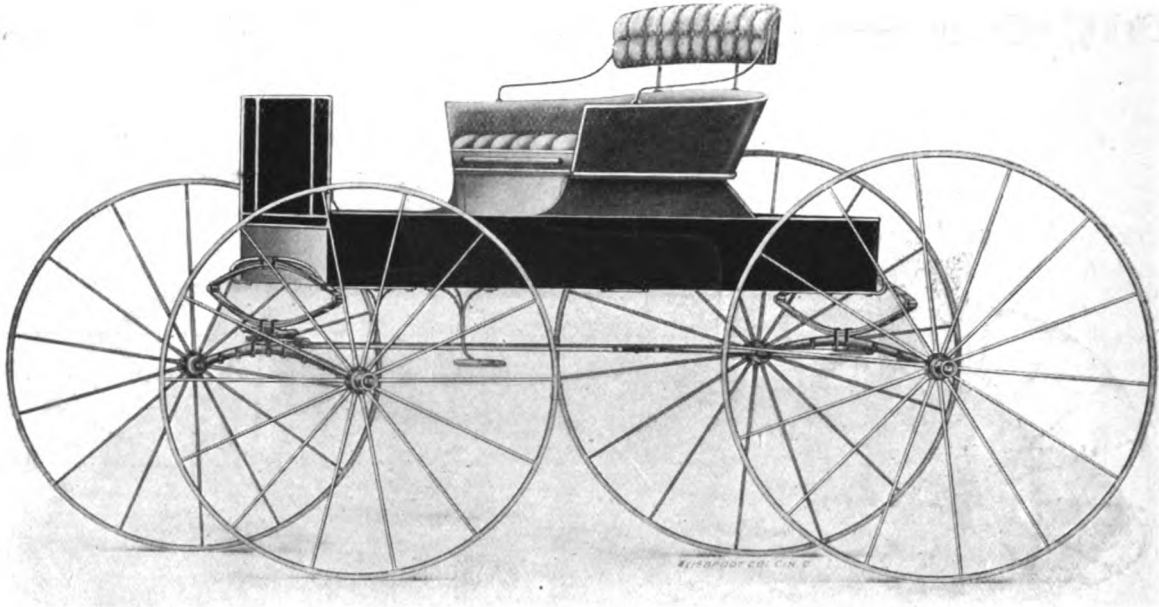

END SPRING PIANO BOX BUGGY.
 Made by George White Buggy Co., Rock Island, Ill.
 (Described on Page 243.)



DELIVERY WAGON.
 Made by Studebaker Bros.' Mfg. Co., South Bend, Ind.
 (Described on Page 243.)

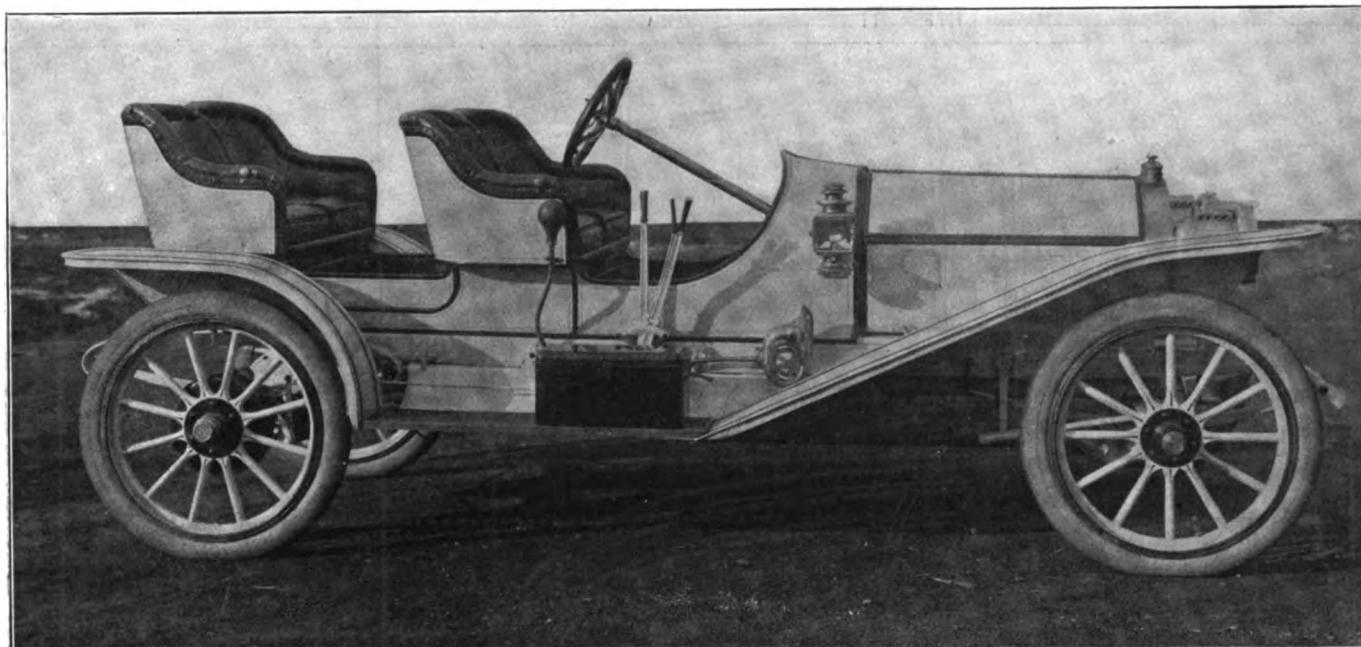

THE PARRY ROADSTER.
Made by The Parry Co., Indianapolis, Ind.
(Described on Page 243.)

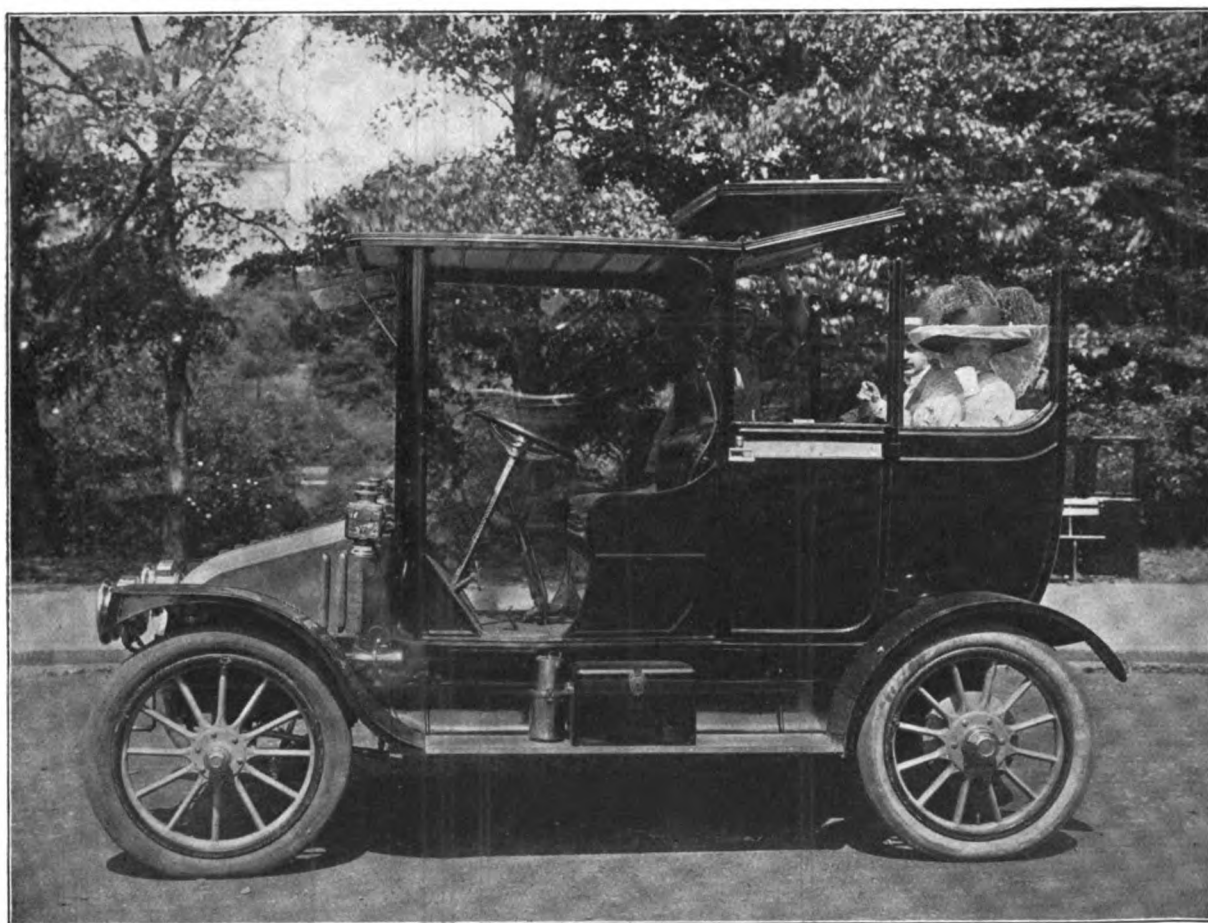

TWOMBLY CAR WITH QUICK REMOVABLE POWER PLANT.
Made by Twombly Power Co., New York City.
(Described on Page 243.)

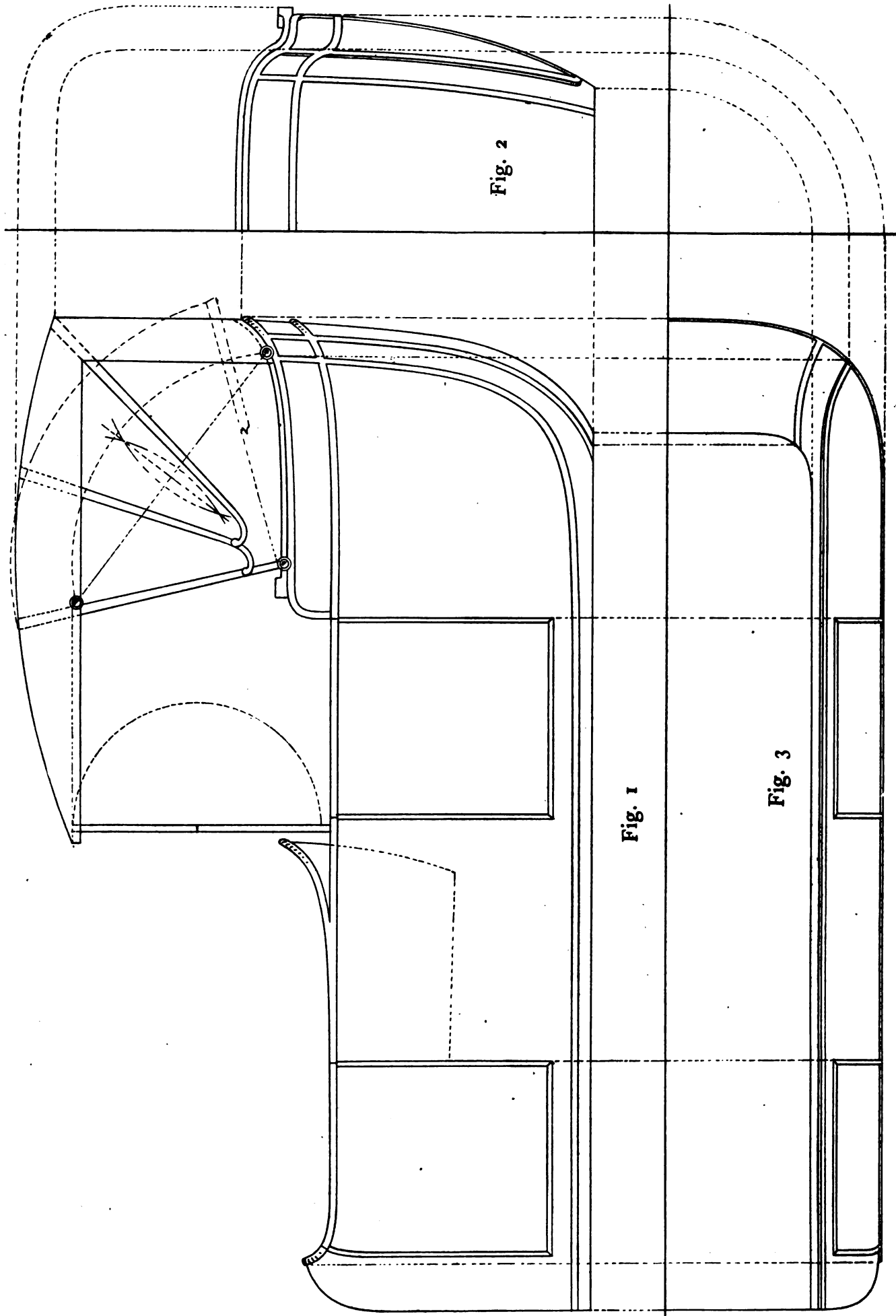

Fig. 2

Fig. 1

Fig. 3

WORKING DRAWING OF A PLAIN, HALF-HEADED, FLUSH-SIDED MOTOR BODY.
(Described on Opposite Page.)

Wood-working and Smithing

WORKING DRAWING OF A PLAIN, HALF-HEADED, FLUSH-SIDED MOTOR BODY.

Drawing on Opposite Page.

The so-called torpedo motor body, with all its hideousness, is fast dying the death of the freak. But still its style forecasted the need of a body of more uniform outline than the diversified designs currently obtaining. The torpedo body was a thought to suspend a boiler on wheels, because it has no relative connection with coach making in the matter of design, though it has served a useful purpose in starting a new line.

The design given herewith is plain bodied in the quarters, while the doors are made with square corners. The hind quarter is made with round corners and is cut up in its depth by a belt panel quarter on the top of which the elbow line is formed, and the panel mouldings worked up in the solid.

The corner of the quarter is rounded, the corner piece being got out in the solid stuff to the controlling moulding line, and the quarter panel boxed in level and the moulding planted on. Or the moulding can be worked up in the solid, and the quarter panel gigger-grooved, which is done in high class motor body construction.

The main body line cuts the hind quarter to the following of a coach quarter, the corner moulding running finely into the bottomside. The main elbow line is faintly curved at back and front of body, to harmonize with the plain character of the design. The front seat has an individual elbow, quickened in its curve to blend with the main elbow. The position of the seat is shown in chain line. The doors give ample space for entering and getting out of the body freely. The hind belt panel is carried round the corner and back of body and moulding up as is clearly explained in the drawing.

This design is fitted with a half canopy hood, the front horizontal slab of which is fitted with a universal joint and socket, to take a rod which is fixed to the inside of the slat, and when the head is down, the horizontal slat is slid down the rod and hinges back level with the top of the front slat.

This makes a neat job of the heads folding, while a wider extension is got than can be obtained in a rigidly slatted hood as generally used in motors and half-headed carriages.

The windage light is fitted at the back of the front seat, and is made to hinge in halves. When up in position as in the elevation drawing, the front slab rests upon it, or the light can be fitted with knee jointed hinges by which the top half of the light can be held at any angle desired. There are many methods employed for this object.

The body is flush-sided and straight, the turnunder is, of course, curved as in the section Fig. 2. The plain surfaces require good dressing and framing. There is nothing in a body that paint and varnish show up so readily as bad dressing off at the hands of the body maker, and no part proclaims the cultured and thorough workman like the faultless dressing of the surfaces of a body, be they rounding or flat.

Fig. 1 shows the elevation design in a clear and comprehensive draft, which the experienced body maker can read off at a glance.

Fig. 2 shows the half back section of body, and the cross measurement from elbow point at front pillar to back. The panel line of the belt rail and positions of the mouldings on the round corner, these as divisioned off, are also clearly shown.

Fig. 3 shows the half plan of the body in its structural outline. Every point of width is taken from this section. The points of turnunder are projected from the half section Fig. 2. The position of the corner panel and the moulding are clearly de-

finied. There is nothing difficult about the build of this body; it is all plain framing and paneling.

The draft shows a vastly improved style of body of the so-called torpedo type. There is nothing of the amateurish engineering effort which is the chief characteristic of the torpedo body of to-day, but now fast sliding to the scrap heap of the things that have been.

The design herewith is characterized by excessive plainness, which calls forth a greater art in craftsmanship in build and general finish than those of more elaborate lines where defects can be hid away.

The sizes are: Length of body on chassis, 8 ft. 5 in.; length of body on hind quarter elbow line, 2 ft. 10½ in.; depth of quarter on door line over mouldings, 2 ft. 4½ in.; depth of body rocker, 2 in.; depth of top panel over mouldings, 6 in. width of hind door, 23 in.; depth of ditto, 26 in. Width of front quarter between doors, 28 in.; width of front door, 22 in.; depth of same, 26 in.; width of front quarter pillar, 7 in.; rise of elbow line on front seat, 6 in. Length of seat rail on straight elbow line, 25 in.; full depth of back line to seat line, 21 in. Depth of seat from bottom of body, 16 in.

Width of body over door pillars, 50 in.; across bottom of body, 34 in. Across back of body at elbow point over outside moulding, 42½ inches; over inside moulding, 36 in. Full width of head on body line, 5 ft.; width of horizontal slat, 25½ in.; depth of head from top of elbow moulding to top of front slat, 31½ in.; rise on roof line, 4½ in.

CAB-FRONTED BUGGY.

Cooper's Vehicle Journal, of London, to whom we are indebted for what follows, says: With the revival of the hackney trade, and the demand for good horses, we are met with inquiries for smart two-wheeled vehicles, therefore this working drawing of the low hung cab-fronted buggy, possesses features of design, finish and appointments characteristic of high-class coach-building.

In the design we have embraced in combination the component parts of two well known vehicles, viz., the seat of the Stanhope gig, with its bent rail, panelled and sticked, fixed to the body sides, the fore part of body being finished similar to the front of the well known hansom cab, with its swept breeching bar, shaft attachment, front toe board and dashboard. By this arrangement we have secured the essential qualities of comfort and utility. Equally important with the consideration of keeping the center of gravity low, is the position of the body on the wheels, the seat being fixed, not adjustable. The method of attaching the shafts, has, acting on experience, been studiously thought out, and if the measurements are taken exact, and the lines carefully followed, it will be found to give the correct hang, and little or no weight is on the horse, while any unpleasant "knee motion" is conspicuous by its absence. The lower part of the body being entirely closed in, the heelboard in front being hinged, provides a spacious receptacle for small parcels or luggage.

Fig. 1 is a representation of the side elevation of the body mounted on wheels of a total height, when tired, of 3 ft. 5½ in., the bottom of body being 2 ft. 2 in. above the ground, the shafts being fitted to measure 4 ft. 9 in. long, having a height from the ground under tug 3 ft. 3 in. This, with the back breeching bar, swept 3 in., suitable for a cob 13 hands to 13.2. The width on driving seat is 3 ft. 3 in., this measurement, with 2½ in. throw out of the front seat pillar, gives, when the squabbling is put in, comfortable seating accommodation for two adults. The posi-

tion of the wheel is 1 ft. from the back of body, with an existing space of 6½ in. from the bottom of body, allowing of an even balance of the body and load, in no way interfering with the ingress or egress which is still further facilitated by the curved shape of front toe board. It will be seen that the body sides are not brought down flush with the bottom boards in front, but stand up some 1½ in. above. The drawing of the body is a view looking upon the inside of the offside, showing the constructional details and the necessary ironwork to strengthen same. The shafts with the back breeching stay are shown with the position of tug stops, breeching and kicking staples, also the centre shaft stay and the finish of front toe board. Being drawn to scale, all necessary dimensions can be taken.

Fig. 2 is a view of one half of the front of body, showing the curvature of front pillars, the various widths on seat, with the overhang on body sides, also the lengths of flaps on the iron work and their fixing, also the width across the body on bottom and top of body sides, which measurements are given for easy reference at the end of the description. Fig. 3 is the back elevation of one-half of the body, the lower part of the body sides, showing a sectional view, which gives the thickness of the front boot sides, also the rocker fillets, together with the method of framing up and battening the back panel. The track of the wheels, the position of wing, and the exact length and shape of wing stay, is likewise to be seen in this view. This enables the ironwork to be made while the body is being built.

Fig. 4 represents the half plan of the bottom of body, showing the sweep of the breeching bars and front toe piece, the measurements of the bottom framing, together with the shoulders of the cross bottom bars. It also gives the amount of side cant on the shafts, and their width can be taken at any desired point.

Framing—The framing of the body requires careful and close attention, especially in the framing of the seat. The body sides are cut out to the shape, the edges shot up to the bevel of the sail of sides, the bottom inside edge having screwed to it the ash rocker fillets. These ash pieces are screwed on to show a recess of 1½ in. on the sides. To the rockers the bars back and front are lapped and screwed, the shoulders of the bar being cut to bring the body to the width of 2 ft. 4 in. on bottom, and to a width across the outsides on top of 2 ft. 10 in. The bottom boards are rebated in from the top, grooved and tongued, strengthened by the ordinary strap plating. The hind bar is kept stout at the back, 3 inches. To this the battens are let in, but the top front inside edge is bevelled right off to the thickness of bottom boards. The front of body sides are strengthened by a 3 in. batten, to which the back panel is pinned. The front ends have the swept toeboard rebated in from the front on top of cross bar, the swept breeching that is grooved into the breeching shaft bar covering the joint.

In framing up the seat, which should be finished 1½ inch thick, the end pieces should be at least 9½ in. wide, framed with haunch mortise and tenon, the front rail kept back 2 in., the back rail being kept wider, minus the haunch. The front pillars cut out of the 2 in. plank dressed up to the sweep and gauged to hold up 1¼ in. thick, are shouldered on to the seat and screwed up from the under side, the outside having the inch moulding boxed on and grooved to take the ends of the panel. The bent rail is lapped on to these pillars, the rail got out to

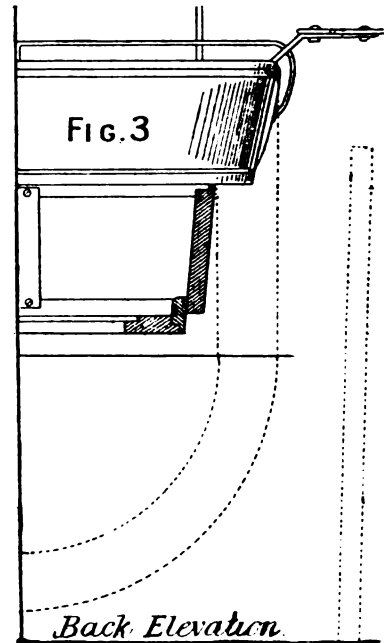

the thickness, the back and sides dressed to the bevel of back and outward inclination of the sides, the two bevels being nicely worked in, care being taken that both corners are alike; the seat having the back corners rounded in a similar manner, proportionate to the rail; both are then grooved with the jigger to take back the panel.

The principal measurements of body follow: Length of body on bottom 3 ft.; length of body side on seat, 1 ft. 7 in.; depth of boot body side, 11 in.; depth of boot body side over all, 12½ in.; depth of seat panel over all, 10½ in.; depth of front toe panel, measured square, 8 in.; height of raised back from top of seat, 1 ft. 6¼ in.; distance of dashboard from front edge of seat, 1 ft. 7½ in.; width of body on bottom, 2 ft. 4 in.; width of body across top of boot sides, 2 ft. 10 in.; width of body across front of seat over all, 3 ft. 3 in.; width of body on top over all of bent

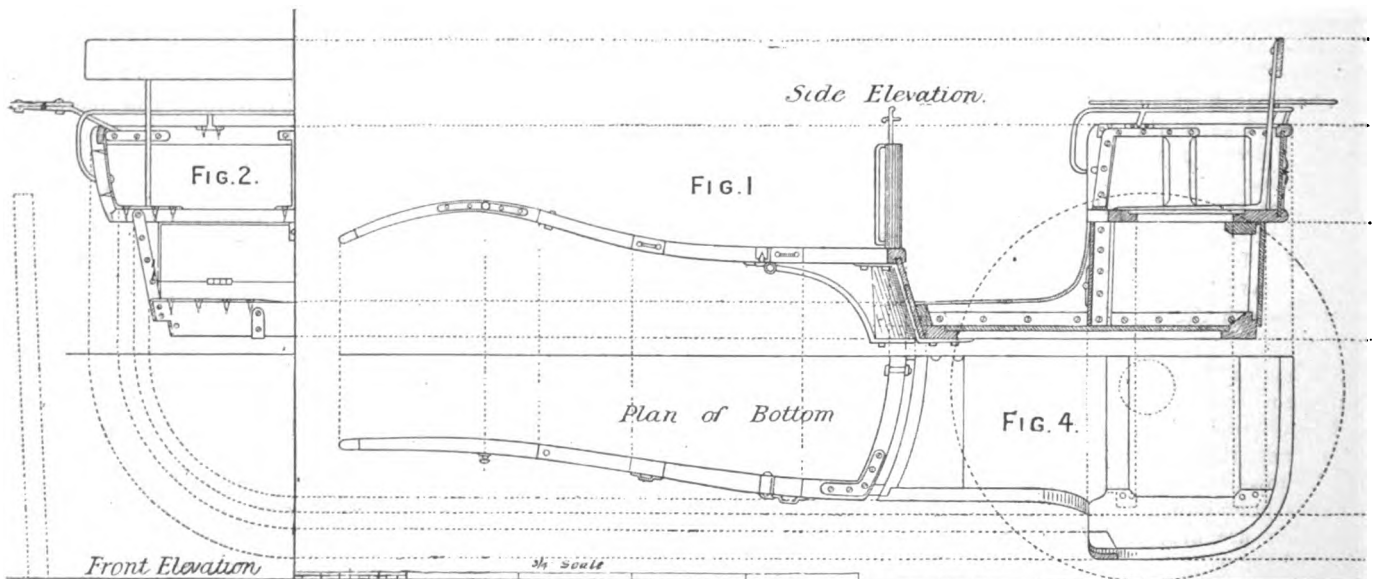

rail, 3 ft. 8 in.; width of seat from back to front, 1 ft. 9 in.; length of shafts from breeching bar, 4 ft. 9 in.; width of shafts at breeching bar, 2 ft. 3 in.; width of shafts at tug stops, 1 ft. 5¼ in.; width of shafts at points, 1 ft. 7 in.; height of shafts under tug stops from ground, 3 ft. 3 in.; height of dash board, 11 in.; height of wheels finished with I. R. tires, 3 ft. 5½ in.; height of bottom of body from ground, 2 ft. 2 in.; centre of axle from back of bottom of body, 1 ft.; bottom of body from top of axle, 6½ in.

BIG JELATONG RUBBER INDUSTRY.

A big rubber company, organized by American capital and now partially owned by English capitalists, has secured tapping rights over all of the government forest reserves in the Federated Malay States. The territory includes about 5,000,000 acres, and the company has obtained the right to tap all jelatong trees on this wide area for a period of ten years, with a renewal privilege for seven years more. This company also holds large rights in South Borneo, in Sarawak, and in the Karimon Islands. They turned out 325,000 pounds of jelatong last year and realized for their recent sales \$1.25 a pound.

On the Karimon Islands, situated a short distance south of Singapore, the company is erecting a \$300,000 factory in addition to the large one now in operation in Sarawak. This factory will handle all the jelatong received from concessions outside of Sarawak. It is claimed that early in 1911, when the mills will be in full operation, they can produce 6,000,000 pounds of jelatong gum, 10,000,000 in 1912, and 12,000,000 in 1913. These are estimates made by those interested in this great enterprise which promises to monopolize the jelatong market.

The shipments of gum jelatong from the Straits Settlements during the past two years have been as follows:

| | 1908. Tons. | 1909. Tons. |
|---------------------------|----------------|----------------|
| United States | 3,983 | 12,824 |
| United Kingdom | 647 | 1,009 |
| Continent of Europe | 1,427 | 5,093 |
| Total | 6,057 | 18,926 |

VIRGINIA AND NORTH CAROLINA DEALERS' CONVENTION.

Thursday and Friday, November 17 and 18, are the dates for the second annual convention of the Virginia and North Carolina Retail Implement, Vehicle and Machinery Dealers' Association convention at Norfolk, Va. The association does not plan a convention where dealers can listen only, but they do plan a convention where free speech will be the order, and all dealers can be heard. Meetings will be for dealers only, and so dealers can be assured that they can come and talk plain, one to another, and then, by combined action, bring results that will make dealing more pleasant and profitable. J. D. Barkley, head of the Sledge & Barkley Co., Inc., Lawrenceville, Va., is the president.

GOOD BUSINESS.

Managers of the vehicle manufacturing plants in Columbus, Ohio, are now closing up their business for the fiscal year and all of them report having made good profits in the last twelve months. The last two or three years have been rather hard on many plants, and as a result there are not now nearly as many buggy and carriage manufacturers in the country to divide the business as there was, with the result that the plants which survived are now getting good orders. Especially from the South are orders for vehicles good, and all the vehicle companies are looking forward to an excellent business the coming year.

DESIGN FOR UPHOLSTERING A LIMOUSINE LANDAULETTE.

A richly designed and highly finished car calls for a correspondingly luxurious style and finish in its upholstery. For this work we are bounded by none of the restrictions of usage, but

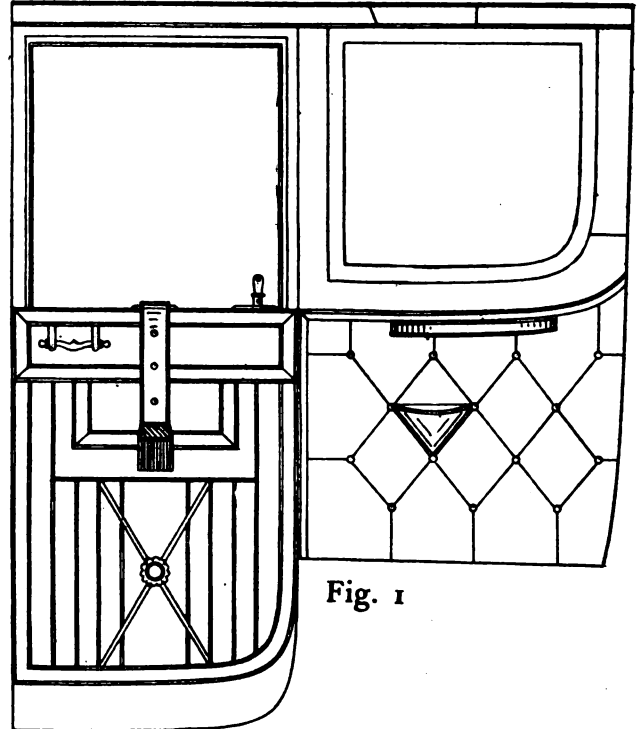

Fig. 1

left free to carve out and design in outline and general finish as the conditions under which we produce dictate.

The design we show in this issue for trimming a limousine landaulette is most suitable to this style of car, being artistic

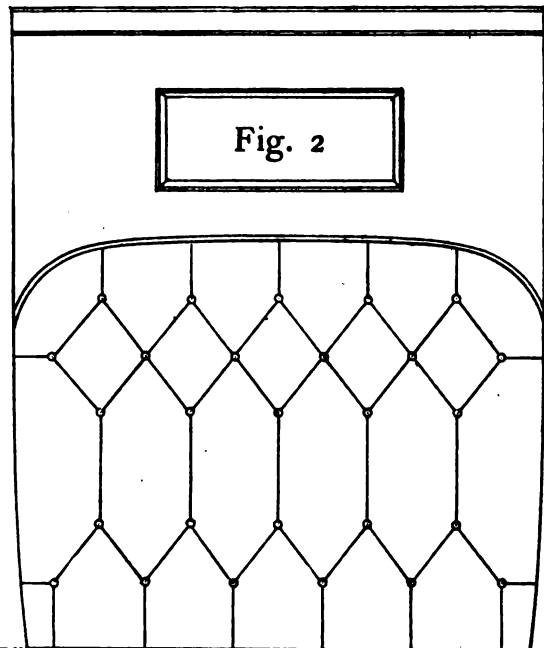

Fig. 2

without over elaboration, and comfortable without encroaching upon seating room, while the distance from the front of seat to front of body gives ample space for leg room, which is so necessary in motoring long distances.

The seat is made portable and built up in framed coil springs. These cushions are a vast improvement upon the all-hair cushion, and yield to the swaying pressure of the occupant's body in the car's motion with a restful and resistive ease, thus

rendering an additional comfort, and responsive to the springs and pneumatic tires in rising and falling into the irregular surface of roads when speed is set up.

The design given here is of diamond and plain panel working, the surface being artistic and most pleasing in its enrichment of the car's interior.

Fig. 1 shows the hind bottom quarter, the top quarter and glass frame, and the door in its full dressing and squabbing. The glass frame of the hind top quarter drops down into the body quarter. The woodwork of the pillars can be covered with cloth, and edged with lace, or it can be finished in painting only, as also can the door pillars off by the garnish rail.

The diamonding of the quarter squab is of larger dimensions

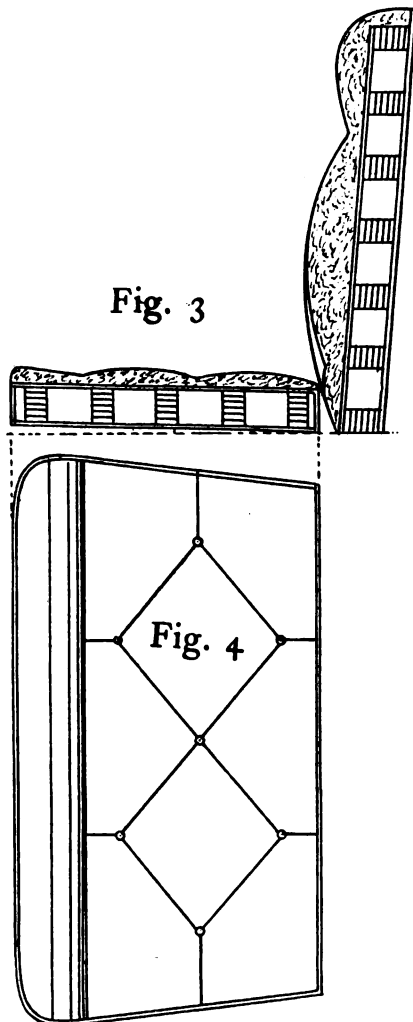

than is generally worked, but in a motor car conditions are different to a brougham or similar horse-drawn carriage, in which dust cannot so readily find a lodgment. Hence, in motor trimming, a plain style of surfacing, and large figuring, are the most favorable for keeping dust from gathering in the lines of the upholstery.

The quarter is fitted with elbow rests projecting out from the squab; and plain laced or piped round the edgings, also round the elbow squabbing, a pocket is worked on the squab, the width of the diamond figure as shown in the drawing. This is necessary for the holding of visiting cards, and other light necessities.

The design of squabbing for the door is both plain and in a degree ornate. The garnish rail is plain, panelled and margined with a narrow broad lace. A plain tag figuring is the most suitable. Lace is a nicer contrast to the morocco, though, of course, morocco edging is widely used; but it gives a sameness to the squabbing, which lace relieves. The panel cloth is finely stuffed to a rounding surface tapering into the edges of the lace.

The pocket is made of morocco, but plain, and the flap to

harmonize. The edging of the flap is made to match the garnish rail panelling. The squabbing is in plain columns, with center panel dressed with rosette center, and diagonal cording, which gives a sombre setting to the squab's finish.

Round the edges of the door narrow broad lace is used, seaming lace on the edge, and the broad lace worked into the side like pasting lace. This makes a nice and smart finish to the squabbing.

Fig. 2 shows the back squab and its lines of setting out in the figuring, which is of full diamonding on the top figure and column diamonding in the centre. The side pieces are finished off on the center points of the figures, so as to complete these sidings to the squab's dimensions. The top back head leather quarter with back light is also shown in this figure.

Fig. 3 shows the end section of the back squab, with coil spring frame, and layer of stuffing and the breast swell of the squab. The end section of the seat cushion is also shown with the coil spring frame. The stuffing is kept as light as possible, but sufficient to prevent the action of the springs being felt. The frame in the first place is covered with a strong, flexible material of the linen fibre, and the squabbing finished individually.

Fig. 4 shows the top surface of the seat cushion, and its figuring. The front part of the seat is plain rolled, standing up so as to form a ledge for the thighs of the body to rest on, and thus support the body in a restful position effectively.

In the upholstering of motor cars advancing thought is always tunneling to achieve fresh roots, from which to spring new forms of decorative figuring, to harmonize with the character and design of the car upholstered.

WAGON MAKERS CONFER.

The National Wagon Manufacturers' Association met in Chicago October 13 for the purpose of considering manufacturing and trade conditions. There was a large attendance. Reports made by manufacturers show that the trade is making satisfactory progress. The sales of 1910 show a considerable increase over 1909. The past few months have been normal. Prices have been maintained because the cost of production has left no alternative.

The condition of timber supply suitable for wagons still is a matter of concern to the manufacturers. It is said that one class of wood used largely for felloes and grown principally in northern Texas and southern Oklahoma is practically exhausted as a commercial wood.

The investigation which has been going on relative to the standardization of hubs has resulted in placing the matter in the hands of a special committee. The plan is favored by both wagon and hub manufacturers.

The association added to its list of rules, which are mutually adopted by producers and consumers of wagon stock, one covering the various kinds of lumber used for beds and boxes.

A special committee was appointed to present to the manufacturers of iron and steel a request that quotations on these materials be made f.o.b mills instead of Pittsburg, as the quotations are now made.

The association has recommended the discontinuance of the manufacture of wagons with bolsters measuring 44 inches between standards. The universal adoption of the 42-inch standard is recommended.

The report of the cost educational work undertaken by the manufacturers, jobbers and dealers' associations shows gratifying results and the association recommended continued support of the movement and co-operation with others taking part therein.

Notwithstanding the fact that the wagon manufacturers' association is one of the strongest industrial organizations in the country, serving any specific line, the proposed merging of the different implement and vehicle organizations into one powerful association appealed to the meeting and a special committee was appointed to act in the matter.

Carriage and Automobile Painting

TESTING VARNISH.

The subject of varnish has so many interesting phases that its treatment commands interested attention even when a particular phase of the manipulation is not primarily of importance to the painter from a practical view point. W. G. Scott, in *Drugs, Oils and Paints*, writes engagingly on the subject of testing varnish, and a part of his paper will afford good reading to our subscribers.

The only absolute test for the durability of an exterior varnish is a practical weather test.

Railway and carriage body varnishes are expected to retain a certain amount of lustre after an exposure of from twelve to fifteen months, and to protect the under coats for a much longer period. Cheap agricultural implement varnishes are expected to show some lustre at the expiration of five or six months' exposure, and to protect the under coat for a year or more.

In addition to the durability or wearing quality, there are other points to be considered, such as ease of working, flowing, leveling, fulness, lustre, viscosity and body, time of drying, hardness and toughness, imperviousness to water, color density, etc.

In varnish factories, where samples are to be matched and the quality determined quickly, a series of short tests are made to ascertain the essential features and properties of the varnish in question. Nearly all varnish factories have, in addition to a chemical laboratory, a "Testing Department," where samples are matched for color, body, working quality, time of drying, etc. Not only the samples received, but also every tank of varnish made, is subjected to such a test, and a report made; thus it is possible to match most of the samples from the material in tank. Cards prepared for the purpose are used for reporting these tests and are carefully filed for reference.

In the testing department everything is compared with the "standard." The color, body, drying and other features are tested with the standard, which may be a body, rubbing, baking or other grade of varnish.

Color is generally determined first by comparison with the standard in small glass test tubes, the color being reported as extra light, light, medium, dark, or extra dark. The color is again noted after the varnish has been applied and allowed to dry.

Body is determined by means of test tubes used for the color test, the sample and standard being turned upside down, and the time noted for the rise of the air bubble.

Drying, flowing, levelling and ease of working are features determined when the test boards are coated.

Experience has shown some very peculiar facts in connection with this test; for instance, whereas it is customary to make drying tests of Japan driers on glass to determine their hardness, toughness, etc., this is not a proper method for varnish. Varnish must be applied on a surface to which it will adhere in order to determine its drying properties, hardness, etc. Natural wood, properly filled, either with a silex wood filler or a good surfacer, and finished smooth, is the ideal foundation for a practical test of the working properties of a varnish. Oak, ash, maple, birch, mahogany, sycamore, and hard pine are the woods generally used for such tests. Next to natural wood comes well-seasoned pine coated with primer, a surface obtained by means of "rough stuff" or similar material, and a final coat of flat color applied. Manilla or other strong papers, properly sized, oiled or treated with shellac, are also used, but are not looked upon with much favor.

It is obvious that the undercoats should be thoroughly dry before applying the varnish to be tested, otherwise the latter

will sink into the undercoat and lose its lustre. The proper temperature of a varnish room, and the one at which drying tests should be made is 70 deg. F. Humidity is seldom taken into account, although it is an important factor and will sometimes be considered. Dry air currents hasten the drying of varnish.

The operator or tester, having his sample boards prepared, first pours a small quantity of the sample varnish into a clean cup, working it into his brush, and is almost sure at this point to note the odor, whether turpentine or benzine, or a mixture of the two. Some operators also claim to be able to distinguish the smell of wood oil, but this is rather difficult unless the material is an all wood oil varnish.

The sample varnish is now applied to the board and laid off in the regular way, crossing and re-crossing. Usually, four crosses are sufficient to determine the leveling property, but occasionally the work is crossed until the varnish "sets up" (show brush marks) in order to determine the limit of its flow. After being coated with the varnish the board is placed in a vertical position and allowed to dry. Runs and sags are noted, some judgment being required to decide whether such defects are due to the varnish or in part to the method of application. The time in which the varnish sets free from dust and the number of hours required for it to harden sufficiently to withstand the print of the finger are noted, the latter point being considered the drying time of the material. The determination of hardness and toughness can only be obtained by comparison with known standards, which are allowed to dry and harden for the same length of time. Some varnishes will harden to the verge of brittleness in three or four days, while others require months to reach the same degree of hardness.

PRIMING, FILLING AND RUBBING DOWN.

To produce the best work, too much attention cannot be paid to the priming or foundation coats. All of these priming paints should be mixed to one set formula. Quantities should be measured, not thrown in in a hap-hazard manner. All panel work should be examined carefully previous to applying the priming, in order to be sure that all is in a fit state to receive this initial coat. The materials required for this primer should consist of white lead, raw linseed oil and turpentine. We have other preparations that are warranted to take the place of these, but the old formula still holds the lead, and is likely to continue to hold it, spite of the many other preparations that are forced under our notice.

No substitute has that dense compact body that white lead possesses. White lead is a carbonate of lead, and one of the most useful pigments the painter handles. It is produced by treating metallic lead so as to facilitate the absorption of carbonic acid. This metallic lead is placed in earthenware pots containing acetic acid. The pots are built up in tiers. They are then surrounded with horse manure or other heat-producing bodies, the heat from which volatilizes the acid and this, in conjunction with the air, oxidizes the lead. The acetic acid changes this oxide into acetate of lead, this again being converted into carbonate by the carbonic acid. It is then removed, ground in raw oil, and packed in barrels or iron pots, ready for sale.

Lead is frequently adulterated. A simple test, not scientifically correct, but sufficiently so for the paint shop, is to take a piece of flat steel. Make this red hot, place a piece of white lead on it, and allow it to cool. If genuine the lead will have the appearance of a light clay, but if adulterated, will take on the appearance of a mass of fine crystals, more or less according to the extent of the adulteration.

Our next friend is linseed oil, which is made from the flax

seed. The seed is first put through a screen, to remove any foreign matter. It is crushed to a pulp, and then passed into steam boilers and thoroughly cooked. After this it is made into cakes, and passed through hydraulic presses, which squeeze the oil out. This latter is run off into vats, and is allowed to settle for a few days, after which it is filtered twice, and finally passes into the storage tanks. Of the two oils, raw and boiled, the former is the most suitable for carriage painting. It is lighter in color and not so liable to blister. Boiled oil is of a more gummy nature and for panel work is very unsuitable.

Turpentine is a real live force in the paint shop. Pure turpentine is in color water white. The most noted adulterants are benzine and petroleum. The most conclusive test as to purity is made with the hydrometer, but painters do not carry these in their kit, so we are forced to again fall back on the humble shop test. Pure turpentine, if poured on a sheet of white paper, should evaporate, leaving no stain behind. But there are substitutes that will stand this test, so the painter is forced into the position of proving its purity by actual working conditions.

For the priming coats the three materials named, viz., white lead, linseed oil and turpentine in combination, stand supreme as a foundation on which to build the paint structure.

For the priming coat, a rather slow drying coat is necessary, to enable the oil to sink well into the minute cells of which the wood is composed. It must also be elastic. Use lead sparingly in this coat, just sufficient to give the liquids a tint of white.

No. 1 primer.—Equal parts of raw oil and turpentine, one pound of white lead to one and a half pints of liquid. To this add one teaspoonful of Japan gold size. Allow to stand two days.

No. 2—Equal parts of raw oil and turpentine, a third hard drying varnish, half a pound of lead to each pint of liquid. Allow to stand two days.

No. 3.—One-third raw oil, two-thirds turps, one pound lead; to each pint of liquid add one pound of white lead. Add a small amount of patent dryers. Allow to stand one day.

All these primers can be tinted with vegetable black. This however, does not add to the durability of the work. By leaving all coloring matter out with the first and second coats of priming, you are better enabled to keep the work clean.

The second coat of priming should have more lead added, and the amount of oil reduced, as the first coat mixed as directed has all the elasticity required. For second coat lead we require a full, generous-bodied paint, mixed as follows: One-third raw oil, two-thirds turpentine. Add sufficient lead to make an easy working mixture. To this add one tablespoonful of gold size to one pint of paint. Apply these coats with a bristle brush, cross-brushing well, leaving all nicely dressed. This should stand two days, when the stopping should be attended to. For body stopping take keg lead one-fourth, dry lead three-fourths. Mix this into a stiff paste with best gold size. This must be well beaten with a wooden mallet to ensure it being tough and elastic. For work that is subject to a time limit, dispense with the keg lead, as this contains oil, and under a time limit should be discarded.

Take the body and seat in hand, and give a light rub with sandpaper. Dust off and carefully stop all screw and brad holes, leaving as little stopping as possible on the surface of panels. Screw holes, and other bad places should receive a second stopping before the filling coats are applied.

Most painters have in the past been in the habit of mixing their own filling, but within the last few years many of the firms have stocked a really reliable filler, but for those who prefer the shop-made filling two formulas are here given. The latter one is for quick work:

No. 1.—Add half-pound keg lead to two pounds of dry filling. Mix to a stiff paste in equal parts rubbing varnish and best gold size. Thin to a working consistency with turps. Apply one coat each day.

No. 2.—To three pounds of dry filling add half a pound of keg lead. Mix to a paste in one-third rubbing varnish, two-

thirds quick gold size. Thin with turps. Apply two coats per day.

All filling should be ground in the mill. This gives it a denser body, and one that will rub to a much finer surface. Apply with a bristle brush. No. 1 filler should stand four days after the last coat is applied before rubbing out. No. 2 should stand two days. During this interval apply a guide coat. Make this with any of the cheap reds, mixed in a third gold size and two-thirds turps. From four to six coats of filling are necessary, which must be left to the painter's discretion.

The wheels and carriage should receive one coat of priming before passing on to the smith. When returned they should be cleaned up, and all iron work should receive one coat of lead, mixed as directed for the second coat. On the body the following day a second coat may be applied all over, after which it will require stopping.

Another method is to use equal parts whiting and lead. Another is called "rub lead," and is made with dry white lead mixed with three-fifths raw oil, one-fifth gold size, and the same quantity of turps. Keep this mass fairly thick, and run through the mill. Add coloring matter to suit. Apply this with a stiff brush and allow to stand until tacky, then take the bare hand and rub well into the grain. This rubs to a nice smooth finish, but both of these methods are dirty in practice. In the former case you inhale the dust from the sanding; in the latter you are working up a fair proposition for lead poisoning. For these reasons they are methods which should be dropped by every man who has any regard for his health.

A method pursued by the writer for many years with success to take the best gilders' whiting, mixed with two-thirds best black Japan and one-third raw oil (in very hot weather add more oil). This should be well beaten. Sand-paper down the gear, dust off and putty up the grain, joints, etc., all over. Allow a little more time in which to dress up, as you will eventually save it in the sandpapering, which is necessary when using either of the two formulas. All that is necessary is a light rub with curled hair or half-worn paper.

A good putty for white ground is made from equal parts dry and keg lead, mixed in equal parts raw oil and gold size. For a sharper putty take dry lead and whiting, equal parts, mixed in raw oil, adding a dash of gold size to harden.

All putty and stopping should be kept in a jar with a lid, and should be covered with water, care being taken in all cases to see that the water is thoroughly worked out when using. This is an easy matter with putty, but with stopping a better plan is to press.—Australian Coachbuilder.

REPAINTING IN SMALL SHOPS.

All small shops should get into the automobile repair and repainting business. The time will come when you will be fixing them up like old buggies, and have a few old ones on hand to trade and sell. Charge good prices for your work. Keep up with city prices. Do good work and stick to it—then get yourself a good painter. Do not try to do the painting yourself if you intend to stay in the business. If you are not a painter do not try to paint a job—you will chase away trade. Do not let your painter try to paint your work without unhooking the job. I have seen this done many times. Unhook them, number them, start your job right. I have seen painting done in small shops that did not even clean off the grease, and never took the wheels off. Do you imagine that your customers do not see that? Next time they want a job of painting they will take it to another shop.

Wash and clean your jobs after you have dissembled them. Be sure to clean off all grease. Do not take seats or dashes off on a cheap job; on a good job take dash off. Take wheels off gears, and have a good wheel jack handy, also make a gear rack to put your gears on while working on them. You can work so much better this way in a small shop, instead of the old way of leaving wheels on the gear.

After you get your painter get in your paint stock. Get stock

so you can paint a cheap or a good job. Stock with all kinds of japan colors, clear rubbing, two kinds quick and slow drying, two kinds of black rubbing, the regular kind and the solid-covering color varnish; two kinds of gear for cheap and good work. For body finishing get a good kind that will dry hard in a reasonable time, as your customers may want the work the next day after you finish it, or it may be a week before it is taken out. Aim to have a good body-finishing varnish—it's the "whole cheese." Lots of these cheap rubbing varnishes would go "ker-plunk" if they did not have some maker's good body finishing before or in front. Get a keg of good white lead, a good lamp black—not the grainy kind.

Have raw linseed oil for carriage painting, and straight turpentine. Always get the best brushes you can buy, they pay best in the long run. I have been in small shops where they did not know what rough stuff was for. Always get a good brand of roughstuff; it is like putty; you can't do much carriage painting without it.

I will tell you how to mix the first coat for bodies, gears and chassis in my next, also the following coats, and the quickest way for the money; and the work will look well.

W. A. RIGGLEMAN.

PAINTING TAXICABS.

The Commercial Motor has been looking about on London's streets and finds some noteworthy changes in painting cab bodies, which the writer describes.

Brilliance of paintwork and luxurious furnishing of coachwork, indications of which change were noted as a welcome feature—from the standpoint of a brightening of the London streets—ensure for the newcomer the preference of the hirer. The older and more soberly-garbed machines suffer—for a time. To paint a cab-body bright green may, in the first place, cost little more than to paint it in lead color; it is upon the question of maintenance of the rival colors that owners will do well to ponder. There is such a craze at the present time to compete satisfactorily, by reason of luxurious equipment, that certain owners of taxicab fleets seem to be unmindful of the net economical result of sky-green panels and of genuine leather trimmings. The outfits of many of the latest motorcabs are far too lavish for the purpose, and their colors, conspicuous for advertisement purposes, may, in some cases, be the cause of equally-conspicuous maintenance charges in the annual accounts. The hirer temporarily profits by lavish outfitting, but the owner eventually has to "pay the piper" in respect of increased maintenance charges. We, of course, lay down no hard-and-fast rule that only the inconspicuous colors are the economical ones. The lakes, for instance, are the most expensive, and yet they wear well; some of the lighter shades also cost little to maintain. We would, however, plead that, in the careful selection of paintwork, owners should not be unmindful of maintenance standards and charges.

THE ALL-ROUND MECHANIC.

In this age of specialists we frequently hear it remarked that the old all-round man is a thing of the past, and that Handy Andy is no longer appreciated. Yet upon inquiry it is quite common to find some good all-round mechanic who is thought more of and turned to more frequently than any man in the place, and is considered almost indispensable. So, if the all-round man passes away entirely it will be because the old ones have died out and the young ones have not qualified, rather than because there is no call for such a man.

LINCOLN AND LAFAYETTE.

The carriage given by the government to Lafayette in 1824, and the carriage that Lincoln rode in just previous to his assassination, were spot light features at the Studebaker exhibit in the Dealers' Show in Chicago.

THE HICKORY SUPPLY.

Hickory once grew in commercial quantities from Connecticut, New York and southern Michigan south to Florida and west to Illinois, Missouri, Oklahoma, and eastern Texas. In this region it formed, perhaps, one-fortieth of the total hardwood stand. Measurements of 2,000 acres in the southern Appalachians, for instance, showed that it formed 5.1 per cent of the trees over 10 inches in diameter. The percentage was greatest in the Ohio and lower Mississippi valleys.

The original supply is now approaching exhaustion. East of the Alleghenies and north of the Potomac it has disappeared almost entirely. West of the Alleghenies and north of the Ohio only a few scattered remnants are left, and the bulk of the supply lies south of the Ohio River. Most of the northern manufacturers get their supplies from the South; all of the larger operations are there and competition is very keen. The whole hickory-producing territory has been covered by the timber buyers, and already some of the larger companies are working over their old cuttings, taking material which had been rejected ten or fifteen years ago. In only a few years, probably not more than ten, the conditions of to-day in southern Indiana and Ohio will be duplicated in the South. The large timber will be scattered and hard to get and the second growth will become the main source of supply.

In the South, as well as in the North, hickory, like oak, ash and tulip with which it is generally associated, is owned mainly in small holdings. It grows best on fertile soils in a strictly temperate climate, and is most prominent in the agricultural regions of Ohio, Indiana, western Kentucky, and Tennessee. Throughout this region the forests have now, for the most part, been cleared away to make room for agriculture. Hickory is, and probably will continue to be, a tree of the farmer's woodlot, though there are a few large holdings in the river bottoms of the lower Mississippi Valley and in the Southern Appalachians. In all of these, however, the hickory grows in mixture with other species and usually occupies a subordinate position in the stand. None of the larger holdings and, in fact, few of the smaller ones are valuable chiefly for the hickory which they contain. Because of this hickory users have found it impracticable to buy up and hold timber land for the production of hickory.

Hickory is cut either by small portable mills, which saw only hickory or hickory and oak, and move on when the supply is exhausted, or in the case of spokes and handles or round bolts, cut by farmers and contractors who rive out the billets in the woods, or ship the round bolts to some central stationary mill.

The portable mill commonly cuts material for rims, poles, and shafts. It requires much skill to work up the hickory properly, so the mills are generally run by men who have made it a life work. These small mills cut the wood into rough strips to be shipped to larger stationary mills for finishing. The cost for logging and lumbering hickory is greater than that for any other common native hardwood. It takes much time and trouble to locate and buy it because it can rarely be secured in large lots; because of the widely scattered supply the mill must be removed a great many times or the logs brought long distances; the wood is hard to cut and heavy to haul, and there is a great amount of waste at the mill. In addition, rough stock must always be shipped green, and that makes high freight bills. Altogether, it often costs twice as much to get hickory to the factory as it does oak, yet hickory plank, cut in connection with other operations, brings comparatively low prices because it is apt to be cross-grained and has a tendency to check and split when it is not worked up immediately.

Spoke billets are commonly rived. Rived billets are preferred by the spoke makers and bring the best prices, but riving is wasteful. Skilled hands may get as many rived spokes out of a given bolt as could be obtained by sawing, but fewer cuts are taken from the tree and the material which will not make spokes is never utilized, except occasionally for firewood.

There is an additional waste because heartwood and birdpecked wood, which would be used if it were at the mill, is generally left in the woods. The price of rived spoke billets in Memphis, Tenn., is \$14 per 1,000 billets for the white and \$9 for the red. In southern Indiana the prices are \$22 and \$14. Sawed billets are usually about one-third less. Much waste is avoided when the tree is cut into round bolts of the proper length and these are hauled or shipped to the mill to be sawed. Such bolts bring from \$10 to \$12 in Ohio and Indiana. A cord of hickory will yield about 700 rived spoke billets, or 900 sawed ones, or from 250 to 300 handle blanks.

Next to black walnut, hickory, according to the census returns, is the most valuable of important American woods. This high value is due in part to the inclusion of the prices of special stock and to the greater cost of lumbering. Stumpage prices, however, are, in most places, still comparatively low, generally about the same as those of oak. In the South the common price is from \$2 to \$5 per thousand feet. In northern Ohio, according to the location, \$15 to \$25 is paid, and in eastern Pennsylvania, Maryland and Virginia, \$15 to \$35 is common. Oak in these more settled districts, perhaps, 30 per cent less.

Except where hickory bolts are actually piled and sold, the crudest of methods are used for measuring hickory logs and bolts. Logs over 10 inches in diameter are usually scaled by the well-known Doyle rule, which, in spite of its wide popularity, is one of the most inaccurate of all log rules. It gives values which are too high for large logs and very much too low for small logs. On a conservative estimate based upon a number of mill studies, 10-inch logs show an overrun of as much as 70 per cent in the amount of rough lumber which they will yield; 15-inch logs of 40 per cent; 20-inch logs of 20 per cent; while logs more than 30 inches in diameter show an underrun. This is particularly unfair in the case of hickory because the sizes are usually small, and in an average lot of hickory logs there will be an overrun of 40 per cent or even more. Sometimes the Scribner rule is used, but even it is unsatisfactory and fails to give the smaller sizes their just values. The great injustice exists in the case of short bolts and logs under 10 inches in diameter. Hickory butts under 10 inches in diameter are commonly sold by the linear foot. In northern Ohio they bring 5 cents per linear foot, regardless of diameter. In southern Ohio a sliding scale is commonly used by which the number of cents paid per linear foot is 2 less than the number of inches in the diameter of the log at the small end inside the bark. This is better than taking no account of the diameter, but it is far from correct. For example, a 10-inch log contains nearly three times as much material as a 6 inch log, yet the price is only twice as great; a 12-inch log contains four times as much material as a 6-inch log, but the price is only two and a half times as much.

Handle and spoke bolts are commonly sold by the cord; but since it is often inconvenient to pile the wood in order to measure it, various other devices are resorted to. One common method is to measure the diameters of the 30-inch bolts at the small end inside the bark and add these diameters together until a total of 32 feet is reached. This is called a cord. Two classes are generally made—bolts between 6 and 8 inches in diameter and those over 8 inches. Some difference is made in the price, but it is never enough. In one place, for instance, the first class brought \$5 per cord and the second class \$7; yet, even if the average diameter of the two classes had been 7 and 9 inches, the ratio should have been 5 to 8. As a matter of fact the average diameter of the second class was considerably over 9 inches, and the difference should, therefore, be much greater.

In some cases, an estimate is made of the number of billets which the bolts contain, and they are bought at so much per thousand.

The result of present methods is that highest values are given to small sizes on the one hand and to the largest on the other, while the very sizes which are most to be desired and which in the future should be most profitable, the logs and bolts from 9

to fifteen inches in diameter, are given the lowest values, sometimes by as much as 25 per cent or more.

The amount of merchantable hickory wasted each year may be conservatively estimated at 40 per cent of the total cut. It consists both of waste in the woods and waste at the mill.

The greater waste is in the woods and is due chiefly to unnecessary restrictions against heartwood and birdpecked wood. Millions of feet of good hickory are cut each year and left in the woods because of the presence of a few birdpecks, or the large proportion of heartwood makes it unprofitable to market it. Such waste is especially great where spoke billets are rived out in the woods and only white billets are taken, because the red billets bring little more than half as much as the white. Another source of waste comes from the upper cuts of the tree in favor of that from the lower cuts. This is due not alone to the knottier character of the upper logs, but also to the prevalent opinion that the wood is considerably inferior to that from the lower cuts. The practice of cutting high stumps prevalent in the South is also very wasteful. It is claimed that the difficulty of sawing out with the grain makes it unprofitable to cut below the flare of the butt; therefore small trees are generally cut more than a foot above the ground and large trees more than 2 feet. Some firms, however, cut low stumps and consider that the greater width of the sap and the greater toughness of the wood in the butt is a sufficient offset to the difficulty of sawing. If the average stump height—at least 2 feet—were reduced only 8 inches, as would easily be possible, there would be saved as much as 10,000,000 board feet annually on the total cut.

A somewhat unavoidable waste arises from the taking out of special products. The pole and shaft or the sucker-rod makers leave a lot of stuff in the woods which would make good handles or spokes, while the spoke or handle makers use up a great deal of material which should really be put into poles, shafts, rims, or sucker rods. Even where economy is attempted and spoke billets or handle blanks are cut in connection with poles, shafts or rims, it is often difficult to dispose of the by-product, and it often happens that for lack of a market thousands of feet of hickory are destroyed by insects.

Much of the waste at the mill is due to the discrimination against the heartwood and birdpecked material. Another source is the practice of cutting spoke billets and rim and pole and shaft strips unnecessarily long. This is especially true of spoke billets, which are cut into a uniform length of 30 inches, whereas the spoke lengths range from 18 to 24 inches.

In addition to the waste of merchantable material, in lumbering much promising young growth is used for skids, is swamped out, and is broken by falling trees. This loss is hard to estimate, but it is very great, and will seriously affect the future supply.

THROUGH ENGLISH EYES.

I have just returned from a visit to Detroit in connection with the convention of the Society of Automobile Engineers, says the U. S. correspondent of The Commercial Motor, and have had my first opportunity of examining some of the big factories. That any industry should be carried on under such conditions is remarkable. Factories turning out 140 to 160 cars a day sound like the language of hyperbole; nevertheless, such as at present the case. It is quite evident, however, that over-production has already set in in the case of some of the cheaper touring cars, and one firm (not in Detroit) has, it is reported, 2,000 of last years model cars on its hands, which cars are now unsaleable. It is to be hoped that this example will check some of the speculative business which has been carried on during the past year. As I had occasion to point out some time ago, many makers have already seen the advantage of being prepared with a commercial vehicle of some kind, and almost all are now entering this field in earnest—some with reasonably good models, others without this asset, and the next motor show at New York should bring out some interesting things.

C. H. A. T. CONVENTION.

The Carriage, Harness and Accessory Travelers' Association held its twentieth annual meeting in New York in October.

Secretary Nelson sent notices of a meeting in New York City, October 17, which was to be a Board of Directors' meeting with all the members invited, who would come, and it was thought a later meeting would be held in January.

The result of the meeting in attendance and enthusiasm was such that the regular annual meeting was decided on, and plans were laid for a big time at Atlantic City, next September, at the time that the C. B. N. A. meets.

President John F. Galvin called the convention to order. He said that while it was the custom for the retiring president to



George W. Huston, President, C. H. A. T.

make an elaborate address, he preferred talking as one traveler to another, and then proceeded to renew the history of the association and the good it had done.

"I have never had sympathy or tolerance for the traveler who would ask, 'of what good would membership in the C. H. A. T. be to me,' for the record of the years show that the C. H. A. T. has performed work that is of the greatest value to its members, and he who withholds membership is the one who suffers the loss.

"Association brings men together to forget that they are competitors, and the development of the social side has eased the commercial path of many men who as members of the C. H. A. T. have made remarkable success in their field of work.

"The roll of membership in the C. H. A. T. is an effective answer to the man who does not belong and who asks about the benefits.

"I urge that more attention be paid to the employment bureau of the association to the end that manufacturers will with confidence communicate their needs to our secretary and he in turn be able to give reply promptly so that employer and employee can be brought together. This can be accomplished through the friendly aid of the trade press in advising the trade that our employment bureau is a live force and that we are prepared to serve our members with a mutual regard for both sides.

"The C. H. A. T. should also stand as a force for good on the side of all great trade questions, for in this day the traveler is in truth the representative of his firm and their policies, and every traveler should be not only posted but an active worker for all that tends to better conditions in the trade.

"The automobile has come to our trade and is a part of it.

Our membership is engaged in selling accessories to the automobile manufacturers, and this question as affecting the horse drawn vehicle is one that merits the close study of all.

"I am pleased to report that the membership is in good shape. We have 268 of the best salesmen in the line who carry the receipted card of the C. H. A. T. Some there are who forget to remit, and to such I appeal to heed the request of our secretary-treasurer.

"I have appreciated the honor conferred on me by electing me president of this organization, and while my efforts have been weak, I assure you all that the aims and objects of the C. H. A. T. are dear to me, and in retiring from the office I pledge you that my interest shall not cease, and as we enter a new year, facing the future, let the past spur us on to make this organization larger, stronger and of the greatest good to all who are members. I thank you again."

Charles Hayes, chairman of the Board of Directors, made the interesting report of the year's work.

Charles M. Fellows, one of the charter members, was transferred from the active list to honorary membership. Mr. Fellows is the manager of the Milburn Wagon Co., at Albany, N. Y.

George Huston, president of the Spokesman Publishing Co., Cincinnati, Ohio, was elected president of the C. H. A. T. for the ensuing year. The election was unanimous. Jesse L. Nelson was elected secretary-treasurer.

It was decided that the secretary should appoint vice-presidents representing each State.

On motion of E. A. McGrew, the Board of Directors were requested to name Atlantic City, N. J., and the time, the Wednesday night of C. B. N. A. convention week as the time and place for holding the 1911 convention.

An aggressive campaign for new members will at once be made. Members paying dues now will be entitled to the entertainment at Atlantic City next year. A dollar will be well invested by sending it to Secretary Jesse L. Nelson, care of The Barnat-Johnston Auto Supply Co., Columbus, O.

President Galvin invited the members to be his guests at the close of the meeting, and every member present enjoyed the same to the full limit.

FINE INTERNATIONAL MEET.

Just previous to the assembling of the carriage builders in convention in this country there was an important international meeting abroad at Brussels, comprising the following associations: Institute of British Carriage Manufacturers, Chambres Syndicales de Carrosserie de France, also of Belgium and Holland.

The reception committee was composed of the following well known gentlemen: M. le Comte Jacques de Liedekerke, president de la Chambre de l'Automobile; M. Victor Snutzel, president d'Honneur de la Chambre Syndicale de la Carrosserie; M. Emile D'Ieteren, president de la Chambre Syndicale de la Carrosserie d'Automobiles; M. Alfred Goldsmith, vice-president de la Chambre Syndicale de l'Automobile; M. S. de Jonghe, vice-president de la Chambre Syndicale de l'Automobile; M. Willy van den Plas, secretaire de la Chamber Syndicale de la Carrosserie et de l'Automobile; M. Andre, directeur de la Fabrique Nationale d'Armes de Guerre d'Herstal; M. Adolphe Charlet; M. R. Pelgrims; M. J. Van Roosbroeck.

For three days members were most graciously entertained, visiting the most notable factories in the vicinity, and being banqueted in most lavish manner.

At one of the functions the brethren in this country were remembered in a toast to their health and prosperity.

The entertainment was tri-partite in character, as one section after another became hosts of some particular spread.

We brief a few of the addresses. Mr. W. Lawton Goodman, speaking for the British Institute, said: "If we are going to judge by the patronage of the wealthy classes of the International horse shows at Brussels, Spa, Paris, New York and Lon-

don, I would advise you not to forget entirely the manufacture of the carriage for the horse. In London, thanks to their Most Gracious Majesties the King and Queen, the horsed carriage has become once again the fashion of the Court, and the forthcoming coronation will go far towards reviving the popularity of the old-time carriage. The coachbuilders of the world have survived a revolution in the shape of the advent of that wonderful traveller, the automobile, which has annihilated distance and bridged space, and created an international business for the whole world. I congratulate your Chamber on possessing such illustrious members of this craft as the Pipe, the Minerva, the Germain, the Metallurgique, the Fabrique Nationale, and others.

Lt.-Col. Mullins, one well known to members of our own association, who is at the head of the Worshipful Company of Coachmakers and Coach Harness Makers of the City of London, a guild founded by royal charter in the year 1677, for the close association of all those in London then engaged in these industries, and for the benefit and education of the young men to be trained to do good work in the future, was very felicitous in his remarks. He has the added advantage of being able to address the French speaking members in their own tongue.

Quite different from the way affairs are managed by us, the coach builders were joined by the Chambre Syndicale de l'Automobile du Cycle et des Sports, in the person of Le Comte Jacques de Liedekerke, its president.

M. Willy van den Plas hoped that this friendship will prove to be the basis of a closer and more continuous relationship in the future, and will moreover be the foundation of an International Federation of Coachbuilders, which, in binding us still more closely in the bonds of fellowship, will do much in the furtherance of our common interests.

The three-day meeting was most significant of the cordial relations that are cementing the industry in important foreign centers. May the good will be sustained through the years.

LACQUER MANUFACTURE IN JAPAN.

From Consul-General Thomas Sammons, Yokohama, we learn that Ye'no'abura is a vegetable oil derived from the seeds of the *Perilla ocimoides*, an annual plant, and uru'shi is the sap collected from lacquer trees.

Statistics show that the annual production throughout Japan amounts to an average of 335,000 bushels, from which over a gallon of oil per bushel is extracted. The oil is retailed at 35 cents per sho (0.4766 gallon), and is used in the manufacture of paper umbrellas, lanterns, oil papers, and artificial leather. It is also used in preparing materials for the manufacture of printer's ink, paint, varnish, and lacquer.

The lacquer trees are occasionally cut down, but the usual method is to tap them about 9 inches above ground. The gum which accumulates is collected with a spatula made for the purpose. Four days after the first collection of gum the trees are tapped again.

Refined lacquer contains 85 per cent acid of lacquer and 15 per cent water and organic matter resembling rubber. The juice dries by absorbing oxygen, which it can do only when the atmosphere is damp. With the addition of a little glycerin, the drying process requires only two hours, whereas under normal conditions more than ten hours are necessary. Alcohol is used in melting the material.

The gum is sold direct to dealers in lacquer, who refine the raw material themselves. It is first passed through a filter made of cloth into a porcelain or wooden receptacle. The waste remaining in the sieve is rejected, and the gum which may still adhere to its sides is mixed with the yeno abura and strained again into the receptacle. The resulting liquid is exposed to the air and, after being carefully stirred for a day or two, it attains a standard thickness. Heat is used to evaporate the water which may remain. Coloring matter, kneaded with yeno abura, is added to the material while it is raw.

SATISFACTORY ADJUSTMENT OF SOUTHWESTERN FREIGHT RATES.

At a meeting called by Theodore Luth, chairman of the Freight and Classification Committee of the Carriage Builders' National Association for conference with the executive officers of the Southwestern roads and vehicle representatives, relative to an advance in rates and minimums which were to take effect September 25, but upon protest from vehicle interests, postponed by the Interstate Commerce Commission to November 1, an agreement was reached as follows at a conference at Chicago on October 12 between the representatives of the railroads and the committee of vehicle representatives:

With respect to minimum weights and rates on vehicles and parts thereof (exclusive of self-propelling vehicles, children's vehicles and hearses) to Texas, the present basis of double minimums to be cancelled and in lieu thereof the following minimums be established:

| | |
|-------------------------------------------------|-------------|
| 36 ft. 6 in. and under in length | 10,000 lbs. |
| 36 ft. 7 in. to and including 40 ft. 6 in. | 12,000 lbs. |
| 40 ft. 7 in. to and including 46 ft. 6 in. | 18,000 lbs. |
| 46 ft. 7 in. to and including 50 ft. 6 in. | 20,000 lbs. |

on basis of the present Class A rate of 85 cents, St. Louis to Texas Common Points with Class A differential from defined territory and points taking higher than Texas Common Point rate.

It being further understood that this basis will be made effective from basing points and from prerating points in defined territories on a date to be fixed by the Interstate Commerce Commission, and be continued in effect until after a further conference with the vehicle interests. But from non-prerating points in Central Freight Association territory, the basis will not be permanent. It will be put into effect as a temporary measure until March 1, 1911; in the meantime, negotiations to be conducted with Central Freight Association lines looking toward their sharing the burden of this adjustment instead of exacting as at present, their full local rates and higher minimum weights to Southwestern gateways. If by March 1, 1911, such arrangements are not consummated, then this understanding terminates so far as it relates to the non-prerating points in Central Freight Association territory.

This memorandum to be filed with the Interstate Commerce Commission as indicating a disposition of the case now pending before them, and which is to be heard at St. Louis on Saturday, October 15, so far as the parties to this memorandum are concerned.

The above memorandum of understanding was presented to the Interstate Commerce Commission in St. Louis, on Saturday, October 15th, by the railroads and vehicle representatives. Upon hearing it was stated that the examiner would immediately return to Washington and make report to the Interstate Commerce Commission and that honorable body will without doubt issue an order thereto establishing this basis of minimums and rates, to become effective at an early date. It should be a matter of congratulation to manufacturers and the railroads that such a negligible agreement can be reached after a thorough conference instead of having arbitrary rates and minimums issued by subordinate officials without thorough investigation and expert knowledge of the conditions and circumstances surrounding the vehicle traffic.

Representatives of the following roads were present: A. T. & S. F., C. R. I. & P., St. L. & S. F., Mo. Pac., Iron Mountain, and M. K. & T. railway companies, and the vehicle manufacturers were represented by Theo. Luth, Carriage Builders' National Association; C. A. Barnard, Carriage Makers' Club, Cincinnati, O.; W. N. Agnew, Vehicle Shippers' Traffic Bureau, Flint, Mich.; W. J. Evans, National Association of Agricultural Implement and Vehicle Manufacturers, St. Louis, Mo., and C. T. Platte, Indiana Vehicle Manufacturers, Indianapolis, Ind.

Dealers' Association Federation.

Twelve dealers' associations were represented by forty delegates at the annual meeting of the National Federation of Retail Implement and Vehicle Dealers' Associations, held in Chicago, October 11, 12 and 13.

From the standpoint of attendance and interest it was the most successful meeting ever held, and the important matter under discussion was direct selling by manufacturers. The address of Joseph G. Baker, the president of the Federation, was a statement of what the dealer demanded. Secretary Hodge said:

The recognition which has been given this federation by manufacturers, jobbers and the trade press tells of the position it has assumed in the commercial world, a result of conservative, but aggressive, management. That conditions need improving admits of no argument. The membership of our constituent associations has increased the past year without exception. The work in hand has been mainly to secure protection to our members' interests, not only against violations of trade rules, but in legislative matters.

Real progress was made in the parcels post fight. As soon as information was received that the committee on Postoffices and Post Roads would grant a hearing so that both sides might present their arguments, your president was sent to Washington as such representative. The result of the hearing was that the committee held the matter up, making no report whatever. It developed in the course of the proceedings that the real purpose of those who were instrumental in introducing the rural parcels post bill is to secure a general domestic parcels post and that the rural plan is merely a stepping stone, just as we have claimed. Establishing this fact was gaining one of the main points in the issue. The chances are that more active work will have to be done on this matter again the coming year, as the advocates of the parcels post are busy and both political parties are embodying planks in their platforms favoring legislation along this line.

Considerable time has been devoted the past year to investigating the so-called rating bureaus, that secure for mail order houses financial rating on individuals. So far as I am able to learn, implement and hardware dealers are supposed to be in closer touch with the trade than any other class of merchants, hence they are called upon more frequently to act in the capacity of information bureaus to these agencies which assume fine sounding names. I have investigated nineteen of these concerns and reported the names of sixteen to the secretaries of constituent associations in a general letter, and they have doubtless communicated the information to their members. Dealers take a great interest in this matter, and the investigation has resulted in hundreds of blanks being sent to my office by members who appreciate the information.

I have no real progress to report in regard to the vehicle warranty. Just prior to the convention of the Western Association in Kansas City last January, notice was received from the secretary of the Carriage Manufacturers' Association of America that a committee of five had been appointed to confer with the National Federation concerning an equitable vehicle warranty, and a call was immediately issued for a conference to be held January 12. This conference was attended by the manufacturers' full committee of five from this Federation and several members of constituent associations. The president of the manufacturers' association stated that the object in calling the conference was the necessity which manufacturers felt of having a warranty which could be made effective and they presented the following draft which has been prepared by the manufacturers' committee:

Official Vehicle Warranty.

As a private vehicle only. This vehicle is guaranteed with fair and reasonable use as a private vehicle for one year from date of purchase. It is also guaranteed to be as represented and described in catalogue.

If any part of said vehicle be defective in material or workmanship and is returned to the factory by freight, the same will be repaired or replaced free; the manufacturer paying transportation charges one way. No repair bill will be allowed unless previously agreed upon.

The manufacturer will not be required to reset tires or renew tires, nor will he become responsible for damage to wheels that are run with loose tires.

The rubber manufacturers' guarantee will apply to all rubber tires.

The vehicle manufacturer shall not be responsible for any damage to paint and varnish resulting from the action of ammonia or extraordinary exposure to the elements.

This was discussed at length, the dealers taking the position that the twelve months' time limit should date from the day of sale to the user. The manufacturers insisted that the dealer's position was not well taken. Finally a committee of three from each branch of the trade was appointed to outline a warranty that would be equitable to all concerned. The manufacturers were represented by C. C. Hull, W. A. Merrifield and W. A. Sayers; the dealers by T. G. Wiles, Joseph G. Baker and P. T. Rathbun.

This was not to become effective until approved by the Manufacturers' Association and the Federation. [It has not yet been so approved.—Ed. Hub.]

Cost Educational Work.

One of the most important matters to come before this meeting is the Cost Educational movement. The intense interest taken in this subject by dealers at the conventions showed the wisdom of considering it, and from the best information I can gather I must conclude that many dealers have put into practice the rules for figuring costs suggested by the Cost Educational System and recommended to them by their respective associations.

This federation should at this meeting place itself on record in opposition to the proposed general advance in freight rates. This is all the more important on account of the fact that a rumor is current that retailers generally are not interested as they will simply pass the advance on to the consumer. The absurdity of such a rumor is apparent. Nevertheless whatever influence we have should be exerted to show that the retail implement dealers of the United States are opposing the advance. The shipper's committee that has been conducting the hearing before the Interstate Commerce Commission has expressed the opinion that the dealers' association and this federation can effectively supplement the work it is doing, and we should hold ourselves in readiness to take up our share of the burden.

The dissatisfaction felt by the general public in regard to express rates is assuming definite shape in several states, and is another matter which this federation should take cognizance of. In Kansas the railroad commissioners have ordered a reduction of 10 per cent on merchandise rates and from 40 to 60 per cent on farm implement repairs. In Illinois the commissioners ordered a reduction, but it is understood the companies will ignore it and force the matter into the courts. Commercial organizations in Michigan, New York and other states are taking steps to secure relief, and the attitude of the express companies is such that it is likely to become a subject for national legislation. As representatives of the retail implement dealers of the

United States we should do what we can to further our constituents' interests, hence, some action should be taken at this time.

It must be admitted that there are too many retail sales being made by manufacturers and jobbers, those who have a reputation for protecting the trade. Too many of them justify their actions by claiming that they maintain a good differential between wholesale and retail price. In some cases they send these commissions to dealers, but in a large percentage they simply express a willingness to place the commission if they can get some dealer to buy their line of goods and in too many instances the margin above wholesale price is out of line with the suggestions which have been made for the conduct of a retail business by the Cost Educational Association. The methods of the sales departments of some of the concerns from whom our members are buying are subject to criticism.

The wholesaler who sells at retail and refuses to pay a commission unless he can make said commission secure for him a customer is not affording dealers any more protection than one who positively declines to pay commissions upon shipments to points where he has no agent. I have thought that perhaps it would be well to go back to first principles and make this practice of jobbers and manufacturers interfering with the retail business one of the live subjects for the coming conventions, and let it be known that the discussion will be open to all.

FIFTEEN PER CENT CUT IN TIRES.

Rubber tires are to be sharply cut in price on December 1. A horizontal slash of 15 per cent has been decreed and the new order of things will go into effect on that date.

The course of the raw rubber market has followed the inexorable laws of supply and demand and at present is in the neighborhood of \$1.40 a pound. The course of the market has been downward recently, with a few little spurts when isolated manufacturers tried to secure their annual supply. The tire men say that the current level is still too high and no purchases of great importance will be made until they can be executed somewhere about \$1.20 a pound.

Even under the improved conditions that have obtained so far this Fall the cost of tires has proved a big obstacle to motoring and the general reduction will be particularly gratifying.

The understanding of the tire men and the makers is still in force and the manufacture of tires has been conducted conservatively. Outside supplies of raw rubber have been called upon rather more extensively than ever before and in the exact measure that the demand has been released from the central rubber market, prices have sagged off.

Tire men are somewhat apprehensive lest the announcement of the cut will have the effect of stiffening the demand for the finished product and have taken precautions not to stimulate the raw rubber market by heavy purchases.

They say that the market is in a nervous condition and shows signs of a "corner" whenever a big buying order is shown.

A. L. A. M.'S LAST SHOW.

When the doors of Madison Square Garden close upon the automobile show to be conducted by the A. L. A. M. next January, they will have closed upon the last show ever to be held by that organization in New York. In 1912 the display of automobiles in the metropolis will be handled by the licensed dealers' association and the show will be in the same class as that held annually in Boston.

The reasons for this action are the holding of a manufacturers' show is an appreciable element of expense that can be taken care of in another way; that the dealers in motor cars object to a manufacturers' show in their territory. This will leave the Chicago show as the only *simon-pure* makers' exhibition in the United States.

REDUCTIO AD ABSURDAM.

The following is the conclusion of a builder of motor cars of the pleasure type. It seems a failing of the enthusiast that he is inclined to run to extremes, making of a fairly strong position an absurd deduction based rather on imagination than probable fact:

"It is safe to say that for the ten years, 1900 to 1910, the average production of horse-drawn vehicles of the family and pleasure type would amount to 900,000 annually. The average life of vehicles of this type, estimated conservatively long, is ten years. This would mean that there were in actual use, at any stated period within the interval, at least 9,000,000 family and pleasure vehicles. With the exceptions incident to any line of business, every owner of a horse-drawn vehicle of the cheapest and simplest type, will be an ultimate buyer of a motor driven vehicle. Even though the motor vehicle may cost more than the horse-drawn vehicle, the increased efficiency, in the way of health and activity of the owner of the motor-driven vehicle, will more than offset the increase in cost of the motor vehicle. In this connection it will be found that the increase in cost of the motor vehicle disappears, or is not so great as it was thought to be. In the first place, one motor car of the modern type will take the place of three horse-drawn vehicles of the family and pleasure type. When the cost of three horse-driven vehicles, plus the price of the horses, harness and trappings, is placed against the cost of the motor car, it will be found that the motor car is not such an extravagance as it was supposed to be. Granting the same statement that one motor car will displace three horse-drawn vehicles of the family and pleasure type, it will require approximately 300,000 motor cars annually to supply just the normal demand, without taking into consideration the abnormal demand incident to substituting motor vehicles in place of the 9,000,000 horse-drawn family and pleasure vehicles in use. To show how little this abnormal demand has been supplied, it is only necessary to say that on the first of January, 1910, there were approximately 300,000 motor cars, all told, in use.

"The figures and comparisons given above do not refer to, nor touch upon, the vast field of vehicles designed principally for transporting goods, which the government classes under the heading of "Wagons: for Business, Farm, Government and Municipal Purposes." Within this category is to be found the familiar dray and delivery wagon, both of which are almost immediately susceptible to being displaced by motor trucks. Of the various types of wagons, there were produced in 1900 570,428; in 1905 there were produced 643,755, or an average, for the two intervals, of 607,091. A conservative estimate of the life of this class of vehicles is ten years, which would indicate in use at any given time within the period named, a total of over 6,000,000 wagons. The number of motor trucks which has been manufactured to date, towards supplanting this number of wagons, is comparatively infinitesimal. After the abnormal demand for motor trucks is satisfied it will require not less than 100,000 motor trucks annually to supply the normal demand incident to increase in population and wearing out of old vehicles.

"In the face of this, can any sane person longer have any doubt as to the economic soundness of the motor vehicle industry? The fact that some motor car manufacturers may fail, owing to lack of good business management or failure of product to "make good," is not the slightest indication of any unsoundness of the industry in general."

WANTED ABROAD.

An Italian business man advises that he desires to represent in that country American manufacturers of oxide of zinc, white lead, carriage varnishes, and machinery for grinding and mixing paints. He already represents a French house making these lines, but desires to extend his business with American concerns. References will be furnished, and correspondence may be in English, French, or Italian.

McCullough on Cost-Accounting

The following paper on "Cost Accounting" by E. W. McCullough, was read before the Tri-State Dealers' Association in October, at Cincinnati, Ohio:

It will be recalled that the Cost Education Association was created by joint action of organized retail dealers, manufacturers and jobbers, at a meeting held in Kansas City, January 11, 1910. The support of the organized dealers has been pledged to the movement by their federation, which met in Chicago the previous October. At the organization meeting, a constitution and by-laws were adopted, and officers duly elected. The government of the Association being placed in the hands of an executive committee of twelve consisting of three members each of organized dealers, manufacturers, jobbers and trade papers. The headquarters of the association was established at Chicago, and one of the first acts was to formulate and distribute a series of rules for the correct ascertaining of the costs of doing business in a retail implement and vehicle establishment. Over ninety thousand of these rules and suggestions were furnished to retail dealers' associations, manufacturers and jobbers, who distributed them among their members and customers, both through the agency of the mails and traveling representatives.

The first issue of information was a little later followed by another containing a revision of the first rules, which were much more complete, and also containing an infallible table for figuring the selling price of any article after the percentage of cost had been ascertained, and using a selected percentage of profit. This second issue was known as "Suggestions No. 2," and being put up in vest pocket size is to-day in general demand, and large quantities of them are being supplied to all parts of the country.

The distribution of this literature, however, has been curtailed to a certain extent by reason of the association lacking funds to distribute it free. In fact all of the one hundred and twenty thousand copies sent out have been paid for by those ordering them, with the exception of six thousand that were mailed with letters to organized dealers soliciting their membership and cooperation with the work. The interest created by the distribution of this matter and by the personal work done by many of the Retail Dealers' Associations throughout the country, has attracted the attention of the grocery, hardware, paint and oil, and various other lines, so that nearly every trade journal in specific lines of merchandise has given the matter special attention, and all of this influence has been exceedingly helpful to our work.

During the year many dealers' associations who previously had no committee on costs, have appointed them, and at their coming annual conventions this fall and winter, this subject will be given more attention than ever before, which it justly deserves.

Within the past few weeks the executive committee of the Cost Association has met with the Dealers' Federation, made its report, again received the enthusiastic support of that organization, and it has already urged upon its constituent associations the advisability of making this subject the most prominent one on their convention programs; also each association has been requested to appoint a special committee to solicit memberships for the Cost Educational Association at its coming convention.

The manufacturers and jobbers, who will hold their annual convention at St. Louis early in November, have also been requested to appoint a like committee with similar duties, and it is hoped that the membership of the Cost Association will be greatly increased by this effort, for not only is the work worth while, but is of vital importance to all interests concerned.

So much for the doings of the association.

Now what has the Tri-State Association done as an organization along these lines, and what are they going to do this coming year? We are informed that as an organization it has distributed about ten thousand circulars of cost information and undoubtedly where these have been received and read by those always on the lookout for anything that will build up their business and hold their profits, much good has been done by them, but education in any line is a slow road to some, and we must understand that the benefits of cost education must not only be understood and accepted by ourselves, but in a tactful manner urged upon those who are in the same line of business, but because of lacking this knowledge may be termed our "reckless competitors."

We are aware that there is a hesitation on the part of some in mentioning these matters to their competitors, feeling that it may be wrongfully construed by them as an attempt to tell them how to run their business. But the profits to-day in all established lines are getting less so rapidly that nearly every merchant is concerned and interested in any plan that will show him how to get profits, and we find from reports of manufacturers that the suggestions offered along these lines by their traveling salesmen have not only been well received, but more information asked for. Still, these travelers only see your competitor occasionally, while you meet him every day. Therefore, both agencies should be used to get him to figure his costs and selling prices on the right basis.

Recently an educator in the high schools of one of our large western cities picked up our little pamphlet "Cost Suggestions No. 2," and becoming interested in its contents, wrote for more information, making the statement that although the high schools of this country were teaching a business course, their efforts were confined entirely to the matter of record keeping, and that nothing whatever was given the student concerning the ordinary items of expense, their relation to the selling price, nor their influence on the matter of profit. Consequently, in his opinion one of the greatest essentials to business was being overlooked, and to-day we are in correspondence with him concerning this very subject—Cost of doing business and how it can be applied to the course of study being taught in our schools.

We feel that it is no longer necessary to argue with any up-to-date dealers' organization as to the absolute necessity of knowing the relation of expense and profit to selling prices, but the question which confronts us is: How much your members have applied the information which has been given them during the past year, and what can be done to arouse the indifferent and get it more generally applied during the coming year? There is, perhaps, no subject in all the important items taken up by trade organizations which can yield larger money results than the working out of this one in a practical way, for it is patent that unless every penny of expense is added to the delivered cost of goods, and then some profit to that, every sale you make is eating into your capital and bringing you nearer to failure. The actions of your competitors, no matter how much goods they may sell at prices that do not net a profit, can not injure you in any way if you know your costs and provide a fair profit on every sale you make, for it gives any man backbone if he knows exactly where he stands, while uncertainty on the other hand is always weakness.

We trust, therefore, that this association will not only thoroughly discuss this question, and that every member who has started right, will give his experience for the benefit of others, but that a cost committee comprised of men who know from experience that cost information pays, will be appointed to look

after this matter the coming year, with power to take any action that may seem to them reasonable to urge upon other members the necessity of making a start, if they have not already done so.

We have had sufficient agitation and talk, now let us go after results in the most practical manner.

FACTS ABOUT THE FOREST FIRES.

A rough estimate of the fire loss upon the national forests in Montana and northern Idaho, upon which the Forest officers of the United States Department of Agriculture have been engaged since the fires were put out, puts the total amount of timber killed or destroyed in this one district at over 6 billion board feet, while the area burned over is put at over 1¼ million acres.

The heaviest losses were in two Idaho forests, the Couer d'Alene, where over three billion board feet of timber are reported killed or destroyed and over 450 thousand acres burned over, and the Clearwater, where one billion feet of timber were killed or destroyed and 300,000 acres burned over. On the Helena National Forest, in Montana, the loss in timber is believed to have been 500,000,000 feet, on the Cabinet Forest, 400,000,000, and on the Lolo Forest 300,000,000.

A large part of the losses on the Couer d'Alene, Clearwater and Lolo were due to what became practically one great fire. The burn is shown on the Forest Service maps as extending in a northwesterly and southeasterly direction from north of Wallace, Idaho, to a point some 30 miles southwest of Missoula, Mont., or about 100 miles. At its widest point this burn has a width of about 40 miles, but its shape is very irregular.

It was really a union of a number of separate fires, driven to fury by the fierce hurricane of August 26. To the west of the Idaho-Montana boundary in the region of this fire lies a very inaccessible mountainous country, into which, on account of the absence of trails and of forage, it was almost impossible for forces of fire fighters to penetrate. When the hurricane arose it drove the fires upon the parties which were hewing a way towards them, forced these parties to seek refuge wherever it could be found, and swept down upon the forests where the fires were up to that time generally well in hand. The extensive losses are ascribed to the combination of hurricane and lack of means to get to the fires and put them out before the storm came. On the forests which were best equipped for controlling fires the results achieved are regarded as a demonstration of the efficacy of the fire-fighting methods employed, even under highly adverse natural conditions.

Forester Graves believes that, as usually happens in the case of big fires, there will be found to be considerable areas of living timber within the regions now mapped as entirely burned over. Of necessity, the figures given are tentative, for it has been impossible to examine all the burned areas thoroughly. As fast as possible, however, the forest officers are locating and estimating the bodies of timber killed, but capable of being lumbered, if taken in time. There will be an enormous quantity of fire-killed timber, both on the National Forests and on private lands, to be disposed of as soon as possible, since if not marketed quickly it will not be worth cutting at all.

The Department of Agriculture will push vigorously to dispose of this fire-killed timber. As with all National Forest timber, it will be sold on the stump, to millmen who will lumber the land, paying a set price per thousand board feet for the timber, and conforming to whatever regulations are stipulated in the interest of the forest. Pending the disposal of this fire-killed timber, future sales of green timber from the National Forests which were badly burned last summer will probably be greatly restricted, if not entirely suspended.

Since the amount to be disposed of is doubtless greater than can be marketed in any event, and since it is better for the country that the timber should be utilized than that it should go to waste in the woods, the price at which it will be sold will be lower than would be asked for the timber under ordinary cir-

cumstances. Generally speaking, Secretary Wilson does not regard it as a wise public policy to sell off the National Forest timber except when it is in reasonably good demand, for the country is sure to need the supply badly later on. But with the fire-killed timber it is a case of now or never. Consequently there is an unusual opening for lumbermen who are ready to buy National Forest stumpage at bargain prices.

How much of the six billion feet which was either killed or burned up in Montana and northern Idaho can eventually be salvaged it is of course impossible to predict. If it were all a total loss, and if its stumpage value were put at the average price at which National Forest timber was sold last year, it would be the equivalent of a money loss of about fifteen million dollars.

It is believed that last summer's fires either burned up or killed between one and two per cent of the total stand of National Forest timber. At the present rate of cutting from the National Forests, six billion feet is equal to twelve years' supply; but it is less than one-sixth of a single year's cut in the entire country, or enough to keep all our lumber mills busy for something under two months.

INDUSTRIES TAPPED FOR AUTOMOBILES.

A new and undreamed of market was created for pig aluminum and aluminum products. The motor car called for vast quantities of high-grade and other steels. Mountains of curled hair were required to upholster the machines and oceans of paint and varnish were used to finish them. Upholstery leather was removed from a drug on the market to an article in keen demand.

The vehicle spring makers were taxed to their utmost capacity to supply the needs of the motor car builders. Sheet brass and copper were required in enormous quantities to construct lamps and the trimmings of motor cars. Hardware specialties and numerous other articles were in strong demand. The production of all of these materials required in the motor car industry employed a great force of workmen entirely outside of those directly engaged in the manufacture of complete motor cars. Further, and by no means least, the manufacture of motor cars brought about an unheard of demand for machine tools of the best character. The production of these machine tools consumed pig iron in large quantities, machinery and tool steel and bearing materials of various kinds. The machine tool manufacturers gave employment to great numbers of men, as a direct result of the demand of motor car manufacturers for high grade tools and implements. One of the most important materials used in the motor car industry has not been mentioned—namely, rubber. The requirements of the motor car industry for this material has afforded profitable employment to large sums of capital and an army of well-paid workmen.

TINKERING THE MOTOR.

Drivers of motor vehicles are in the main conscientiously careful of their machines. Yet there are some men who take them to pieces so often for cleaning or minor repairs, that many of the parts are distressed, and show this in future rapid wear, when the machines are once more running. Every driver of a motor vehicle knows that when the ball-bearing hub of the wheel of a car is taken apart and is put together again, it subsequently wears more rapidly because the races are not put back exactly in the same position as at first, or because, conceivably, the balls are not put back in the same sequence. Again, there are, in many sets of machinery yet turned out, little defects and evidences of bad workmanship, of which none but the original erector is aware. These will, as a rule, never cause any failure so long as the machinery is in the same undisturbed state as when it left the works, but, when once the mechanism is dismantled, actual faults are quite likely to develop, and these may be detrimental to the working of the machinery when it is once more set in motion.

WONDERFUL MAN, THE MOTOR DESIGNER.

The English Motor has the following effusion from an engineer who shows what improvements we will see now that the engineer has time to turn from tinkering with his motor, to a consideration of how the motor body ought to be built, but has not been built up to the present, simply because the engineer has not had the leisure to take the subject in hand. Listen to the mocking bird as we reprint some of his carol:

"It is curious to recall to mind an absurd notion which prevailed in the early days of the railway improvement. The point alluded to concerns the style of the carriage drawn by the locomotive. The idea then obtained that the railway cars should be made to resemble ordinary horse-drawn vehicles, and, so strong was this belief, that, even to-day, a train of railway carriages is spoken of as being made up of so many coaches.

"It would seem reasonable to suppose that this stagnant state of affairs arose principally from the fact that engineers were occupied so busily with improving their engines that they had little time to attend to the comfort and convenience of the passengers, and consequently, the builders of the rapidly-disappearing stage coaches tried their 'prentice hands at the work of making appropriate carriage bodies. And anyone who has actively been engaged in the motor car industry during the past ten years, can scarcely have failed to observe a distinctly similar fashion of the coachbuilder's art that was, until quite lately, prevalent. Those who can recollect such bodies as the Benz and Mors dogcarts, the Turcat-Mery, or even the original English Daimler will admit that their likeness to the horse-drawn carriages was only too obvious. Trailing wheels of excessive diameter, steering wheels of small size, low-backed seating accommodation, a diminutive board for the "dash"—these were the main characteristics which, to me, invariably imparted the impression that the horse had run away.

"When the motor car constructor had leisure to turn from the chassis to the body, it became evident that the out-of-date coachbuilder was no longer to pursue his placid way. Hence, the first sign of real activity and change may be said to have begun when side entry doors to the rear seats were devised, and subsequently, we came to what has been dubbed the torpedo or the gunboat style of body. Personally, I think a much more apposite title is that of the "box" body, for, indeed, it would seem that the motor vehicle manufacturer had instructed the coachbuilder pretty plainly to make him a capacious case wherein the passengers might be ensconced comfortably.

"Looking at the bonnets and dashboards, the high, box-like locomotive style of dashboard is absolutely incomparable. I cannot believe that anyone, after trying this sort of dashboard, would prefer a different kind. This is best explained by the fact that the steering wheel is shielded entirely from the wind rush, and it follows that the greater part of the driver's person is protected likewise. The driver is enabled to manipulate the wheel in complete comfort while his eyes, instead of wandering aimlessly on to the radiator cap, are directed straight ahead on to the road. There is, I am of opinion, little to be said for the ridiculous form of scuttle dash that carries a continuous blast of cold air against the steering wheel; and its appearance, especially where used conjointly with a low bonnet, is unattractive, not to say decided ugly. In this matter of carriage design, I am persuaded that graceful contour and grateful comfort rank *pari passu*; that solely by the aid of the one you shall enjoy the other.

"Having considered the dashboard problem and how it has been solved effectively, one may turn one's attention to the subject of lateral doors. These should be high and of the same measurements in front as at the rear without unnecessary curves. If curves are introduced, you merely break up the continuity of the straight line appearance, of equal spacing, and at the same time encourage the entrance of the chilly wind. If the front doors and seat are lower than those in the rear, then the incongruity of the effect is augmented. The most convenient

method of opening and closing the doors may seem an item of small moment, yet it is well worthy of thought. The average car is provided with hinged doors, just as was the old-type railway carriage. I think the modern motor vehicle should assuredly be furnished with doors adapted to slide into hollow panels at the side of the seats. I daresay the prophecy that such doors would rattle may be uttered against them, but since experience has shown that they do not do so, the doubt may be dismissed from one's mind. Another strikingly simple departure about this particular novelty is that the doors are self-opening, inasmuch as they are attached, at the back, to a coil spring. On releasing a catch, by which they are held shut, they slip back automatically into the panels; the spring is in tension while they are closed and, further, it may be adjusted to give them any rate of velocity desired. Hitherto, I must confess to a prejudice against high front doors, because I considered that the driver's movements should always be unencumbered in case of emergency. The device described has banished that feeling. That the sliding door for motor cars answers admirably is indisputable.

The remaining point about carriage work is that the seats should be adjustable both as to height and angle of tilt. I have been in several closed cars having this delightful arrangement and I can imagine nothing better except, perhaps, that it would be improved further still by the adoption of movable backs for the seats, after the manner of the Ottoman couch. In that case one could transform a well-padded seat into a veritable lounge chair.

"Notwithstanding that the constructional points of interest, to which I have drawn attention, are at present found as features pertaining to the more or less expensive vehicle, they are capable of being embodied in the relatively cheap car. It is true that the advantages of the locomotive cab dashboard, sliding doors, and adjustable seats are not just now within everyone's reach, but without doubt, public demand will reduce the cost appreciably. An attribute of the box body is that its style lends itself to lessened cost of construction. With it there is no elaborate moulding, paneling, or the like, no grotesque curves. Once its skeleton frame is fitted together, it may be covered by pressed steel sheet without difficulty. By that means you have a light, yet substantial body. And when the fabric is finished, we would do well to rid ourselves of another old-time custom, namely, laborious and expensive painting and varnishing."

And still they gazed, and still the wonder grew;
That one small head could carry all he knew!

ONE WAY TO TAX MOTOR CARS.

Consul C. N. Daniels, at Sheffield, Eng., says in a report: Many of the physicians of this city have given up the use of horses and carriages and have adopted the automobile, and having adjusted their practice to the speed of the car they will be loath to give up their use.

The new motor car taxes which went into force September 1, whereby licenses are issued upon the basis of horsepower units, promises to make the keeping of high power cars so expensive a luxury that only the very rich or the very extravagant can afford to use them. The new tax rate is from £1 (\$4.86) for a motorcycle to £42 (\$204.39) for cars above 60 horsepower. It is stated that many of these cars are being freely offered at very low prices and there is practically no demand for cars above 20 horsepower, the most popular at the present time being for those under 15 horsepower, the duty on which is not above £4 (\$19.47).

Unless this demand has been foreseen by the British manufacturers it must take them some time to adjust their works to the changed order of things, and this situation seems to offer an opportunity to the American manufacturer of a reliable and reasonable-priced car of lower power. The increased tax is bound to help break down the prejudice against the car of this type, and the American with such a car and the ability and willingness to demonstrate its economy of operation and its capabilities ought to find this market in a particularly receptive mood.

COMPOUND WAGON AXLES.

What wood is just as good or better than ash for wagon poles?

What wood is just as good or better than hickory for wagon axles?

What wood is just as good or better than poplar for wagon boxes?

What wood is just as good or better than oak for wagon hubs?

Substitutes have been used, more or less, for all of these woods, but the substitution has not been because of the superiority of other woods, but because of the growing scarcity and corresponding advance in cost, rendering these goods, in some instances, at least, almost prohibitive for use by wagon manufacturers.

The possibilities advanced in relation to compound hubs should go a long way toward solving some problems for the wagon manufacturers. It is the intention to compound one inch material, for instance, into any desired dimensions. The grading rules of all woods entering into the construction of wagons are very rigid and especially so regarding the grading of axles.

A standard axle for a $3\frac{1}{4}$ wagon is 4 in. by 5 in. by 6 ft., containing just ten feet board measure in which the grain must run straight. Any saw mill man who has made a business of sawing axles knows the difficulties encountered. It is quite easy for an amateur in the business to size up on the skids a hickory log which measures possibly twenty inches in diameter and twelve feet in length and to figure the number of axles he will get out of it, but the experienced man knows that the only way to determine how many axles a certain log will cut is to count them when shipping dry.

The mill man who sells No. 1 hickory axles f.o.b. Chicago, for \$65.00 to \$70.00 per M. is not getting rich so fast as the one who has not tried it would suppose, especially when the high cost of hickory stumpage is considered. The manufacturer buys these axles shipping dry and stores them under sheds for an average of three years before they are ready for use. In the meantime, defects have developed in quite a percentage of them sufficient to render them useless for axles and they are sawed into smaller pieces for a different use entirely where a much less expensive quality of hickory would do as well. Axles are but five feet long when finished for the skeins, but are bought six feet long to provide for checks on either end. If both ends of a hickory axle wood checks in seasoning, as is generally the case, the ends sowed off are too short for use and go to the wood pile, but if one end only is checked, it is possible to get from the opposite end a piece long enough for a brake block. While \$65.00 per M. hickory is rather expensive for brake blocks, putting it to such a use is better than being compelled to burn it or sell for fuel at \$6.00 to \$7.00 per M.

It is proposed to buy less expensive grades of one-inch hickory of narrow widths, which cost but little more than one-half as much as the large dimensions, cement the sound parts or pieces together, forming any thickness or size, with a weather-proof vegetable adhesive compound. In this process, the matter of cross grain is not a detriment and every sound piece one inch thick, five inches wide and five feet long will make a part of an axle, regardless of whether the grain runs straight or not. With very little care, these pieces are arranged so that, although any number of them may be cross grained, they will, when so formed and cemented in one piece, develop a greater strength than the one solid piece now used.

These pieces are built up edgewise, five inches wide for a standard $3\frac{1}{4}$ axle. All axles of whatever size or quality are liable to break when overloaded, and when a one-piece axle does break, it breaks across its whole width and the load goes down, but when a four or five-piece compound axle breaks, the conditions are very different. One of the pieces will break at one place and another piece at another, with a variation of several inches and the grain is so interwoven that it tenaciously hangs

together to such an extent that the axle does not come apart, and, when relieved of its load, will generally spring back into shape sufficiently to enable the wagon to run to the repair shop. Many of these axles have been broken in hydraulic presses with a gauge registering their strength and compared with the one-piece axle they show a very pronounced added strength.

Every one of the pieces in a compound axle enters the shoulder of the skein and, with but few exceptions, wagon manufacturers clip their axles, so there would be no possible tendency of the pieces to separate even though they were not cemented together.

The cement used has passed the experimental stage and has been used for several years on woods subjected to weather conditions. It is applied by special machinery and by powerful hydraulic presses which practically weld the pieces together.

One-inch hickory (or any wood for that matter) is proportionately stronger and more completely dried than large four or five inch dimension stuff. Dry rot, so frequent in the large sizes, would be completely avoided in the compound axle.

While the additional strength of the compound axle is an important feature, a still more important one to the wagonmaker is the fact that the axle is ready for use when taken from the car. Every axle is right; there are no defects, yardage, taxes, insurance, rick or dry kiln expense and last but not least, no long time investment drawing interest. We understand the price of the compound axles will range close to the price of the green one-piece stock and this will mean a substantial saving to the manufacturers of wagons.

DEALERS' CONVENTIONS.

Michigan Retail Implement and Vehicle Dealers' Association Jackson, Mich., November 9, 10 and 11.

Mid-West Implement and Vehicle Dealers' Association, Omaha, Neb., November 15, 16 and 17.

Virginia and North Carolina Retail Implement, Machinery and Vehicle Dealers' Association, Norfolk, Va., November 16 and 17.

Iowa Implement Dealers' Association, Des Moines, Ia., November 29, 30, December 1 and 2.

Illinois Retail Implement and Vehicle Dealers' Association, Peoria, Ill., December 6, 7 and 8.

Retail Implement Dealers' Association of South Dakota, Southwestern Minnesota and Northwestern Iowa, Sioux Falls S. D., December 6, 7 and 8.

Southwestern Kansas and Oklahoma Implement and Hardware Dealers' Association, Wichita, Kan., December 6, 7 and 8.

Oklahoma Retail Hardware and Implement Dealers' Association, Muskogee, Okla., December 6, 7 and 8.

Wisconsin Retail Implement and Vehicle Dealers' Association, Milwaukee, December 13, 14 and 15.

Minnesota Retail Implement Dealers' Association, Minneapolis, Minn., January 10, 11 and 12, 1911.

Idaho Retail Hardware and Implement Dealers' Association Boise, Idaho, January 13 and 14, 1911.

Western Retail Implement and Vehicle Dealers' Association, Kansas City, Mo., January 17, 18 and 19, 1911.

Pacific Northwest Hardware and Implement Association, Spokane, Wash., January 18, 19, and 20, 1911.

Colorado Retail Implement Dealers' Association, Denver, Colo., last week in January, 1911. (Subject to change.)

Southern Illinois and Missouri Retail Implement and Vehicle Dealers' Association, St. Louis, Mo., January 24, 25 and 26, 1911.

Oregon Retail Hardware and Implement Dealers' Association, Portland, Ore., January 24, 25, 26 and 27, 1911.

North Dakota and Northwestern Minnesota Implement Dealers' Association, Devils Lake, N. D., first week in February 1911. (Subject to change.)

New York Retail Implement and Vehicle Dealers' Association, Rochester, N. Y., February 2 and 3, 1911.

Retail Dealers' Hardware and Implement Association of Texas, Houston, Tex., February 14, 15 and 16, 1911.

FORTY-FIVE HUNDRED EMPLOYEES.

The new Ford concern at Highland Park, Mich., will employ the above number now, and more later if necessary. It is an immense plant.

Description of Fashion Plates

"WHITE LINE VEHICLES."

(Illustrated on Pages 223-224.)

The three vehicles shown in the fashion department this issue made by the George White Buggy Co., are good examples of the light work turned out by this representative company. The work is good, strong, serviceable, and the style is pleasing. The method of construction of the cut-under body is interesting. The arch sill construction gives great strength. They say of it "we make the sill heavier and stronger at this point than we or anybody else use in a straight sill body." The work is thorough. The panels are glued, clamped and screwed. The work is done by experienced men and is first class in all respects. There is no better material used anywhere and the workmanship cannot be improved. The bottom boards forward of the seat are $\frac{5}{8}$ -inch thick and are made this heavy because this is where the strength is required. Under the seat and in the back part of the body the bottom boards are half inch thick. The seat is secured to the body by four seat rods which pass through the seat irons and through the sills of the body. Every care is taken to make the White Line body and seat strong and durable without excessive weight.

THE PARRY ROADSTER.

(Illustrated on Page 225.)

The Parry Co. has been quite successful in introducing its new cars. Some seven hundred, the total output, met ready buyers. There is no doubt that the future will be well accounted for. The roadster illustrated gives an idea of the style.

DELIVERY WAGON.

(Illustrated on Page 224.)

The example of a city delivery wagon from the Studebaker shops shown this month is fully up to modern requirements in style, finish and build. The lamps are electric lighted (from storage battery) and all details have been carefully worked out.

TWOMBLY CONVERTIBLE AUTOMOBILE BODY AND REMOVABLE POWER PLANT.

(Illustrated on Page 225.)

While automobile manufacturers are stating that the motor car has arrived at practically a state of perfection, and that only minor refinements and improvements are possible, inventors and mechanics on both sides of the Atlantic are busy trying to design a perfect engine that will overcome a number of defects that exist in the gasoline motor as at present designed.

Out of thousands of alleged improvements which are patented each year, less than five per cent have any practical value.

Mr. W. Irving Twombly, whose inventive talent we have already exploited, after six years' study and experiment, has constructed a small, light and simply designed car which he thinks will revolutionize the business, and solve many problems that have perplexed those who have been operating motor vehicles for business and pleasure. It is almost certain that his engine, on account of its small size, light weight and great power, will commend itself also to our aeronautical friends.

He also believes that his inventions will place the pleasure car within the reach of men of moderate means in the saving of time and money, to say nothing of trouble to those of greater wealth, and will make the commercial vehicle the general, instead of the rare, means of delivery.

Neither the car nor the motor are mechanical freaks designed to gain a little temporary notoriety, but are simple, sane and sound mechanical ideas worked out on slightly different lines than those employed in present practice. That they are abso-

lutely practical Mr. Twombly is convinced. A big factory in Long Island City has been leased, and cars for the market will be turned out as soon as machinery is installed.

Two important features of the new car, irrespective of any question of the merits of the motor, are first, a removable power plant so arranged that it is possible to remove the motor, clutch and transmission, and substitute new ones in from three to five minutes, while the other is, an automobile body so ar-

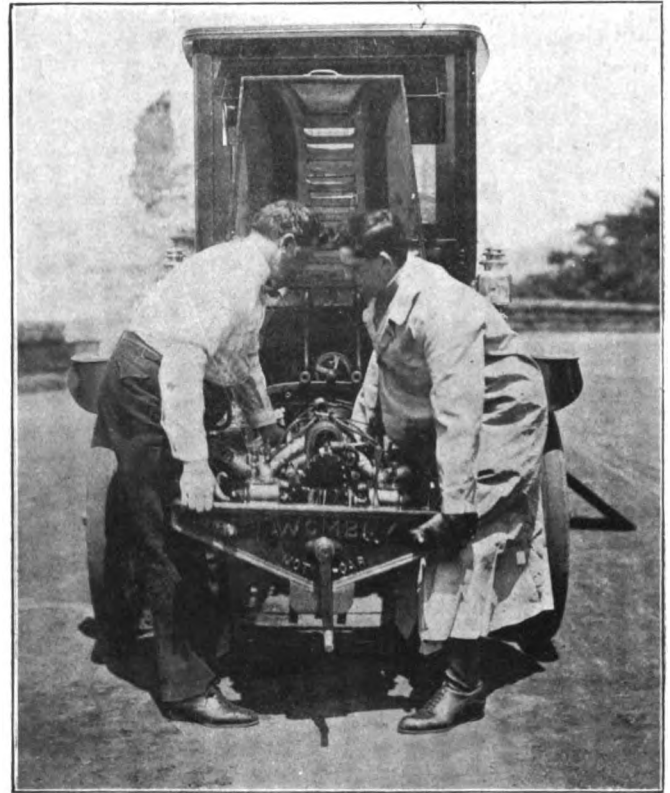

Removing Engine From Chassis.

ranged to be changed from a completely enclosed, heated and ventilated limousine to an open car in less time than it takes to lower or raise the hood of a landaulette.

Briefly, the Twombly motor differs radically from the standard type in that it uses four cylinders, run with a short two throw crank shaft, instead of one of the usual long four-throw variety. Not only this, but with the aid of a simple and practical device which does away with all connecting rods and permits the placing of two cylinders directly opposed on the same center, he is enabled to use one piston for both. This is, in fact, a double-acting motor having neither stuffing boxes, piston rods, cross heads or packing of any kind, and really consists of only two cylinders and two pistons, but having the same torque and balance as a four cylinder motor.

This type of motor also makes it possible to place the cylinders below the water cooler so that the necessity for a circulating pump is dispensed with, as the water is piped from the bottom of the cooler to the bottom of the motor, and from the top of the motor to the top of the cooler, allowing the water to flow freely from one to the other, the principle being the same as in a hot water heating system. Another feature of the motor is that no plain bearings are used, all bearings being made of steel, hardened, ground and polished and having a true rolling contact with steel races, which reduces wear and friction to a minimum.

With Mr. Twombly's construction, the size and weight of the motor is reduced 75 per cent over the ordinary type, and at least 20 per cent is added to its strength and efficiency. In the car illustrated, the 40 H.P. motor only weighed 206 pounds exclusive of a 60-pound flywheel, as against 500 pounds or more, the weight of an ordinary motor of this power. It measures 17

by 17 inches in width and length, is only 8 inches high, and has cylinders of 5 inches diameter, by a 5-inch stroke.

Another feature of this motor is that every moving part is constantly flooded with oil, the surplus or overflow returning to the tank where it is used over and over again until exhausted. Each time it passes through the engine, the oil is washed and strained, removing every particle of dirt and grit, so that it delivers clear, pure oil to the motor. The device is simple and requires no attention except to occasionally fill the oil tank. There is no waste and the motor is always properly lubricated as long as a drop of oil remains in the tank, with no oil showing in the exhaust.

The advantages of the quick-removable power plant are obvious. Under the present system of construction, it takes an experienced man and helper from two to twenty-four hours to

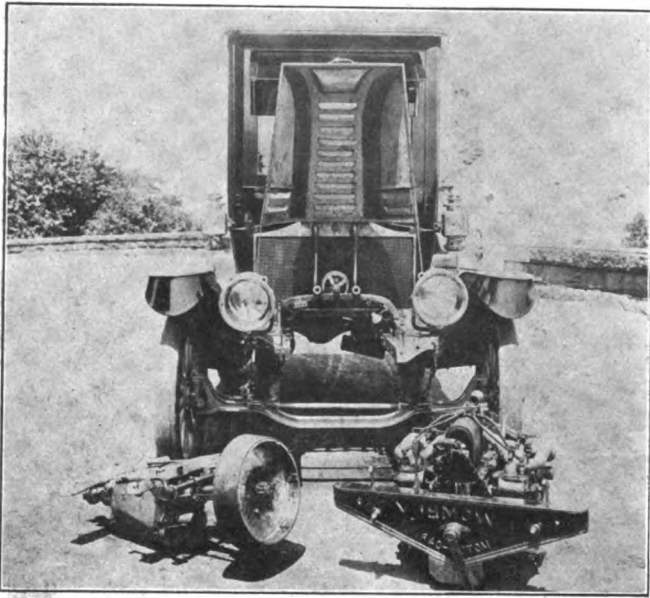

Entire Power Plant Removed From Chassis.

remove the power plant from a machine, and as much longer to replace it; although it may take only an hour or so to make the repairs once the plant is removed. With the Twombly system the entire power plant or damaged part can be removed and replaced with another ready to run in less than five minutes. The damaged part can then go to the repair shop without laying up the balance of the machine, as a spare motor or transmission could be instantly slipped into place. This is of tremendous importance to business men using delivery express wagons, taxicabs and trucks that needs no elaboration.

This body is made entirely of aluminum and glass, and is so constructed that it can be converted in two or three minutes from an entirely closed, heated and ventilated limousine to an entirely open torpedo type touring body. The body consists of pressed steel sills, cast aluminum frame, detachable aluminum panels, cast aluminum doors, glass windows with wooden frame drop inside the body.

The driver's compartment may be left entirely open, with passenger compartment entirely closed, or one or more windows may be dropped in passenger compartment leaving a canopy roof; or rear quarter may be entirely open, or the entire passenger compartment may be left open. In fact, there are numberless combinations not possible in any other type of body. This body is simple, strong, and durable, costs no more to build, and is much less liable to get out of order than the present type of convertible body, and has many advantages the present type does not possess.

If you have not power within yourself from conscious influx from the Divine Source of all power, where do you expect to find it?

TRI-STATE MEETING AT CINCINNATI.

Never in the history of the twelve conventions of the Tri-State Vehicle and Implement Dealers' Association has a greater or more interested gathering assembled than at the one held in Cincinnati at the armory hall, which opened Monday morning October 24,

The first executive session of the association was held at 10 o'clock Tuesday morning when the reports of President T. J. Turley and Secretary P. T. Rathbun were heard. Reports from several committees were read.

The exhibition this year was a decided success. The officers and members were delighted with the showing made. It is doubtful if a more interesting exhibit of the kind was ever shown in Cincinnati. There were nearly 100 manufacturers exhibiting their wares, which consisted of vehicles of every imaginable kind, implements, farming machinery, whips for wagon and buggy teams, automobiles, wagons, gas engines, harness, storm fronts and horse goods, blankets, sprayers, engraving illustrations, storm buggies, separators, and every conceivable accessory.

Both the main exhibition room of the armory and the artillery drill hall, as well as the approaching hall to the latter, were filled with exhibits. The artillery hall was used for the heavier vehicles, including farm wagons and farm machinery.

Fully three hundred attended the smoker given at the Business Men's Club on Wednesday evening. Good music and humorous speeches were the feature of the evening. Howard Saxby delivered a speech on the "Evils of After Dinner Speaking," which was enthusiastically applauded. W. S. Thomas, of Springfield, O., spoke on the "Relations of the Manufacturer to the Dealer," and a speech written by P. P. Huner, attending the Texas State Fair in Dallas, Texas, was read.

"Crops have been bountiful and prices good this year," said Mr. Hunter, "and more buggies and wagons have been painted and repaired during the past two years than ever before. Conditions are ripe to feel the flow of loosened money the coming season, unless the automobile plants begin to 'bust' and scare the bankers back into their tight holes. The farmer will buy the old-time buggy and wagon, for he is convinced that the 'honk-honk' wagon is not useful on the farm."

He cited federal statistics showing that in 1900 there were 14,000,000 horses in this country, with an average value of \$44.61, against 30,000,000 in 1909, with an average value of \$95.64. "Does this look like our old line is going back?" he asked. "Some few carriage shops have been turned into automobile factories, but more carriage factories have doubled their capacity than went through the other evolution."

George P. Wagner, of Jasper, Ind., was elected president. A vice-president and director for each state was elected as follows:

Indiana—First vice-president, T. H. McGeorge, Covington, director, W. J. Bulleit, Corydon.

Kentucky—Second vice-president, A. Brasler, Owensboro; director, F. O. Neutzel, Louisville.

Ohio—Third vice-president, Jos. H. Goldcamp, Lancaster; director, D. H. Steiner, Sterling.

Mr. E. W. McCullough, of Chicago, could not be present, but the paper which he prepared was read and is printed elsewhere in The Hub.

SALE OF ANDERSON CARRIAGE MANUFACTURING COMPANY.

E. L. Anderson, formerly of the Ross Carriage Co., of Union City, Ind., purchased the entire property of the Anderson (Ind.) Carriage Manufacturing Co. from the receiver for \$17,500. The property was appraised at \$40,000. Moss, Yarnell & Co., of Ft. Wayne; the Cincinnati Panel Company, Cincinnati, and Sherer & Co., of Detroit, as three creditors to act with the receiver, recommended that the bid of Anderson be accepted, and the court ordered the sale and acceptance of the bill without notice. Anderson will soon reopen and operate the factory.

YEARLY MEETING OF LICENSED MANUFACTURERS' ASSOCIATION.

For the seventh time, Charles Clifton was unanimously elected president of the Association of Licensed Automobile Manufacturers, at the largest yearly gathering ever held by that organization. Representatives were present from almost every factory in the A. L. A. M. when the meeting was called to order at the association headquarters in New York November 3.

In recognition of their services during the past year, the Board of Managers of the Association returned to office by unanimous vote every official who served during the past year, and passed a vote of appreciation and endorsement of their guidance and work. These included the following:

President—Charles Clifton, Pierce-Arrow Motor Car Co.

Vice-President—S. T. Davis, Jr., Locomobile Co. of America.

Secretary—L. H. Kittredge, Peerless Motor Car Co.

Treasurer—George Pope, Pope Mfg. Co.

General Manager—Alfred Reeves.

Executive Committee—Charles Clifton, Pierce-Arrow Motor Car Co.; S. T. Davis, Jr., Locomobile Co. of America; Thomas Henderson, Winton Carriage Co.; Hugh Chalmers, Chalmers Motor Co.; Herbert Lloyd, Columbia Motor Car Co.

At the meeting of the Association Patents Company, held later in the day, which is a subsidiary corporation of the A. L. A. M., and which owns or controls patents in connection with the construction of automobiles other than the fundamental Selden patent, the following officers and directors were unanimously elected:

President—Charles Clifton, Pierce-Arrow Motor Car Co.

Vice-President—Thos. Henderson, Winton Motor Carriage Co.
Secretary and Treasurer—Alfred Reeves.

Directors—George Pope, Pope Mfg. Co.; I. H. Page, Stevens-Duryea Co.; L. H. Kittredge, Peerless Motor Car Co.; Hugh Chalmers, Chalmers Motor Co.; R. E. Olds, Reo Motor Car Co. and Herman F. Cuntz on patent matters.

There was a discussion of trade conditions, which from reports appear to be even more healthy than at this time last year, and it was noted that the increase in the automobile business during the past twelve months was almost 100 per cent., a record that has no comparison in any other line of trade. It was agreed that a conservative policy with increased care in the manufacture and marketing of cars was the best procedure for the 1911 trade. There are now some 6,500 dealers handling the products of the licenses under Selden Patent No. 549,160.

Chairman Pope, of the show committee, reported on progress being made in connection with the two weeks' show, which opens in Madison Square Garden on January 7, and stated that provision had been made to care for every one of the licensees as well as the accessory people. The first week will be devoted to pleasure cars and the second week to freight carrying vehicles, electrics, motorcycles, etc.

A resolution was passed with a view of having the Licensed Dealers' Association of New York co-operate and affiliate with the manufacturers in the national automobile show, although the promotion and management of the Garden shows remains as in the past, with the A. L. A. M.

RAIN SPOTS FROM WIND SHIELDS.

Take about half a pint of gasoline and dissolve it in all the paraffine wax which it will take up—i.e., make a saturated solution of paraffin in gasoline. The paraffin is not very soluble and but little need be used. Cut it into very fine shavings with a knife and let it stand in the gasoline for several hours, stirring occasionally to facilitate solution. After the solution is made, it may be bottled and rubbed lightly upon the glass as often as is found necessary. A shield covered with this solution will, on the evaporation of the gasoline, be coated with a very thin layer of paraffin, which will in no way interfere with its transparency but will keep from clouding in either damp or cold weather.

REEVES ADDRESSES Y. M. C. A. STUDENTS.

Alfred Reeves, general manager of the A. L. A. M., was the chief speaker at the exercises held in connection with the opening of the seventh year of the automobile school at the Y. M. C. A. Mr. Reeves' address in part was as follows:

"Ten years ago there were about 3,500 machines in America—now there are 400,000.

"Ten years ago there were 27 factories (200 cars being a record production for any one of them)—now we have almost 100 producing factories, to say nothing of a like number of experimenters, involved in the making of motor cars, while an annual production of 15,000 and even 25,000 cars in one factory is not unusual.

"In a decade the capital of the automobile and accessory makers has increased from approximately \$6,200,000 to \$450,000,000 of which \$275,000,000 is in motor car factories alone.

"Ten years ago the number of persons employed in making automobiles and accessories was estimated at 2,000; now there are 278,000 individuals, including those in salesrooms and garages.

"Ten years ago there were probably 800 chauffeurs in New York State, which now boasts of almost 25,000 registered drivers.

"Automobile row in New York in 1900 showed 14 different makes of cars; now there are 84 for you to select from.

"Ten years ago the average price of cars was \$1,100. Improvements in transmission, in greater simplicity and easier control, in increased power and in economy of fuel consumption, to say nothing of the ever increasing need of something to improve, to cheapen or to supplant the pneumatic tire, which, like the perpetual motion problem, has thus far seemed impossible of solution. It is the general opinion that the pneumatic tire will always be with us except for the very heavy vehicles, and while greatly improved in the past few years, it offers a fine opportunity for betterment.

"Now as to the use of motor cars. They are certain to increase in number, solely on account of their utility, without regard to pleasure use. Every farmer needs one, and the government reports show more than 5,000,000 farms in this country. We know that every doctor must have one and here are 7,700 in New York City alone, and 140,000 in the country.

"Every contractor, every suburban real estate agent, and if the truth be really told, every man, if not an owner now, hopes at some time to operate his own motor car.

"Constantly decreasing maintenance expense is making it possible for more and more people to own machines, even if for pleasure use alone. Moreover, in this great country of ours there are 997,000 families with an annual income of \$3,000 or more. It is believed that America will continue to buy annually 200,000 motor cars of all types, approximately that number having been sold during the past twelve months."

WILL MANUFACTURE A TRUCK.

The newest entrant into the St. Louis automobile field is the Brooks-Latta Auto Company. The incorporators are Charles Latta and Allen T. Latta. The two Lattas are heads of painting businesses. The company is capitalized for \$150,000 said to be fully paid. It is said by Mr. Latta that the company is to embark in the manufacture of automobile trucks as soon as the business can be organized.

STANDARD FOR JUDGING VEHICLES.

The South Australian Carriage and Wagon Builders' Association, as a guide to members officiating as judges of vehicles, discussed whether more points should not be allotted for design and finish than for each of the different branches of the trade. Finally the following, on a basis of a maximum of 50 points, was agreed upon: Woodwork, ironwork, painting, trimming, design, each ten points.

RECENTLY GRANTED PATENTS OF INTEREST TO THE VEHICLE INDUSTRY.

959,041—Vehicle Tire. Joseph Allend, Philadelphia, Pa.
 959,298—Steering Wheel for Automobiles. Roy E. Bowers, Hartville, Ohio, assignor to J. A. Bowers, Payette, Idaho.
 958,958—Shaft and Axle Crank. Charles Fremont, Paris, France.
 959,336—Vehicle Spring. Charles B. Geiger, Manning, S. C.
 958,811—Draft Equalizing Device. Alfred Hines, Wasco, Oregon.
 959,058—Wheel. John L. Jackson, River Forest, Ill.
 959,015—Wheel Hub. Charles J. Johnson, Longville, La.
 959,353—Tire. Alexander Kessler, Jr., Windom, Mo.
 959,361—Wagon Seat Fastener. Lewis M. Lattimore, Shubert Neb.
 959,236—Vehicle Rim. Adolph A. Ley, Akron, Ohio.
 959,791—Wind Shield. Emile J. Montigny, New York, N. Y.
 959,254—Buggy Shaft Tug. Walter G. Petree, Danbury, N. C.
 959,255—Wagon Jack. Stephen L. Porn, Rugby, N. D., assignor of one-half to H. Luth, Duluth, Minn.
 959,082—Singletree Attachment. George D. Simmons, Clarksdale, Miss.
 959,398—Adjustable Pattern for Tongue Hounds. Nathan J. Smith, Halstead, Kansas.
 959,279—Automatic Vehicle Brake. George W. Whitcomb, Duff, Neb.
 959,414—Fifth Wheel for Dump Wagons. Lorenzo H. Young, assignor of one-half to V. P. Hill, Hagerstown, Md.
 958,791—Wheel Guard. Jesse M. Yount, New York, N. Y.
 959,705—Vehicle Wheel. Arthur Brisbane, New York, N. Y.
 959,069—Adjustable Wagon Rack. John W. Brown, Nappane, Ind.
 959,070—Tire Lifter. John W. Brown, Arroyo Grande, California.
 959,457—Vehicle Tire. John W. Carhart, Austin, Texas.
 959,241—Dump Wagon. Wm. S. Coates, deceased, Jennie E. Coates, administratrix, assignor of one-half to Henry J. McCabe, Cedar Rapids, Iowa.
 959,001—Wheel Tire. Benjamin Dahl, assignor to Dahl Punctureless Tire Company, Minneapolis, Minn.
 959,433—Wagon Reach Adjuster. Wm. P. Dunlap, Maquoketa, Iowa.
 959,501—Whip Socket Lock. George Gable, Fairpoint, Ohio.
 959,165—Tank Wagon. Wm. and A. M. Graver, Chicago, Ill.
 959,732—Vehicle Wheel Rim. Wm. E. Greer, Kenmore, assignor of one-third to W. E. Pfeiffer, Akron, and one-third to J. Pfeiffer, Columbus, Ohio.
 959,935—Running Gear. Henry Higgin, assignor to the Higgin Manufacturing Company, Newport, Ky.
 959,176—Vehicle Spring. Abel M. Kindwall, Minot, N. D.
 959,790—Carriage Top Rest. Robert L. Norman, assignor to McKinnon Dash Company, Buffalo, N. Y.
 959,119—Automobile Tire. Howard S. Shafer, Nazareth, Pa.
 959,892—Vehicle Spring. Henry W. Smith, Canton, Ohio.
 959,126—Draft Equalizer. Jennings Van Matre, Paso Robles, Cal.
 959,128—Steering Gear. James R. Walker, Pine Ridge, S. D.
 959,212—Vehicle Wheel Tire. Fridrich Wiechard, Hanover, Germany.
 959,983—Singletree Hook. John E. Wiese, Spearville, Kas.
 959,784—Singletree Hook. Lewis J. Beard, Verna, Minn.
 959,802—Vending Wagon. Dad Boyle, Amarillo, Texas.
 959,629—Buggy Boot. Joseph E. Carroll, Portsmouth, Ohio.
 959,832—Hood for Motor or Other Vehicles. James S. Cree, Glasgow, Scotland.
 959,513—Vehicle Wheel. Joseph L. Day, Nashville, Okla.
 959,848—Sulky. James H. Dickson, Philadelphia, Pa.
 959,907—Steering Wheel for Automobiles. Edward K. Hardy, Akron, Ohio.
 959,326—Ruggy Top Clip. John C. Horn and J. M. Horn, Arba, Ind.
 959,338—Collapsible Hood or Canopy for Vehicles. John C. Kell and W. B. Allen, St. Louis, Mo.
 959,979—Vehicle Top. Herbert C. Martell, Flint, Mich.
 959,572—Transmission Gearing. Charles A. McKlearman, Carthage, Missouri.
 959,983—Separable Rim for Vehicle Wheels. Tod J. Mell, assignor to The Republic Rubber Company, Youngstown, Ohio.
 959,670—Wagon Bed Holst. Abraham Moyer, Movers, Okla.
 959,685—Wheeled Truck. George B. Norris, Columbus, Ohio, assignor to the Jeffrey Manufacturing Company.
 959,687—Draft Equalizer. Albert B. Olsen, Stearns, Mont.
 959,688—Driving Mechanism for Motor Vehicles. Freeman M. Olson, assignor to Commercial Motor Car and Engine Co., Chicago, Ill.
 959,579—Pneumatic Vehicle Gear. Louis J. Perkins, Lewiston, Idaho.
 959,460—Vehicle Wheel. John H. Watters, Augusta, Ga.
 959,749—Spring Wheel. Frederick Westerbeck, St. Louis, Mo.
 959,762—Speed Indicator. Frank W. Wood, Newport News, Va.
 959,676—Speedometer. Leon E. Blanchard, assignor to Reliance Speedometer Company, Boston, Mass.
 959,480—Supplementary Vehicle Seat. Frederick F. Breihan, Bartlett, Texas.
 959,482—Shoveling Board. Amos B. and M. A. Clippinger, Kansas City, Mo.
 959,494—Truck Brake. Elmon D. Harding, Montevideo, Minn.
 959,443—Tire. Reinhold Herman, Grafton, Pa.
 959,415—Sleigh Runner. Wm. Klaus, New Haven, Conn.
 959,248—Wagon Brake. Don Meek, Paonia, Colo.
 959,513—Draft Equalizer. Ezra J. D. Miller, Barlow, N. D.
 959,153—Tire Pump. Charles S. Myers, Columbia, Pa.
 959,532—Vehicle. John Reinehr, Savanna, Ill., assignor to Rail Laying Machine Co.
 959,372—Motor Vehicle. Albert F. Rockwell, assignor to the New Departure Manufacturing Company, Bristol, Conn.
 959,649—Draft Equalizer. Henry A. Schaub, Kearney, Neb.
 959,374—Tire for Vehicles. John C. Schleicher, Mount Vernon, N. Y.
 959,652—Self Dumping Apparatus. Jasper Scott, Arbutus, assignor of one-half to B. H. Newcomer, Spring Hill, W. Va.
 959,375—Separating Axle Couplings. Bagster R. Seabrook, Los Angeles, Cal.
 959,376—Differential Axle. Norman B. Seabrook, Los Angeles, Cal.
 959,559—Speed Indicator. Wesley Trafford, New York, N. Y.
 959,469—Sleigh. Wm. Walpole, Oxenden, Ont., Canada.
 40,721—Design. Jacob S. Hibschaum, Strausstown, Pa.

Copies of above patents may be obtained for fifteen cents each, by addressing John A. Saul, solicitor of patents, Fendall Building, Washington, D. C.

It is the outward appearance that everything develops spontaneously upward from a simple primordial substance.

THE TECHNICAL SCHOOL.

This is the season when young men looking for instruction in carriage drafting want to know what are the possibilities. It gives us pleasure to present the prospectus of the school for the present season. We need only add that any carriage mechanic who submits himself to the instruction of Professor Andrew F. Johnson, will become well grounded in the art, and if he excels, he will more than probably graduate into a fine paying position.

This school was founded and has been carried on by the Carriage Builders' National Association during the past twenty-nine years. It was opened in 1880 as an evening class only. The correspondence school was established in 1883, and the day school in 1892.

The school has its home in the Mechanics Institute, a fine building devoted to educational purposes and located at 20 West Forty-fourth street in New York City. The object is to teach men to design vehicles, and to make working drawings and fashion plates, and only those men employed in carriage, wagon or automobile building, or some of the accessory trades, are admitted to its privileges.

Fall term opened on the last Monday in September and closes for the Christmas holidays. Winter term opens the first Monday after January 1, and closes on April 10. The correspondence school is open the whole year round. Instruction in this department costs five dollars per term or fifteen dollars for the full course of three terms.

The day class is in session every week day, except Saturday, during the term, from 9:30 o'clock A. M. to 4:30 o'clock P. M. Evening class is in session from 7:30 to 9:30 P. M., every Monday, Wednesday and Friday during the term.

Applicants for admission to the day and evening classes must be able to read and write English, and must have a good knowledge of arithmetic. All employees of the carriage or accessory trades are admitted to the correspondence school without examination.

Ninety per cent. of the graduates are holding good positions in the carriage and automobile trade, and the demand for men trained in the school is constantly increasing.

Students in the Technical School for Carriage Draftsmen and Mechanics may, if they choose, take up studies other than those taught in this school, such as the study of engine details, drafting of gasoline engines, electrical work, mathematics, etc. These classes are conducted in the same building and the instruction is free.

For details as to courses of study in the Technical School for Carriage Draftsmen and Mechanics address Andrew F. Johnson, 20 West 44th street, New York city.

CLOSING DEAL.

A deal is being closed for the merger of the Baynes Carriage Co., the American Road Machine Co., of Canada, located in Goderich, and two Detroit motor car works. The merger will be known as the Acme Motor Carriage & Machinery Co., and the capitalization will be \$1,000,000. The manufacture of motor cars will be the special business of the new company and a large factory will be erected on the present site of the Baynes Carriage Co. The Goderich plant will be abandoned.

TIRE PLANT FOR ROANOKE.

The Roanoke (Va.) Times announces that within sixty or ninety days that city will have a factory for the manufacture of rubber tires and inner tubes for automobiles. R. Rowley, L. Powell and W. B. Lightfoot, New York people, are promoting the plan. Mr. Rowley has been for years interested in the mechanical engineering side of rubber manufacture and he has secured special patents for a machine which will greatly facilitate the manufacture of rubber goods. The Roanoke factory is to be equipped with this machine.

Trade News From Near and Far

NEW FIRMS AND INCORPORATIONS.

W. G. Meyers is opening a new stock of vehicles, etc., in Gold Hill, Ore.

L. Rector is soon to engage in the carriage business in Rockford, Mich.

W. A. Burroughs is opening a new stock of vehicles, etc., in Aurora, Mo.

J. B. Swain is opening a new stock of vehicles, etc., in Little Sioux, Iowa.

J. D. Hunt, of Culbertson, Mont., is building a vehicle store in Conrad, Mont.

F. A. Swarthout, of Jackson, Miss., has opened a wagon and carriage repair shop.

Geo. Talbott is preparing to opening a vehicle and harness store in Verona, Neb.

George Talbott is about to engage in the vehicle and implement business in Verona, Neb.

H. B. Mott and others are organizing a company to establish a buggy factory in Newnan, Ga.

T. D. & R. V. Wilkinson are planning the opening of a stock of vehicles in Rock Falls, Iowa.

Brown & Browning, of Appleton, Mo., are about to begin the erection of a carriage repository.

W. Gray & Sons Carriage Co., Chatham, Ont., has leased the premises in which to make automobile tops.

The Flint (Mich.) Auto Body and Specialty Company, with offices at 721 Brush street, is erecting a new building on Beach street.

The Havers Motor Car Co., at Port Huron, Mich., will soon commence operations on a large scale, and will open a factory employing 100 men.

Harry K. Flanders, Frank H. Flanders and E. L. King have organized as the Flanders Manufacturing Company, leased the O. J. Marsh shop at Titusville, Pa., and are ready to place upon the market a wind shield for automobiles.

Incorporations.

St. Louis, Mo.—Grand Motor Car Co.; capital, \$8,000.

Nashville, Tenn.—Marathon Auto Co.; capital, \$25,000.

Memphis, Tenn.—H. A. White Auto Co.; capital, \$40,000.

Portsmouth, Ohio—Carroll Vehicle Co.; capital, \$10,000.

Durham, N. C.—F. B. Lyon Motor Car Co.; capital, \$50,000.

Kansas City, Mo.—R. H. Collins Motor Co.; capital, \$50,000.

St. Louis, Mo.—Frank Goeke Motor Car Co.; capital \$5,000.

St. Louis, Mo.—The Rowmobile Mfg. Co.; capital, \$200,000.

St. Louis, Mo.—Southern Auto & Machinery Co.; capital, \$75,000.

Cheraw, S. C.—Rouse-Pegues Automobile Co.; capital, \$10,000.

San Antonio, Texas—The San Antonio Motor Car Co.; capital, \$15,000.

Oklahoma City, Okla.—The McCool Mercer Motor Co.; incorporated with capital of \$10,000.

Delphos, Ohio—Mueller Implement & Auto Co.; capital, \$75,000; by John Mueller and others.

Cleveland, Ohio—Militaire Auto Co.; capital \$300,000; by M. L. Thomas, G. A. Gaston and others.

Denver, Colo.—Mann-Aldrich Carriage Co.; capital \$8,000; by F. C. Mann, H. L. Aldrich and others.

Washington, D. C.—National Wagon Co.; capital \$100,000; by C. P. Keller, A. D. Phillips, J. M. Wheatley.

Louisville, Ky.—Electric Vehicle Co.; capital, \$10,000; by H. B. Hewitt, P. E. Allison, E. M. Drummond.

Union City, Ind.—Back Stay Machine & Leather Co.; capital

stock, \$120,000; to manufacture car and carriage machinery and parts. Directors: R. C. Schemmel, R. L. Hill and B. P. Southard.

Hopkinsville, Ky.—Ideal Motor Car Co.; capital, \$10,000; by C. C. Jackson, Wm. Kimmons, Sam Frankel.

Toledo, Ohio—Dusseau Fore & Rear Drive Auto Co.; capital stock, \$100,000; by D. V. Dusseau and others.

Cape Girardeau, Mo.—Southwest Motor Car Co.; capital, \$15,000; by E. M. Rowe, J. W. Phillips and Geo. McBride.

Newark, N. J.—Wilson Motor Car Co.; capital \$25,000; by S. F. Wilson, J. Foley and others, to manufacture motors.

Hartsville, S. C.—Pageland Buggy & Wagon Co.; capital, \$5,000; by S. E. Askins and H. W. Crosswell, of Hartsville.

Denver, Colo.—Crawford-Sauler Spring Tire Co.; by Guy H. Crawford, George Sauer, T. M. McCartney, capital, \$10,000.

Buffalo, N. Y.—Richardson Auto-Tire Protector Co.; capital, \$100,000; by J. Richardson, O. Richardson and Valentine Hoefner.

Vinton, Iowa—First Implement & Automobile Co.; capital, \$20,000; by J. P. Whitney, Charles Henderson and C. J. Santmyer.

Indianapolis, Ind.—Hamner Mfg. Co.; capital, \$10,000; to manufacture vehicles; by John S. Hamner, Roscoe S. Parr and John H. Allen.

Mason City, Iowa—Colby Motor Company; capital, \$1,000,000. W. S. Colby, president. Will start manufacturing as soon as building can be erected.

Dayton, Ohio—Montgomery County Auto Co.; capital, \$15,000; by H. G. Wiley, S. A. Long, A. M. Klepinger, C. E. Foreman and P. M. Klepinger.

Buffalo, N. Y.—Hays-Schoepflin Co., capital, \$10,000; to manufacture automobiles and auto trucks, by Walter Hays, B. I. Hays, Louis B. Schoepflin, L. O. Schoepflin.

Chicago, Ill.—Clank Delivery Car Co.; capital, \$5,000; to manufacture and deal in auto delivery cars and supplies; by Albert C. Clark, Akmon W. Bulkley and Joseph F. Gillen.

Newark, N. J.—Vroom & Co., to manufacture coaches, carriages, etc.; capital, \$25,000; by Chas. W. Smalley and William Ward, South Orange, N. J., and Peter Vroom, Orange.

BUSINESS CHANGES.

Galt Bros. have purchased the business of Kelliher Bros., in Stanford, Mont.

Mort Cobb has purchased the Spencer stock of vehicles, etc., in Valley Falls, Kas.

F. O. Allen has purchased the stock of vehicles, etc., of M. C. Corley, in Harper, Kas.

Harry Witten has purchased the vehicle business of Dr. T. J. Collins, in Trenton, Mo.

W. C. Hitchens has disposed of his stock of vehicles, etc in Ute, Neb., to F. A. Vore.

Charles Niles has disposed of his vehicle business in Tilden, Neb., to Cunningham Bros.

Charles Baker & Son, implements, etc., have sold out to E. E. Gaumitz, at Waterloo, Iowa.

James Law has purchased the stock of vehicles, etc., of Frank Robinson, in Audubon, Iowa.

R. S. Nelson has disposed of his stock of vehicles, etc., in Brayton, Iowa, to Mr. Conley.

D. C. Jones has disposed of his stock of buggies, etc., in Depere, Wis., to Ben Leist & Son.

The corporation heretofore known as the A. W. Whitaker Buggy & Harness Company, Memphis, Tenn., will hereafter

be known as A. W. Whitaker & Company. The incorporators of the company are A. W. Whitaker, Theo. Hall, J. E. McCaul, E. P. Gouglas and R. J. Hawk.

F. A. Kerstrong has disposed of his stock of carriages, etc., in Wentzville, Mo., to J. D. Henke.

J. L. Brugman has purchased the stock of vehicles, etc., of J. S. Fisher, in Lone Tree, Iowa.

J. M. Bovee & Son have purchased the stock of buggies, etc., of W. C. Freeman, in Craig, Neb.

Charles E. Justice has succeeded Wirt & Justice in the carriage business in Clarksville, Mich.

George Nixon has succeeded to the stock of vehicles, etc., of Nixon & Washburn, in Downs, Kas.

J. T. Barnes has disposed of his stock of vehicles, etc., in Emerson, Iowa, to Myron Shipman.

Nordgren & Paulson have purchased the vehicle business of Wm. Olson, in Walnut Grove, Minn.

O. E. Bonecutter has disposed of his stock of vehicles, etc., in Maple Hill, Kas., to C. P. Banker.

At Sac City, Iowa, Charles Prentice, late of Early, has sold his wagon business to Harry Sampers.

John A. Berry, Elmira, N. Y., will move his coach and cab manufacturing business to Athens, Pa.

A. C. Ryan, of Waterloo, Ia., has purchased the vehicle business of B. E. Fogt, in Reinbeck, Iowa.

R. D. Parker has purchased the stock of buggies, etc., of the Wolf Implement Co., in Dallas, S. D.

R. O. McAnnich & Son have sold out their stock of vehicles, etc., in Riley, Kas., to Julius Weisendanger.

At Harlan, Iowa, H. W. Nieman, dealer in implements, etc., has traded his business to Louis Christensen.

Hamilton & Allingham have disposed of their stock of vehicles, etc., in Manhattan, Kas., to Oscar Rice.

Satree & Weeks have purchased the stock of buggies, etc., of Johnson & Neilson, in Newman Grove, Neb.

C. L. Schiefelbein, of Ithaca, Neb., has purchased the stock of vehicles, etc., of B. M. Gilbert, in Wann, Neb.

At Plum City, Wis., Wm. Lantz, hardware, implements, etc., has sold out to Aug. Schwedes & John Swanson.

C. O. Burke, of Central City, Neb., has purchased the stock of vehicles, etc., of E. C. Carlson, in Stanton, Iowa.

O. A. Kalverstran has purchased the stock of vehicles and implements of J. W. McCullick, in Gays Mills, Wis.

Ed. Durband has sold out his stock of vehicles, etc., in Le Mars, Iowa, to Hugh Daily, who will add automobiles.

S. A. Dwight, Grand Rapids, Mich., has purchased the interest of J. McLaren in the auto and supply business in that place.

The Bryden & Odgers Carriage Co., Denver, Colo., has perfected a consolidation with the Denver Omnibus and Cab Co. and will be located in the new and commodious building of the latter.

The Magnolia Carriage Company, Houston, Texas., successors to Spencer & Noack, is now owned by the firm composed of J. L. Durham, John J. G. Spencer and Hugo A. Noack, all of whom are thoroughly experienced in the carriage business. The building occupied by the Magnolia Carriage Company is an ironclad building with all machinery necessary.

The board of directors of the D. M. Sechler Carriage Company, Moline, Ill., voted unanimously to change the name of the manufacturing concern to D. M. Sechler Implement and Carriage Company. The company has for some time been turning out a large amount of implements, but despite this fact the present name causes the uninformed to think it manufactures only carriages. The stockholders will be asked to ratify the same.

IMPROVEMENTS—EXTENSIONS.

Studebaker Company leased for five years, from George Ehret, six stores in the Fifty-ninth street, New York frontage of the new two-story building now being erected in the east side

of Broadway from Fifty-eighth to Fifty-ninth street. The space will be used for offices and show rooms. The same company recently leased the store, basement and four lofts in the Randall Building, Nos. 136 to 146 West Fifty-second street, to be used as salesrooms.

Bigham Implement Co., Miami, Okla., increased capital from \$5,000 to \$25,000.

Auto Equipment Co., Detroit, Mich., increased capital from \$50,000 to \$75,000.

Wright Carriage Body Company, Moline, Ill., capital increased from \$100,000 to \$150,000.

The Florence Wagon Works, of Florence, Ala., will establish a wagon factory in Pensacola, Fla.

Jerome Bolick & Son are about to improve their carriage manufacturing plant in Newton, N. C.

The New Way Motor Co., of Lansing, Mich., has increased its capital stock from \$100,000 to \$350,000.

Stephen Schultz has moved his stock of vehicles and automobiles in Hastings, Neb., into a new building.

C. P. McCreary, of Grand Junction, Colo., is building an addition to his implement and vehicle establishment.

The capital stock of the Hudson Motor Car Co., in Detroit, Mich., has been increased from \$100,000 to \$1,000,000.

The Consolidated Wagon and Machine Company, Rexburg, Idaho, is erecting a new two-story business house to be occupied by the company.

The fine new building of the Eller Wagon Works at Commerce and Caroline streets, Houston, Texas, is about finished and will soon be occupied.

The Seymour (Ind.) Manufacturing Company has completed plans for building a large addition and making other improvements at its spoke factory.

Anchor Buggy Co., Cincinnati, O., has incorporated with a capital of \$400,000. Incorporators: Anthony G. Brunsmann, E. Klansmeyer, Earl M. Galbraith, W. J. Brunsmann, S. E. Schroth.

Moon Motor Car Company, St. Louis, Mo., has leased for five years a store in the Fifty-eighth street side of the Ehret Building, New York, which will be ready for occupancy by January 1, at a stated rental of \$4,000 per annum.

The new hardwood mill, constructed at Huttig by the Wisconsin Lumber Company, of Chicago, has commenced sawing. The mill has a capacity of 100,000 feet daily, and will manufacture wagon stock, including poles, reaches, sawed felloes, bolsters, sand boards, hubs, axles, spokes, etc.

BUSINESS TROUBLES.

The Velie Motor Vehicle Company, of Moline, Ill., won a victory in its suit against the alleged automobile trust, when the supreme court at Madison, Wis., handed down a decision denying the defendants a writ of prohibition restraining any further proceedings in the case.

The four remaining defendants tried to have suit dismissed on the ground that the service of the summons and complaint which had been made on the managers of their Milwaukee agencies, was illegal. Their petition was denied and they then tried to get the writ of prohibition from the supreme court.

Sumner Healey, carriage and automobile builder at Mount Vernon, N. Y., has filed a petition in bankruptcy, with liabilities of \$20,054 and no assets. Among the creditors are Robert J. F. Schwarzenbach, New York, \$15,711, money loaned, and John A. Joachim, \$2,000, claim for damages for assault and battery suit.

The Velie company brought suit several months ago against over thirty automobile concerns, which are alleged to be in a conspiracy to injure its business. On a subsequent proceeding the court reduced the number of defendants to four—the Pierce Motor Car company, the Chalmers-Detroit Motor company, the Locomobile Company of America and the Pope Manufacturing company.

The demurrer of the Kopmeier Motor Car Company, Milwaukee, in the action brought by the Velie Motor Vehicle Com-

pany averred that the Kopmeier Company had failed to take the because of alleged breach of contract, has been sustained. The local concern maintained that instead of a sales contract a contract for agency only existed between the two concerns, but that the Velie Company had reserved the right to revoke the contract, a right which had not been given the defendant. On this showing the court sustained the demurrer. The Velie Company averred that the Kopmeier Company had failed to take the fifty cars contracted for in the alleged agreement.

Eward O. Barten has been appointed receiver of the Zapf Wagon and Lumber Company, at North Bend, Ohio, as the result of a suit filed by Samuel P. Suit, a stockholder and creditor. Suit is the owner of 15 shares of stock in the company, which is a \$10,000 corporation. In addition to this he is a creditor to the amount of \$8 for material furnished and indorser on a note of \$500. He says that while the firm is wholly solvent and its liabilities amount in not over \$2,215.75, of this amount \$1,277.17 is past due and the company is unable to meet the indebtedness, it is claimed the company can pay out and get on its feet if threatened suits are prevented from tying it up, and the receiver was asked for this purpose.

The exceptions to the auditor's report in the equity proceedings of Hoopes Bros. & Darlington, West Chester, Pa., against the Keystone Wagon Works, are sustained by Judge Endlich, and distribution made by him is directed to be revised and modified accordingly. Agents brought two suits against the receiver of the defendant company, for the recovery of commissions for the sale of auto bodies. In the first, a verdict was rendered for the plaintiff for \$1451.98 and judgment entered thereon. In the second, a verdict having been rendered for plaintiff, judgment was subsequently entered in favor of the defendant, which was affirmed upon appeal. The court concludes that the first ground of exception to the auditor's allowances of Bradenberg & Co.'s claim is well taken.

FIRES.

The Fisher Carriage & Wagon Works, of Sedalia, Mo., has suffered a fire loss.

The Milburn Wagon Co., Nashville, Tenn., damaged by fire; loss \$10,000 on stock.

Fire destroyed Hilbeit's carriage and paint shop at Warrenton, Va., on October 29.

The stock of vehicles and implements of George Morrison, in Ewart, Iowa, has been damaged by fire.

The stock of vehicles, etc., of the Wilmer-Dwyer-Helmer Co. in Shortas, Wash., has been destroyed by fire. Loss, \$10,000.

Two carloads of buggies belonging to the Buchanan-Lyon Buggy Co., Campbellsville, Ky., were destroyed by fire in a storeroom on October 25.

Two-thirds of the plant of H. D. Smith & Company at Plantsville, Conn., one of the largest manufactories of carriage hardware in the country, was destroyed by fire Oct. 31 with a loss of \$200,000.

Thirty-two partly finished automobiles were burned in a fire which for a time threatened the entire factory of the Diamond Automobile Company, South Bend, Ind. The flames were confined to the paint shop, but this building was burned to the ground. The total loss is placed at approximately \$50,000, with insurance of \$10,000.

The destruction by fire of the carriage factory of Arthur S. Fillmore, at Athol, N. S., destroyed one of the largest and best equipped shops in Eastern Canada, Mr. Fillmore's output being about \$14,000 per month. Two hundred sleighs were under construction, and about ready for shipment. These, with all raw material, machinery, patterns, etc., were completely destroyed, entailing a loss of \$35,000. The insurance will amount to from \$7,000 to \$10,000.

We are what we feed upon, and false doctrines beget false lives.

PERSONALS.

Rumors that Staver Carriage Co. was buying out Streator Motor concern are positively denied by Mr. Barlow.

The Implement, Vehicle and Hardware Club in Peoria held its first of the season meeting in October; followed with a dinner.

Christ. Wesp, long proprietor of the King Spring & Gear Co., has gone with Moller & Schumann Co. He will travel in the Southern States.

Rauch & Lang Company, of Cleveland, O., those sterling carriage builders, participated with their work in an auto parade and scooped most of the prizes.

Arthur I. Sage, of A. J. Sage & Co., Melbourne, Australia, is in this country at present looking about at the trade. He was a visitor at the carriage convention.

W. N. Agnew, traffic manager of the Durant-Dort Carriage Co., Flint, Mich., has resigned to accept the traffic managership of the International Pump Co., with headquarters in New York.

H. V. Goodenough, general foreman for Schubert Bros. Gear Co., Oneida, N. Y., has accepted the position of superintendent for the R. N. Collins Auto and Carriage Woodwork Co., of St. Louis, Mo.

Russell Gardner has gone on a game (big) hunt in Mexico. He is actually going to trundle around the country in a hunting wagon built in his Ozark factory. Mr. Gardner is known and admired for his nerve and bravery.

L. F. Maire, international president of the carriage and wagon workers' union, and William P. Mervin, of Buffalo, general secretary-treasurer, spoke at an open mass meeting of all carriage, wagon and automobile workers of Boston and vicinity at Wells Memorial Building.

At a meeting of the directors of the H. H. Babcock Carriage Co., Watertown, N. Y., the following officers were elected: President, George H. Babcock; vice-president and treasurer, William J. Mills; secretary, William R. Tasse. At a meeting of the stockholders the following directors were elected: George H. Babcock, D. M. Anderson, R. J. Buck, George F. Clark, Fred George and W. J. Mills. The stockholders discussed automobile prospects and the company is getting in shape for a big output of machines next year.

George A. Yule, of Kenosha, Wis., was re-elected president and general manager of the Racine-Sattley Company, Racine, Wis., at the annual meeting of directors and stockholders held at Springfield, Ill. Mr. Yule became president and general manager nearly a year ago, succeeding Herbert E. Miles. The largest stockholder, William Bigelow, of Milwaukee, Wis., was elected, vice-president; Thomas Kearney, Racine, treasurer, and George B. Lowrie, Racine, secretary. Charles N. Jillett, of the First National Bank, Chicago; William A. Tilden, of the Dearborn National Bank, Chicago, and R. Nausten, of the Girard National Bank, of Philadelphia, were elected directors.

AEROPLANE TIRES.

The Palmer aeroplane tire, manufactured by the B. F. Goodrich Co., Akron, Ohio, is meeting the unique demands of aviation. It is a patented tire, manufactured exclusively by this company. The aeroplane tires are light, durable and resilient for easy landing. Each of the four plies is wound so that the three of one ply are at an angle of 45 degrees to those of another. Each thread is embedded separately in pure rubber. This substitution for interwoven fabric gives the Palmer tire the greatest amount of bouyancy and resilience. This tire is about 25 per cent lighter than any other single-tube tire. Weight is a great drawback to the efficiency of the aeroplane. The aeroplane tire made by the Goodrich Company is not an experiment, as it has been the object of long and careful tests, proving reliability in actual use. Glen H. Curtis, who has won international cups, says the Palmer tire absorbs the shocks of alighting, saves the machinery and does not disturb the adjustment of the planes.

OBITUARY

William J. Dalton died at the home of his sister, Mrs. A. Taylor, in Bushnell, Ill. He had been failing in health for some time. He leaves three sisters and one brother. Mr. Dalton was a carriage trimmer by trade. He was 42 years of age.

William J. Hutchinson, 59, for 17 years purchasing agent for the St. Marys (O.) Wheel & Spoke Works, died suddenly Oct. 27 from a stroke of apoplexy. The stroke followed a life of rugged health. He attended to his customary duties the evening preceding his death. The widow and two children survive.

Frederick C. Winkler, of South Bend, Ind., died October 11 after a six-weeks' illness. Mr. Winkler was president of the Winkler Bros. Mfg. Co. He had been in poor health for more than a year, but it was only during the last few weeks that his condition became alarming. His death was the result of Bright's disease, made more acute through complications. He learned the wagon and carriage builders' trade at Niles, Mich., and in 1877 with his brother Lenhart engaged in the manufacturing business at what is known as Truitt's Corners in Cass County, Mich. After three years spent in establishing their business, the brothers decided to locate their plant in South Bend. In 1902 the Winkler Bros. Mfg. Co. was incorporated. Mrs. Winkler, with five children, survives.

THE MANUFACTURERS' ASSOCIATION AT ST. LOUIS.

The seventeenth annual convention of the National Association of Agricultural Implement and Vehicle Manufacturers was held in St. Louis, Mo., November 1, 2 and 3. The most important business transacted was the approval of the proposed consolidation of this and other associations of implement and vehicle manufacturers. The plan met with some opposition, but the motion to adopt was carried by a large majority.

This action will give the industry a large and powerful organization from which members will receive valuable service at all times. The association will continue in its present form and without change in constitution or by-laws until the amalgamation of the different organizations has been effected. The consolidation probably will be completed by January 1, 1911. Chicago was selected as the next meeting place. The following officers were elected:

President—Edwin D. Metcalf, Auburn, N. Y.

Treasurer—C. A. Pattison, Peoria, Ill.

Chairman Executive Committee—Frank C. Johnson, Springfield, Ohio.

Members Executive Committee for three years—C. S. Brantingham, Rockford, Ill.; Wm. Butterworth, Moline, Ill.; Jos. Dain, Ottumwa, Iowa. Member of Executive Committee for two years: L. D. Collins, Batavia, N. Y.

Vice-Presidents—W. A. Taylor, Niles & Scott Company, La-Porte, Ind.; Wm. Loudon, Loudon Machinery Company, Fairfield, Ia.; S. M. Nones, Kentucky Wagon Manufacturing Company, Louisville, Ky.; E. P. Curtis, Richardson Manufacturing Company, Worcester, Mass.; B. T. Skinner, Advance Thresher Company, Battle Creek, Mich.; A. T. Stevens, John Deere Plow Company, St. Louis, Mo.; Richard Graves, Ohio Rake Company, Dayton, O.; R. S. Buch, A. Buch's Sons Company, Elizabethtown, Pa.; J. S. Baker, Baker Manufacturing Company, Evansville, Wis.; Fred. H. Bateman, Bateman Manufacturing Company, Grenloch, N. J.; Judson Buchanan, Chattanooga Plow Company, Chattanooga, Tenn.; C. P. Dempster, Dempster Mill Manufacturing Company, Beatrice, Neb.

REMOVAL.

The Philadelphia branch of Consolidated Rubber Tire Co. has been removed from 315 to 208 North Broad street. Manager Kissel's work has resulted in such a large increase in the sale of Kelly-Springfield tires that larger quarters became a necessity.

DUAL TIRES.

The possibility of puncture or blow-out makes the ordinary pneumatic tire somewhat dangerous, but a dual tire with demountable rims has been designed to do away with most objections. The dual feature consists of two pneumatic tires mounted side by side. An injury to one tire is unlikely to affect the other, as the load can be carried on the good tire until an opportunity for substituting a new tire for the injured one occurs. To remove one of the tires it is necessary to loosen eight nuts and slip the demountable rim off. Substitute tires may be already blown up, ready to slip on when needed.

AUTOMOBILE TRUNK.

The illustration used is to show a new automobile trunk that has the feature of lightness to recommend it.

This trunk is made of basswood, as shown, covered with five-ounce patent leather. The box is lined with stout plaid linen.



View Showing Trays.

Two or three cases fit the interior, three cases being shown in illustration. It can be seen that the cases may be removed independently of each other. A waterproof covering enclosing the whole is also supplied. The trunk is made by John Boyle & Co, of New York City, whose name is a reputation in itself.

Wants

Help and situation wanted advertisements, one cent a word; all other advertisements in this department, 5 cents a word. Initials and figures count as words. Minimum price, 30 cents for each advertisement.

POSITION WANTED.

Position Wanted—Carriage painter wishes job in small custom shop, to take charge; is all round man, striper and finisher. Address W. A. R., care The Hub, 24 Murray St. New York City

HELP WANTED.

Wanted—A first class sales manager for buggies and farm wagons for Southern states. Must have first class record and references. Address B, care The Hub, 24 Murray street, New York City.

PATENTS.

Patents—H. W. T. Jenner, patent attorney and mechanical expert, 608 F St., Washington, D. C. Established 1883. I make a free examination and report if a patent can be had and exactly what it will cost. Send for circular.

The TIMKEN ROLLER BEARING CO.

MAKERS OF TIMKEN ROLLER BEARING AXLES
for WAGONS and CARRIAGES



Canton, Ohio

A Set of
TIMKEN AXLES
will save your
CUSTOMERS
these two horses

This statement is based on the experience of thousands of users.

New Catalog and Price List upon application.

THE TIMKEN ROLLER BEARING CO.,
CANTON, OHIO,

BRANCHES- 10 E. 31 st Street, New York.
429 Wabash Avenue, Chicago.

HANDY LAMP GASOLINE LIGHTING SYSTEM

Draws Trade to Your Shop.

Gives a 300 Candle Power Shadowless Light the instant you move the lever. Turns up or down, like gas, burns dim when not in use, or can be turned up instantly when more light is needed. It floods a 30-foot space with a brilliancy like daylight. Far cheaper than gas, kerosene or electricity, and so simple that anyone can use it. You can depend on it for years for any purpose demanding a big, strong light. Catalogue H tells why: Send for it now.



BRILLIANT GAS LAMP CO.

DEPT. 29. 42 STATE ST. CHICAGO, ILL.



E. SCOTT PAYNE CO.;
OF BALTIMORE CITY
CARRIAGE AND AUTOMOBILE
HARDWARE

362 and 364 North Gay Street,
BALTIMORE, MD.

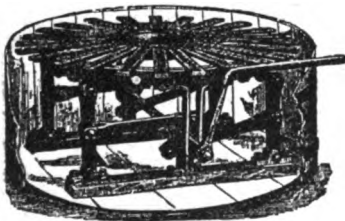

The Bokop Tire Setter and Cooler
Is the Best and Only Machine
that has stood the test during
the last 12 years on all classes of
work, and is the Only Machine
built with the Indestructible
Wrought Iron Face Plate.

Over 1,000 are in successful operation, repairs on which have not exceeded \$6.00 in the last 12 years. For prices, references and descriptive circulars, address
BOKOP, WEBB & PALM,
Defiance, Ohio

CARRIAGE SPRINGS OF EVERY STYLE AND PAT- TERN TO ORDER

Also Curtain Rollers and Concealed Hinges

EXCLUSIVELY FIRST-CLASS WORK

THE BEST THAT CAN BE MADE

SPRING PERCH CO.

BRIDGEPORT, CONN.

Please mention "The Hub" when you write.

HOTEL CUMBERLAND

NEW YORK

Southwest Cor. Broadway at Fifty-fourth St
Near 50th St. Subway Station, 53d St. Elevated and all Surface Lines.



Headquarters for
Carriage and
Automobile Trade

Ideal Location, Near Theatres,
Shops and Central Park.

NEW AND FIREPROOF
STRICTLY FIRST-CLASS

RATES REASONABLE
All Hardwood Floors and
Oriental Rugs.

Ten Minutes Walk to
Twenty Theatres.

Transient Rates, \$2.50 with Bath, and up.

Excellent Restaurant. Prices Moderate.

SEND FOR BOOKLET.

HARRY P. STIMSON,
Formerly with Hotel Imperial.

R. J. BINGHAM,
Formerly with Hotel Woodward.

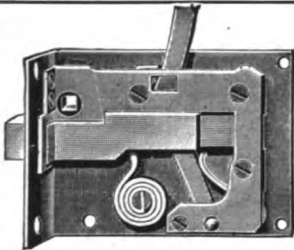

A. OCHSNER & SONS CO.
NEW HAVEN, CONN.

Auto and Carriage
Locks, Hinges, Etc.

Every Vehicle Dealer Should Read

The Hub

\$2.00 a year. Trade News Pub. Co., New York, N.Y.

ESTABLISHED 1886.

Correspondence School of Carriage and Motor Carriage Drafting

A thorough, practical tuition is given through this correspondence school. The theory and practice of construction, bookkeeping, perspective. Many men now hold good positions through taking the courses of instruction.

Principal, THOS. MATTISON,
Hillside Avenue, Bitterne Park,
Southampton, England.

Author of "The Coach Body Makers' Guide," \$3.00; a practical treatise on "The Suspension of Carriages," "Bookkeeping," and other carriage building works.

INDEX TO ADVERTISEMENTS.

| | |
|------------------------------------------------|-----------|
| American Ball Bearing Co., The | 2nd cover |
| American Roller Bearing Fifth Wheel Co. | 18 |
| Ault & Wiborg Co., The | 3 |
| Bailey & Co., Inc., S. R. | 16 |
| Bokop, Webb & Palm | 11 |
| Bennett Mfg. Co. | 3 |
| Brilliant Gas Lamp Co. | 11 |
| Cately & Ettling | 2 |
| Columbus Bolt Works | 4th cover |
| Consolidated Rubber Tire Co. | 1 |
| Cortland Forging Co. | 17 |
| Crane & MacMahon | 2nd cover |
| Devoe, F. W., & Reynolds Co., C. T. | 3rd cover |
| Eberly & Orris Mfg. Co. | 3rd cover |
| Eccles Co., Richard | 16 |
| Frantz Body Mfg. Co., The | 3 |
| Gifford & Son, John A. | 11 |
| Goodrich Co., B. F., The | 5 |
| Goshen Eyelet Co. | 14 |
| Gramm Motor Car Co., The | 3 |
| Higgin Mfg. Co. | 13 |
| Hoopes Bro. & Darlington, Inc. | 2nd cover |
| Indianapolis Dash Co. | 2 |
| Jones & Co., Phineas | 6 |
| Keystone Paint & Filler Co. | 4 |
| Keystone Forging Co. | 16 |
| Keystone Spring Works | 13 |
| Kilvington, S. W. | 16 |
| Kimble, Andrew | 4 |
| Masury & Son, John W. | 2 |
| McKinnon Dash Co. | 4th cover |
| Mercer, Geo. J. | 18 |
| Moller & Schuman Co. | 6 |
| Mott Wheel Works | 3rd cover |
| Murphy Varnish Co. | 4 |
| National Aluminum & Bronze Co. | 3rd cover |
| New Wapakoneta Wheel Co., The | 4th cover |
| Ochsner & Sons Co., A. | 12 |
| Payne Co., E. Scott | 11 |
| Porter, H. K. | 16 |
| Russell, Burdsall & Ward Bolt and Nut Co. | 3rd cover |
| Schubert Bros. Gear Co. | 16 |
| Shortsville Wheel Co. | 13 |
| Smith & Co., Edw. | 6 |
| Spring Perch Co. | 11 |
| Standard Oil Cloth Co. | 18 |
| Standard Wheel Co. | 17 |
| Timken Roller Bearing Co. | 11 |
| Uebelmesser Co., Charles R. | 14 |
| Valentine & Company | 6 |
| West Tire Setter Co. | 2 |
| Wilcox Mfg. Co., D. | 15 |
| Willey Co., C. A. | 4 |
| Woodman, Joel H. | 14 |

Please mention "The Hub" when you write.

The HIGGIN Line of Carra gé Trimmings

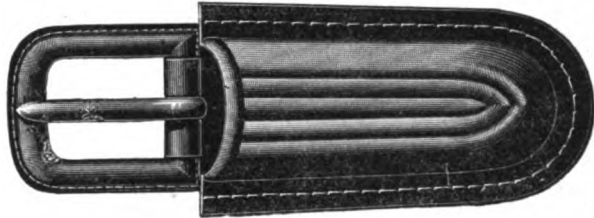

No. 8.—Leather Buckle Loop.

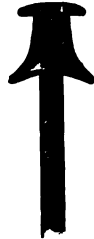

No. 70.



No. 74.



No. 72.

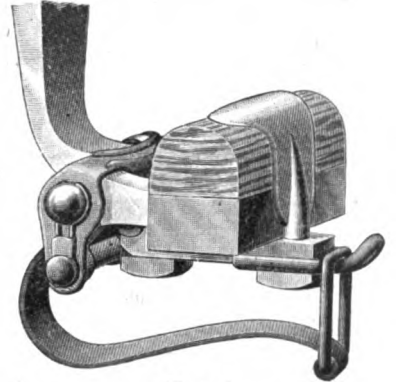

Closed
The Higgin Quick Shifter.



No. 13—Black Japan Nut.



Full Leather.



No. 130
KNOBS FOR ALL PURPOSES.



No. 133

QUALITY UNSURPASSED

Send for catalogue and get acquainted with our line.

THE HIGGIN MANUFACTURING CO.



Wrought Steel Prop.

NEWPORT, Ky.

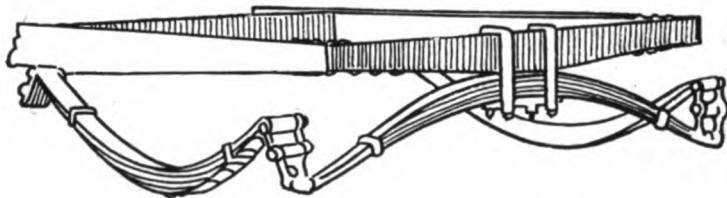

Automobile Wagon and Truck SPRINGS

KEYSTONE SPRING WORKS, Inc.

1301-11 Buttonwood Street

PHILADELPHIA, PA

EXAMINE CAREFULLY

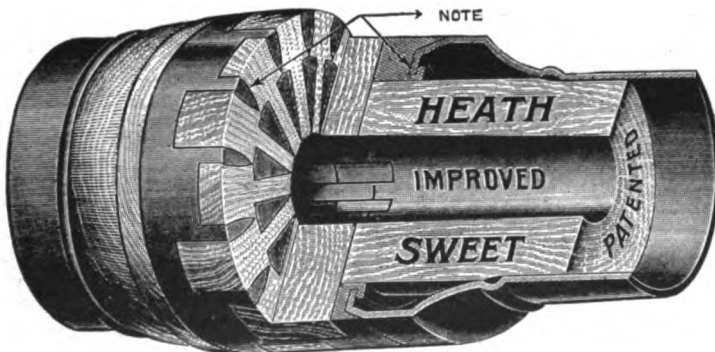

HEATH HUB

You Won't Find a Flaw

Manufacture also

SWEET SARVEN

KENNEY SHELL

WARNER OOD

and

AUTOMOBILE WHEELS

Shortsville Wheel Co.,

Shortsville, New York

Please mention "The Hub" when you write.



Painters and Decorators Save Time, Labor and Money, using the

Uebelmesser Striping and Stencil Wheel

With this simple, clean and rapid-action tool the most ordinary decorator can do the finest striping and stencil work and produce a bigger day's work with less labor than by the old fashioned method. Complete directions are furnished with each tool. They are as simple as the tool itself.

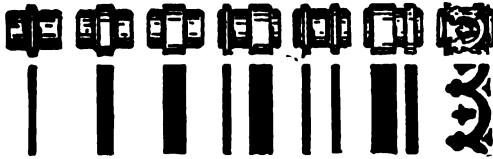

Just a few of the many designs that can be produced with the Uebelmesser Painters' and Decorators' Tool. (The designs shown above are reduced in size)

Complete Outfit consisting of Machine, 10 Plain and 10 Ornamental Wheels, only . . . **\$5.50**
LIBERAL DISCOUNT TO THE TRADE

Manufactured by
Charles R. Uebelmesser Company
Bayside, New York, N. Y.

Advertisements Classified

The following list includes advertisers in THE HUB. Each advertiser is entitled to name under one heady only. An extra charge for name under more than one heading.

Automobiles

Auto-Bug Co., The, Norwalk, O.
Pullman Motor Car Co., York, Pa.

Axles, Etc.

American Ball Bearing Co., Cleveland, Ohio.
Keagy & Lear Machine Co., Coshocton, Ohio.
Timken Roller Bearing Co., Canton, Ohio.

Bodies, Seats, Etc.

Frantz Body Mfg. Co., The Akron, Ohio.
Kilvington, S. W. Wilmington, Del.
Woodman, Joel H., Hoboken, New Jersey.

Bolts and Nuts.

Columbus Bolt Works, Columbus, Ohio.
Milton Mfg. Co., Milton, Pa.
Russell, Burdall & Ward Bolt and Nut Co., Port Chester, N. Y.

Carriage Forgings.

Columbus Bolt Works, Columbus, Ohio.
Eccles Co., Richard, Auburn, N. Y.
Keystone Forging Co., Northumberland, Pa.

Carriage Hardware.

Cately & Etting, Cortland, NY
Cleveland Hardware Co., The, Cleveland, Ohio.
Eberhard Mfg. Co., The, Cleveland, Ohio.
Gifford & Son, John A., New York.
Ochsner & Sons Co., A., New Haven, Conn.
Payne Co., E. Scott, Baltimore, Md.

Carriage Goods.

Gifford & Son, John A., New York.
Higgin Mfg. Co., Newport, Ky.

Dashes, Fenders, Rails, Etc.

Bennett Mfg. Co., Alden, N.Y.
Indianapolis Dash Co., Indianapolis, Ind.
McKinnon Dash Co., Buffalo, N. Y.

Fifth Wheels.

American Roller Bearing Fifth Wheel Co., Brooklyn, N. Y.
Wilcox Mfg. Co., D., Mechanicsburg, Pa.

Finished Vehicles.

Bailey & Co., Inc., S. R. Amesbury, Mass.
Staver Carriage Co., Chicago, Ill.

Gear Irons

Wilcox Mfg. Co., D., Mechanicsburg, Pa.

Gear Woods.

Andrew Kimble, Zanesville, O.

Lamps.

Brilliant Gas Lamp Co., Chicago, Ill.
Gifford & Son, John A., New York.

Motor Trucks.

Gramm Motor Car Co., The Bowling Green, O.

Machinery and Tools.

Bokop, Webb & Palm, Defiance, Ohio.
Porter, H. K., Everett, Mass.
West Tire Setter Co., Rochester, N. Y.

Miscellaneous.

Goshen Eyelet Co., Goshen, Ind.
National Aluminum & Bronze Co., Indianapolis, Ind.
Standard Oil Cloth Co., New York.
Uebelmesser Co., Charles R. Bayside, New York, N. Y.

Rubber Tires.

Consolidated Rubber Tire Co., New York City.
Goodrich Co., B. F., Akron, O.

Shaft Couplings and Anti-Rattlers.

Eccles Co., Richard, Auburn, N. Y.
Metal Stamping Co., New York City.

Springs and Gears.

Keystone Spring Works, Inc., Philadelphia, Pa.

Spring Perch Co., Bridgeport, Conn.

Varnishes, Paints and Japans.

The Ault & Wiborg Co., Cincinnati, Ohio.
Devos, F. W., and C. T. Reynolds Co., New York City.
Masury & Son, John W., New York and Chicago.
Moller & Schumann, Brooklyn, N. Y.
Murphy Varnish Co., Newark N. J.
Smith & Co., Edw., New York.
Valentine & Co., New York, Chicago, Boston, Paris.
Wiley Co., C. A., Hunter's Point, New York City.

Wheels.

Crane & MacMahon, New York.
Eureka Bending & Wheel Co., The, York, Pa.
Gifford & Son, John A., New York.
Hoopes Bro. & Darlington, West Chester, Pa.
Jones & Co., Phineas, Newark, N. J.
New Wapakoneta Wheel Co., Wapakoneta, Ohio.
Shortsville Wheel Co., Shortsville, N. Y.
Standard Wheel Co., Terre Haute, Ind.

Wheel Stock, Bent Wood, Etc.
Crane & MacMahon, New York.

White Lead.

Eagle White Lead Co., Cincinnati, Ohio.

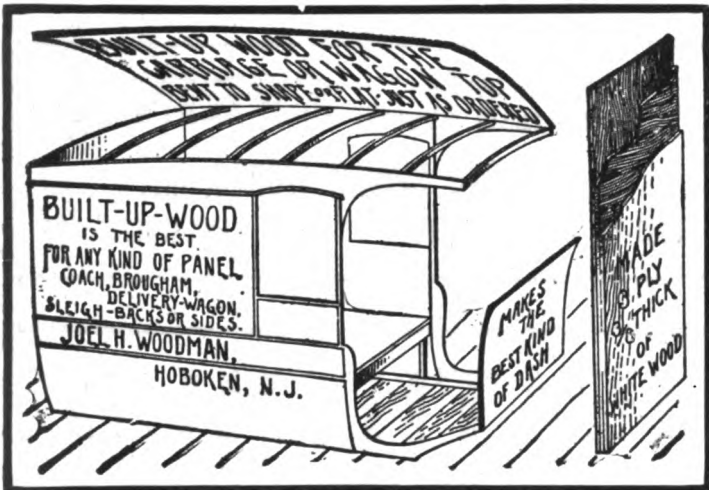

Goshen Eyelet Co.

Manufacturers of

**Carriage
Top
Trimmings**

GOSHEN, INDIANA

HEADQUARTERS FOR SPECIAL FINE GEAR IRONS [Drop Forged] CARRIAGE HARDWARE

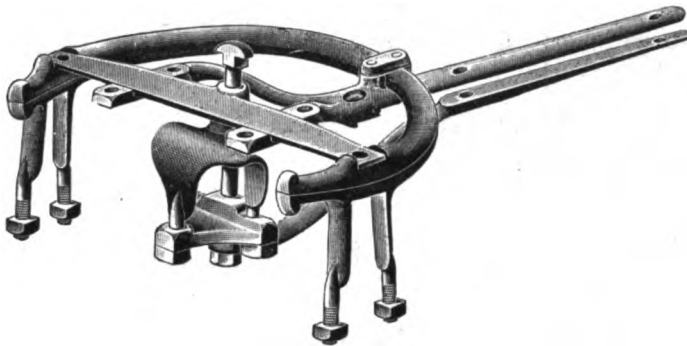

No. 1908—Gear Iron

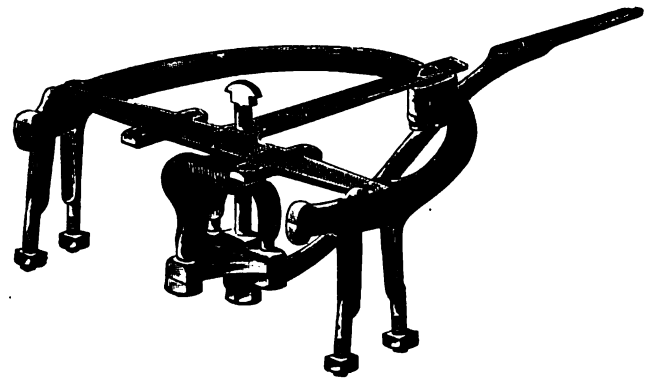

No. 2000—Gear Iron

WILCOX'S Mechanical 3 Prong King Bolt

Double Locked in Head Block Plate and King Bolt Yoke. No Strain on Bolt. No Turn on Nut. Guaranteed.

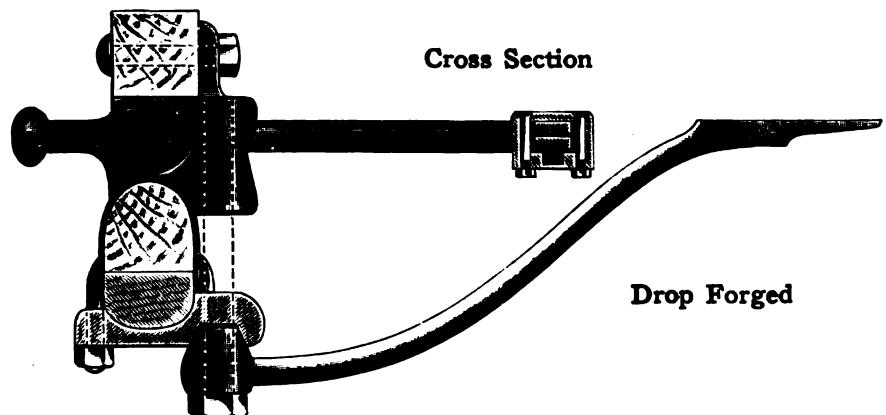

Cross Section

Drop Forged

Patented

SURE SAFE

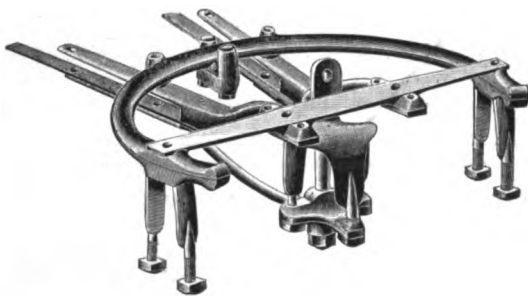

No. 1905—Gear Iron

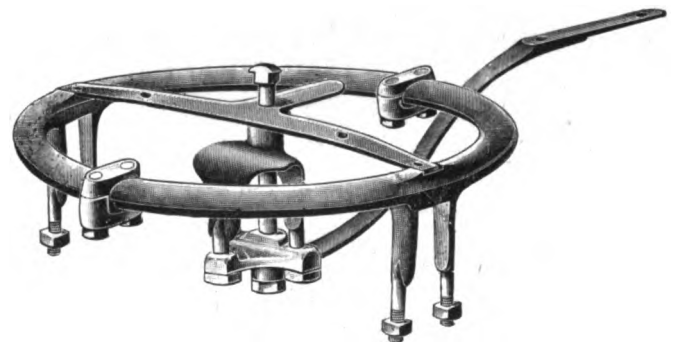

No. 1909—Concord

Forget your trouble and decide at once to use WILCOX DROP FORGED IRONS. Write us for pleasure

The D. Wilcox Mfg. Co. Mechanicsburg Pa.

Please mention "The Hub" when you write.

CARRIAGE FORGINGS

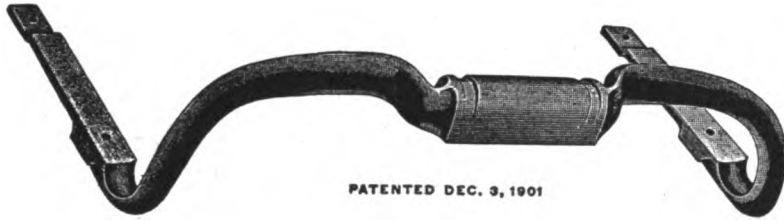

PATENTED DEC. 3, 1901

**The Standard Body Loop
None Like it. None Equal to it.**

A popular loop which is unequaled by any on the market.

We also make a full line of
CARRIAGE FORGINGS

THE KEYSTONE FORGING COMPANY
Northumberland, Penna.

FIFTH WHEELS

**The Well Known
SUPERIOR BRAND
OF
FIFTH WHEELS**

**Manufactured By Us Has No
Equal On The Market.**

Write us for Particulars and Prices.

Richard Eccles Co., Auburn N. Y.

Manufacturers of

Forgings: Carriage, Wagon, Automobile, Special
Send for Catalogue.



SAMUEL W. KILVINGTON

HAND-MADE

Automobile Bodies

LIMOUSINES, TOURING CARS AND RUNABOUTS DESIGNED TO
FIT ANY CHASSIS. HIGH GRADE WORK.

Estimates on Any Style Cheerfully Given.

THIRD AND WALNUT STREETS.

WILMINGTON, DEL.

Philadelphia Office: AUTO TOP AND BODY CO., 257-259 N. Broad St.

S. R. BAILEY & COMPANY, Inc.

Makers of the Celebrated.

WHALEBONE ROAD WAGON

AMESBURY, MASS.

VEHICLES AND GEARS IN THE WHITE



PREMIER
SIDE SPRING GEAR

We manufacture a full line of Carriage and Wagon bodies in the white; also Limousine, Taxicab, Touring Car and Roadster Bodies for automobiles in metal. Fifty styles of gears for Carriages and Wagons; also seats, trimmings and tops of all kinds.

Write to us for particulars.

Schubert Bros. Gear Company

ONEIDA, NEW YORK.

W. G. LEAS, Pres. and Treas.

J. L. BOWER Sec'y and Mgr.

Eureka Bending & Wheel Works

YORK, PA,

MANUFACTURERS OF

Second-Growth Hickory and Oak Bent Rims,
Gear Wood, Buggy Bows, Bob Run-
ners and Bent Stock.



Manufacturers and Dealers
in all kinds of

LUMBER

Please mention "The Hub" when you write.

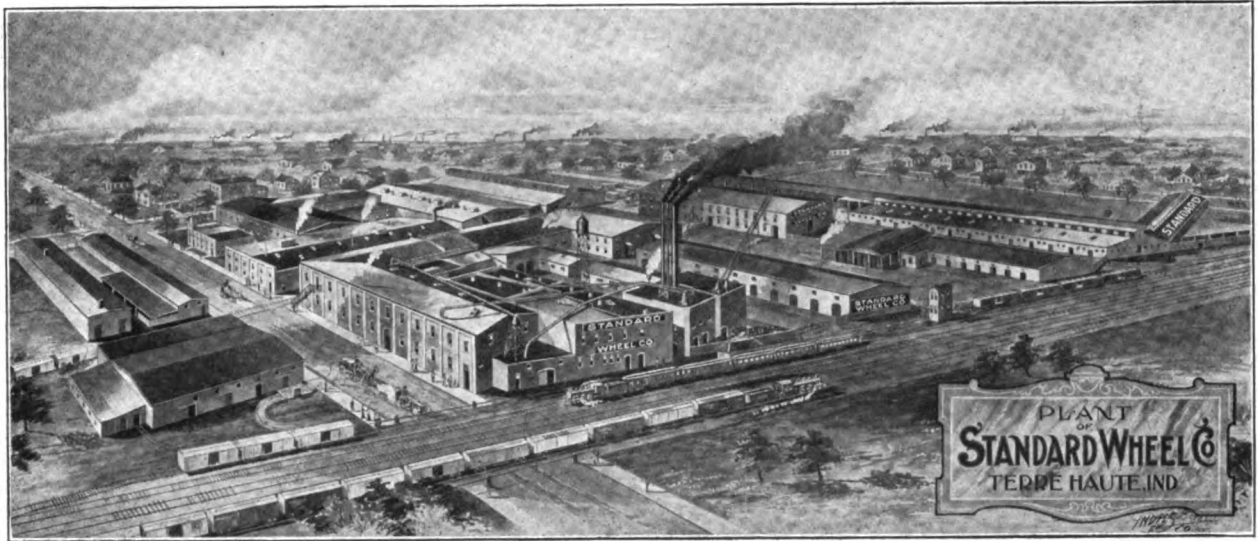

VEHICLE WHEELS AND WHEEL MATERIAL

Three Separate Departments [Light Carriage and Buggy Wheels
Heavy Express Wagon and Truck Wheels
Automobile Wheels

OUR GRADES ARE UNEXCELLED

WRITE FOR LIST.

Terre Haute, Ind. STANDARD WHEEL CO. Terre Haute, Ind

THE AJAX LINE

Includes all of the new forgings
for AUTO BUGGY SEATS

A Point to consider—

We can furnish all of your top
forgings from one factory, for
either automobile or buggy.

QUALITY AND SERVICE

CORTLAND FORGING CO.

CORTLAND, N. Y.

Carriage Mechanics

Desiring to improve their present
Condition should attend the

TECHNICAL SCHOOL

FOR

Carriage Draftsmen and Mechanics

SUPPORTED BY THE

Carriage Builders' National Ass'n.

The object of the School is to teach men to design
vehicles and make working drawings, and to otherwise
facilitate their work in the shop. Only those men employed
in carriage or automobile building or their accessory trades
are admitted to its privileges.

The classes are conducted in three divisions, viz.: Cor-
responding, Day, and Evening. The former is open during
the entire year, while the day and evening classes are in
session only from October 1st to April 1st.

The tuition is moderate.

For prospectus and full particulars, write to the instructor,

ANDREW F. JOHNSON,

18 West Forty-fourth St.,

NEW YORK CITY.



MERITAS
STANDARD
OTC
COMPANY
OIL CLOTH

Cover a carriage top with MERITAS enameled oil cloth—cover another with any other kind—follow them up and see how long the tops last.

MERITAS will be in good condition long after the other has been caked, cracked and weather-killed. Try it—then stick to the kind that lasts the longest.

Look on the back of the goods for our trademark.

See Your Jobber.

Standard Oil Cloth Co.
320 Broadway, New York

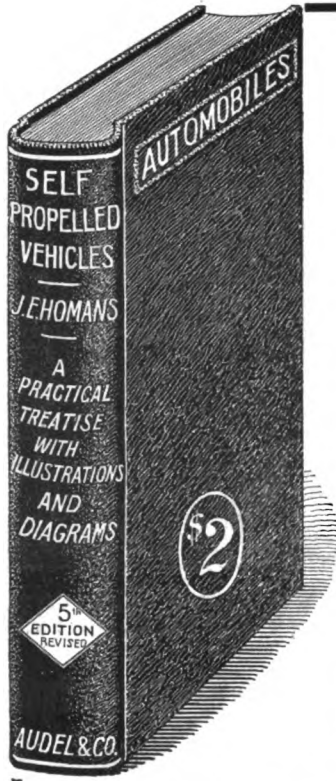

“Self-Propelled Vehicles”

Fifth Edition, Revised.

A practical treatise on the theory, construction, operation, care and management of all kinds of Automobiles.

By

JAMES E. HOMANS, A.M.

Contains 608 pages and upwards of 500 illustrations and diagrams, giving the essential details of construction and many important points on the successful operation of the various types of motor carriages driven by steam, gasoline and electricity.

This work is now the accepted standard, explaining the principles of construction and operation in a clear and helpful way. This book will be sent postpaid to any address in the United States, Mexico or Canada upon receipt of \$2.00.

Address

TRADE NEWS PUBLISHING COMPANY

24 Murray Street, New York

George J. Mercer

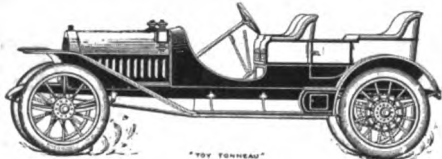

AUTOMOBILE BODY DESIGNER and DRAFTSMAN

Body Makers' Working Drafts, Color Designs and Scale Drawings of Pleasure and Commercial Automobile Bodies.

Room 401 1777 Broadway New York,

TRUCK BUILDERS

If you only realized the inestimable value of roller bearing fifth wheels on trucks, vans, delivery wagons and all other medium and heavy vehicles, no job would leave your shop without

Roller Bearing Fifth Wheels

WHY? The adjustment is perfect. No oil or grease required. Almost indestructible. Will outwear any vehicle. Saves horseflesh and prolongs life of vehicle. Ask your jobber for the celebrated

NIELSON OR KING

Let us send you Catalogue and Price List.

American Roller Bearing Fifth Wheel Co.
745 THIRD AVE., BROOKLYN, N. Y.



INDEPENDENT OF ALL COMBINATIONS

Eagle White Lead Co.

The Largest Lead Products Plant in the World.
CINCINNATI, OHIO.
CORRODERS BY THE OLD DUTCH PROCESS.

WHITE LEAD

THE ABOVE BRAND OF WHITE LEAD HAS BEEN ON THE MARKET FOR UPWARDS OF SEVENTY YEARS.

MINNEAPOLIS, Twin City Paint Co.
NEW YORK, 100 William St.
PHILADELPHIA, 142 No 4th St.
CHICAGO, 415-17 North Peoria St.

BALTIMORE, 447 North St., G.O. Shivers, Mgr.
BUFFALO, Builders' Ex., A. S. Coltz, Mgr.
KANSAS CITY, 600 Victor Bldg., G.P. Moore, Agt
PITTSBURG, Pittsburg Paint Supply Co., Agts

NEW ORLEANS, John R. Todd & Bro., Agents.
ST. LOUIS, R, 405 A. Benolst Bldg.,
B. P. Tammyer, Mgr.
CLEVELAND, The Hale & Holmes Co., Agents.
BOSTON, 60 Broad St., E. W. Osborne, Mgr.

F. W. DEVOE & C. T. RAYNOLDS CO.

101 and 103 FULTON STREET, NEW YORK

Manufacturers of

F. W. DEVOE & CO'S {
COACH COLORS
VARNISHES
BRUSHES
SPECIALTIES

C. T. RAYNOLDS & CO'S {
COACH COLORS
VARNISHES
BRUSHES
SPECIALTIES

FOR PAINTERS, ARTISTS AND DECORATORS

All the brands and specialties of F. W. Devoe & Co. and C. T. Raynolds & Co. will be maintained separately as heretofore.

WIRE WHEELS TO FIT EMPIRE BALL BEARING AXLES

Quality Unsurpassed

Write Today

The Mott Wheel Works
UTICA, N. Y.

What is a Brake ?

Is it an article that stops your vehicle when needed, and the same time ruins your rubber tires, or is it something that rolls against the tires, protecting them, but not stopping the vehicle? No, these cannot be called brakes. A brake is an article that WILL STOP the vehicle, WITHOUT RUINING the tires.

Is there such an article on the market? Yes, the DAVIS FRICTION METAL ROLLER BRAKES are the only brakes on the market that embrace these qualities, along with many other qualities, beneficial to all rubber tire vehicles.

The DAVIS brakes can be immediately placed on any vehicle equipped with or for the old brakes, by simply removing the old shoes, blocks, or rollers, and squaring the ends to fit the DAVIS.

For prices and further information write to the
NATIONAL ALUMINUM & BRONZE CO.
SOLE MANUFACTURERS.
INDIANAPOLIS, INDIANA
Will exhibit at C.B.N.A., National Vehicle and Tri-State Shows.



BOLTS Rivets, Carriage Makers' Washers
and Burrs for all kinds of Vehicles
Russell, Burdsall & Ward Bolt and Nut Co.
Main Works, PORT CHESTER, N. Y. Branch at Rock Falls, Ill.

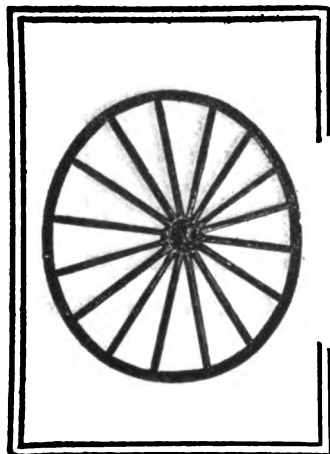

Time Has Told the Story!
Service and satisfaction always follow our rolling stock

WHEELS

ALL KINDS—BEST QUALITY

Also RIMS and SPOKES

The Eberly & Orris Mfg. Co.
MECHANICSBURG, PA.

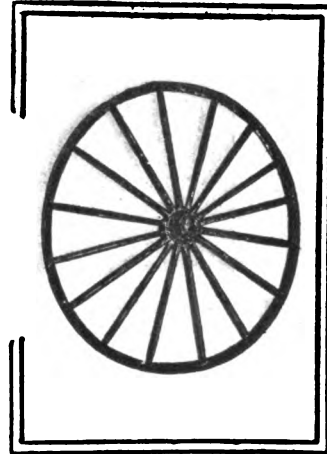

McKINNON DASH COMPANY

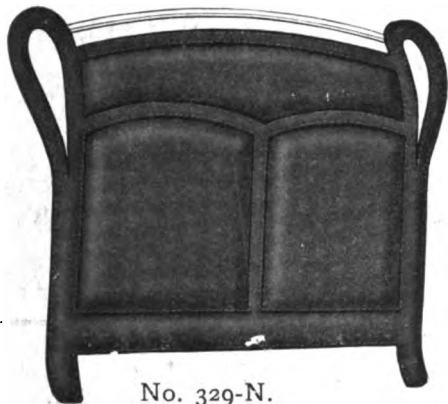

No. 329-N.

BUFFALO, N. Y.

TROY, OHIO,
CINCINNATI, OHIO.

ST. CATHARINES,
ONTARIO.

Our No. 329 N, with nickel rail
is one of our new designs
for 1911
The rail insures the life of the dash

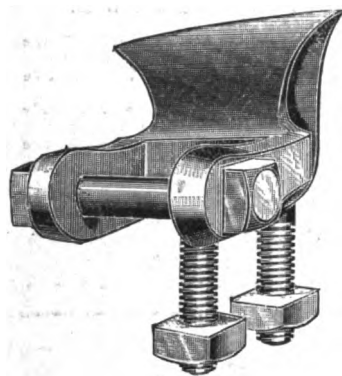

Skewed Shaft Couplings

**Regular or Oval Patterns
For High Arched Axles**

Furnished in rights and lefts for any height of arch. Oval Axle
Clips $\frac{5}{8}$ or $\frac{3}{4}$ width to match Oval Couplings. Bolts, Clips,
Couplings, Carriage Hardware and Special Forgings

Catalogue "H" and Prices on Application.

COLUMBUS BOLT WORKS, Columbus, O.

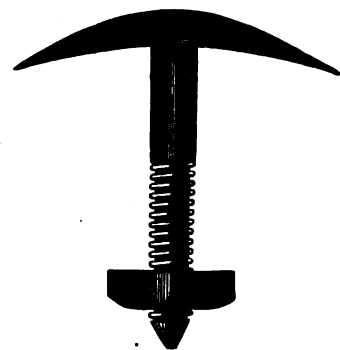

VEHICLE WHEELS OF REAL WORTH

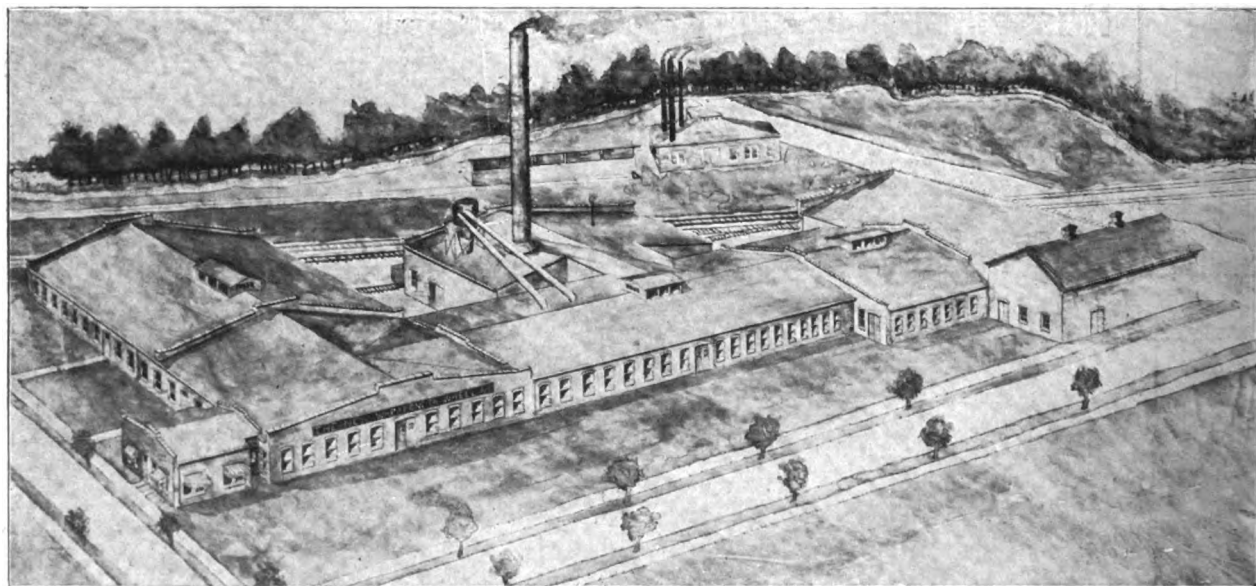

We manufacture Vehicle Wheels of All Kinds; Light and Heavy. Sarven, Warner, Compressed Band
and Wood Hub. Send for our Price List.

THE NEW WAPAKONETA WHEEL COMPANY
WAPAKONETA, OHIO

The Hub



**AUTOMOBILES
CARRIAGES
MOTOR TRUCKS
WAGONS**



TRADE NEWS PUBLISHING CO
24-26 MURRAY ST., NEW YORK

Hoopes Bro. & Darlington Inc.

West Chester, Penna., U. S. A.

SARVEN
STAR or KENNY
Sweet Concealed Band
WOOD HUB
WARNER

WHEELS

HEAVY and LIGHT
for
CARRIAGES
WAGONS and
TRUCKS

IF YOU WANT THE BEST TRY OURS

The Output of Complete FRONT AND REAR AUTOMOBILE AXLES of this Plant Exceeds the Capacity of All Competition Combined.

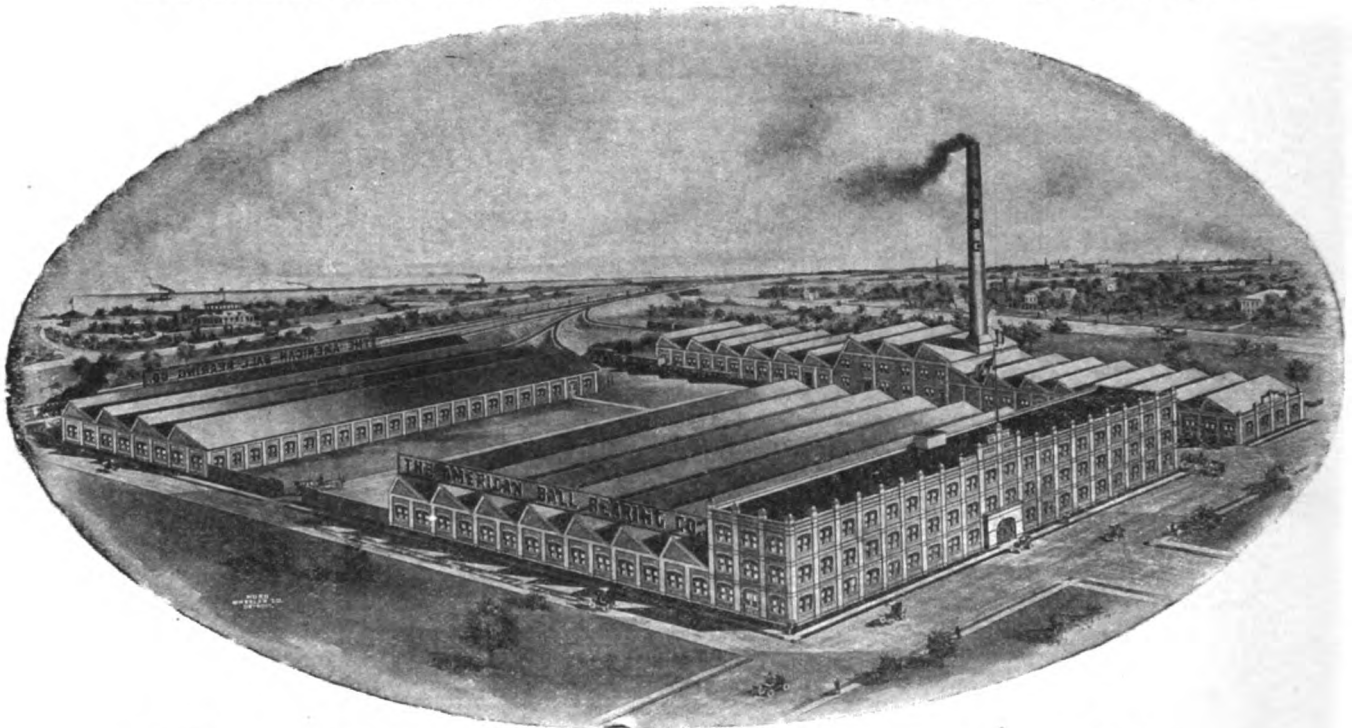

The American Ball-Bearing Co.,

L. S. & M. S. R'y and Edgewater Park.

CLEVELAND, OHIO, U. S. A.



CRANE & MACMAHON,

(INCORPORATED)

8-10 Bridge St., NEW YORK CITY, U. S. A.

Sole Manufacturers and Exporters of the

HICKORY NUT,  ACORN,  and STAR  BRANDS OF

Carriage, Wagon and Automobile Wood Stock

FACTORIES:

ST. MARYS, OHIO. RICHMOND, VA.

For Export Prices apply to the New York office.

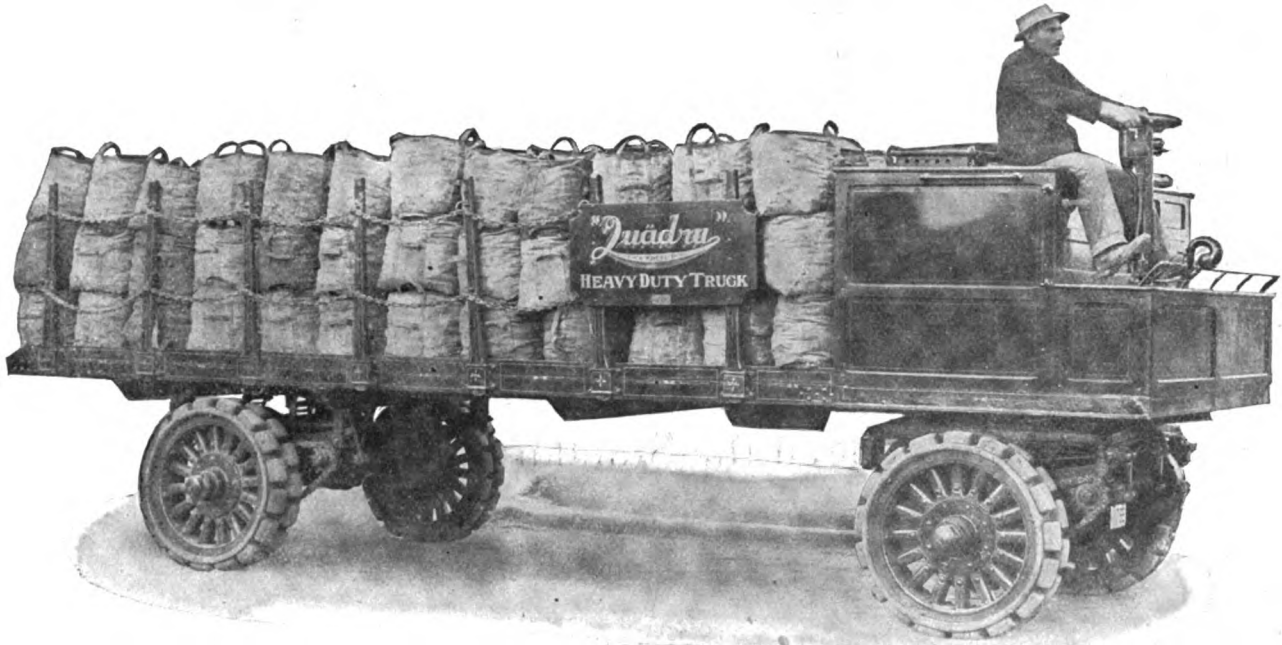

Load—Ten Tons of Coal.

SOLVED! Is the way motor car experts express themselves on the subject of tires for commercial motor vehicles after seeing and using the

KELLY-SPRINGFIELD SECTIONAL TIRE

With a grip on the road that means progress and security from the fault of solid tires—that of crowding the rubber ahead under load, which means disintegration—the motor wagon and truck owner will find in the Kelly-Springfield Sectional Tire the best tire for all heavy cars. Each section is dependent upon itself. If interested, write

CONSOLIDATED RUBBER TIRE COMPANY

New York, N. Y., and Akron, Ohio

Branches: Boston, Chicago, Philadelphia, St. Louis, Detroit, Cincinnati, San Francisco.

THE
A. T. A. NELSON CO.
Cincinnati, Ohio

Cut Leather

All Sizes, All Grades
Pole & Shaft Straps
Auto Straps

Vehicle Trimming Specialties

WRITE US QUICK

THE
A. T. A. NELSON CO.
Cincinnati, Ohio

JOHN REILLY Inc.

Established 1865

MANUFACTURERS OF ALL GRADES OF

LEATHER

FOR THE

Carriage & Automobile Trade

PARTICULAR ATTENTION CALLED TO

OUR AUTO SPECIAL

FACTORIES,

Avenues C & D, Murray & Astor Streets.
NEWARK, N. J.

AGENTS,

Cincinnati—National Hardware Co., Fourth Street
Detroit—C. W. Findlater, No. 313 Forest Ave., West

Please mention "The Hub" when you write.

JOHN W. MASURY & SON

Originators of

Superfine Coach and Automobile Colors

Acknowledged the Standard for Fifty Years

AND MANUFACTURERS OF

Fine Carriage and Automobile Varnishes

New York, Chicago, Minneapolis, Kansas City

Increase Your Sales ?



By having your Buggies equipped with **CATELY'S BUGGY TOP SPRINGS AND LEVERS.**

Pull on the inside levers and the top is lowered with ease. A gentle start and the top is up. Prevent broken bows and rattling joints. Best of talking points to interest trade and help sell your buggies. Manufacturers will put the springs and levers on your buggies when you so specify. Some manufacturers put springs and levers on some styles of their buggies as part of regular equipment. Yours for the asking. We also have trade winners in standard Third Seats, Camp Stools and Auto Chairs. The prices are low so write for catalog.

SELF ACTING SPRING

TOUGH THIS LEVER

CATELY & ETTLING, Cortland, N. Y.
[Members Carriage Builders' National Association.]

The WEST Hydraulic Tire Setter WILL CUT DOWN EXPENSE

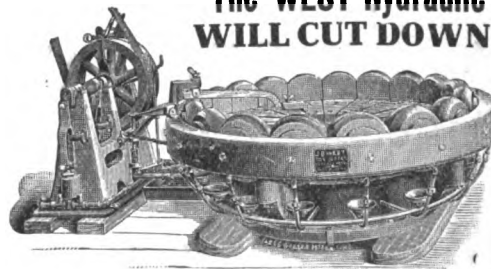

Tires set cold in one minute. This machine saves time — does the work better and quicker, does away with burned streaks. Only necessary to measure one wheel in a lot. Does not char the rim and thus make the tire loosen prematurely. Saves re-sandpapering of wheels.

This machine is now increasing the profits of many manufacturers. Send for catalog and read about it.

WEST TIRE SETTER CO., ROCHESTER, NEW YORK

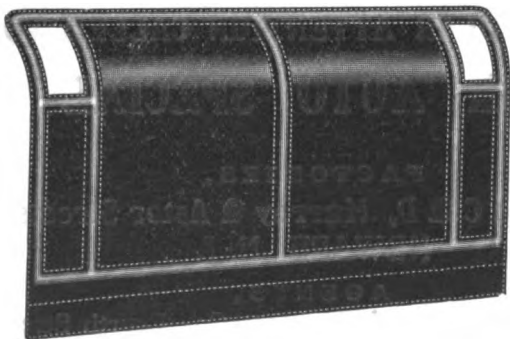

THE INDIANAPOLIS DASH COMPANY

Manufacturers of High-Grade

DASHES AND FENDERS

ALSO ROLL-UP-STRAPS

AND PROPS BLOCK WASHERS

INDIANAPOLIS,

INDIANA.

Please mention "The Hub" when you write.

THE AULT & WIBORG CO. VARNISH WORKS CINCINNATI, OHIO.

**SUPERIOR CARRIAGE
AND AUTOMOBILE VARNISHES**



The Quickest Thing in Quick Rubbing Varnish; Saves Time and Trouble
READY TO RUB IN 24 HOURS

**If You Have
VARNISH TROUBLES
Come to us.
We Have the Remedy.**

**Factory: Norwood, Ohio.
Branches:
New York, Philadelphia, Chicago,
St. Louis, Toronto, etc.**

**We will sell 100 of these
solid bent seats at cost.**



No. 68.

**A few other styles
for prompt delivery.**

**THE FRANTZ BODY MFG. CO.
AKRON, OHIO.**

METAL DASHES

**For Horse Drawn Vehicles.
Use Them on Your Output of Spring
Wagons Next Season.**

**They Are Cheaper and More
Durable Than Leather.**

**WRITE FOR CATALOG.
BENNETT MFG. CO. ALDEN, N. Y.**

**'GRAMM'
The World's Best
Why Should You
Buy a
"GRAMM?"**

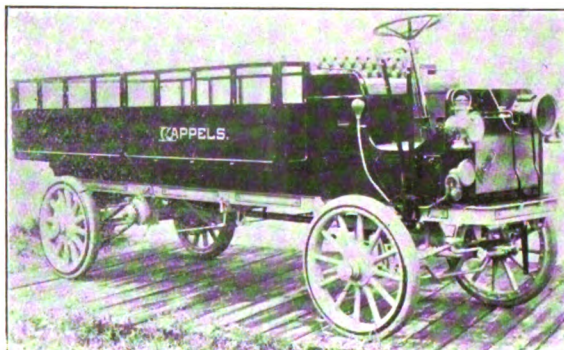

A Two-Ton Furniture Type Truck

Because—
IT'S THE "BEST"
Three-Point Motor Suspension
Clutch That's
Indestructible
Built Exclusively
in Our Own Plant

Factories—Lima, Ohio
Bowling Green, Ohio

THE GRAMM MOTOR CAR CO. Bowling Green, Ohio

Please mention "The Hub" when you write.

ELEVANTH NATIONAL

AUTOMOBILE SHOW

AT
MADISON SQUARE GARDEN
NEW YORK

Open for two weeks



PART I. January 7-14, 1911.
Gasoline Pleasure Vehicles, Parts and Accessory Manufacturers.

PART II. January 16-21, 1911.
Commercial Vehicles, Electric Pleasure Vehicles, Motorcycles, Parts and Accessory Manufacturers.



Under the Auspices of
ASSOCIATION OF LICENSED AUTOMOBILE MANUFACTURERS

Sanctioned by the National Association of Automobile Manufacturers and by the Motor and Accessory Manufacturers.

The Following Cars are Licensed under Selden Patent :

| | | | | | | | |
|----------|---------------------|-------------------|--------------|------------|---------------|----------------|-----------------|
| Acme | Cartercar | Elmore | Hewitt Truck | Lozier | Moline | Pierce-Arrow | Sampson Truck |
| Alco | Case | Everitt | Hotchkiss | McIntyre | Moon | Pope-Hartford | Selden |
| American | Chadwick | Ewing Taxicab | Hudson | Mack Truck | Morgan Truck | Premier | Simplex |
| Amplex | Chalmers | Flanders | Hupmobile | Marion | National | Pullman | Speedwell |
| Apperson | Columbia | Franklin | Inter-State | Marmon | Oakland | Rainier | Stearns |
| Atlas | Corbin | Fuller | Jackson | Matheson | Ohio | Randolph Truck | Stevens-Duryea |
| Autocar | Courier | Garford | Kissel Kar | Maxwell | Oldsmobile | Rapid (Com'l) | Stoddard-Dayton |
| Brasier | Delaunay-Belleville | Glide | Knox | Mercedes | Overland | Regal | Studebaker |
| Brush | Dorris | Grabowsky (Com'l) | Lambert | Merced | Packard | Reliance Truck | Thomas |
| Buick | E-M-F | Great Smith | Lancia | Midland | Palmer-Singer | Reo | White |
| Cadillac | | Haynes | Locomobile | Mitchell | Peerless | Royal Tourist | Winton |

Management: SHOW COMMITTEE, A. L. A. M., 7 East 42nd Street, New York

WILLEY'S

COLORS

The **RECOGNIZED STANDARD**



C. A. WILLEY CO.

COLORS GRINDERS

and Manufacturers of Specialties in

CARRIAGE, AUTOMOBILE AND CAR

PAINTS

COLORS, VARNISHES, ETC.

HUNTER'S POINT, NEW YORK CITY

KIMBLE'S FAMOUS GEAR WOODS

still represent the highest standard of excellence and quality. True to our motto our line wins the approval of all vehicle builders.

WHAT CAN WE DO FOR YOU ?

ANDREW KIMBLE

ZANESVILLE, O.

KEYSTONE BLACK FILLER

MAKES A PERFECT

ROUGHSTUFF

For Automobile Bodies and Parts

It fills the pores of Metal and Wood perfectly. Sandpapers easily and produces a fine smooth surface that DOES NOT CRACK, SCALE NOR PEEL.

POMEROY & FISCHER, New York
Selling Agents to Vehicle Trade

KEYSTONE PAINT AND FILLER CO., Muncy, Pa.

Please mention "The Hub" when you write.

For You The Carriage Dealer

The article that follows is taken from the July number of "Judicious Advertising." It describes very appreciatively what the B. F. Goodrich Company is doing for the Carriage Dealer. If this sort of original and direct advertising appeals to you, the B. F. Goodrich Company welcomes an opportunity to help you present the decided merits of Goodrich Solid Rubber Carriage Tires to the Carriage Owners of your community.

Framing the Dealers' Campaign

"THE business of getting close to the dealer, one phase of which was exploited in the June number of 'Judicious Advertising,' is shown in this campaign in concrete form. The campaign was first worked out with the firm of Harrah & Stewart Company, Des Moines, Iowa, one of the large number of Goodrich dealers. It consisted merely of follow-up matter to the carriage owners of Des Moines, the idea be-



"In
Des Moines
Prosperity
is a
Habit."
—Wealth

ing to hammer home the thoughts in the dealers' advertising locally. The work of the Goodrich Company for its dealers exemplifies a basic business principle that is of tremendous importance to manufacturers all over the country.

"For the Des Moines dealers, the advertising department undertook the planning of an advertising campaign which would present the advantages of their service and of the Goodrich product. To the carriage owners of Des Moines one of these leaflets will be sent out each month.

"It was sought to make the advertising very local—something that would appeal to every loyal citizen in Des Moines. Therefore, 'The Des Moines Idea'—that is to say the keen public spirit of Des Moines people—suggested itself as a motive.

"A great deal of care was taken with the drawing on the leaflet, to reproduce those scenes which would interest the citizen and which would

beget attention. The phrases from 'Wealth,' the publication issued by the Greater Des Moines Committee, and featured in its national advertising campaign, were the cue for the talk which followed on the inside of the leaflet. No suggestion was given in the outside as to what was contained within, yet care was taken to make the connection between the two logical and clear. In other words, this experiment was undertaken with the idea of putting the advertising matter of one firm in the community on a higher plane than is customary—that is, to attach it to the broader interests, to the interests of the community as a whole, and thus to make it social, and give it, so to speak, an ethical quality.

"It identifies the interest of the individual buyer looking out for himself, with the broader interest of the whole body of buyers—that is, with the City of Des Moines.

"The feat of taking advantage of the national advertising of the city of Des Moines, naturally,



"Life is
Worth
Living
in
Des Moines"
—Wealth

Kingman Boulevard.

was bound to attract tremendous interest in the leaflet to the Des Moines carriage owners, into whose hands the matter went.

"Such ideas promulgated for the benefit of the dealer are bound to cement the manufacturer's relation with him, and after all, that is the process which sells most goods. Such exhibition of good feeling for the dealer accomplishes results along lines of easiest resistance."

Tell Us What We Can Do For You. Address

THE B. F. GOODRICH COMPANY
AKRON, OHIO

A Twice Told Tale

VANADIUM VARNISHES COLOR-VARNISHES

They prove themselves even in the hands of the
careless

Trade **VALENTINE** Mark
VARNISHES

SAMPLE COLOR CARD ON REQUEST

VALENTINE & COMPANY

New York Chicago Boston Toronto Paris Amsterdam

83 Years' Experience in Every Can

E.S.
1827
& CO.

Edward Smith & Co.

CARRIAGE VARNISHES

Everything from the
Bare Wood to the Finishing Coat.

CHICAGO

NEW YORK

Jones Wheels
BEST ON EARTH

KANTSAMORE

Phineas Jones & Co.

Newark, N. J.

RUB ————— RUB ————— RUB

THAT'S THE EXPERIENCE SOME PAINTERS HAVE WITH A POOR RUBBING VARNISH.
THEY RUB TILL THEIR HEART ACHES ONLY TO HAVE THE VARNISH SWEAT, OR ROLL
UP UNDER THE PAD

XX Diamond Rubbing and Hard and Quick Drying Rubbing "A"

DRY HARD TO RUB IN TWO DAYS, WITHOUT SWEATING, ARE TOUGH AND THE BEST
FOUNDATION FOR FINISHING COATS.

MADE BY **MOLLER & SCHUMANN CO.**

MARCY AND FLUSHING AVES.,

BROOKLYN, N. Y.

Please mention "The Hub" when you write.

THE TRADE NEWS PUBLISHING CO. OF N. Y. Publishers of THE HUB

J. H. WRIGHT, *President.* G. A. TANNER, *Secretary and Treasurer.*
24-26 MURRAY STREET, NEW YORK.

Other Publications of Trade News Publishing Co.:

HARNESS (monthly)per year, \$1.00
AMERICAN HARNESS AND SADDLERY
DIRECTORY (annual)per copy, \$4.00

THE HUB is published monthly in the interest of employers and workmen connected with the manufacture of Carriages, Wagons, Sleighs, Automobiles and the Accessory trades, and also in the interest of Dealers.

Subscription price for the United States, Mexico, Cuba, Porto Rico, Guam the Philippines, and the Hawaiian Islands, \$2.00, Canada, \$2.50, payable strictly in advance. Single copies, 25 cents. Remittances at risk of subscriber, unless by registered letter, or by draft, check, express or post-office order, payable to the order of TRADE NEWS PUBLISHING Co.

For advertising rates, apply to the Publishers. Advertisements must be acceptable in every respect. Copy for new advertisements must be received by the 25th of the preceding month, and requests to alter or discontinue advertisements must be received before the 15th day of the preceding month to insure attention in the following number. All communications must be accompanied by the full name and address of writer.

FOREIGN REPRESENTATIVES:

FRANCE.—L. Dupont, publisher of *Le Guide des Carrossiers*, 78 Rue Boissiere, Paris. Subscription price, 15 francs, postpaid.
GERMANY.—Gustave Miesen, Bohn a Rh. Subscription price, 12 marks, postpaid.
ENGLAND.—Thomas Mattison, "Floriana," Hillside Avenue, Bitterne Park, Southampton. Subscription price, 12 shillings, postpaid.

Style.

We believe it would supply curious reading if a consensus of opinion on What Is Style? could be had.

Many are competent to view and judge a finished product and say that is fine, or the opposite, but to explain why it is so might be harder for them than the pigs in clover puzzle. Yet many of these men are the very individuals on whom the task of creating style devolves.

Utility, we would say, ought to be the basis of beauty which is the best style.

If every single part of a vehicle is so designed as to make it the most suitable for its purpose, and if the parts are effectively combined, the result ought to be "style" because the result is best adapted for what it is intended.

If designers should keep this idea as a principle, if it can be so called, in view, there would never be an unstylish vehicle. The idea to be expressed in wood and metal may not be conventional at all, but if it can justify its existence it is stylish, even though strange in appearance at first because unconventional.

The flush-side auto body might be illustrated in this connection. At first it was not pleasant to most of us because it was against established notions. It seems, however, there are good utilitarian reasons for such practice in

auto body building, so we must readjust our outlook if it shall be found that the utility side of the argument is truly based. It will then begin to look quite as it should and become "stylish," simply because there are good reasons and justifications behind the at first strange appearing construction.

The so-called auto seat that is becoming so frequent a practice in buggy building has the comfort of the passenger as its motive. If the passenger finds the idea meets the requirements of his use, the low seat of the heretofore may come to look "out of style." Utility will have supplied the style.

Novelty should be looked at on all sides and on top and bottom before passing judgment for or against.

The Torpedo Body.

The great use being made of the torpedo body for automobiles makes us curious to know how it originated, and why it should have come into such popularity so suddenly. This style originated with the house of Rothschild, the great Paris coachbuilders. The idea from which this style was the emanation was the impulse to build a body for speed purposes only. There was no effort to conserve style, beauty or elegance of design. It was simply something built for high speeds, that should at the same time make the passenger as comfortable as possible.

The first of the type was designed by Rothschild in 1907. But the French automobilist did not take to the style. It fell flat, much to the disgust of the designers.

Finally the English, who are practical, but with few original ideas of beauty of design in coach building, saw the style in one of the shows, and it looked good to them.

The English at once built metal bodies of the kind, only they were even more exaggerated than the primary model.

The name torpedo was of English derivation, as the body looked like its name.

The next step was a recrossing of the Channel to its original French home, and it grew into a sort of popularity because it was supposed to be English. There are those in France who are attracted to almost everything English, as there are those opposed to the same.

The torpedo has never had the success in France that it has achieved in England and America.

If the day should come when the speed mania abates it would make a discernable difference in the styles in greatest demand at present.

We look for no original initiative in this country until the coachbuilder really dominates the trade of auto body building. At the present time most of the carriage body

builders who are constructing bodies for automobile factories, confine themselves to producing what their customers seem to desire, and the customer generally desires what he has seen some other one of his kind introduce, hence a dead level of lack of originality that could be expected from a machine shop.

The few who overstep such bounds, whom we point to as leaders, like Packard, Peerless, etc., are also imitators, finding their inspiration in the French fashion plates.

Painting.

There has been observed quite an amount of freakishness in motor body painting where there has been a departure from staid, conservative body color. When the painter lets his fancy run he produces so very glaring contrasts in combination. Nothing is a surer test of taste than the painting of the body, and as taste is a rare quality among men, it is natural to find the extraordinary when the painter gets off the beaten path.

The striping is more especially inharmonious. It is only when the master carriage maker takes the subject in hand that we find the canons of taste observed. It seems safest to adhere to the dark greens, blues, lakes, etc., to be sure of a satisfactory result.

The fine, generous colors need a heavy flow of varnish protection in automobile painting. Indeed, it has been found that the auto body is a hard proposition for the painter on account of the very careless handling it receives in garages.

How it Looks Abroad.

The advent of the motor car has modified conditions in England as elsewhere in the coach building trade. Our English contemporary comments on the state of affairs in a somewhat reminiscent strain. It thinks the old high-class, highly respectable concern did not see its opportunity as it should, and continued to look backward at the good old times. Others not so high-class, looking for opportunity, dabbled in auto body building, until a trade influence was created that has been provocative of good results all around.

The state of the horse vehicle trade in England, we would gather, is much less satisfactory than with us, yet the coach building trade is flourishing. It sums up like this:

"These happy attainments are the results of having taken up the motor car trade in the earlier days. There is still time for those who have not done so to commence, for there is room for all in the new industry, though it cannot be expected that their progress will be so rapid as with those who started in the race at the beginning. It is never, however, too late, and though advancement must necessarily be more slow than that of their more far-seeing competitors, the trade is still to be had if sought after.

"The boom in the motor car trade may be over for the present, but it has only settled down into a more regular and substantial trade, which will gradually permeate the whole country. There is, however, another boom coming, on which, if the coach-builders will take it up, should lead to equally good results. Ever since mechanical traction has been adapted to the common roads, it has claimed the attention of business houses for the delivery

of heavy goods and light parcels, but up to the present time the motor has been to a certain extent unreliable and more expensive than horse vehicles, therefore to a great degree the demand for motor vans was comparatively small, and they have only been used by firms who could afford the extra expense and put up with the inconvenience of unreliable delivery for the sake of benefits derived from the advertisements a motor van gave them. This, however, is no longer the case; the motor is now quite as reliable as the horse, and because of the extra distances it can cover is more economical. From the very beginning of the motor car industry it has always been our opinion, an opinion which we have expressed repeatedly in the columns of this journal, that until reliability and economy could be assured, the motor van would not be adopted as a commercial vehicle, whatever it might be as a private one. Both these have now been accomplished, and a boom in the van building is certainly imminent in the very near future; indeed, it might be said it has commenced. The van body is as much coachbuilder's work as the private car body, and it is for them to see that they get their full share. If any doubt as to the reliability of the motor still remains in the minds of our readers, this doubt would be easily dispelled by a visit to London, where thousands of taxi-cabs, omnibuses, vans and private cars are running about the streets and never a breakdown to be seen."

The Part of the Carriage in History.

A very interesting work is being done in France by the Society of the History of Costume and Coaches (Societe de l'Histore de Costume et de la Carrosserie). The aim of the collectors of objects is to put into museum shape examples of the centuries in progressive order, so that the artisan may study them and by this means enrich his professional education.

The museum is already established in Paris, and illustrations of its contents are already finding their way into the pages of technical journals, thus broadcasting the work of the society.

The French are admirable in such matters, so thorough in what they undertake and so practical in putting the accumulated information to the best use. They more than justify themselves as leaders in the higher elements of industrial progress.

The Franc is always aspiring to the beauty and art aspects, with the acquisition of another franc secondary in purpose.

The Kreutzer is ready to sieze the idea of beauty and to scientifically make it possible to sell it to the rest of the world, so that more Kreutzers will grow in the Fatherland.

The Dollar merely chases another dollar, and "blows" it for a good time.

Good Idea in Trimming Material.

We have seen some very nice samples of foreign made cloth for trimming that seems to be novel in one sense, that is, the laces and trimming material are made to exactly match the cloth. The laces are designed to suit the character of the textile, also. This is very artistic on the part of cloth makers, and will be appreciated by trimmers who are trying for best efforts.

It is a law that the more advanced the thought, the more certain it is that men will misconceive, despise and reject it.

Vehicle Fashions for December 1910

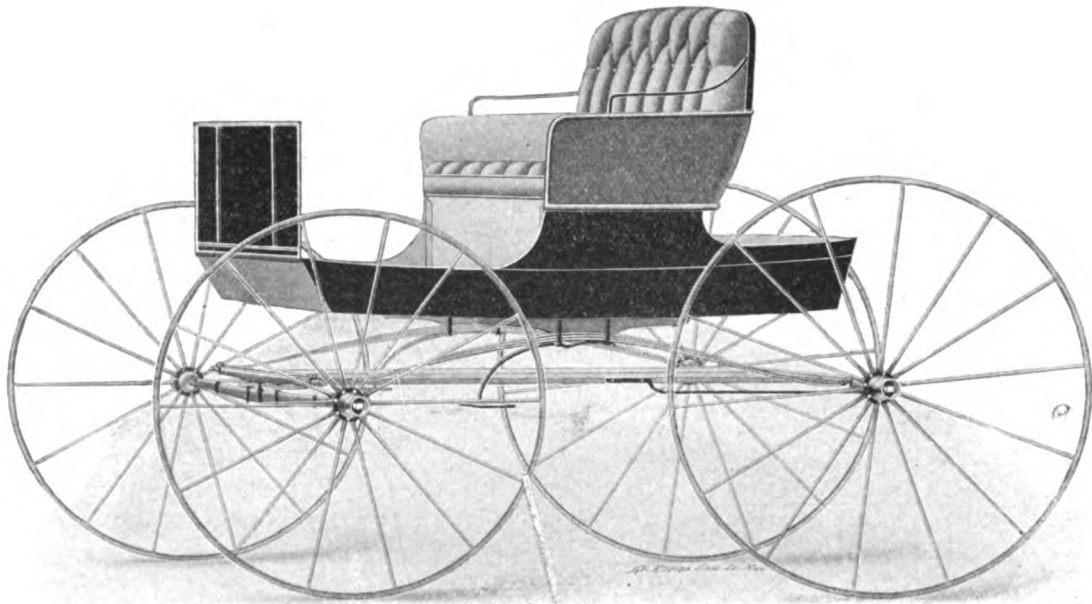

CONCORD BUGGY.
Made by D. M. Sechler Carriage Co.
(Described on Page 260.)

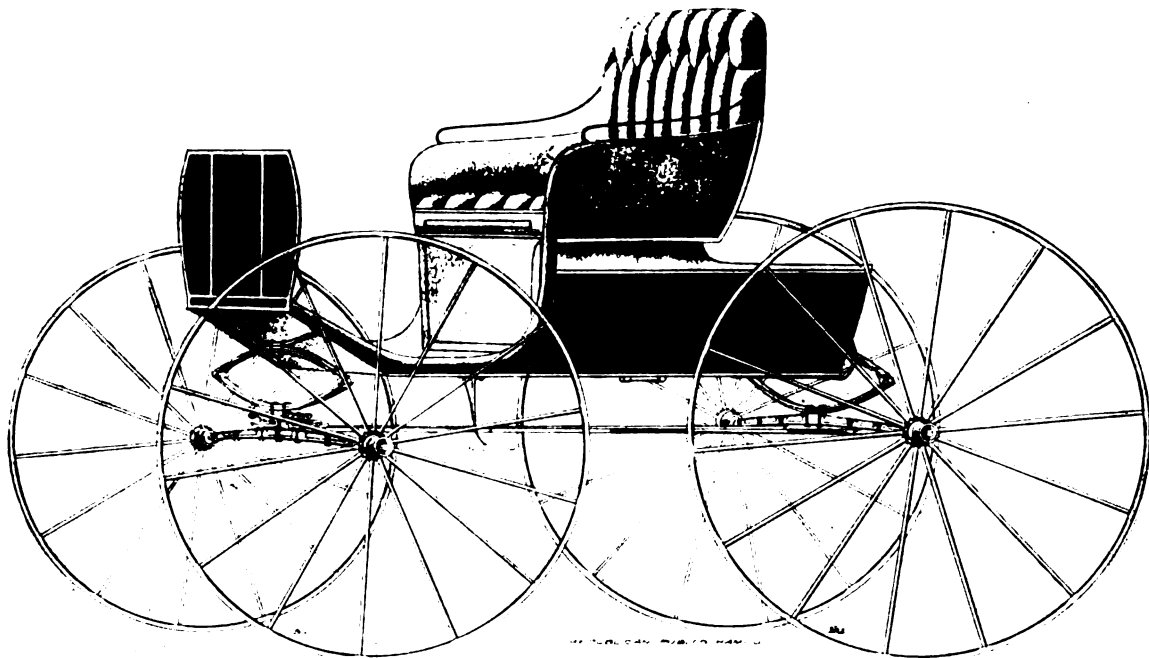

STANHOPE BODY BUGGY.
Made by D. M. Sechler Carriage Co.
(Described on Page 260.)

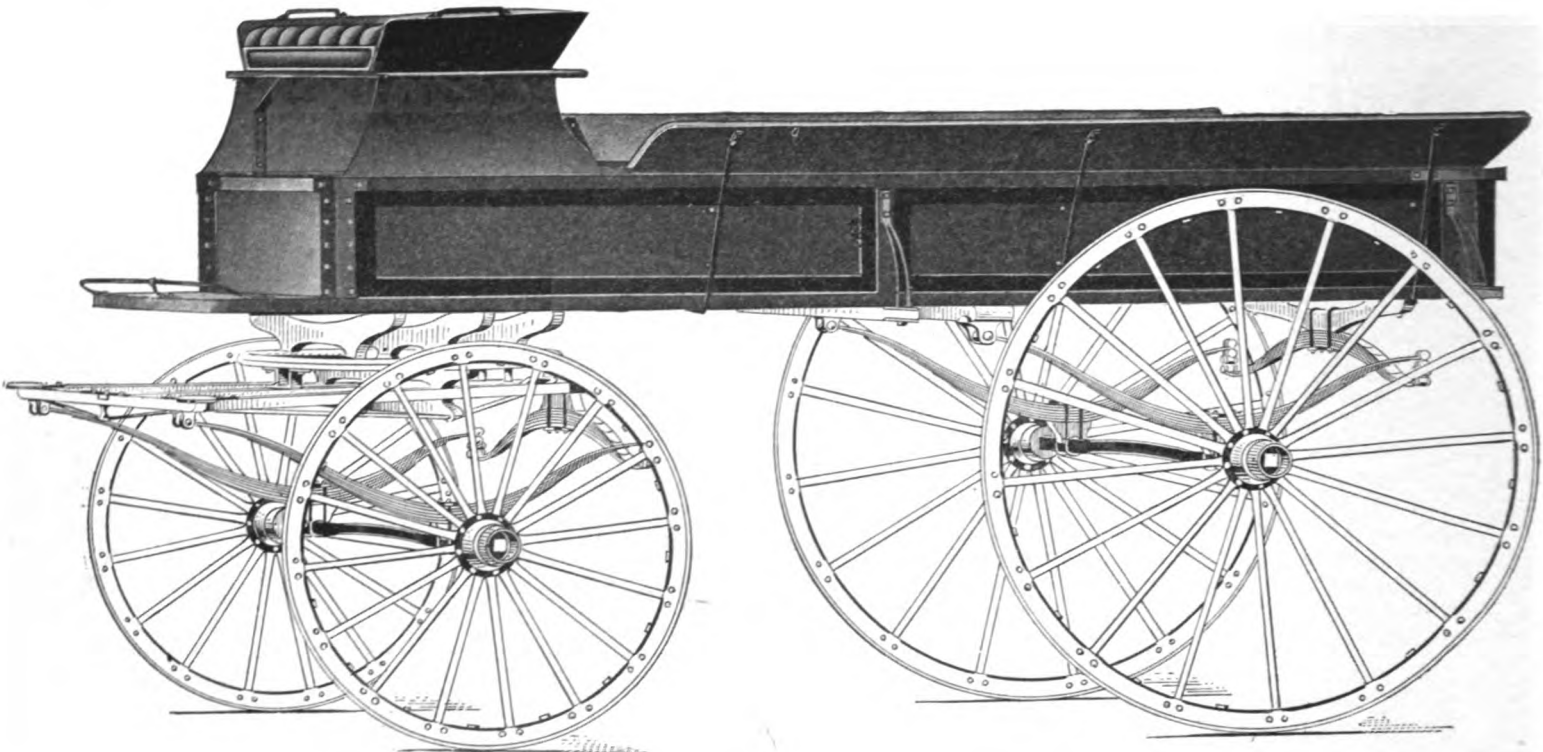

FULL PLATFORM CUT-UNDER DELIVERY WAGON.
Made by Parry Mfg. Co.
(Described on Page 260.)

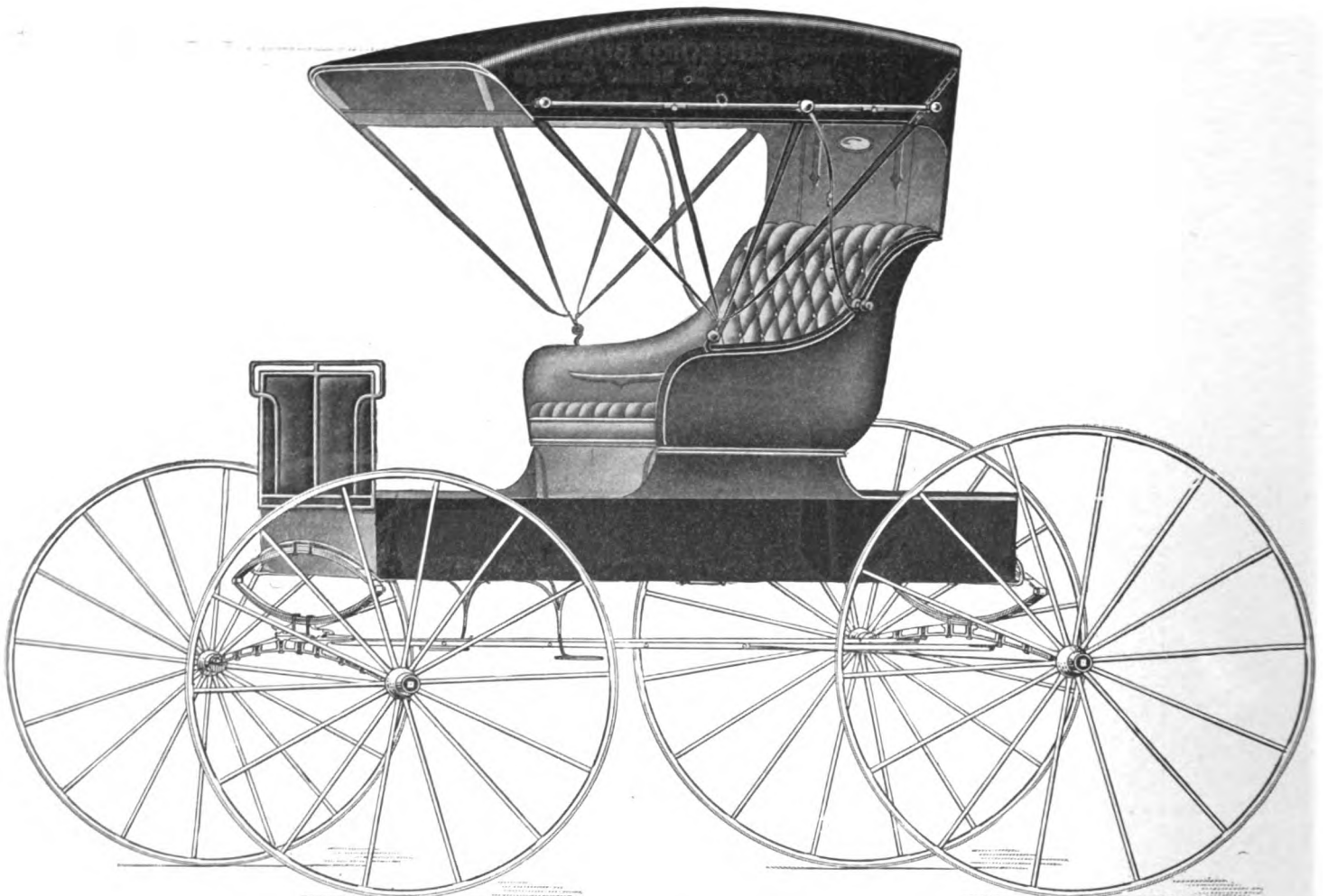

TWIN AUTO SEAT BUGGY.
Made by Parry Mfg. Co.
(Described on Page 260.)

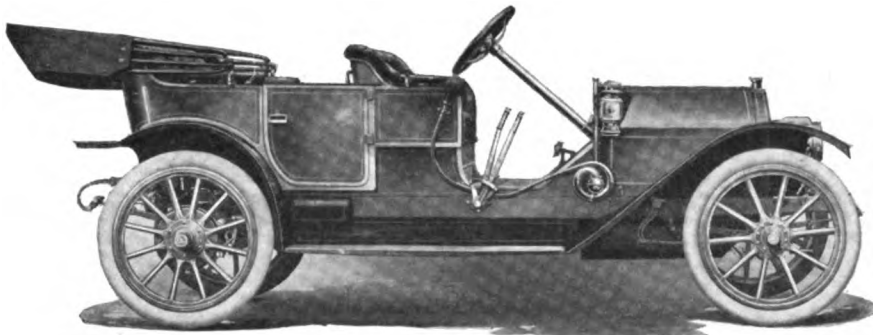

THE NEW HUDSON "33" CAR.
Made by Hudson Motor Car Co.
(Described on Page 260.)

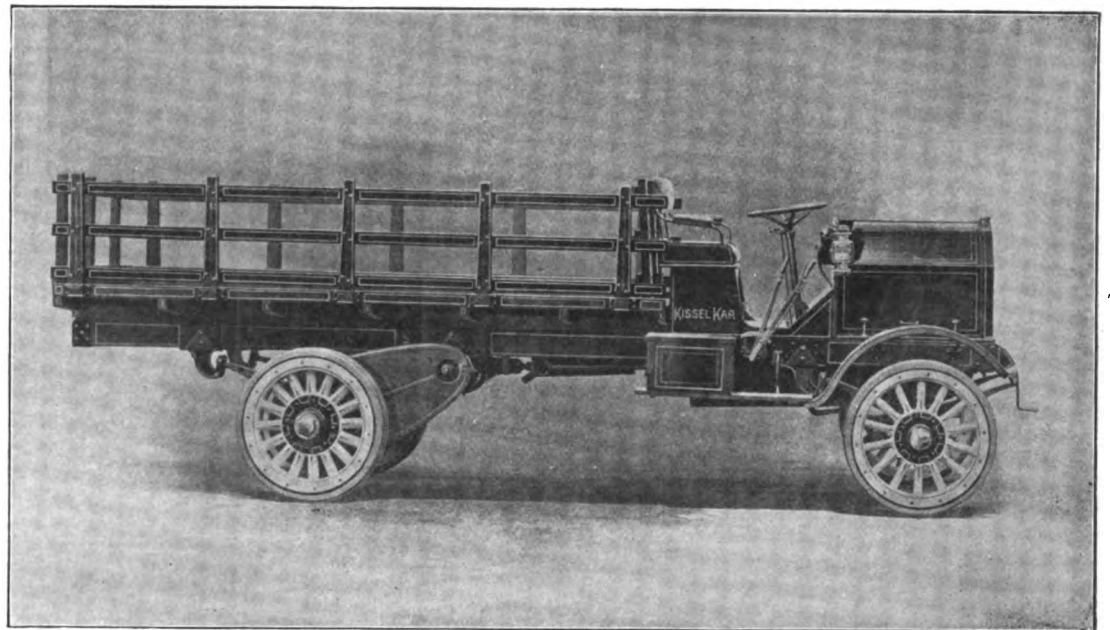

KISSEL HEAVY TRUCK.
Made by Kissel Motor Car Co.
(Described on Page 260.)

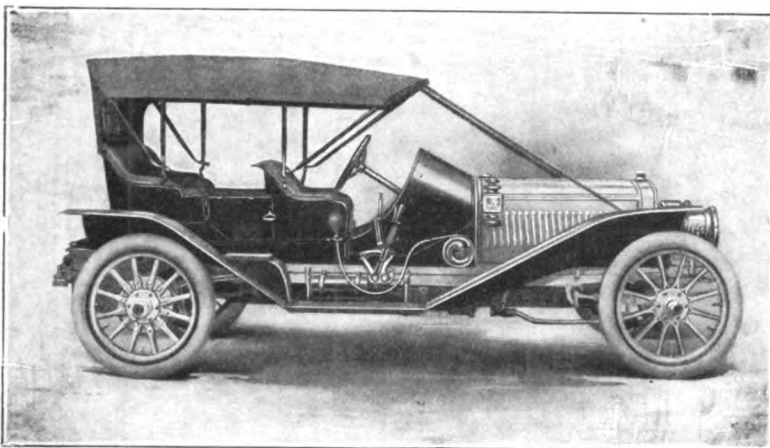

NEW MODEL LOZIER.
Made by Lozier Motor Co.
(Described on Page 260.)

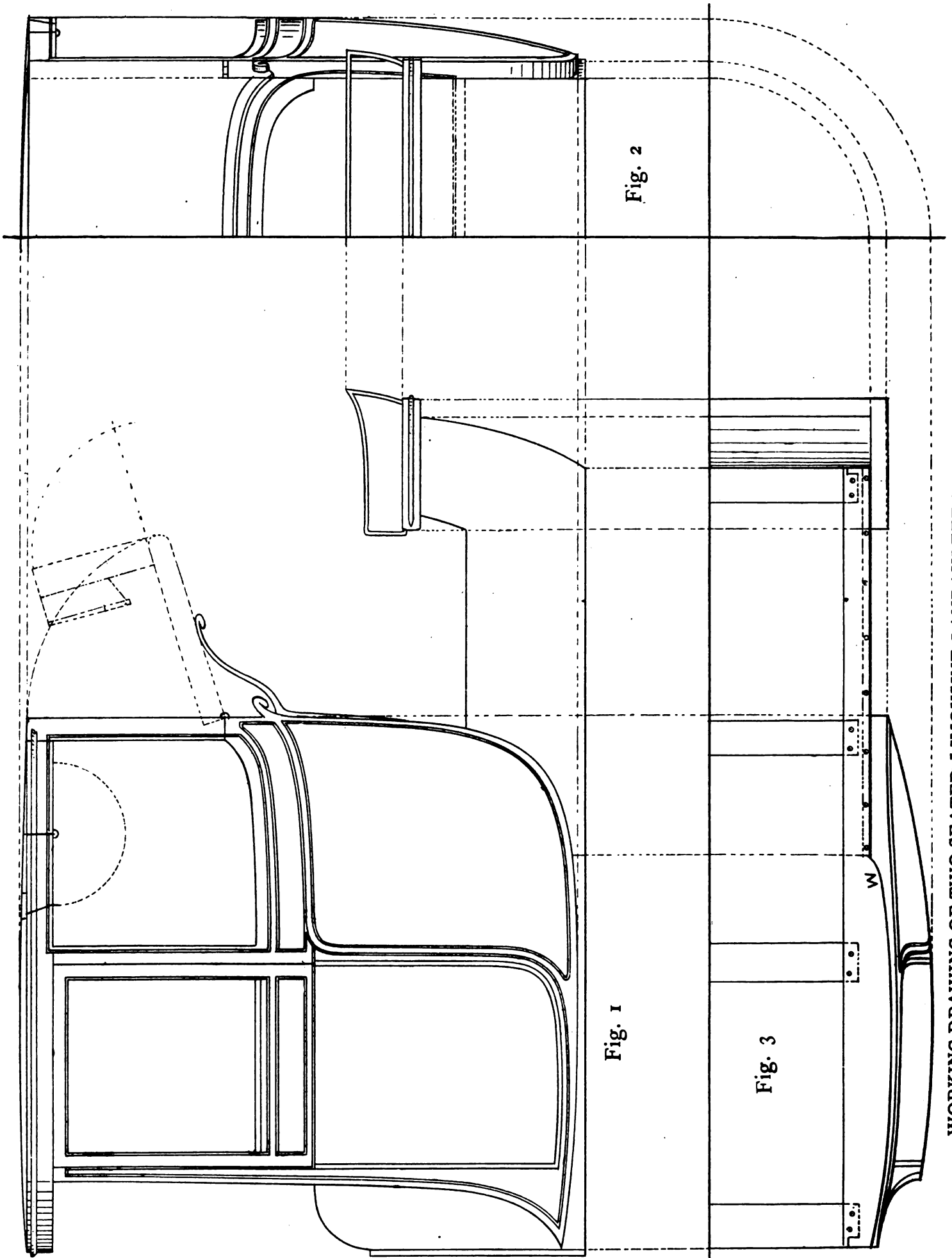

Fig. 2

Fig. 1

Fig. 3

(Described on Opposite Page.)

WORKING DRAWING OF TWO-SEATED LIMOUSINE LANDAULETTE.

Wood-working and Smithing

WORKING DRAFT OF TWO-SEATED LIMOUSINE LANDAULETTE.

(Drawing on Opposite Page.)

The two seated limousine landaulette motor body stands in a relative position to the single Brougham or coupe or horse traction. They are both very exclusive carriages, and high class vehicles catering to the tastes of those moving in the first ranks of society.

The body provides seating for two, and is therefore, what can be more aptly termed as self-chauffeur. An emergency rest can be fitted to the rear inside front, and as close up to the steering gear as is convenient. The car can thus be made to carry three inside without any discomfort, if desired, while the rumble boot seat provides seating for two, so that the car can carry five comfortably, though it is ostensibly designed for two, and for self-chauffeur. The addition of the rumble provides for a longer base of chassis than is obtainable in the body itself only.

With motorists who enjoy chauffeur themselves and desire the quietude obtainable in this design of single car, the working draft herewith will appeal very strongly, because of its aristocratic bearing and exclusive outline.

The coupling on the points of suspension is shorter than in those cars which carry back and front seating. But for all the purposes of motoring at a speed within the realms of safety, a car coupled to balance the weight to be carried is all that is necessary.

The lines of the body show a combination of the coupe and deep quartered victoria, which make a pleasing design. The body has all the solidity of the limousine, and the openness of the landaulette. The head is fitted in its opening on the principle of a side-light landaulette head. The top quarter corner pillar is hinged to the body pillar with a double flapped foot hinge, which is let into the joint end grain of the pillars, and up their back as well, and dressed off level. A hinge of this design makes a strong job of the opening. To support the pillar when the head is down, a stay is fixed to the body and curved to make a bearing for the head flap to rest upon. The fitting of the head in its folding parts and flaps, is as is usual in landaulette head fitting which is explained in the working draft herewith, and has also been often fully explained in working drafts, and in individual articles on head fitting in back issues of The Hub.

But it may be necessary to speak a few words about the hinging of the head, or rather on the hinges themselves. The hinge working the first flap is made especially for the work. The center pin stands below the line of the flap when the head is up. The feet of the hinge are cranked up and let into the flap above the line of the pillar flap hinge feet, the cross slats holding the flaps to position. These flaps are panelled over, the panels being boxed into the top of the slat's level, and covered with leather and painted in the same way as the front of the roof, while the back of the body from the elbow point where the folding pillar falls away up to the back slat is of enamel leather, which allows the folding of the head, a free fall when down in position on the head stay.

The glass from the quarter is made to drop down into the body quarter when the head is open, which is an adaptation from the earlier method of building side light landaus. We thus continually have practical every-day evidence that there is nothing lost in the matter which only changes form. Invention partakes almost of the same law, because old ideas strike new ground and return after years like "bread cast upon the waters," for truly "there is nothing new under the sun."

The body is framed with solid bottomsides, to which the front and standing pillars are framed. The standing pillar is got out wide enough to form the glass frame line of the top quarter, and also to allow the moulding formation of the curved standing pillar line of the quarter down to the bottomside.

The elbow and waist belt are in one, the elbow and panel moulding being boxed out in the solid, while the quarter panel is gigger-grooved into the solid moulding worked on the standing pillar, corner pillar and bottomside.

The body bottomsides are got out of sufficient depth to make the door line formation, and of sufficient width to work the turnunder sweep up on and to be cut back and half check framed to the solid sides of the rumble, as shown in the plan. This is necessary so that the solid side can line and be screwed to the side of the corner pillar and keep the inside of the bottomside in on unbroken line, which is shown in the plan.

A marginal panel space is shown from the quarter moulding to the door, right round to the coupe pillar, which throws the body moulding up from the panelling in fine relief. The lapping plate of the door shows more clearly the width of the spacing from the moulding to the door line.

Fig. 1. shows the full design and the working of the half head

Fig. 2 shows the half back view of body from which all the cross measurements can be taken, and the position of rumble and line of head pillar joint, together with the design of moulding and panelling in body and top cross rail, the width and projection of rumble seat over side.

Fig. 3 shows the plan of body upon which the lines of the body construction are correctly drawn; the base line, brackets off the width across body at back on elbow line, and across the coupe pillars; the position of turnunder line and its points of travel from the elbow point down to the extreme point of the bottom of the coupe pillar. This is a very important line in practical body making, whether in a motor car body as is being dealt with here, or in the more intricate horse-drawn carriage bodies of quick turnunder, and of various points of turnunder from the elbow line to the extreme depth of body. It is in the delineation of those points on the plan of a body where scientific body making is shown, and the absence of them, where the rule of thumb or "practical man," as he calls himself, is so clearly shown up by his cloudy methods of "rounding in" which is only another name for working in the dark.

The widths of the bottomside at any point can be measured off, and how the solid side of the rumble boot is let back on the bottomside to line with the corner pillars is explained; also the boxed back part of the bottomside at bottom; to form a light rocker, and to throw up the solid moulding of the body from it. It also shows how the rocker part of the bottomside is rounded into the solid side of the boot, at the joint fixing W.

The chassis should follow the width of the body on the rumble and be curved outward to follow the wider part of the body on its widest part, and thus take the weight more equally, and reduce the projectional leverage of the body over the side of the body at the doorway. The line of the fall and folding flaps position are shown in dotted lines, and the position of the supporting stay to the head and body, the head hinges are made shoulder stops to prevent the flaps from falling past the horizontal line.

The sizes for building are: Length of body on chassis line, 7 ft. 4 in.; depth of ditto, 13½ in.; width of neck on seat, 11 in.; depth of side at this point, 18½ in.; width of seat, 15 in.; depth of rail in front, 5 in.; behind, 6 in.; length of seat, 41 in.; length of body quarter on elbow line over mouldings, 27 in.; width of moulding panel, 1 in.; full depth of quarter over mouldings, 31 in. Width of waist rail panel on elbow from top of moulding, 5½

in.; length of ditto to door line, 28 in.; full depth of top quarter on door line to top of cant rail line, 32½ in.; width of quarter, 28 in.; width between pillars for glass frame, 23½ in., depth of ditto on standing pillar line, 23 in., at back on elbow curve, 19½ in.; width of door 23½ in.; depth of waist rail, 7 in.; width of chariot pillar at top outer surface, 2¼ in., on bottom, 9 in.; projection of canopy from pillar 8 in.; width of pillar quarter at top, 7½ in.

Width of the back of body on elbow line, 10 in.; width across standing pillars, 50 in.; across front pillars, 48 in.; across bottom of rumble boot, 37 in.; width of chassis, 36½ in., and should be forged to conform to the line of the body from the turnunder line curve narrowed in front again. Width across bottom of body at centre of turnunder line, 43 in.; width of bottomside at this point, 6½ in.

GOODRICH CO. ESTABLISHES CHAIN OF DEPOTS.

The B. F. Goodrich Co., has established a chain of rubber tire depots throughout the country, in cities in which it does not already maintain branches. These depots will each be in charge of experts trained by the company, and will serve as convenient centers for the repair of tires and for the adjustment of claims under guarantees. Liberal stocks will be carried, thus eliminating the necessity of local dealers carrying large stocks. The carrying out of this plan has been a matter of study for almost a year, and the managers of the twenty-seven depots left Akron during the past month for their new positions. The new depots will not sell tires to consumers, but are being established solely to benefit the dealers in their respective localities. The opening of the depots was slated for December 1. It is estimated that over \$550,000 worth of stock has been distributed among these depots.

The location of the depots is in the following cities: Brooklyn, Albany, Syracuse and Rochester, New York; Newark, New Jersey; Portland, Maine; Providence, Rhode Island; Springfield Massachusetts; Baltimore, Maryland; Washington, D. C.; Richmond, Virginia; Toledo, Columbus and Dayton, Ohio; Saginaw and Grand Rapids, Michigan; Milwaukee, Wisconsin; Memphis, Tennessee; New Orleans, Louisiana; Jacksonville, Florida; Louisville, Kentucky; Des Moines, Iowa; Houston and San Antonio, Texas; Omaha, Nebraska; Salt Lake City, Utah; and Oklahoma City, Oklahoma.

The following young men have been placed in charge of the depots: C. S. Bower, C. A. Fassnacht, D. E. Wilcox, E. Strachle, T. C. Norris, B. A. Thurin, W. B. Aldefer, C. A. Breyler, K. K. Kantzer, D. B. Jarvis, E. E. Rhoads, W. A. Gardner, C. E. Lindquist, G. H. Wood, W. H. Garner, O. A. Evans, E. H. Schwan, F. A. Schumacher, B. F. Morris, W. S. Rutherford, L. Woodward, J. D. Hotchkiss, N. J. Murray, F. Little, R. Hassler, G. P. Colman, and J. M. Dempsey.

CAPITAL STOCK INCREASED.

Notice of an increase of \$400,000 in the capital stock of the Great Southern Automobile Company has been filed in Birmingham, Ala. The company now has an authorized capital of \$500,000, having been organized with \$100,000 capital stock. The notice was filed in the probate court by E. F. Enslin, president of the company. It is understood that improvements costing more than \$100,000 are to be made. It is also said that the working force of the company will be increased from 70 to 200. The increase in capital stock is part of the plan.

LARGEST FACTORY BUILDING IN AKRON.

The Goodyear Tire and Rubber Co., has under construction what will be the largest single factory building in Akron. Two other rubber companies are building additions which together will exceed the new Goodyear building in size, but this will be the largest single building here. The new building, to be devoted to the manufacture of automobile tires, will be 400x146 feet, and six stories high, of reinforced concrete.

SHOP NOTES.

In a vehicle making establishment it was necessary to make a solid joint with a steel tube of the pattern shown in Fig. 1. A metal plug was first driven into the opening so as to afford a means for stopping up the inner channel BW. Then a hole was drilled to the upper side of the steel tube large enough to admit

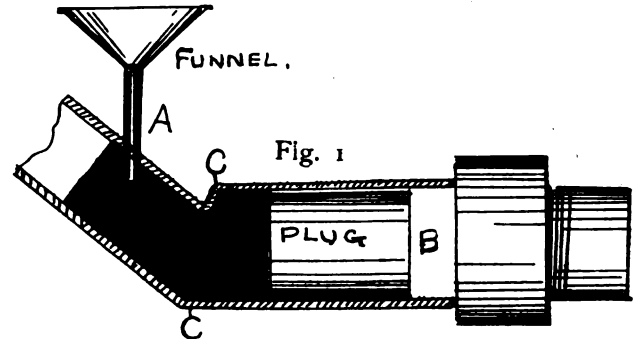

the terminal of a common funnel A. Then the molten material was evenly poured into the funnel from whence the material ran to the joint, filling the same. Then the funnel was withdrawn and the metal permitted to cool and harden. Solid joints of this kind can be made very readily.

One day it was necessary to remove a collar from a shaft on a wagon. The collar was held so securely by the steel key that the collar could not be freed from its seat. After trying various plans for the removal of the collar, a series of small holes were bored into the metal of the shaft adjoining the key as at D, Fig.

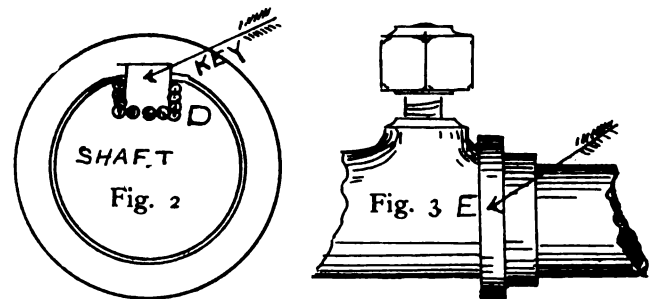

2. After the holes were drilled into the shaft to nearly the depth of the steel key, the key was very easily moved and taken out. In order to restore the bored seat of the key to a condition for further service, the seat in the collar was equalized in dimensions, so that it was possible to insert a larger key and make a tight fit.

The shoulder of a clamping set screw union cracked. This

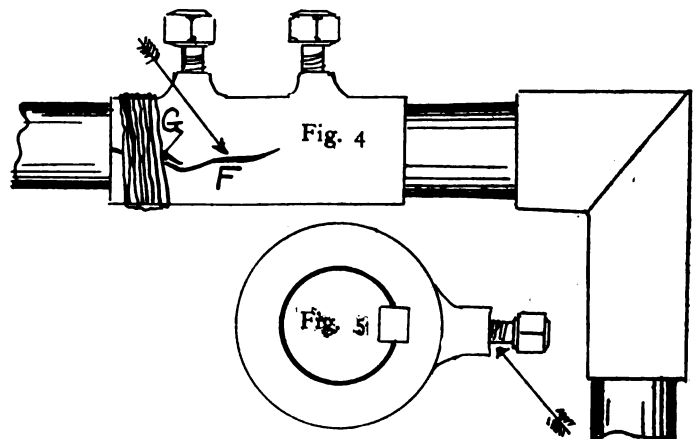

shoulder was fixed by making a wrought iron ring. The ring was then shrunk over the shoulder of the cracked union as E, Fig. 3. This ring served to retain the union firmly in position regardless of the fracture. The pressure of the ring closed the crack and permitted the set screw to be turned until the point of the screw contacted firmly with the metal surface of the union by simply

turning down the metal of the shoulder at that juncture in a turning lathe. I have seen rings of this order fitted to place and brazed over with good results. Then again, instead of the brazing, the ring is secured in place with some pins driven through bores made through the work.

Occasionally one sees a bad job on steel tube connections in vehicle repair and construction shops. In a certain shop where some vehicles were in progress of repair and overhauling, my eye caught a wire wrapped joint as at G, Fig. 4. It seems that in the using of the vehicle the frame of steel had collapsed at that juncture and one of the screws in the terminal of the union exerted pressure on the interior tubing in such way that the exterior metal was expanded until it split. The crack, G, thus made

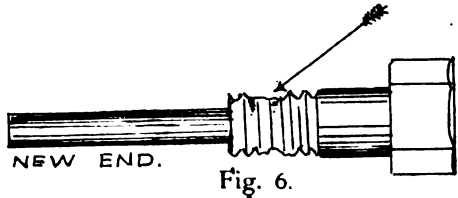

Fig. 6.

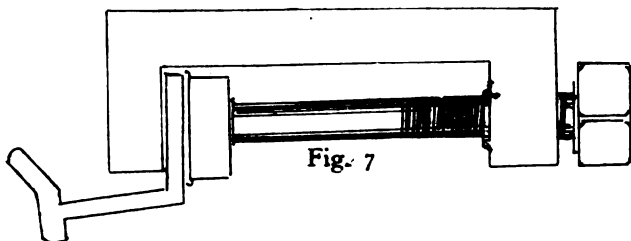

Fig. 7

was then crudely wrapped with wire. The crack extended along the line as at F and greatly weakened the joint so that the connection wobbled. We had to remove this union and substitute a new one. It is almost impossible to make a tight joint with a fractured connection of this kind even if a new end is made and flushed over the broken section as is sometimes done. It is policy to have new parts on hand for substituting whenever necessary.

Still many old parts can be saved. In some shops the junk pile is very often liberally decorated with partly worn and only slightly defective parts. In one place I found a number of good collars thrown aside due to slight defects in the threads of the adjusting screws at the arrow point in Fig. 5. It is possible to

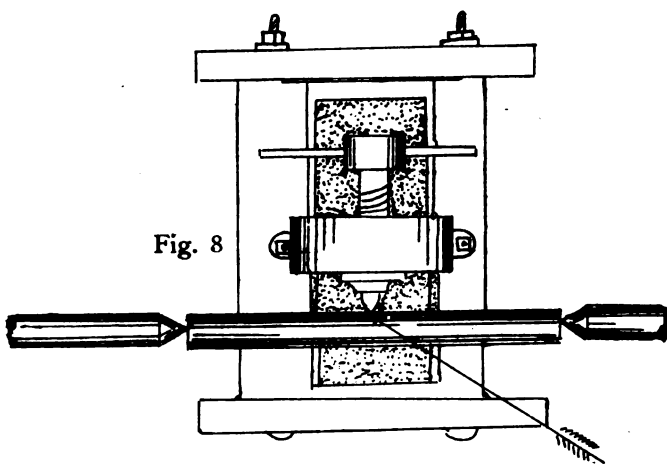

Fig. 8

save many parts of this nature by removing the set screws with the worn or broken threads and replacing the same with new set screws. On one occasion we turned the imperfect set screws from a number of parts of this pattern and then made new set screws from a lot of old screws of larger diameter. We turned off the work threads and made new surfaces on the screws as in Fig. 6. Then new threads to fit the threads of the collars were cut and in this way considerable old stuff from the junk pile was saved for the firm.

Fig. 7 is a handy clamping device for any shop where vehicles are in process of making or repairing. The body part is wrought

iron and can be made any size desired. The adjusting screw is inserted in the threads cut in the bore in one end of the neck and with this screw you can clamp work against the other neck and retain the work securely in position.

Fig. 8 is a trueing rigging for getting alignments on crooked shafting. The line of shafting is held in the turning lathe be-

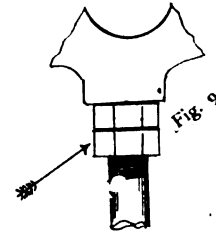

tween the chuck points as shown. The adjusting point consists of a turning screw fixed in the threaded journal attached to the upright of metal or frame of hardwood bolted together. This frame is fixed to the turning lathe frame. You do the trueing by turning the adjusting point. After getting the point set to correspond with the alignment of the spindle, you can true the spindle in the usual way until the point registers even all around.

When troubled with wire spokes turning loose from the hubs of wire wheels, and when the spokes are held in place with single nuts, the loosening trouble can be overcome by adding one more nut as in Fig. 9. The second or lock nut binds on the original nut and holds the same tight.

ELECTED NEW OFFICERS.

The Michigan Retail Implement & Vehicle Dealers' Association has elected the following officers: President, William Goodes, Flint; vice-president, A. L. Gleason, Copemish; treasurer, Otis Baylan, Kalamazoo; to fill vacancy on board of directors, D. M. McAuliffe, Albion; directors for two years, Warren List, Howard City; James A. Wagner, Kinde; Charles A. Slayton, Tecumseh; J. F. Folmer, Vicksburg. Fully 400 members attended the Jackson meeting.

EXPLAIN WHY BUGGY BUSINESS IS GOOD.

Students of the situation say the extraordinary figures reported by the large concerns are due to the fact that the old established organizations which added motor car making to their business did not abandon their first love, while the minor concerns which either quit or temporarily shut down their plants created a condition making it impossible for the existing concerns running at regular capacity to supply the normal demand. The wagon business of the Mitchell-Lewis Motor Company has grown to such large proportions that \$300,000 is being invested in new buildings at the company's plant in Racine, Wis., to take care of it. The outlay has been two and a half million dollars in the plant since it was established seventy-six years ago.

B. & B. BUGGY CO.

The stockholders' meeting of the above named company in Battle Creek, Mich., declared an initial dividend. The company did its best year's business during the past year. Under the management of J. M. Borough, this company has been placed upon a dividend paying basis, and while three years ago the stock could have been purchased very cheap, it is to-day worth par. The profits, it is said, would have warranted a much larger dividend, but for the fact that a factory will be built next spring. The building will be of brick or concrete and the main portion will be 300x80 feet, and there will be a wing at each end 50x75 feet. The stockholders elected the following officers: President W. E. Bosley; vice-president, W. H. Arthur; secretary and treasurer, Miss Anna McDermott; General manager, J. M. Borough. These with F. A. Stewart, were elected members of the board of directors.

Description of Fashion Plates

The twin auto seat buggy from the factory of the Parry Mfg. Co. shows a seat with flared back and sides, very comfortable for the passenger, full brass trimmed top, high shifting rail and a fancy dash. The top joints are of the outside extension kind. The painting on gear is red or bronze green; body black. The trimming is in cloth or whip cord, with leather where indicated. The buggy is made in two tracks.

A good wagon is shown in the full platform cut-under delivery wagon made by Parry Mfg. Co. The ironing is heavy enough for hard work. Gears are of the Settle make, spring ribbed. Body iron bound at corners, iron stripped bottom, panels ironed on top, side panels bolted through sills, drop end gate, and all the practical going to make up a serviceable, useful vehicle.

A very neat, as well as attractive style is shown in the Stanhope body buggy made by the D. M. Sechler Carriage Co. The padded dash is of good pattern, and the trimmings, whether of cloth or whipcord, are substantial. Plenty of leg room, and a comfortable seat for the passenger, which are the good points in buggy designing.

The Concord buggy will always be a popular style as it serves so many conditions, and serves them well. In example shown from the works of the D. M. Sechler Carriage Co., is a good one. The lines of body are good to look at, and the finish and materials used are up to Sechler standard.

The Kissel Kar truck is the production of the best ideas in commercial cars by practical engineers. It provides dependability, durability, low operating cost and low maintenance. Highest grade materials are used. Some of the special features are universal joints in the distance rods which adjust the load and nullify excessive strains incidental to uneven roads—the final drive is double side chain, from jack shaft to two rear wheels. One of the special features is a patented differential lock with foot lever control which applies traction to both rear wheels at the will of the driver. This feature is not only convenient and a time saver, but also necessary in the mechanical construction of a truck. Dust proof and oil tight chain cases—spring suspension such as carries the engine without vibration whether truck is loaded or empty. Transmission is selective type, four speeds forward and reverse, with direct drive on third speed, and geared up 25 per cent on fourth, which provides for speed when not loaded without racing the engine. Clutch cone is leather faced, with springs under leather with self-seating throw-out bearings; double universal joint between clutch and transmission; tires 36x4 front, 4 in. dual rear; rear wheels spokes 16x3½ located in center of felloe.

The latest Coffin production is the Hudson "33" shown in this issue. The power plant is noteworthy for simplicity and accessibility to all parts. The magneto is at the front. The fan is in the flywheel. Tappets are inclosed in dust-proof coverplates, and for a car of its size, frame is heavy. Everything has been made automatic where possible, and all parts are easily got at. The body design is pleasing, the door is hinged forward, giving good entrance, and the seating adjustments are designed for room and comfort for both passenger and driver.

The Lozier cars are made on "built like a watch" plan, and are worthily high-cost. They have achieved reputation by deserving it. We show a recent model in this issue.

CAME UP WITH THE ANTE.

The Heaton Wagon Co., of Neosho, Mo., will move to Fort Worth, Texas, as the \$10,000 bonus has been raised.

MEETING OF CINCINNATI CARRIAGE MAKERS' CLUB.

The regular monthly meeting of the Cincinnati Carriage Makers' Club was held at the Business Men's Club, Cincinnati, Thursday evening, November 10.

J. Frank Hutcheson, of the Spokesman Publishing Co., and Oscar Schroth, of the Anchor Buggy Co., were admitted to membership, and the resignation of George Fisher, of the Fisher Carriage Co.; M. L. Dobbys, of the James Murdock, Jr., Co., and I. J. Cooper, of the Morgan & Wright Co., were accepted.

An interesting address was made by David Gibson, formerly connected with the O. Armleder Co., on "Advertising and the Cincinnati Carriage Manufacturers' Opportunities." He urged that a concentrated effort be made by all the carriage manufacturers through the medium of trade journals and also through some advertising bureau, to advertise Cincinnati as the center of the carriage industry.

The president appointed a committee of three to go into this matter and report at the next meeting. Addresses on the same subject were made by E. M. Galbraith, of the Lion Buggy Co.; H. C. Drake, of the Higgin Mfg. Co., and P. P. Hunter, of the American Carriage Co.

The club also had the pleasure of entertaining Louis G. Meyer, formerly of the James & Meyer Co., who was one of the charter members of this club.

The president announced that the club had sustained a very severe loss during the past month by the death of one of its prominent members, E. H. Busch, who was the president of the Cincinnati Iron and Steel Co. A committee, consisting of E. V. Overman and E. M. Galbraith, was appointed to draft resolutions of regret.

NEW WAGON FACTORY IN WASHINGTON.

The Washington, D. C., Chamber of Commerce has concluded a deal with the National Wagon Co., to build in Hollywood, a suburb of the capital. The name "humane" has been chosen because of the patented pivoted spindle used on them eliminates the "whip" or lateral swinging of the wagon pole caused on all ordinary wagons by the front wheels striking obstructions.

These wagons may be hauled with the heaviest load over the roughest roads without the slightest "whip" of the pole. By this feature alone the team is relieved of a large amount of worry and strain, and the draft of the wagon is made much easier. In addition there is no tendency for the obstructed front wheel to deviate from its forward course, and all the force or momentum in the moving load helps to carry the wheel over the object in its path.

Another important feature is the "double turn." The rear wheels are made to turn similarly, but in the opposite direction from the front ones, so that they track with the front wheels when turning as well as when traveling straight ahead. This gives twice the turning capacity of the ordinary wagon and eliminates all danger when turning of the rear wheel striking a post or other object when the object has been passed by the front wheel.

NOT ENOUGH.

The Stoughton Wagon Company, of Stoughton, Wis., has refused an offer of \$1,050,000 for its annual output. The proposition came from the Rock Island Plow Company.

FREIGHT OFF HICKORY SPOKES.

An order was issued by the Interstate Commerce Commission reducing the freight rates on hickory spokes from Ft. Wayne Ind., to Cincinnati, from 27 to 17 cents a hundred pounds, and from Chattanooga to Cincinnati from 23 to 13 cents a hundred pounds. The order takes effect in December.

Carriage and Automobile Painting

WINTER VARNISH.

Are you ready for the winter? Is your varnish room in as good shape as it can be put? Is the pane of glass a complete one, and clean?

Cleanliness is the greatest factor in varnish room success at any season, and a good place to commence is on the window glass.

Daylight can be prolonged by this means, and day light at this time of year needs to be coaxed. A weak and uncertain light filters through the cleanest glass, but with glass unclean, there is not light enough to even swear by.

No man under the depressing circumstances of bad light struggling through smoky looking windows, need wonder that he does not feel up to his work, and that things don't seem to go right, and everything seems to need twice as long to do as it ought to take to do it.

Brighten up; save eyesight and time, keep mentally cheerful. One way to do it is to have light. Let there be light was the first creative command that made this earth habitable and beautiful, and has made possible the wonderful things man can now accomplish. Let there be light, therefore. Let the light in by clearing out the cobwebs and dust and have the wall space light and reflective. Let no nook escape your cleansing enthusiasm, and you will never more have to wonder where the dust comes from, as there will be none to come, so long as perpetual motion is kept up.

Dust there must be in spite of all endeavors, but it can be reduced to harmless amounts. That's the best that can be done, and its what you will have to do to secure clean varnishing.

Do the same thing mentally. Get rid of the mind cobwebs. Let in the light. Keep the walls of the temple clear and reflective and you will never be ashamed to look them over.

If you have to depend upon a stove for heating, see that it is right, tight, unbroken and the pipes clean and snug fitting. Let no accidental jar be able to bring down the whole fabric about your ears.

Can you without feeling nervous about it, start a fire so as to get it going in good shape the quickest, and have your confidence in every part of it to leave a good fire when closing the room for the night, and feel free from worry about possible accident? If not please be advised, see to it right away. It won't take long or cost very much, and the neglect of it may produce a disaster that will cause you sorrow, as well as loss of your worldly possessions.

It is to be supposed that the varnish you will need for the winter is already in your possession. It doesn't do varnish any good to lie around freight depots, or to be in transit in zero weather, no matter how carefully the manufacturer packs it for travel. The maker does all he can to get it to you in good condition.

The storage of varnish requires careful consideration. Keep it from extremes of heat or cold as well as you are able. Varnish chilled causes a separation of particles and renders a good piece of work impossible until restored to its normal condition by heating. So prevent its chilling, if you can.

Probably for the small shop, the supply in the half-gallon size can is the most economical, and the best way to purchase. When varnishing days are few and far between, it is just as well to purchase in quart receptacles, though it costs a little more this way.

The half-gallon size will keep a long time, if, instead of taking off the sealed cap of the can entirely, as most do, you merely punch a hole through the center of the cap by means of a large

sized nail, big enough to fit the body of a No. 12 two inch screw, then drop in the screw as a plug until the head of screw rests on the top of cap, then with pressure or hammer, force screw head to a level with the metal cap, buried in just as if countersunk.

You can get the varnish from such a hole by a little pressure on the sides of the can after the manner of pressing an oil can.

Having taken out for your immediate need, replace the screw, as a plug, and let a few drops of varnish fall on its head, and your can becomes practically as air-tight as though unsealed. It will so remain until again needed.

There is another advantage in this method of opening a can. It is almost impossible to pour back into can any left-over varnish. Every painter knows that such a pouring back process is responsible for much bad work. The plan also promotes economy in another way, because knowing he cannot pour back unused material, it makes the painter more careful about pouring out in the first instance what he judges will be about the necessary quantity.

The same amount of care given the varnish to keep it air-tight in its container, and to prevent extremes of heat and cold, should be applied to all else having to do with the use of the varnish, brush keeper particularly, or any color left-overs, so as to prevent their getting fat and unsafe.

FAMILIARITY WITH YOUR VARNISH.

It is an old saying that familiarity breeds contempt, and this may be true respecting varnish—some kinds. But of the true kind the more one becomes acquainted with it the more one respects it. It is not always wise to change brands, once one understands a brand in use, for there is danger of losing something, while at the same time nothing may be gained. While different makes of varnish intended for one purpose are presumed to be made upon one formula, or practically so, still there are factors in the case that will materially alter the product as compared with another brand.

One of the most important things is that varnish should have age. This is costly to the varnish-maker as it means the laying by of capital that is practically doing nothing. Some let the varnish remain in the tank longer than a competitor will and yet both brands may be made after the same formula. That would make a difference in the two, the age. Then there is a difference maybe in the quality or choice of the gum used whereby a cheaper or dearer selection of a gum may be employed. This might make some difference. Then there is the oil used, and so on, saying nothing of the skill employed in the making.

SOUTHERN DEALERS MEET.

The Virginia-Carolina Retail Implement, Machinery and Vehicle Dealer's Association held its annual convention in Norfolk Va. The feature of the opening session was the recommendation by President J. D. Barkley, of the creation of a mutual benefit fire insurance plan, whereby the organization would protect individual members.

REMOVAL RUMORS.

There are rumors that the Florence Wagon Works will probably locate in Sheffield, Ala., on account of advantageous railroad facilities and the liberality toward industrial enterprises displayed by the citizens. No point has yet offered a location so favorably situated for factory, yard and railroad service as this city, and it is confidently believed the factory will locate there.

STATE REVENUES FROM NATIONAL FORESTS.

For the fiscal year ended June 30 last, the United States Department of Agriculture announces the 25 per cent of National Forest revenue which will go to the States for road and school purposes amounted to \$506,194.84. This was \$67,492.03 more than last year, or an increase of a little over 15 per cent. The payments are an offset to the loss of income from taxable property sustained through withdrawal of the forest land from entry under the public land laws.

The amounts which will go to the various States are as follows: Arizona, \$51,229.38; Arkansas, \$2,904.44; California, \$60,752.91; Colorado, \$50,306.19; Florida, \$706.38; Idaho, \$66,074.55; Kansas, \$1,004.67; Minnesota, \$457.37; Montana, \$83,678.38; Nebraska, \$2,820.25; Nevada, \$16,314.33; New Mexico, \$28,529.53; North Dakota, \$63.64; Oklahoma, \$626.10; Oregon, \$39,635.87; South Dakota, \$9,808.93; Utah, \$32,905.49; Washington, \$23,271.89; Wyoming, \$34,704.54.

Noteworthy is the especially heavy increase over the amounts last year in certain states. In California the amount rose by over 25 per cent, in Idaho by over 35 per cent, and in Oregon by nearly 50 per cent. The increases are the result of increased activity in National Forest timber sales in these States and are an earnest of what will happen as the timber supply which the government is caring for comes into full demand. Since the cut of timber will always be limited to what the forests will keep on growing, the income to the States will be permanent, not transitory, as would have been the case if hasty and improvident exploitation had been permitted. According to the calculations of the Department of Agriculture officials the States will eventually receive many times what the forests are now yielding them, for there is as yet on the whole only a very restricted demand for the government's timber.

THE BREWSTER SHOWROOMS.

In leaving New York for the borough across the river, Brewster & Co. do not intend to abandon their New York affiliations entirely. For the exhibition of different samples of automobile bodies, and as a subsidiary salesroom, the firm has leased the old Gallatin house on the southwest corner of Fifth avenue and Fifty-third street, a Fifth avenue business invasion which it is no secret to say struck consternation among some of the old-time residents, who had been doing their best to restrict business encroachments above Forty-eighth street. The house, which is one of the most imposing on the avenue, adjoins the magnificent residence of William K. Vanderbilt, Jr., in the middle of the block, while adjoining, on the Fifty-second street corner is the home of William K. Vanderbilt, Sr.

The Gallatin house has not been altered in its exterior, and the grand staircase and other interior features have also been retained. The alterations which have been under way for several months are practically finished, and the house will be occupied for business at once. The leasing of this residence probably more than anything else, broke the restriction that had been imposed by the Vanderbilt, Sloane and Harriman interests on the vacant northeast corner of Fifth avenue and Fifty-second street. This was the site of the old Langham Hotel, and when purchased by the Vanderbilts at somewhat over \$1,000,000 a few years ago it was restricted to private residences. The corner has been vacant since. Last winter the owners removed the restrictions and the plot was purchased in August by Robert E. Dowling.

This bold Fifth avenue move virtually duplicates a similar move of the Brewster firm back in the 70's when they leased the old mansion on the northwest corner of Fifth avenue and Fourteenth street for their uptown salesrooms. Delmonico's then was on the opposite corner, but with this exception the neighborhood was exclusively residential.

The firm dates from 1856, when there was a reorganization of the older concern. James Brewster, the grandfather of the pres-

ent head of the firm, William Brewster, was the founder. His early career is in keeping with the traditional history of successful merchants. He was a poor Connecticut boy. After his apprenticeship in the carriage making business he started for New York in 1809, but when passing through New Haven discovered an opening. He built up a large business there, and about 1825 opened a branch store in New York at 52 and 54 Broad street. Later the headquarters was at 396 Broadway, and in 1856 the Broome street factory was opened. There it remained until 1874, when the uptown factory was built, being the first building on the Broadway site between Forty-eighth and Forty-ninth streets. This removal brought other carriage dealers into the locality, and for years the section from Forty-second to Fiftieth streets was the centre of the carriage trade. Henry Brewster a son of the founder, carried on the business until his death, and his son, William Brewster, is now the head of the firm which was made a corporation about seven years ago. Of the early partners who have since retired the only one surviving is C. J. Richter.

"They called this part of Broadway 'goatville' in my early days," said William Brewster recently, "and that was not so very long ago, for I was born in 1866. All that I dimly remember of the site was that it was covered with enormous rocks."

"There is no carriage trade, properly speaking," Mr. Brewster said. "We have given it up entirely. We make no carriages except on special order, and most of these orders are for vehicles for horse show purposes. Perhaps we make fifty carriages a year. That's some falling off from 1,000 or more only a short time ago."

Up to fifteen years ago the section of Broadway north of old Long Acre square retained its characteristics as the carriage trade centre. None of the old firms are to be seen now, and the few that still retain the old name are, like the Brewster firm, more interested in automobile business than in horse-drawn vehicles. The removal of the Brewster concern eliminates the last of the once famous carriage dealers from the Broadway district.

NO HARM DONE.

Geo. F. Thompson, of Minneapolis, says he and other buggy builders can say "boo" to the automobile. "True, it has affected, to a certain extent, the manufacture of high grade broughams and covered carriages, but the demand for the ordinary buggies is as great as ever. Judging by the number of automobiles in use, all over the country, one would think there would be little or no use for horses, and yet it is a fact that horses are higher to-day than they were a decade ago. One reason for our better business is that a great many carriage factories have been turned into automobile factories. I have been over several states recently, and I find that the country, generally speaking, is prosperous."

PUT THEM IN YOUR ORDER.

Any articles that have scored the success of Vanadium Varnishes, and the yet more recent Vanadium Color Varnishes, both making a climax of achievement, must be interesting to the painter.

It is the desire of every wielder of the varnish brush to produce a rapid result that will be a credit to his manipulation in the permanency and brilliancy of the surface.

The actual use of the varnish is the only satisfactory way to estimate its worth. A willingness to try the new things and observe if they substantiate the claims made for them is the only way a painter can acquire actual knowledge. No other kind of knowledge is of any value to him. It should excite his professional curiosity to test the claims made by Valentine & Company for these two most recent products from the laboratory, that have scored so successfully.

The progressive varnishers are the men whose minds are always open to conviction, and who are willing to test the claims made by firms of known responsibility.

We offer these suggestions to our painter-readers.

National Horse Show.

Barring the sloppy and cockney management by some of the high-browed underlings of the Horse Show personnel, a pretty good display was made and an unusually large crowd was gathered, to see the latest Paris and New York creations in gowns and furbelows.

New paint and yards upon yards of yellow and white cheese cloth were dabbled about as ornamentation. The bars of the ring were raised and nicely calculated to meet the level of the average pair of eyes, so that a healthy neck-stretching exercise by the

hicles were on the shabby order, as if they had done duty many times before, and had not been repainted for this occasion.

The camera men, the pencil and pad artists, the milliner's understudy, and all other classes of horse experts were just as busy as farmers during harvest, and the exhibits were snapped and sketched galore—but it was the human, not the animal exhibits. And how the exhibits did seem to like the annoying attentions of those impudent, unabashed "people," don'tcherknow.

The most oft-quoted names in "society" filled all the classes.



Championship Prize Team of Shetland Ponies.

groundlings could be practised if they were truly bent on observing the functions going on in the ring. This was also a well-devised arrangement to cause the spectator to desist from indulging his curiosity as to the doings on the tanbark, and to turn to a glare and stare attitude devoted to box occupants. The box holders were entitled to this attention, as good, round prices were paid, and large outlays were devoted to looking the part of those who were the cream, separated from the human skim milk at one dollar per entrance.

The judges looked just as spick and span as they ever did; they were as Chesterfieldian to the ladies, and the same ring-master, who has officiated for years, was just politeness and subserviency to the most finished degree. He also had a new pair of trousers of a different cut for the occasion. He must have had a peep at the "breeks" of the foreign military men at the full dress rehearsal, and hied himself to the tailor with despatch.

The horses and harness were new and of the best, but the ve-

There were Reno refugees, second-hand wives of distinction, actress ladies who had succeeded in marrying onto the next highest rung of the ladder, also ladies of true social distinctions with ready-made families of different names by different living husbands, in short, everybody who was anybody by grace of industrious use of the society pages of the Jeerness Yellowplush New York Sunday editions of the daily palladiums of freedom. Oh, yes, and the horses, they, too, were a part of the show.

Following we collate a report of the features of the show:

"The plan of the American Hackney Horse Society to hold a breeders' show in New York next year is one that has been favored, not only for hackney horses, but for trotters, draughters and various other types and breeds. Such shows are held in London every year under the auspices of the Hackney Horse Society, the Shire Horse Society, and the Hunter Improvement Society, and they have been of incalculable benefit to horse interests

there," so with that gracious imitation, which is recognized as the sincerest form of flattery, we propose one for New York.

"As a curtain raiser to the National, which is the plan purposed, a hackney show might be quite an all around event, for besides the classes exclusively for hackneys at the Garden there were hackneys and half-bred hackneys in the pony classes, the hunter classes and the saddle classes, while the high stepping harness classes were made up almost wholly of hackneys, though they did not so appear in the catalogue. Instead of being difficult to fill out a full day's program with competitions exclusively for representatives of the breed the real difficulty might be to find a place on one day's card for all the hackney classes that could be filled. In the few classes exclusively for hackneys at this year's show the number of entries was small and the exhibit as a whole was by no means representative of the breed, yet the show was full of hackneys and half-bred hackneys in open classes all through the harness, saddle and hunter divisions."

There was great glee among the folks when one of the international events was pulled off. One of these events furnished the liveliest sort of comedy, as well as some excitement. With one of the biggest crowds in the history of the show, officers of the armies of Great Britain, France, Holland and United States undertook to jump their horses over a three-foot hedge and a fifteen foot strip of water. A cement tank about three inches deep had been placed in the arena and filled with water. The officers in uniform were to clear it with their mounts. The three-foot hedge was placed at the "takeoff." The best jumpers in the great armies of the world were entered. Lieut. Gordon Johnston, U. S. A., with a grin on his face, knowing from his experience last year that there would be fun, galloped into the arena among the first. He was riding "Rear Guard." The horse landed rider and himself in the water, and was conducted to the gate vanquished.

Lieut. Geoffrey Brooke, an English Lancer, tried next. "He came to the jump like he was trekking across the Transvaal with a detachment of Boers after him and no English soldiers in sight, and he was well drenched when Alice landed in the middle of the water.

The victorious animal in this event was Harriet II., ridden by Lieut. Brooke. Second honors went to Lieut. Mallarme of the First Joigny Dragoons. He rode his bay mare Oka. England captured third money, too, when Lieut. C. F. Wallwyn, of the Royal Horse Artillery, was successful with Gaby, a bay mare. Col. George M. Dunn, United States Army, took fourth prize with his chestnut gelding, Samar. He was ridden by Lieut. I. S. Martin, of the Fourteenth Cavalry.

The event for roadsters was one of the most interesting and the awards were the most popular of any of the show. The blue ribbon went to E. C. Leed's Lorna Doone. This bay mare easily outclassed the other nineteen horses.

Had it not been for the customs officials Walter Winans would have been a strong bidder for the blue ribbon in this event, with his chestnut gelding, Bonnie View. When Mr. Winans brought his string into this port his horses were allowed to pass the customs officials, but his carriages were held up, despite the fact that he had announced that he intended to ship them all back and expressed his willingness to give bond. The conditions required that the owner must own the wagon drawn by his entry, and Winans neglected to buy a wagon here, thinking the dispute would be settled before the time for the showing of this class arrived. But it was not, and Winans did not show. The red ribbon went to E. T. Stotesbury's Norceta and the yellow to W. M. V. Hoffman's Teneriffe.

Judge W. H. Moore had so many horses in the classes that he was always in the public eye, and his collection of awards was by far greater than any other exhibitor. His Robin Hood and Debator were the best in the classes shown to victorias, appointments to count.

The most unpopular award of the whole show was when Judge Moore with his bay mare Lady Seaton was given the

English Hackney Challenge Cup, value \$500, over Alfred G. Vanderbilt's brown mare Lady Dillam. Both mares were seven years old. Lady Dillam has shown herself one of the best hackneys ever seen at a horse show in New York. The spectators did not hiss as they did last year when Judge Moore got a decision that nearly all in the Garden except the judges thought wrong, but this year Judge Moore did not get any applause for winning this ribbon. Immediately the decision was announced, many experts who had no interest in the contest, denounced the judges. Lady Dillam was given the second ribbon. Although there were ten other entries no third or fourth ribbon was awarded.

Lord Baltimore and My Maryland, the famous show pair of horses of C. W. Watson, the coal baron, and, save Judge William H. Moore, the most famous horse showman in America, got the gate for the first time in their careers, after being exhibited both in this country and Europe for many years. Not only had they hitherto never had to go out before the awards were made, but never before had they failed to get either a blue or a red ribbon. Never before had they even to take a third or fourth ribbon.

The event in which the downfall of this famous pair came was the class for pairs of mares or geldings shown before victorias. Horses counted 50 per cent, carriages 25, harness 15, liveries 10.

In the show around the ring Lord Baltimore and My Maryland showed up as well as Lord and Lady Seaton, the pair of Judge Moore that got the blue ribbon. But when all were lined up Lord Baltimore got cranky and began to kick and My Maryland joined him in that performance for a moment. They were ordered out, and as they went through the gate the coachman and footman, who had shown them so many times, always getting the ribbon, broke down and wept.

There were only four entries in this class, but prizes were given only to two. The pair of Alfred Vanderbilt, Queen's Maid and Queen's Favor, met the same fate as Lord Baltimore and My Maryland. When the judges stood in front of this pair and ordered them to back the two mares refused to move. They were promptly given the gate. Dignity and Manhattan, the entry of Paul A. Sorg, captured the red ribbon.

The central figure at the horse show was Walter Winans, the American who was born in Russia, lives in England and never saw the country of which he is a citizen, although he is 50 years old, until a few days ago. In the three harness events for horses of the classes in which his string were entered he got the gate twice.

The first great big and continuous applause of the Horse Show came when Morris & Co.'s six-in-hand Clydesdale team entered, drawing a great truck. The audience was the largest of this year's show and their hands broke loose on sight. As the caravan circled and rumbled by the applause merely grew, wave on wave; the railbirds got into the noise with their feet on the boardwalk.

The exhibit by Morris & Co. deserved it. Six herculean Clydesdales, with great curves in neck and haunch, jingling brass chains and bobbing their high pointed collars, circled at a quick-step, a walk or a gallop, at command. The vehicle they drew was a great bodied freight van with a red box, yellow wheels and two sidelamps beaming like searchlights. The big arena suddenly seemed small.

Then at a touch along the six lines the evolutions began. First in big circles, then in smaller, faster and faster, in figure-of-eights, at a crashing gallop a-chase of their tails. They stopped short, sung around to the left so as to put the leader's nose on the truck tail board; then to the right, short against the front hub. Then out again, doing figure-of-eights and crack-the-whip. The outfit looked like a locomotive at play, the headlights helping the simile. Only comparable to the size of the thing was the grace of it. Such elephantine ease and gambols were never seen on the tanbark.

Another gay and sounding exhibit followed; it was a class of road coaches. Judge Moore and W. Gould Brokaw had each a coach-and-four entered, and Paul Sorg had two. Morris Howlett, the professional who drove Brokaw's Magnet coach, took the

honors in conduct. Judge Moore showed himself next best whip. Of course each outfit had its Dalmatian on top, tongue out but silent, and its tooting blarer on the long horn was there, too.

William Grant drove Sorg's second coach, the Old Sports, and the fine going team took the ribbon. Judge Moore was second."

An event of lively interest was the class for children's ponies. One of the conditions was that the ponies were to be ridden by boys or girls under twelve years, the sons or daughters of men not professionally interested in the purchase or sale of horses.

There were five entries and the juvenile riders comported themselves with as much dignity as any of the elders had done until Raymond Francis on Black Beauty tried to pass Miss Audrey Josephthal, nine years old. Now Miss Audrey is some equestrienne and she was not going to have a mere boy run away from her and her piebald gelding Spot, no matter if she was on the tanbark, and not out on the road.

"Huh, what you trying to do, beat me?" asked Master Francis over his shoulder. "No girl can do that."

And the race started. The ringmaster held up his hand for them to go slower, but that did not matter. The judges frowned, but what did the displeasure of the judges count beside a race? So round and round the arena they went four times, when the girl and the piebald won out. When they had all lined up and the judges finished congratulating little Miss Josephthal on her riding, they gave her the white ribbon, or fourth prize. They were not willing, however, to see the boy lose, so they gave him the yellow ribbon. The blue ribbon was won by Master William Rogers Coe on Llwyn Twilight, a bay mare. His brother, Master Robert Douglas Coe, got the red ribbon with Llwyn Georgie, a bay gelding.

The show closed with a list of 1,740 animals having been exhibited, and the largest number of paid admissions in its history.

We illustrate the Shetland pony team that gathered first honors.

AUTOMOBILE PRICES.

Mr. Flint, of the Moon Automobile Co., has had himself interviewed about the prices of motor cars, and while his argument is a special plea for the car in which he is interested, and while he does not stick to his text, but rather elaborates his special plea to the Moon, yet it is opinion as it is made in the motor car trade, and is interesting as bearing on the subject of price, in which many are interested at the present time, and of which we are to hear a good deal in the near future. Says Mr. Flint:

"We have all heard much recently about the reduction in price of automobiles; in fact, many people seem to think that the price of automobiles are bound to be reduced very shortly. Let us go over the matter carefully.

"In the first place, material and labor are both much higher than they ever were before. Take tires, for an example. Here is one item alone that advanced twenty per cent in the last year; [It seems to us we have heard it said tires are to be had for less, rather than more money, at present.—Ed.]; labor has advanced ten per cent; material has advanced fully fifteen per cent. It costs more to market cars to-day than at any time in the history of the automobile industry, because there has not been the demand during the last year, largely owing to the inclemency of the weather during the spring and summer months. [The inclemency of the weather is unique, and really a new reason for relaxed demand.]

During this period some of the largest manufacturers made up large numbers of cars which they have recently thrown upon the market regardless of price because they had to sell them. This, of course, made buyers scarcer and it made it harder to sell cars, but the time has come when the buyer demands real value for the money invested. He has learned that an inferior car is a poor investment at any price. [Therefore, the only poor cars are made by the "largest manufacturers" made up in "large numbers," and they have drugged the market to the extent of causing the in-

vestor to learn "that an inferior car is a poor investment at any price."]

"The really good cars which are built by manufacturers who are putting the best material and labor into their product are being held at their established prices, and in many cases these prices have been advanced, rather than to cheapen the quality of their product. As a prominent manufacturer says, it is simply a case of water seeking its own level, and some manufacturers have been getting more for their product than it is really worth.

"Many persons who are not well informed regarding the manufacture of cars seem to think there is great profit in making automobiles. [There can be no question of the prevalence of that opinion. It is gathered from the statements of the men who say they have gathered in "the great profit."] Look over the list of persons who were manufacturing cars two years ago and you will find that a large number of them have either failed or have been absorbed by other firms. There are very few automobile factories that are really making money—it is not all profit. While it is true very many factories have made extensive improvements investigation will reveal the fact that the most of these improvements are made on increased capital and not on the profits.

"Any one outside of the factory cannot appreciate the enormous amount of money that is spent in experimenting and perfecting cars. Few persons realize that each factory has a corps of expert engineers at work at all times to perfect and improve the cars, and that every new improvement that appears means months of careful experimenting, study and expenditures. No factory can really put a good car upon the market without first testing and experimenting with its car a year or so before it is even offered to the public. Then there is the price of jigs, dies, patterns, tools, etc., which must be spent before the car is offered to the public.

"It is true a few manufacturers have made a great deal of money out of the automobile business. [Reversal of former statement.] but they are comparatively few and most of this money was made in the earlier years of the automobile industry, and from the present outlook it appears that the majority of manufacturers will improve their product and the prices will remain the same."

DEALERS' CONVENTIONS.

Southwestern Kansas and Oklahoma Implement and Hardware Dealers' Association, Wichita, Kan., December 6, 7 and 8.

Wisconsin Retail Implement and Vehicle Dealers' Association, Milwaukee, December 13, 14 and 15.

Minnesota Retail Implement Dealers' Association, Minneapolis Minn., January 10, 11 and 12, 1911.

Idaho Retail Hardware and Implement Dealers' Association, Boise, Idaho, January 13 and 14, 1911.

Western Retail Implement and Vehicle Dealers' Association, Kansas City, Mo., January 17, 18 and 19, 1911.

Pacific Northwest Hardware and Implement Association, Spokane, Wash., January 18, 19 and 20, 1911.

Colorado Retail Implement Dealers' Association, Denver, Colo., last week in January, 1911. (Subject to change.)

Southern Illinois and Missouri Retail Implement and Vehicle Dealers' Association, St. Louis, Mo., January 24, 25 and 26, 1911.

Oregon Retail Hardware and Implement Dealers' Association, Portland, Ore., January 24, 25, 26 and 27, 1911.

North Dakota and Northwestern Minnesota Implement Dealers' Association, Devils Lake, N. D., first week in February, 1911. (Subject to change.)

New York Retail Implement and Vehicle Dealers' Association, Rochester, N. Y., February 2 and 3, 1911.

Retail Dealers' Hardware and Implement Association of Texas, Houston, Tex., February 14, 15 and 16, 1911.

If your advice is worth anything, people are willing to pay for it; if not, they would not have it as a gift.

ECONOMIC IMPORTANCE OF HICKORY.

Of American hardwoods none would be more difficult to replace than hickory in case of a shortage in supply. It is not used in such quantity as white oak, or yellow poplar, or maple, but it is used for a number of special purposes for which it alone is satisfactory. The wood of the hickory is not remarkable for beauty of color or of grain, it shrinks badly in drying, it is not durable in contact with the ground, and it is very liable to attack by insects; on the other hand it is heavy, hard, strong, stiff, and very tough. No other commercial wood, native or foreign, combines these properties to so great a degree. The hickory spoke and rim and the hickory shaft have made possible the American type of spring vehicle with its superior lightness and strength; the hickory handle has helped greatly to make the American axe known all over the world.

The Forest Service has cooperated with the National Hickory Association, an organization of the users of hickory who have foreseen a coming shortage in the supply, and who have united to help prevent it, to study the different species, and to suggest means to produce and maintain the necessary supply.

There are no accurate figures of the annual cut of hickory. The census returns for 1908 show a cut of about 200,000,000 board feet. This is intended to include, however, only the material actually cut and sold as lumber, while much of the hickory cut is not lumber. In 1908 an additional cut, equivalent to about 135,000,000 board feet, was worked up directly into other products, such as spoke billets, handle blanks, and rim strips, difficult to reckon in board feet. This gives a total consumption, excluding fuel, of about 335,000,000 board feet, allowing for all necessary waste. If, however, the unnecessary waste, both in the woods and at the mill, were included, the total amount of hickory consumed would probably be not less than 450,000,000 feet.

The vehicle industry uses more hickory than any other, is most dependent upon it, and takes about 65 per cent of the total cut. In America spokes, rims, poles, shafts, singletrees, doubletrees, spring bars, and axle caps of spring vehicles are all made of hickory; and more than one-half is used for spokes. In Europe oak, ash and acacia are also used, but they are admittedly inferior, and probably could not be substituted for hickory in American vehicles without a radical alteration of design and a serious loss of lightness and strength, for which the American types are celebrated. About one per cent of the annual cut of hickory is used in the manufacture of automobile spokes and wheel rims.

In the manufacture of heavy wagons about 9 per cent of the total output of hickory is used mainly for axles, but also for neck yokes, single and double trees, brake bars and crossbars. Sometimes it replaces oak for the spokes, although it does not last so long under the trying weather conditions to which wagons are so often exposed.

The tool-handle industry annually uses about 80,000 cords, or 10 per cent of the total cut, of hickory for axe, pick, hatchet and other handles which require toughness and strength. Other woods are used for handles, notably hard maple and white oak but their use is limited and local. The agricultural implement business uses about 8 per cent of the total cut of hickory for singletrees, doubletrees, axles, cross-bars, mower pitmans, eveners, neck yokes, spokes, and rims. The quality demanded is much the same as in heavy wagons, and oak could, in many cases, be used just as well.

Hickory is the best American fuel wood and costs about 25 per cent more than any other. It is probable that the greater part of all the hickory cut is used for fuel, and this portion may amount to 1,000,000 cords. Not a little of this, even to-day, is material of the best quality, which should be saved for the spoke and handle maker. In the past tremendous quantities of the finest hickory have been burned.

The use of hickory saplings for hoops has in the past been very important, but is now on the decline. The hickory barrel

hoop is recognized as the best wooden hoop, but it is more expensive because it has to be made by hand, and is, therefore, giving way to the patent elm hoop and to iron and wire. The prices of hickory hoops have fallen 20 per cent during the past ten years until 7-foot hoop poles bring only \$5 per thousand cut and delivered, and there is now little profit in them. This is really fortunate, from the point of view of prolonging the hickory supply, because hoop poles require straight, clean saplings from 1 to 2 inches in diameter and from 10 to 15 feet high; this means the destruction of the most promising young growth and the leaving of scrubby and knotty specimens as the basis of the future crop, and has, in fact, secured the survival of the unfit.

A great deal of American hickory is used in the vehicle industry abroad. It is exported chiefly in the form of bent rims, spokes, and shafts, but a great many finished wheels and logs are also sent. About 5 or 10 per cent of the annual output is used in this way. In addition, large quantities of hickory, both in finished and unfinished form, are sent to Canada.

PHILADELPHIA CARRIAGE AND WAGON BUILDERS' MONTHLY MEETING.

"Credits and Collections" was the principal subject for discussion at the monthly meeting of the Carriage and Wagon Builders' Association of Philadelphia, Pa., which was held Friday evening, November 18th.

That more care should be taken in extending credit, and that when a debtor promised to pay he should be made to come up to his promise was the general expression.

The rental lease was commenced as a means for the protection of the carriage builder when selling new work, but it was advised that care be taken in the wording of the lease, so as to make it a rental lease and not a bill of conditional sale. Nearly all the members had something to say on the subject.

An invitation from Hoopes Bro. & Darlington, West Chester, Pa., to visit their large wheel factory on November 29th, was accepted.

VEHICLES IN ARGENTINE REPUBLIC.

All varieties of vehicles are seen in Rosario and the vicinity, from the 2-wheeled cart to the finest modern carriage. In Rosario writes Consul Henry P. Coffin, there are 510 licensed victorias (4-wheeled), for hire, and they are liberally patronized by the public. In addition to these there are several hundred private equipages.

Most of the wood used in the manufacture of wagons comes from the forests of Argentina and consists chiefly of quebracho and algarroba, both varieties forming very durable and last materials. Pine imported from the United States is used for the body part. The greater part of the tires, clips and bolts are made in Argentina. The springs are all imported from Europe, and on arriving in this country are disposed of in a very short time, as the demand far exceeds the supply. Axles for the lighter carriages are also imported. Products such as gears, springs and axles should find a ready market here.

TO EXHIBIT NEW SOLID TIRES.

At the motor commercial car show to be held in Madison Square Garden, New York, the first of the year the Firestone Tire and Rubber Co. will exhibit something entirely new in solid truck tires, a demountable rim tire. The Diamond Rubber Co. will have a new spliceless solid tire on exhibition.

AWARD TO F. W. GREENE.

The Interstate Commerce Commission has awarded F. W. Greene, receiver of the Ionia (Mich.) Wagon Co., damages for freight overcharges made by the Alabama Great Southern Railroad.

CONSOLIDATION EFFECTED.

National Implement and Vehicle Association Formed, Composed of A. A. I. & V. M., Wagon Makers' Association, Plow Association and Others.

A new organization embracing the National Wagon Manufacturers' Association, National Plow Association, National Association of Agricultural Implement and Vehicle Manufacturers, and others will begin operations on January 1. The officers will be:

President—E. D. Metcalf, International Harvester Co., Auburn New York.

Treasurer—C. A. Pattison, Peoria Drill & Seeder Co., Peoria.

Secretary and General Manager—E. W. McCullough, 1100 American Trust Building, Chicago, Ill.

Vice-Presidents—W. A. Taylor, Niles & Scott Co., Laporte, Ind.; Wm. A. Loudon, Loudon Machinery Co., Fairfield, Ia.; S. M. Nones, Kentucky Wagon Mfg. Co., Louisville, Ky.; E. P. Curtis, Richardson Mfg. Co., Worcester, Mass.; B. T. Skinner, Port Huron Engine & Thresher Co., Port Huron, Mich.; A. T. Stevens, John Deere Plow Co., St. Louis, Mo.; Richard Graves, Ohio Rake Co., Dayton, O.; R. S. Buch, Buch's Sons Co., Elizabethtown, Pa.; J. S. Baker, Baker Mfg. Co., Evansville, Wis.; Fred N. Bateman, Bateman Mfg. Co., Greenwich, N. J.; Judson Buchanan, Chattanooga Plow Co., Chattanooga, Tenn.; C. B. Dempster, Mill Mfg. Co., Beatrice, Neb.

The offices formerly occupied by the Wagon and Plow Associations, Suite 1100 American Trust Building, Chicago, will become the general offices of the new association.

It is expected that not only will the pleasant relations which have always existed between the old organizations and the retail dealer and the organizations representing him be continued, but in all questions of mutual interest these relations will be strengthened for the benefit of the entire line.

VEHICLE FACTORY FIRE LOSSES.

The National Fire Protection Association has issued a tabulation of its record of carriage and wagon factory fires covering a total of 147. Of these 53 were due to causes common to all risks, 18 per cent to boilers and fuel furnishing, 14 per cent to heating and power and 5 per cent to oily material. Forty-six cases were due to special hazard causes, forging and forges leading with 10.1 per cent, wood working machines 7.1 per cent, painting and varnishing 6.1 per cent, and finishing and painters' rags 4 per cent. Forty-four of the fires were due to unknown causes.

As to location, 18 per cent of the fires started in storage and non-manufacturing rooms, 13 per cent in the boiler room, 21 per cent in general wood working departments, 13 per cent in painting and varnishing departments and 10 per cent in the smithy.

Thirty-six per cent occurred during the day and 64 per cent at night. Thirty-nine per cent started while the plan was in operation and 61 per cent while it was not in operation. Seventy-five of these fires occurred in sprinklered risks, the equipment operating satisfactorily in 63 per cent of the casing, holding fire in check in 31 per cent and working unsatisfactorily in 6.7 per cent. In 33 per cent of the fires only one sprinkler opened, in 51 per cent two or less and in 77 per cent less than ten.

WAGON FACTORY LANDMARK SOLD.

The Pennsylvania Railroad Company has purchased from the Fulton and Walker Company, Philadelphia, Pa., the large factory building at the southwest corner of Twentieth and Cuthbert streets, together with the building, 33 and 35 North Twentieth street. The price paid by the railroad company was \$325,000 which is considered a very good one. It was necessary for the railroad to acquire the Fulton and Walker factory in order to carry out the improvements which it has already begun.

CONVENTION OF AMERICAN ROAD BUILDERS' ASSOCIATION.

The American Road Builders' Association will hold its seventh annual convention at German House, Indianapolis, Ind., on December 6, 7, 8 and 9. In connection therewith will be a congress of road builders and a "good roads show."

The sessions of the convention and congress will be devoted to the presentation of a number of technical papers on the subjects of road and pavement construction and maintenance by leading highway officials, discussions of the papers and of matters pertaining to the work of highway improvement, and to addresses by prominent men interested in, and identified with, the various phases of the work. The program will comprise papers and addresses covering every phase of road and street improvement and treating the subject from the viewpoint of each of the many classes to which it is of moment.

The membership of this association includes the foremost road making and street paving authorities of the United States and Canada—men occupying the chief administrative and engineering positions in the highway departments of states, counties, cities and towns. The experience of those men embraces work with all the materials and methods used in the construction of country roads and city streets and the building of highways under the varying conditions encountered throughout the country. The opportunities afforded by the conventions of the association to learn from these men, both through the papers prepared and presented by them and by personal meeting with them, renders the annual convention of the association the chief event of the year in road building circles.

The exhibition of materials and machinery will form an important feature of the convention. Ample exhibition space has been obtained in German House and the grounds connected with it thus bringing the meetings and the exhibits together and allowing attendance upon both without the loss of time. The exhibits will include the various materials and the most improved machinery and appliances for road making and street paving. The greater number of exhibits will be shown in the German House while the larger and heavier machinery will be displayed in the adjacent grounds.

The meetings and exhibits will be open to the public and a general invitation is extended to everyone interested in any branch of highway work.

JEWEL CARRIAGE CO. INCREASES CAPITAL STOCK.

The Jewel Carriage Company, of Carthage, Ohio, at a meeting held November 11, passed a resolution to increase its capital stock from \$250,000 to \$400,000. The entire new issue will be preferred stock, 2,000 shares at \$100 each, bearing 6 per cent interest, payable annually. Of the increase \$100,000 will be first preferred cumulative stock, and the balance, \$50,000, non-cumulative.

OBJECT LESSON IN VAUDEVILLE.

The Omaha I. & V. Club at a recent smoker staged a skit that told the story of the absurdity of price-cutting. More than 600 spectators, visitors and delegates applauded the players and rose to uproarious cheers when the "plot" was unfolded. The denouement was intended to show the evil results that follow an implement dealer's efforts to put his competitor out of business by cutting prices.

BLACKSMITHS AND WHEELWRIGHTS MEET.

The fifth convention of Nebraska Horseshoers, Blacksmiths and Wheelwrights Association was presided over by President Fogerty. More than one hundred were in attendance.

RECENTLY GRANTED PATENTS OF INTEREST TO THE VEHICLE INDUSTRY.

962,297—Resilient Tire. John Baar, Philadelphia, Pa.
 961,844—Fifth Wheel. Sanders Craig, San Diego, Cal.
 962,010—Vehicle Wheel. Frank R. Dudley, Fitchburg, Mass.
 962,207—Wheel Construction. Orlando A. Frick, assignor to The Turnbull Wagon Company, Defiance, Ohio.
 961,955—Elastic Tire for Vehicle Wheels. Boleslas A. Godek Paris, France.
 961,861—Dumping Truck. Wm. H. Hunt, New York, N. Y.
 962,353—Whip Socket. Hezekiah Ingram, Wabbaseka, Ark
 962,229—Vehicle. Elias Lange, assignor to H. Lange Wagon Co., Pittsburg, Pa.
 962,366—Wagon Tongue. August Lindberg, Melvin, Iowa.
 961,976—Hitching Attachment for Wheeled Vehicles. Wm. D. P. Lowry and P. J. Walling, Minneapolis, Minn.
 962,230—Pneumatic Tire. Wm. A. Lurie, Chicago, Ill.
 962,231—Wagon Box Fastener. Henry E. Macy, Chapman township, Clay County, Kansas.
 961,882—Wheel and Tire Therefor. George D. Moore, Worcester, Mass.
 962,385—End Gate for Wagons. Wm. Plogmann, Davenport, Iowa.
 962,247—Connection for Vehicle Wheels. Albert F. Rockwell, assignor to The New Departure Manufacturing Company, Bristol, Conn.
 962,256—Vehicle Body Support. Albert F. Rockwell, assignor to The New Departure Manufacturing Company, Bristol, Conn.
 962,258—Vehicle. Albert F. Rockwell, assignor to the New Departure Manufacturing Company, Bristol, Conn.
 962,259—Support for Vehicle Bodies. A. F. Rockwell, assignor to The New Departure Manufacturing Company, Bristol, Conn.
 962,056—Draft Equalizer. Wm. Schluter, Parkersburg, Iowa.
 962,266—Combined Low-Wheeled Wagon and Sled. Henry S. Somsen, Raymond, Idaho.
 962,066—Vehicle Wheel. Franklin Tompkins, New Dorp, N.Y.
 962,272—Auto Sleigh. Oscar J. Tubbs, Waterville, Me.
 962,487—Vehicle Top Bow Holder. Sherman T. Allen, Detroit, Michigan.
 962,615—Tire Plug. Leon A. Bourquenez, Botsford, Conn.
 962,814—Means for Securing Tires to Vehicle Wheels. Charles G. Cabanne, St. Louis, Mo.
 962,557—Vehicle Spring. William E. Eastman, Boston, Mass.
 962,703—Auxiliary Spring for Vehicles. John Eckhard, Boston, Mass.
 962,631—Wheel Construction. Chester A. Frick, Defiance, O.
 962,633—Rear Axle Construction. Royal H. Gilbert, Lakewood, Ohio.
 962,955—Means for Lubricating Axles, Bearings and the Like. Wm. J. Greening, Middletown, N. Y.
 962,637—Foot Rest for Vehicles. Hallie D. Hansford, Sylvester, Ga.
 962,897—Pneumatic Tire. Wm. B. Hartridge, Seaford, England.
 962,442—Wagon Brake. Curtis D. Linton, Paint Bank, Va.
 962,775—Wagon Brake. Henry M. Mahan, Clanton, Ala.
 962,444—Solid Tire for Vehicle Wheels. Albert Mans, Dieghem Belgium.
 962,778—Wheel Tire. Thomas Midgley, Columbus, O., assignor to The Hartford Rubber Works Company.
 962,975—Resilient Wheel. Alexander H. Peloubet, Newark, N. J.
 963,015—Sleigh. Barton M. Wentworth, assignor to G. A. Bodwell, Somersworth, N. H.
 963,271—Wheel Tire. Charles E. Blechschmidt, Connersville Indiana.
 963,503—Dumping Coal Wagon. Thomas E. Bond, Baltimore Maryland.
 963,361—Emergency Brake for Vehicles. Herman F. Dietz Liverpool, assignor of one-half to A. Will, Syracuse, N. Y.
 963,704—Spring Support for Wagon Tongues. Emanuel Foers-ter, St. Paul, Minn.
 963,286—Whip Lock. James A. Frazer, Los Angeles, Cal.
 963,558—Wagon Brake. Olof Hill, Revelstroke, B. C., Canada
 963,372—Producing Front Yoke Axles. Alfred Johnson and C. L. Bockus, Detroit, Mich.
 963,304—Vehicle Wheel. Walter W. MacFarren, assignor to W. H. Donner, Pittsburg, Pa.
 963,608—Vehicle Brake. Randolph N. Martz, Frederick, Md.
 963,240—Steering Wheel. Arthur G. McPherson, Highland Park, Ill.
 963,615—Sled. Fred A. Miller, Cadyville, N. Y.
 963,320—Tire. Ira E. Peck, Cranston, R. I.
 963,397—Wagon Hoist or Lift. Rip G. Roulstone, McKenzie, Tenn.
 963,667—Pneumatic Tire Protector. Gustave Vergote, Marshall, Minn.

963,411—Whiffletree Connection. James H. Whan, Mertilla, Kansas.
 40,757—Design. Automobile Body. Edwin L. Thomas, assignor to E. R. Thomas Motor Company, Buffalo, N. Y.
 964,462—Vehicle Wheel. Joseph M. Benham and G. W. Slater. Oakland, Cal.
 965,854—Vehicle Body. James A. Bicher, Frankfort, Ind.
 964,379—Vehicle Light. Wiley S. Bond, Lincoln, Kas.
 963,990—Vehicle Wheel. Samuel E. Chapman, Oakland, assignor of one-third to W. M. Woodward, Fruitvale, Cal.
 964,215—Wheel. Mason J. Clark, Newark Valley, N. Y.
 963,870—Vehicle Spring. Dorr R. Close, Chicago, Ill.
 963,750—Cushion Tire. Gustave Debladis, Paris, France.
 964,151—Runner. John R. Faber, Mount Pleasant, Michigan.
 964,235—Wagon Jack. Wm. V. Gist, Sparta, Tenn.
 964,477—Shaft Tug. Fred M. Henshaw, assignor of two-thirds to J. B. Grigsby and H. D. Dougherty, Dallas, Texas.
 963,902—Draft Evener. George E. Koehler, Ainsworth, Iowa.
 963,782—Flexible Tongue. Irwin Lester, Tuscola, Ill.
 964,113—Vehicle Lift. James R. Lockard, Marlin, Texas.
 964,038—Differential Axle Device. Melkon Markarian, Fresno, Cal.
 964,039—Truck. Arthur Marvin, assignor to Marvin Mfg. Co., El Paso, Texas.
 964,049—Pneumatic Tire. Milton T. J. Ochs, Allentown, Pa.
 963,930—Vehicle Brake. C. W. Olson, assignor of one-half to C. Linge, Portland, Oregon.
 963,937—Joint or Coupling for Vehicles, Reaches, etc. Samuel J. Pearson, assignor of one-half to J. M. Brasington, Bennetsville, S. C.
 963,943—Wagon Brake. Henry E. Rolph, St. Paul, Minn.
 964,319—Draft Equalizer. Wm. Schoennecker, Kenmare, N. D.
 964,345—Brake Attachment for Vehicles. Wm. W. Walton, Santifee, W. Va.
 40,761—Design, Vehicle Lamp. Herbert M. Dawley, assignor to The Pierce-Arrow Motor Car Company, Buffalo, N. Y.
 964,358—Tire Remover. Harry B. Young and R. Palomino, Shafter, Texas.
 964,738—Spoke Tenoning Machine. Gus Avery, assignor of one-half to W. Donovan, South Bend, Ind.
 964,894—Whip Socket and Lock. Millard P. Ballenger, Tiger-ville, S. C.
 965,080—Draft Evener. James E. Caywood, assignor of one-third to F. E. Farrell and one-third to C. A. Barnes, Jackson-ville, Ill.
 965,133—Trotting Sulky. James H. Dickson, Philadelphia, Pa.
 964,632—Vehicle Wheel, Sebastian Z. de Ferranti, Grindleford England.
 964,648—Tug Fastener and Detacher. Isaac Jones, Topeka, Kas.
 964,795—Tire Heater. Uno H. Laurin, Cleveland, Ohio.
 965,122—Spring Wheel. Joseph P. Paulissen, Kankakee, Ill.
 965,032—Manufacture of Wheels. Edwin E. Slick, Pittsburg, Pa.
 965,033—Making Wheels or Circular Bodies Having Peripheral Treads. Edwin E. Slick, Pittsburg, Pa.
 Copies of above patents may be obtained for fifteen cents each by addressing John A. Saul, solicitor of Patents, Fendall Building, Washington, D. C.

RECENTLY EXPIRED PATENTS OF INTEREST TO THE CARRIAGE INDUSTRY.

Patents Expired October 10, 1910.

506,419—Center Plate for Vehicles. Francis P. Davidson, Joliet, Ill.
 506,458—Vehicle Brake. John A. Appell, St. Louis, Mo.
 506,508—Vehicle Brake. Luther C. Jaques and George F. Kester, Spokane, Wash.

Patents Expired October 17, 1910.

506,814—Vehicle Running Gear. Andrew Dratt, San Francisco, Cal.
 506,986—Wagon Tongue. William C. Dowling, Alpine, Mich.

Patents Expired October 24, 1910.

507,129—Vehicle Spring. John H. Hipple and Van L. Mulf Media, Pa.

507,158—Wagon Brake. John H. Ozley, Weldon, La.

Patents Expired October 31, 1910.

507,563—Wagon Running Gear. William H. Smith, Albion, Indiana.

Patents Expired November 7, 1910.

508,379—Wheel Guard for Vehicles. Henry F. Ganon, Chicago Illinois.

The above list of patents, trade marks and designs of interest to our patrons are furnished by Davis & Davis, solicitors of American and foreign patents, Washington, D. C., and St. Paul Building, New York City.

U. I. MOTORS PRODUCT TO BE ANGLICIZED.

Automobiles Will Conform to the British Taste and Will Average Low in Price.

Benjamin Briscoe, president of the United States Motors Company, has some interesting things to say of the plan to make and sell cars of American type and of fairly low cost in England. Mr. Briscoe got back Thanksgiving Day from the other side. He was away three weeks. In that time he collected the vital figures on the foreign automobile trade, put them together, sketched out the lines of the British Company, the United International Motors, Ltd., and got back again, ready to go ahead.

For one thing this isn't going to be a "dump" of American cars on the British market. Mr. Briscoe learned when he was over there that the British don't like certain things about American cars because they don't conform to British ideas. He learned too that it was a waste of time to attempt to swing the British public around to any other way of thinking than the one they have.

He says that if an Englishman makes up his mind to a thing it's better to let him have his way about it. Therefore the cars that will be presented to the motor buying public will be American in a sense. But they will show such alterations as to conform with the taste abroad, that is in England, and for the matter of that will be Anglicized American cars. They won't be known as Maxwell or Stoddard-Dayton or Columbia or what not, because they won't be completely any one of these types. They will be known as U. I. M. cars.

Prices will range from £115 to £275. The 1911 product of the U. I. M. factory is to be 4,000 cars. These two statements are not at all surprising to Americans, perhaps, but they mean something revolutionary in England. For instance England, which is the leader in quantity and value in automobile manufacture this year, as she was last, made only about 19,000 cars in 1909. France manufactured 12,000 and Germany 8,000.

The U. S. Motors alone made about 35,000 cars, and the American product was perhaps 150,000 cars. Mr. Briscoe says the idea of wholesaling product does not occur to the foreign maker and he does not care for the idea of economizing men. For instance one man is used to tend one gear cutting machine in England. In this country he might look after four.

The main thing about the British situation is that over there the cars of less than £200 are just six. "And they are jokes," Mr. Briscoe says. They do not come near the car of that cost in this country. The British manufacturer makes for the classes, not the masses, and the idea over there still is that the automobile is a luxury.

"It hasn't occurred to them," says Mr. Briscoe, "that the automobile is useful in getting about and can be made so that it is less costly, taken all in all, than the horse-drawn vehicle. They never have thought, apparently, that it would be worth while to make a car for the middle class. Of course, for one thing the mechanical system is not in lines that will permit of scaling down costs. They haven't devoted themselves to the problem as we have here and that's the reason why I think the English situation presents a fine chance for us."

Mr. Briscoe went on to explain some other differences in situation between the American motor buyer and the British consumer. He said that in England many folks have funds invested on the incomes of which they live. If they buy automobiles it is a case of doing it with the principal. So they have to figure the thing out very carefully.

And they insure the car, once purchased, against every sort of thing. Damage, depreciation and the like are insured against at varying premiums, and long before the Briton takes unto himself a car, that is a man of not the greatest wealth, he has the thing all ciphered out. The American buys an automobile and expects to pay for it and its upkeep by "making a little more money next year."

Although 4,000 cars seems a great output to England it isn't

much for this country. The reason that it is to be comparatively small is that the factory accommodations will be limited and the cars will be turned out with less rapidity. Then again there is no desire to astound the British by making too big a turnout.

As to the sentiment against American motor cars Mr. Briscoe said: "This is a heated term politically in England. The Conservatives have been making much of tariff reform and the intended invasion of their country by us was used as political material. Speeches were aimed at us just for political capital, and there was much talk of us coming over to take the wages out of the British mechanic's mouth.

"Now as a matter of fact the figures I collected show that the average wage of the sort of mechanic we want is 16 cents an hour in England. And top notch men they are. Over here we pay 26 cents an hour for the same sort of work. Do you believe that we are going to kick on paying 16 cents in England? Not much; nor 17 either. So you can see just what some of that talk amounted to."

As matter of fact the U. I. M. will be thoroughly English and practically a British factory. It will be a case solely of adapting the American cars to a foreign surrounding.

Average prices of automobiles in England range about \$1,900 Mr. Briscoe's trusty book of figures shows. The average price is about \$1,300 in this country. The introduction of about one-sixth of the 1911 product at an average of say \$900 will bring the English figures down somewhat.

Cars of the United States Motors Company have had a comfortable sale in England recently, Mr. Briscoe reports. In the show time and while he was there about 380 were disposed of.

Americans have not cultivated the market, he believes. Last year American cars composed only 3.3 per cent of the imports in England. The other countries, France in particular, sold many there, and did it by yielding to British ideas. Mr. Briscoe is perfectly clear that no man can force on the British market anything the Britons don't want.

The U. I. M. plant in England will make chasses, which will be sent to Germany for assembling with the body. American or U. I. M. cars will be sold complete, not the chassis alone, as is the British and Continental plan.

ACQUIRES CONTROL OF CANADIAN TIRE FACTORY.

The Goodyear Tire and Rubber Co., of Canada, Limited formed to manufacture automobile tires in Canada, to avoid the payment of the import duties of 35 per cent ad valorem imposed under the Canadian tariff act of 1907, has acquired control of the factory at Bowmanville, Ontario, established originally by the Bowmanville Rubber Co., which was reorganized in 1898 as the Durham Rubber Co., Limited. The Durham company has been engaged in the manufacture of mechanical rubber goods and tires. The plant is being revised for continuing the manufacture of the same lines. Offices of the concern have been opened in Toronto. In spite of the tariff there has been a considerable sale of American-made tires in Canada. Under the preferential trade relations with Great Britain, tires from the latter country are dutiable in Canada at only 22½ per cent. But during the last fiscal year Canada imported \$158,023 worth of American tires, and only \$32,517 worth from Great Britain.

MAJOR W. W. HARRAL INJURED.

Major W. W. Harral, the well known representative of the Fairfield Rubber Co., of Fairfield, Conn., met with a severe accident on October 3rd, while traveling in the west, caused by falling on stairway, breaking his hip. He is now at the City Hospital at Moline, Ill., where it will be necessary for him to remain for several weeks, but he hopes to be home in time to enjoy Christmas with his family. The Major has hosts of friends all over the United States, who regret to learn of his misfortune, and who will wish him a speedy recovery.

News of the Trade

BUSINESS CHANGES.

Johnson Carriage Co., Oak Park, Ill., increased its capital from \$7,000 to \$20,000.

C. W. Sash has purchased the stock of vehicles, etc., of J. C. McIlrath, in Laurel, Ia.

Charles Roe has purchased the stock of vehicles, etc., of Chas. Carter, in Winner, S. D.

Sidney (Ohio) Mfg. Co., buggies, etc., has increased its capital from \$75,000 to \$100,000.

Jacob Blith has purchased the stock of vehicles, etc., of Dittus Bros., in Glen Ullin, N. D.

F. A. Folsom has disposed of his stock of vehicles, etc., in Ralston, Ia., to A. L. Farr.

Klas & Bruhn have purchased the stock of vehicles, etc., of E. P. Eickhoff, in Tilden, Neb.

J. D. Deveroux has disposed of his stock of vehicles, etc., in Lovilla, Ia., to B. P. Casten.

George Nixon has succeeded to the vehicle business of Nixon & Washburn, in Downs, Kas.

A. Bryon has disposed of his stock of vehicles, etc., in Oxford, Kas., to Hilderbrand & Stattle.

J. C. McMillan has purchased the stock of vehicles, etc., of O. J. Marks, in Belle Plaine, Kas.

Henry Baucher has disposed of his vehicle business in Brighton, Iowa, to William Stout, Sr.

Victor Taubeneck has disposed of his stock of vehicles, etc., in Marshall, Ill., to Harry Casteel.

Nispel & Rains have succeeded to the vehicle business of Elerbeck & Nispel, in Beatrice, Neb.

C. T. Sherwood has purchased the stock of vehicles, etc., of H. J. Willett, in Burlington, Kas.

Hans Severson has purchased the stock of buggies, etc., of F. E. Henderson, in Northfield, Minn.

W. L. Devine has sold his stock of vehicles and implements in Nelson, Neb., to H. Peterson & Son.

The Mel Van Deventer Harness & Buggy store at Panora, Ia., has been purchased by Charles Logan.

Simpson & Fritts have purchased the stock of vehicles, etc., of B. F. McNamara, in Myrtle Creek, Ore.

Holcomb & Mead have disposed of their stock of vehicles, etc., in Springfield, Ore., to Singleton & Son.

John Morgan is about to succeed the vehicle and implement firm of J. S. Jenkins & Son, in Murdo, S. D.

Hugh Dealy, of Paullina, Iowa, has purchased the stock of vehicles, etc., of Ed. Durband, in Struble, Iowa.

M. C. Corley has disposed of his stock of vehicles, etc., in Harper, Kas., to F. O. Allen, of Anthony, Kas.

F. F. Miller, of Lester Prairie, Minn., has purchased the stock of vehicles, etc., of J. Kimpel & Son, in Plato, Minn.

Laws & Schermerhorn have sold out their stock of vehicles, etc., in Brockville, Kas., to Laubengayer & Wallace.

A. J. Robinson has purchased a half-interest in the vehicle and implement business of Hamilton Bros., in Arbela, Mo.

Paul Sieben, of Easton, Kas., has purchased the implement and vehicle business of N. W. Everetts, in Winchester, Kas.

Beichel Bros. Co., Beaver Dam, Wis., hardware, carriages, implements, etc., sold out to Fred Miller and A. J. Schulze.

McParland Kenzoni Lumber, Wagon and Implement Supply Co., Chicago, Ill., has changed its name to McParland and Hardwood Lumber Co.

Barney Keegan, Monmouth, Ill., has sold his interest in the blacksmith shop and wagon factory to his partner, Ed. Holmes, and will retire from business.

Frank Kloepfer, Bellefontaine, O., has associated with him Mr. John Weiland, of Portsmouth, and after January 1 the firm name will be Kloepfer & Weiland.

Frank Mount & Son, Homer, Mich., have sold their vehicle and implement business to Dan F. McFadden, of Marshall, who will have his brother William McFadden, of Chicago, associated with him.

Frank Dopler, Dunkirk, N. Y., wagon manufacturer, is arranging to replace his present shop with a larger and up-to-date factory. It will be of brick and will be equipped with all of the latest devices in his line of business.

The Herring Buggy Company, Mansfield, O., completed arrangements to add a line of automobiles and will open sales rooms and a garage in the central portion of the city. A contract has been closed for the E-M-F and Flanders and practically the whole line of Studebaker make of automobiles.

It is announced that the Silent Sioux Auto Manufacturing Company, Sioux Falls, S. D., which has been manufacturing the Silent Sioux machine in Milwaukee, will at once move the plant to Sioux Falls. A deal has just been made at Fort Dodge by which the Silent Sioux Company purchases 20 acres of land in South Sioux Falls.

NEW FIRMS AND INCORPORATIONS.

Woods Electrical Vehicle Co., St. Louis, Mo.; capital \$2,500.

D. E. Burkley has opened a stock of vehicles, etc., in Alliance, Neb.

W. H. Burroughs has opened a new stock of vehicles, etc., in Concordia, Kas.

Peter Bergen has opened a new stock of vehicles and hardware in Dundee, Kas.

W. E. Hinze is moving his stock of vehicles, etc., from Hamburg, Iowa, to Brock, Neb.

Lee Bodenhamer has engaged in the vehicle and implement business in Springfield, Mo.

Rudolph Meyer is about to engage in the vehicle and hardware business in Cole Camp, Mo.

Berry & McCammon have engaged in the implement and vehicle business in Mankato, Kas.

George Talbot, of Clay Center, Neb., is about to engage in the vehicle business in Verona, Neb.

Edwards, Cox & Gilbert have engaged in the vehicle and hardware business in Yoakum, Texas.

The Hannibal Wagon Co. has been incorporated in Hannibal, Mo., with a capital stock of \$55,000.

The Sterling Hearse & Carriage Co. has been incorporated in Sterling, Ill., with a capital stock of \$10,000.

The McKenzie-Barrett Carriage Co. has been incorporated in Mobile, Ala., with a capital stock of \$5,000.

The Erb-Harper Co. has been incorporated in Laurel, Mont., and will handle a line of vehicles, etc.; capital, \$20,000.

The Star Supply Co. has been incorporated in Elkhart, Ind., with a capital stock of \$5,000, and will handle vehicles, etc.

Capitol Truck Manufacturing Company, Denver, Colo.; \$50,000 Incorporators, Charles A. Scott, T. J. Dickson, T. M. Botterill.

Hannibal (Mo.) Wagon Co., has incorporated; capital, \$55,000. Incorporators Alfred E. Lasnier, Celina Lasnier, N. L. LeBlond.

George Teegarden has leased rooms at 112 West Lincoln avenue, Goshen, Ind., for a period of five years, and will put in a line of buggies and implements.

Sterling Hearse and Carriage Co., Sterling, Ill., manufacturers of vehicles, A. A. Wolfersperger, C. E. Bensinger, H. C. Newell, Roek Falls Mfg. Co., Sterling, Ill.

Mathias, Weber & Co., wagon manufacturers, will begin the manufacture of auto trucks as soon as the company moves into its new quarters on St. Clair street, Dayton, O.

The McKenzie-Barrett Carriage Company, Mobile, Ala., has been incorporated in the probate court. The company is capitalized at \$5,000. Incorporators, T. C. McKenzie and Thomas C. Barrett.

French Auto Top & Supply Company, Chicago, Ill., \$10,000; manufacture and deal in automobile, carriage and wagon tops, shields, etc.; Emil C. Wetten, Charles H. Pegler, James H. Christensen.

IMPROVEMENTS—EXTENSIONS.

The Troy (Ohio) Wagon Works will build a \$12,000 addition to its plant.

The Moeller Wagon Factory, Kansas City, Mo., has built an addition to its original plant.

The Houghton Sulky Company, Marion, O., increased its capital stock from \$50,000 to \$100,000.

The Pekin (Ill.) Wagon Co. has closed a large deal that will increase operating plans almost double.

The Hale Buggy Co., Anniston, Ala., has gotten into its new factory with plenty of unfilled orders booked.

The Wright Carriage Body Company, of Moline, Ill., certified to an increase in capital stock from \$100,000 to \$150,000.

The Brophy Carriage Company, Douglas, Ariz., is making improvements to facilitate the handling of machinery repairs.

The Sheldon Axle Works, Wilkes-Barre, Pa., filed plans for an additional building to be the nut department of the firm's plant.

Williams Buggy Co., Macon Ga., will move into a new two-story building on site of one of the city public buildings which is to be demolished.

Frank Webe & Co., Louisville, Ky., have purchased a lot with a frontage of twenty-seven feet at Floyd and Main streets, and will erect a wagon repair shop on the site.

The Howard Buggy Company plant at Galion, O., is undergoing extensive repairs and improvements and as soon as these are completed active operations will be begun.

The American Auto Manufacturing Company, of Beatrice Neb., has purchased the old plant known as the DuPauw Woolen Mills, in New Albany, Indiana, and will remove its headquarters to that city at once.

Murphy & Ronan, carriage manufacturers, at Albany, N. Y., have sold their property to the New York Central Railroad. They have had plans made for the erection of a new shop, which will have a floor space of 95x100 feet.

The Dayton (Ohio) Auto Truck Company, which was organized about sixty days ago for the purpose of manufacturing a line of commercial cars, purchased the building known as the C. W. Raymond plant, First and Taylor streets.

Curtis Bros., Macomb, Ill., will move into a larger building and will repair and sell new work in the repository. O. D. Gumbart will move out of the premises to be occupied by Curtis Bros., but will not discontinue the vehicle business.

Ordinances vacating parts of various streets and avenues have been passed by the East Moline (Illinois) city council. Four blocks of the vacated streets ran through property purchased by the Mutual Wheel Co., of Moline, on which it is the intention to erect a branch factory in East Moline next spring.

John F. Sharkey is building a large addition to his carriage repository in Whittenton, Mass. The first floor will be devoted to express and delivery wagons with a large harness room. The second and third floors will be used for his stock. The basement will be used for storage of farm wagons and carts. An elevator will be installed. When the building is completed Mr. Sharkey will have storage capacity for three hundred vehicles.

Plans have been made for the most extensive kind of improvement and enlargement by the Mandt Wagon Company, Stoughton, Wis., which will increase the present number of employes by fifty per cent, making a total number of nearly 900 on the pay roll. These plans call for the remodeling of the entire plant, the demolition of the old frame structures erected mostly by the late T. G. Mandt, and the erection in their place of modern two, three and four story brick buildings.

FIRES.

James C. Keith's carriage repository and storehouse at Brockton, Mass., suffered a property loss of \$25,000. Mr. Keith lost \$10,000 on the building and on carriages stored on the two upper floors. On the ground floor were Thomas McNiff's black-

smith shop and George E. Sear's paint shop. McNiff put his loss at \$5,000 and Sears at \$10,000. All are insured.

The stock of vehicles of A. D. Ash, in Rupert, Idaho, has been destroyed by fire.

The stock of vehicles, etc., of W. J. Thorp, in Albion, Wash., has been burned.

The Milburn Wagon Co. has sustained a \$10,000 fire loss in its factory in Nashville, Tenn.

Phenix Iron Co., and McCardle Carriage and Wagon Factory Trenton, N. J., burned. Loss, \$5,000.

Fire at Harrisburg, Pa., destroyed the blacksmith and carriage shops of the carriage works of L. W. Dill.

William McMillan's wagon works at Maysville, Ky., burned November 5. The loss was \$2,000, with small insurance.

The plant of the Ficklin Spoke and Handle Company, in Wilkes County, Ga., was destroyed by fire. Valued at \$3,500; a total loss.

Fire destroyed the Farmers' Union Warehouse at Cairo, Ga. W. G. Baggett & Son, dealers in buggies and feedstuffs, lost about \$5,000.

The wagon, truck and carriage works and repair shops of H. Kaiser & Co., 23rd and Race streets, Philadelphia, Pa., were destroyed by fire. Loss, \$25,000.

The plant of the Ontario Wheel Company, Matane, Que., was gutted by fire November 3. The loss is estimated at about \$75,000, fully covered by insurance.

The New Haven Carriage Co., New Haven, Conn., just escaped a disastrous fire by promptness of fire department. President Atwood sent a \$25 check to the chief in appreciation of the services of the fire department.

BUSINESS TROUBLES.

The Barnes Motor Company, formerly Anhut Motor Company, Detroit, Mich., has filed a petition in voluntary bankruptcy. It schedules liabilities of \$64,242.33 and assets of \$143,540.75 at their face value.

General F. W. Green was discharged November 14 as receiver for the late Ionia (Mich.) Wagon Company. The banks received 100 cents on the dollar and the creditors 72 cents on aggregate claims of \$40,000. The receivership cost \$3,200.

Sheriff H. Wallace Thomas has seized the plant of the Indiana (Pa.) Carriage Company on executions totaling \$15,000. The concern began business under favorable auspices about seven years ago, but receipts have fallen off considerably during the past two years.

The Buckeye Wagon and Motor Car Company of Dayton, O., filed its petition in bankruptcy through its president, Charles Anderson, Jr., who at the same time filed his own petition. The liabilities of the company amount to \$1,517.97, and the assets are given at \$14,045.

Individual petitions in bankruptcy were filed in the district court at Cincinnati by John and Jeannette Rock, carriage dealers of Dayton, Ohio. Rock gives his indebtedness at \$14,503.99, while Mrs. Rock places her liabilities at \$14,003.99. Mrs. Rock recently made an assignment for the benefit of creditors, but only realized \$6,400 out of the property she sold.

The L. H. Tebbetts & Sons Carriage Company, St. Louis, Mo., is defendant in a suit in bankruptcy filed by several manufacturing and jobbing firms. The firms filing the petition and the debts they claim are: Monarch Rubber and Oil Cloth Company, Philadelphia, \$5.49; Columbus Bolt Works, Columbus, O., \$300; T. M. Shearman, San Francisco, \$179; and B. B. Reynolds, of Kansas City, \$783.50. It is alleged that the company committed an act of bankruptcy. The company is a co-partnership of Louis B. Tebbetts and his sons, Alvah M. and George S. Tebbetts.

A petition in bankruptcy has been filed against Rothschild & Co., (corporation), manufacturers of automobile bodies at 550 West Fifty-seventh street, corner of Eleventh avenue, New York city, by Lillian H. Mandel of Mount Vernon, Samuel H. Morrison and Jules Rehaut. Judge Hough appointed Henry B. Singer

receiver, bond \$5,000, and authorized him to continue business ten days. There are contracts on hand for \$50,000 worth of auto bodies. Liabilities about \$100,000 and assets estimated at \$30,000. The corporation was incorporated in April, 1906, with capital stock of \$35,000, which was afterward increased to \$200,000.

The Clark Power Wagon Company, of Lansing, Mich., has executed a trust mortgage to guarantee a bond issue of \$50,000 to take care of outstanding indebtedness and put the company on its feet. A. A. Platt general manager of the company, was made trustee.

The Badle-Clark Sales Co. of De.roit has started suit in the Ingham County Circuit Court for \$100,000 damages against the Clark Power Wagon Co. of Lansing. The Detroit concern alleges it spent money advertising the products of the local corporation and failure to deliver the vehicles resulted in the loss.

Alleging that a deed of trust filed by creditors of the C. Priebe Carriage Company, St. Joseph, Mo., is fraudulent in that it prefers certain creditors over others, proceedings in voluntary bankruptcy were instituted in the federal court. The proceedings indicate a clash between two sets of creditors. W. S. Gregory was named as trustee, and the stock of carriages and other vehicles was turned over to him.

NEW FIRMS AND CHANGES IN AUTO TRADE.

Ashton Auto Co., Sioux Falls, S. D., has incorporated; capital \$20,000.

Warren Motor Car Co., Detroit, Mich., increased capital from \$100,000 to \$300,000.

Lewiston Automobile Co., Lewiston, Mont., increased capital from \$5,000 to \$10,000.

The Herreshoff Motor Co., Detroit, Mich., increased capital from \$140,000 to \$230,000.

The Aldrich Auto Co. has been incorporated in Kalamazoo Mich., with a capital of \$5,000.

The Militaire Auto Co. has been incorporated in Cleveland, O., with a capital stock of \$30,000.

The Mountain City Foundry & Machine Works, of Greenville, S. C., will manufacture automobiles.

The Texas Automobile Co. has been incorporated in Houston, Texas, with a capital stock of \$10,000.

The Moon Motor Car Co., of St. Louis, Mo., has increased its capital stock from \$175,000 to \$300,000.

The Cumback Motor Co. has recently engaged in business in Detroit, Mich., with a capital of \$1,000.

The Northern Automobile Co., of Petoskey, Mich., has increased its capital from \$2,500 to \$5,000.

The Tulsa Automobile & Mfg. Co. has begun the erection of a \$10,000 factory building in Tulsa, Okla.

The Chesterfield Motor Car Co. has engaged in business in Richmond, Va., with a capital of \$15,000.

The Southern Motor Car Co. has been incorporated in Richmond, Va., with a capital stock of \$25,000.

The Ideal Motor Car Co. has been incorporated in Hopkinsville, Ky., with a capital stock of \$10,000.

The Superior Motor Sales Co. has been incorporated in St. Louis, Mo., with a capital stock of \$75,000.

The Hazen Automobile Co. has been incorporated in Memphis, Tenn., with a capital stock of \$25,000.

The Mt. Washington Automobile Co. has been incorporated in St. Louis, Mo., with a capital stock of \$10,000.

The Brooks-Latta Automobile Mfg. Co. has been incorporated with a capital stock of \$150,000, in St. Louis, Mo.

The Stafford Motor Car Co., of Kansas City, Mo., has increased its capital stock from \$100,000 to \$400,000.

The Southeast Missouri Motor Car Co. has been incorporated in Cape Girardeau, Mo., with a capital stock of \$15,000.

W. B. Mitchell, San Marcos, Tex., has sold his interest in the Citizens Auto Co. to W. A. Schrutchin and Marion Wills.

The Thos. B. Jeffrey Co., of Texas, has been incorporated in

San Antonio, Texas, with a capital of \$20,000 to handle automobiles.

Henry Motor Car Sales Co., Chicago, Ill., to manufacture and deal in automobiles; capital \$25,000; incorporated by A. E. DeMange, C. F. Latimer.

Neal, Clark & Neal Co., Buffalo, N. Y., will manufacture and sell automobiles and accessories, capital \$75,000; incorporated by O. L. Neal, H. B. Clark.

Low Speed Turbine Co., Camden, N. Y., will manufacture automobiles and air ships. Capital, \$100,000. Incorporated by John A. McPeal, Harvey L. Reese.

Victor Motor Truck Co., Buffalo, N. Y., will manufacture and deal in motor vehicles, engines, etc., capital \$250,000; incorporated by H. B. Clark, C. M. Miller.

The Sommer Motor Co., Cucyrus, Ohio, incorporated; capital \$125,000. Incorporators, L. A. Sommer, L. M. Smith, S. S. White, F. L. Hopley, D. F. Fohr.

Townsley-Comstock Co., Chicago, Ill., will manufacture automobiles; capital not given. Incorporated by S. E. Comstock, E. F. Comstock, Edward F. Comstock.

Simmons Automobile Co., New York City, will manufacture and sell motors, engines, automobiles, etc., capital \$10,000. Incorporated by John G. Simmons, 2138 Westchester avenue, Geo. L. Lewis, 42 Broadway.

The Lewis Supply Company, Grand Rapids, Mich., organized to manufacture auto parts and metal specialties, has incorporated with \$5,000 capital. Among those interested are James M. Hynas, Richard Ryner and C. F. Lewis.

W. W. Sterling, president of the Sterling Automobile Manufacturing Company, of Elkhart, Ind., announced that he would within a short time establish an automobile factory in Oklahoma although the exact location has not yet been decided upon.

URUGUAYAN OPPORTUNITIES.

Agent Turner reports that vehicles in use in Uruguay are nearly all of English or home make, are far heavier than are necessary for the loads they carry, and are too high from the ground to be loaded easily and with an economy of labor. There is a chance for American-made trucks of 1 and 2 tons capacity, built with a slant to the tail to facilitate loading. Such vehicles would gain the support of the truckmen. Heavy vehicles should be supplied with brakes, as there are hills about the business section of the city. The retail delivery wagon is a very high cart, with limited carrying capacity. Light delivery wagons find a ready sale. The horses are large and could easily handle all that anyone would care to load into a delivery wagon.

Harness is mostly of English pattern, heavy, and well mounted, with brass trimmings. Leather wears well, and with lighter wagons American-made harness should be sold in large quantities. The horses all being heavy, rubber hoof pads could be introduced to advantage. I saw several horses with quarter crack starting in their hoofs. This is easily remedied on hard pavements by the use of rubber hoof pads.

Local wagon makers import most of their wagon parts from England. The hardware is massive, the springs being far wider and with more leaves than are required in the States. Almost every vehicle has springs, as I saw not over a half dozen carts on the docks with their loads on a dead axle.

There are many fine carriages in Montevideo, but very few rubber-tired vehicles were noticed. It is said that the pavement is so rough and hard that they wear out too quickly and are too expensive. If victorias and coupes were fitted with 1½ inch tires of rubber, they would last quite as long as elsewhere. The pavement is what is called in America "Belgian block" and is no harder there than in the United States. The climate is not particularly hard on rubber. Rubber-tired vehicles are not in more general because they have not been pushed. The city has just let a contract for 30,000 square meters of asphalt pavement to be laid, and this will be followed by more of the same kind. European patterns of carriages are all that can be seen. The surrey or straight-sill carriage is almost unknown.

OBITUARY

Grant H. Burrows—The death of Mr. Burrows at Burlington, Vt., which had been his home for some years, has taken from the carriage building industry a man of prominence and probity. Mr. Burrows was a large factor in the buggy trade of Cincinnati at one time and was regarded as a man of exceptional capacity for large enterprises. He was an ex-president of the Carriage Builders' National Association, and one of its most brilliant members, especially as a banquet speaker. His wit and humor was of original cast and most pleasing. His personality attracted all to him, and his unflinching poise as a Christian gentleman caused him to be loved as well as respected.

After leaving Cincinnati as a field of work, he went to Canada, and was successful there.

His death was due to a paralytic stroke which rendered him a confirmed invalid. He is survived by a wife and six children.

Frederick Schelp, retired carriage builder, 83 years old, father of George H. Schelp, secretary and treasurer of the Joseph W. Moon Buggy Company and Moon Motor Car Company, died November 27 at the home of his daughter in St. Louis, Mo., following an illness of more than a year. He was a pioneer resident of Ballwin, St. Louis County, where he carried on a wagon and repair business for forty years.

Leander McCord, formerly a well known carriage manufacturer, died recently at his apartment No. 97 East avenue, Rochester, N. Y., aged 73 years. Mr. McCord retired from active business about five years ago and had not been in good health since. Bright's disease and a heart affection were the immediate causes of death.

Andrew Willard Burnham died at Royalston, Mass., November 25. Mr. Burnham was a native of Lubec, and for years before the Civil War, was foreman of the woodworking department of the carriage and sleigh factory of C. P. Kimball in Portland, Me. Mr. Burnham was in his seventy-second year.

Augustus Mayer, a retired carriage manufacturer, died November 25, at his home in Belleville, N. J. He was 72 years old.

Charles H. Williams, a pioneer sleigh manufacturer of Wirtsboro, Mass., died in San Diego, Cal., at the age of 83 years.

Patrick J. FitzGibbon, a well known carriage builder of Trenton, N. J., died at his home in that city, October 20.

George E. Garretson died at his home in Russellville, Ky., October 28. He was a retired carriage manufacturer.

William Spybey, aged 82 years, a retired carriage builder of Louisville, K. Y., died at his home November 12.

Charles S. Wangler, a well known wagon builder of Pittsburg, Pa., died November 6, at the age of 66 years.

Henry J. Paye, a wagon maker, died at his home in West Hoosick, N. Y., November 14, aged 78 years.

Eugene Hellreigel, a former carriage manufacturer, died at his home in Dayton, Ohio, recently.

GRAMM'S NEW AUTO FACTORY.

B. F. Gramm, vice-president and general manager of the Gramm Motor Truck and Car Company, which is completing a \$300,000 factory at Lima, Ohio, stated recently that the concern would start off in January with a working force of 400 men. The plant is designed to employ 1,000 men, with a capacity of 5,000 cars per annum, or a gross annual business of \$10,000,000.

MEETING OF GASOLINE ENGINE MEN.

The annual meeting of the National Gas and Gasoline Engine Trades Association will be held in Racine, Wis., December 12 to 15. An elaborate program for the sessions and an interesting exhibition has been arranged.

CATALOGUES RECEIVED.

Lull Carriage Co., Kalamazoo, Mich., has issued a very well designed and printed catalogue of the "Kalamazoo Kind." It is its No. 14 issue, and well illustrates and describes the light, medium and wagon work the factory produces. The explanations and instructions in the foreword are as clear and to the point as a dealer could desire.

The Gramm Motor Car Co., of Lima, Ohio, has issued a really superior catalogue as regards illustration, printing and binding. A good feature is the side thumb-nail index permitting quick reference to any dimension chassis needed, that is made by the concern. The Gramm motor and chassis are the kind the wagon builder is absorbingly interested in, because they afford him a rare chance to develop the wagon business on new lines.

A feature of the Gramm construction is its demonstrated ability to cope with the loads the truck is designed to carry. Everything is built up to the capacity standard. This is not usual, which is why it is mentioned in this connection. We think this catalogue should be in the hands of all wagon builders of prominence enough to make the body work for these trucks. Those who have incorporated the Gramm chassis in their work have found it a profitable venture.

The D. M. Sechler Carriage Co., Moline, Ill., catalogue No. 16 is to hand. The buggy builder these days certainly does himself credit in the matter of the literature he broadcasts in the trade at what we suppose must be a considerable outlay. In this catalogue, printing and clear descriptions of the work vie with one another.

Emerson Carriage Co., Rockford, Ill., present a beautiful example of the art of catalogue making and say, "this catalogue is issued to enable you, after careful discrimination, to arrive at that stage of experience where you are ready to select your carriage builder." We think this statement is well considered, and that dealers will take a real pleasure in looking over the examples of work illustrated.

Parry Mfg. Co., Indianapolis, Ind., are out with a new catalogue that is as pretty as a painted wagon. It is also most intelligently compiled for the convenience of the dealer. We will show some of the more recent styles in this issue of The Hub, taken from the catalogue.

MR. WEIBER ON ELECTRICS.

Mr. C. Z. F. Weiber, of the Rauch & Lang Carriage Co., of Cleveland, has this to say about the electric driven vehicle: "Electric cars are far more generally used in the Western cities than they are in most eastern cities, but that is due no doubt to the fact that most of the factories making electric cars are located in that section. You will see hundreds of electric cars in every leading city of the Middle West and I am glad to say that Rauch & Lang electrics are found in large numbers wherever the electric is known. I am quite sure that it will be equally popular in the East, once its advantages are made apparent."

NEW SUPERINTENDENT.

The announcement has been made that A. A. Woodruff has accepted a position as superintendent of coach work at the Pierce-Arrow Motor Car Company's factory in Buffalo. Mr. Woodruff has been for the last three years connected with the E. R. Thomas Motor Company, and previous to that time was in business for himself. For several years he was associated with the G. W. and H. D. Crawford Co., of Delhi, N. Y., and at the same time maintained a retail store of his own at 48th street and Broadway, New York City. He later was at the head of the Woodruff Manufacturing Company, which business he afterwards sold out to Rothschild & Co. Practically all of Mr. Woodruff's experience has been with high class carriage work.

FOREIGN AUTO SHOW.

Visitors from Abroad Will "Receive" in State Fashion at the Hotel Astor, New York City.

Automobile salon is a most appropriate name for the exhibition of foreign-made motor cars, which will be held in this city during the week beginning January 2, for it will be staged and conducted as an exclusive drawing room affair. Its social features bid fair to rival those of the former automobile salons in Paris.

The definite announcement that the importers would hold a separate exhibit assures four automobile shows in this city during January. The others are the Grand Central Palace show, which will be held at practically the same time as the salon, and the pleasure and commercial motor vehicle shows in Madison Square Garden. The importers' automobile salon will be held at the Hotel Astor. Three of the Astor's largest rooms, including the celebrated ballroom and the rose room, aggregating 18,000 square feet of floor space, are to be thrown together for the occasion. Music will be provided by a large orchestra and private boxes for the accommodation of spectators will be one of the innovations.

The importers feel that by holding an independent show, and one more in keeping, perhaps, with the select character of their cars, they will be enabled to give an exhibition that will appeal more directly to the class of patrons whom they seek to interest. The rooms that have been set apart at the Astor are large enough to afford each exhibitor enough space to prevent the crowding together of the various cars. In this way the cars will be shown to better advantage, and, at the same time, crowding and discomfort on the part of the spectators will be avoided.

The new models of practically every well known foreign car on the market in this country will be exhibited at this salon. Panhard & Levassor, A. Massenat, general manager, will exhibit the Panhard car; the Darracq car will be shown by Henry Ducasse & Co.; Paul Lacroix, general manager of Renault Freres' selling branch, has arranged for a full exhibit of Renault cars; while six new models of the De Dion Bouton car, three of which have been especially designed for the American market, will be shown by E. Lascaris, general manager of the American selling branch.

The Benz Import Co., Jesse Froelich, general manager, has made a liberal space reservation for its exhibit of Benz cars; the Itala and the Daimler cars will share the space reserved by A. T. Demarest & Co., and another reservation has been made for the S. P. O. car, of French make. Caesar Conti, who has recently taken the American agency for the S. P. A., has arranged to exhibit the newest models of this Italian car; Emile Voigt of the C. G. V. Import Company, will be in charge of the exhibit of these cars; while Burr & Co., the well known body builders, will show the latest products of their factory mounted on chasses of DeDion and Darracq manufacture.

Another interesting exhibit will be that of the Gnome motor and of the Anzani motor, both of which are used in the equipment of Bleriot monoplanes. Paul Lacroix is chairman of the committee in charge of the salon, the other members being E. Lascaris, secretary and treasurer, and Warren Demarest.

THE PALACE SHOW.

At the Palace show of automobiles and accessories there will be a section devoted to aeroplanes. One whole floor of the building will be set aside for this feature of the show. Several of the aeroplanes that were imported under bond to take part in the recent aviation meet at Belmont Park will be shown. Particular emphasis will be laid upon commercial aeroplanes so far as they have been developed.

The list of motor car manufacturers signed up so far includes 66 names. The color scheme in which the Palace will be decorated will be a groundwork of cream with crimson trimmings.

NEW SPRING WHEEL FOR MOTOR VEHICLES.

The following description of a spring wheel for motor vehicles which, it is stated, is about to be introduced in England, appeared in the Engineering Supplement of the London Times:

The periphery of the wheel is formed of 18 links, each hinged to its neighbor on either side. These links consist of triangular blocks of wood, and while the bases make up the periphery each of the apices is hinged to a piece of metal which is firmly attached to a volute spring, some 4 or 5 inches in length, according to the weight of the vehicle that has to be supported. The other ends of these volute springs, of which there are 18, disposed radially, are fixed to the hub, or rather to a small inner wheel of the ordinary artillery pattern with 12 spokes.

The springs are made of slightly tapered strips of special steel coiled spirally in such a way that the greater part of each turn is within the preceding one, and that under sufficient compression the whole of the inner coils can be forced within the outermost one. To the surfaces of the links which roll on the ground are cemented blocks of a hard composition of fibre and gutta-percha compacted under pressure, and these, it is stated, can be renewed when worn away at a cost of 4s. to 5s. (97 cents to \$1.22) for each wheel.

The aim of the inventor has been to imitate the action of the pneumatic tires. An obstacle such as a stone does not cause the whole wheel to rise, as is the case with an ordinary iron-tired wheel, but is, as it were, swallowed up, the link or links immediately affected yielding by virtue of the hinges and bringing into play the resiliency not merely of one or two of the springs, but the whole of them round the entire circumference.

The wheel is intended for use on heavy commercial vehicles and motor omnibuses, to give them the benefits of the pneumatic tire without the employment of a particle of rubber. Another advantage claimed is immunity from side slip, while dust is sucked up to a much smaller extent than with pneumatic tires. A short run in London traffic on a pleasure car experimentally fitted with these wheels showed that they afford a remarkable degree of resiliency, and it is stated that their effectiveness is enhanced at high speeds.

NEW HEAD FOR GENERAL MOTORS.

At a meeting of the directors of the General Motors Company, held in New York November 30, four directors of the First National Bank of Detroit were ratified as members of the new board of General Motors. They are: Emory W. Clark, M. J. Murphy, Andrew Green and Thomas Neal.

Later an election of officers was held and James J. Storrow, representative of Lee, Higginson & Company, Boston, was chosen president; W. C. Durant was re-elected to the first vice-presidency; W. J. Mead, general manager of the Olds Motor Works was also elected vice-president, and C. R. Hathaway, secretary and treasurer.

Among other matters considered was the proposed removal of the general offices of the company from New York to Detroit. The First National Bank of Detroit has already distributed over \$4,000,000 in liquidating the debts of the reorganized company.

ANNUAL MEETING OF THE S. A. E.

The Society of Automobile Engineers will hold its annual meeting in New York City on January 11 and 12, 1911, at the Automobile Club of America. The banquet will be held on Thursday evening at the club house.

BANQUET OF M. A. M.

The annual banquet of the Motor and Accessory Manufacturers will be held January 13 at the Waldorf-Astoria. The function will be the largest and most important of the annual banquets of this association.

New Features at the Olympia Show.

The great Olympia Show in London, so well described by Motor, was noteworthy for the new ideas, many of which ought to be interesting to those who are dabbling in motor car work. We briefly explain and partially illustrate what appears to be the most interesting.

The special feature of the Austrian-Daimler is its four-cylinder engine in which the valves are fitted directly into the cylinder engine, each pair of valves being set at 90 degrees to each other, and operated by a single, enclosed, overhead camshaft, which is

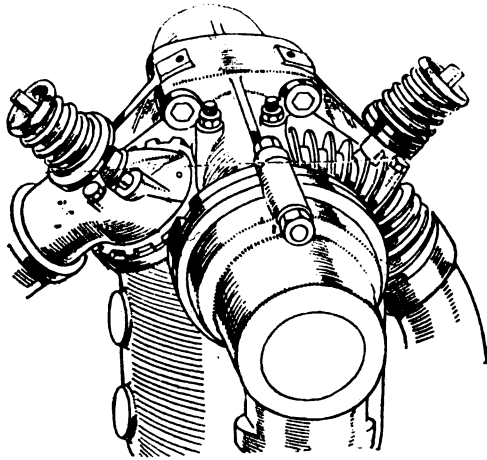

driven from the crankshaft through skew gearing and a vertical shaft. The most daring part of the design is that the valves are not water cooled. The valve seating is partially water cooled (it is in contact with a portion of the cylinder jacket); but the remainder of the valve housings is cooled only by radiation from a number of cast ribs.

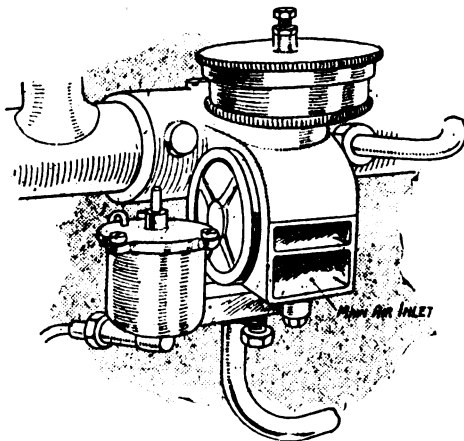

The Austrian-Daimler automatic carburetor as fitted to the Prince Henry Trophy type car.

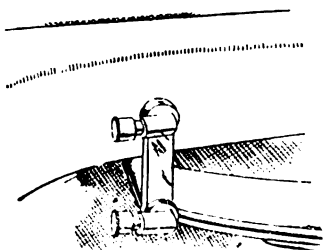

Arrangement of greasers for the spring shackle pins on the 15-18 H.P. Austrian-Daimler.

The Minerva-Knight car has the exhaust branches screened by air-jacketed sheet steel covers, not affected by heat.

Some of the attractive new ideas of the Lanchester car are illustrated below.

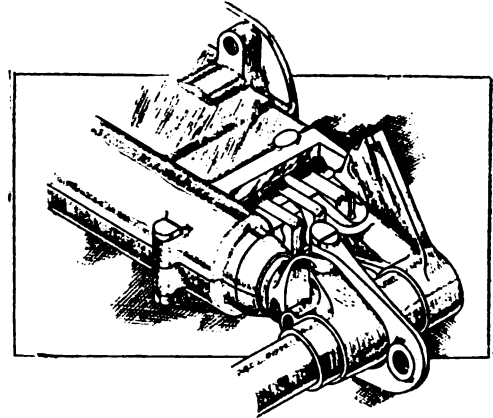

The Lanchester gear change and gate.

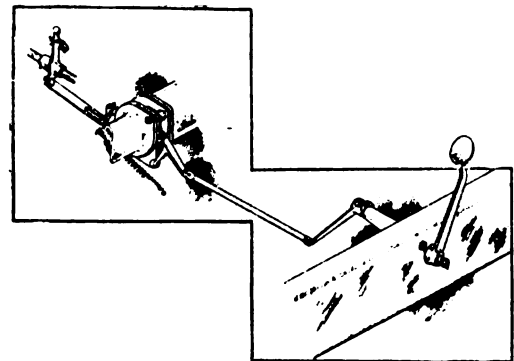

The arrangement of Lanchester throttle, showing alternative actuation by hand or foot.

The Dennis car was shown with leather hood attached to standard torpedo body. The hood meets a folding glass front placed behind the driver's seat. With windows fitted to side doors, a

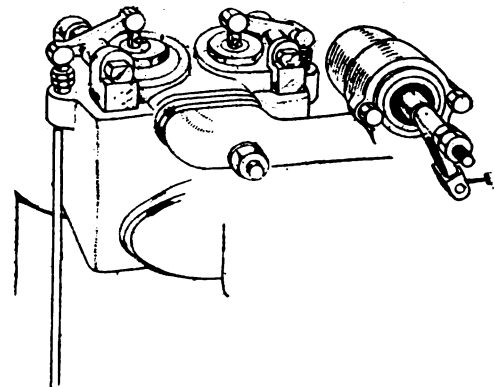

The new valve gear on the 15 H.P. Darracq.

draught proof back is had when desired, but when open, the ordinary touring body advantages are secured.

A landaulette body showed adjustable rear seats, to be made wider or narrower at will.

The Iris 15 h.p. is a very popular car, noted for compactness of design of engine. We show a couple of details.

The gate change lever of the Clement car is hinged at its base as shown and just above the forked part of the lever a vertical

hole is drilled. Into this the rounded ends of a stub lever is fitted, which stands up from the sliding shaft on which the select-

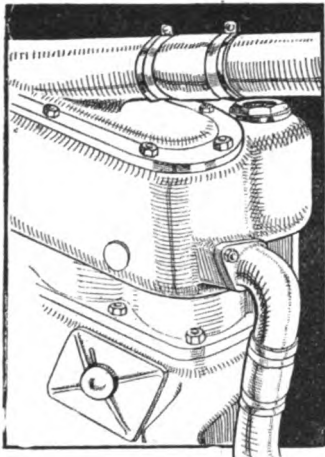

The 15 H.P. Iris engine is remarkably free from piping. The water is admitted at one end of the monobloc jacket and is internally directed to each of the cylinders.

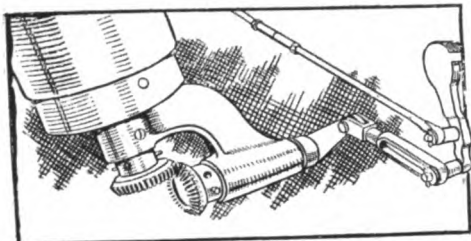

A workmanlike arrangement; the control gear on the 15 H.P. Iris. ing lever is secured. It makes side movement easy and no seizing in the bearings.

At the forward end of the camshaft and cast integral with the

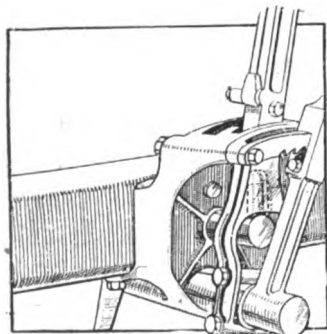

The Clement gate change lever is one of the few things that does not occasionally stick and make sideways movement a matter of difficulty.

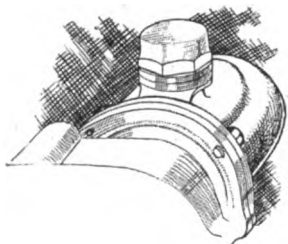

Commutator on vertical spindle at forward end of engine, 18-28 H.P. Clement. When not required bearing is covered with a cap.

half-time wheel cover is a pocket housing a pair of small wheels by which the vertical shaft may be driven from the camshaft.



New universal joint between flywheel and gearbox of 17 H.P. Maudslay car.

Morgan & Co. were the builders of a landaulette body for one of the Mardeslay cars which had victoria panels at the front seat, high side doors and an oyce in place of quarter panel at back. We show a few of the motor details.

The De Dietrich car is spoken of as a model of mechanical finish, and uncommonly silent running engine. We illustrate a new

arrangement of carburetor, showing a division into two parts—float chamber and jet, mixing chamber and throttle. The float is annular, with centrally arranged jet. The suction passage is con-

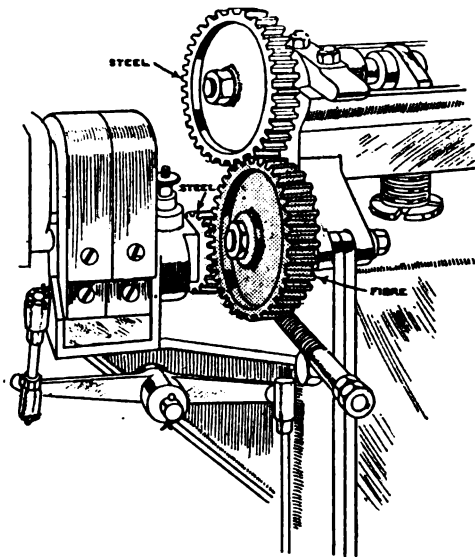

The magneto drive of the 17 H.P. Maudslay. nected to the mixing chamber by means of small copper pipe. The mixture drawn in being rich and diluted as required by travel

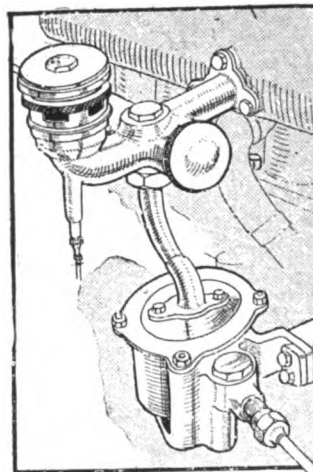

DeDietrich float chamber placed low in frame; the jet is central with the float, and a constant quality of gas is supplied thence to the mixing chamber.

conditions. The jet chamber is low, giving good head of gasoline, even when hill-climbing.

The steering gear has a sharp upward inclination towards the axle given to the fore and aft steering rod, which is supposed to steady the steering when at speed.

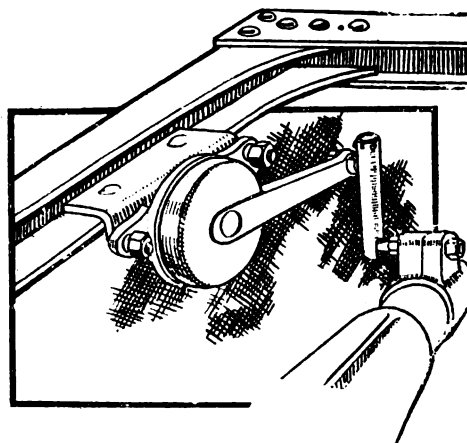

A novel position for the shock absorber adapted on the 18-20 H.P. de Dietrich. Sketch shows it secured to the rear cross member of the frame.

The Darracq is one of the noted French cars remarkable for the detail and ingenuity of its mechanical parts. A feature is the frame, sub-frame and undershelf in one piece.



Side brake, shaft, and compensating device on Lanchester cars.

The Humber, with its silent chain drive for camshafts and magneto was a noteworthy exhibit. It is a noise reducer of high quality. We show the idea below.

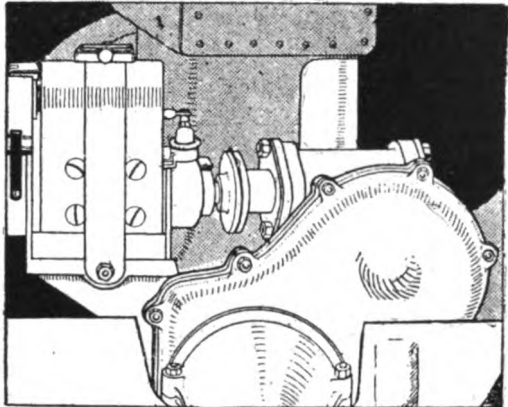

Chain-driven camshaft, magneto drive by spiral gearing, 1911 10 H.P. Humber.

A feature of the Perigeot is the side lever actuating two external shoe brakes at rear end of gear box. The method of closing these shoes together is illustrated.

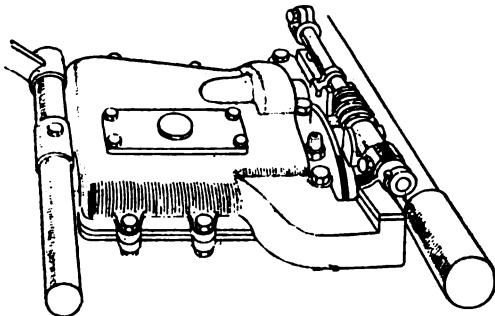

Double-acting cam brake actuating gear on the 10-12 H.P. Peugeot. Also a casting of merit.

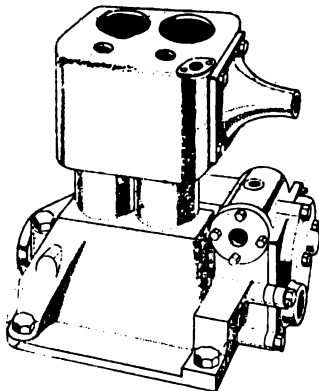

The twin-cylinder and crankcase casting of the 9 H.P. Peugeot engine.

The Sizaire cars are small ones, a single cylinder among them. We illustrate the improvements which are thus described. The steering centers have been improved, the sliding spindle carrying a cap which, extending downwards, covers the axle sleeve. A strong construction is thus obtained with larger bearing surfaces, which are well protected from wet and mud. The steering joints

are now provided with spring covers, so that the large ball joints can be easily lubricated. The long torque tube now carries a fork at its forward end, which is hinged to a transverse bar which

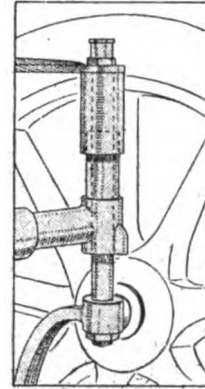

One of the steering centres of the Sizaire car showing protecting cap. carries the pedal for clutch and brake. Both brakes now act side by side on wide drums carried by the driving wheels. The foot brake is compensated by means of a pulley attached to the bar already mentioned, and round which the wire cable passes which operates the foot brakes. The hand brake acts through hollow rods through which the wires for the foot brake run, and by an ingenious double lever, carried by the axle casing both brakes are operated through short concentric shafts.

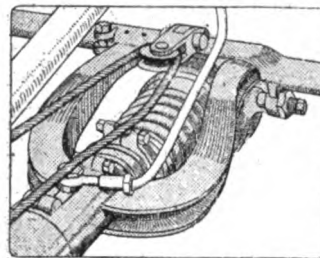

The forked forward end of the torque tube of the new Sizaire car.

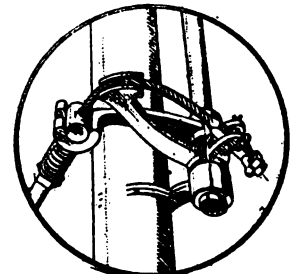

The brake compensating arrangement on the new Sizaire car.

The Wolseley car is of the worm-driven type. Those responsible for the design of the Wolseley cars have felt convinced that more room is available for the refining of motorcar mechanism than for the introduction of novelty merely for novelty's sake, and while prolonged life of the Wolseley chassis has always been aimed at, the additional aim is to secure prolonged silence throughout the mechanism. The result of a long series of experiments is that the timing gear of the engines (which, with the silencing of the valve gear, was commencing to be the most part of the gasoline motor)) has been so arranged that the peripheral

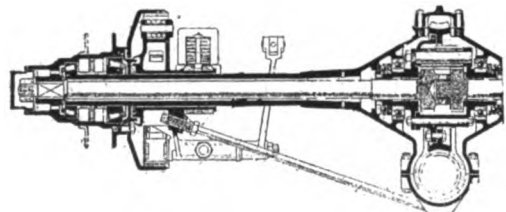

The Wolseley worm-driven back axle on the 12-16 H.P. car, showing Timken roller bearings.

speed of the wheels is materially reduced, an intermediate wheel permitting this to be done. With the employment of helical teeth, to the cutting of which considerable care is devoted, and with the employment of heavier crankcase castings, it has been found possible to make the timing gear almost silent.

A description of the single cylinder 8 h.p. DeDion car may prove interesting.

The new 8 h.p. single-cylinder is now made 90 mm. bore by 150 mm. stroke, in place of 100 mm. bore and the short stroke of 120 mm. in the previous single cylinder model of this horsepower.

It will no doubt be found that, with these modified dimensions, although considerably less in the bore, the engine will produce a superior power to the earlier types, and the results of the small car trials only go to prove the extraordinary gain which can, in some instances, be obtained by an increased stroke to bore ratio.

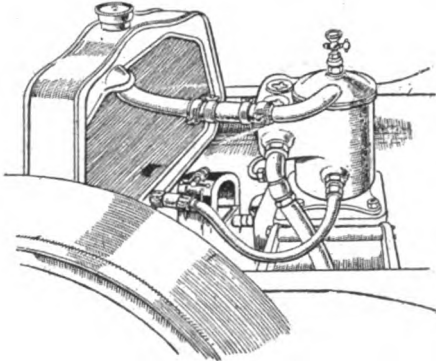

The 8 H.P. single cylinder DeDion engine showing the thermo-syphon pipes and direct-driven magneto.

One of the most interesting novelties of the DeDion cars is the modification of all clutch designs, and although the general features of last year's plate clutch are retained in the main, the plate of the new model is faced with a number of leather segments on either side, space being allowed between each segment for any creeping to which the leather may be subject in the course of usage.

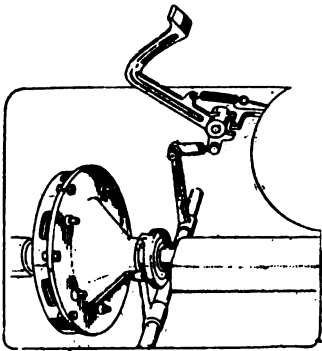

The plate clutch and its withdrawing mechanism on the 8 H.P. DeDion

It will be noticed that this clutch does not run in oil, and, although it is enclosed around the spring, the casing, which rotates with the engine shaft and against which one of the leather faces of the friction plate bears, has a large number of openings in its periphery, so that should any oil creep from the clutch bearings into the side of the clutch casing, it will not be harbored in the bottom of the said casing. The presence of these openings also enables one to inspect clutch leathers to a certain extent.

It will be noticed that an inside spring in compression is fitted on a sleeve which is an extension of the movable clutch plate. This plate is guided by a number of studs around its circumference, and rides on two short internal bronze bushes between its boss and the outside of the shaft, to which the friction plate is bolted. This friction plate shaft is, in turn, supported on a pair of bronze bushes riding on a long spigot extension of the engine shaft. The friction plate shaft is drilled partially up its centre under the spigot bearing and an oil hole leads from the circumference to the shaft, so that this spigot bearing can be efficiently lubricated. Declutching is performed by a curiously shaped ball bearing, consisting of two L-shaped rings fastening one another, the balls being retained between the angle of the two L's, and an outside retaining ring fitted with a screw plug for lubrication purposes, keeps these rings in place and prevents dirt from entering at this point. From the rear end of the friction plate shaft, the drive is transmitted to the gearbox shaft through a patent coupling, which allows a certain amount of sliding motion in addition to a slight change of angularity, the driving blocks being partially spherical at their points of contact with the driven blocks; a spherical form of grease retainer is fitted to this universal joint

which, incidentally, prevents any foreign matter finding its way in between the sliding faces.

The drive is by means of a live axle with De Dion patent radius rods. These rods are two in number, one attached to each end of axle, forming a triangle. Immediately above the front univer-

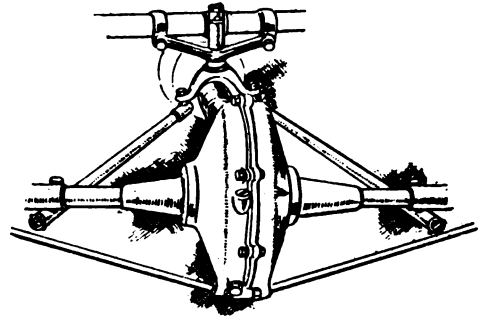

Rear view of the triangular arrangement of radius rod on the 8 H.P. and 9 H.P. DeDion.

sal joint of the propeller shaft is situated a cross member of the chassis, behind this is bolted a bracket with a vertical bearing. Into this a shank of cross head enters from below. To each end is bolted one of the radius rods.

The head is free to rotate about center spigot.

The oil filter of the New Engine cars is shown as something new. It is a nest of gauzes, so that if one becomes choked, the

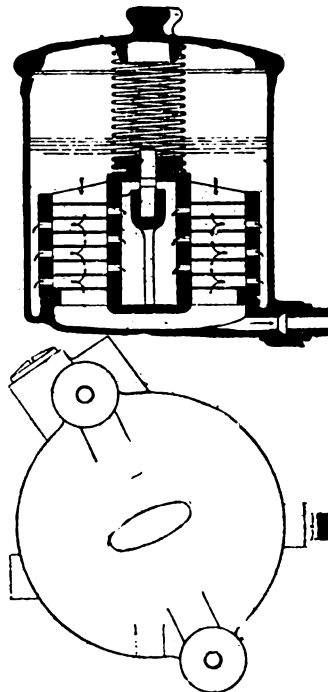

The oil filter in the lubrication system of the New Engine car. oil passes through the nest into the central portion, from which it is drawn by pump. There are seven gauzes.

The Napier models were the beauty spots of the show it seems, the bodies being in superb finish. The new change-speed gear is noteworthy. When on the high speed the layshaft is entirely idle, and not only does this give an increase in efficiency, and also render an appreciable degree of silence attainable, but beyond this there is the great advantage of easily changing into the second gear. A general idea of the mechanism is obtained from the illustration of the gearbox, while we hope that by means of the lettered diagram, we shall be able to make the operations of this new Napier gearbox easily understood. Looking at the illustration then, it is readily seen where the drive from the engine enters the gearbox by the primary shaft, and also whence it leaves for the back axle. The secondary shaft, which is fluted, is the upper one, the gearwheel to the right being fixed in position, the other two being slidable on the shaft. The drive to the layshaft on the indirect gears is through the medium of the pinion (A).

which meshes with the gearwheel (B). Therefore, as the other two gearwheels on the upper shaft are capable of being moved to the left or right and thus to see the operation of the second and the slow speeds respectively. For the top speed, A is moved away from B, and made to engage a segment annulus (groups of internal teeth) which is cut on the inside of the gearwheel (C). Thus, as there is nothing to drive the layshaft, it is obviously quite idle. Now for the crux of the arrangement—coming from the top speed to the second. First, of course, one declutches in the usual way, and when the control lever has released the gearwheel (A) from engagement with C, the clutch stop causes A to case rotating. Therefore, as A and B are both idle, it is obvious

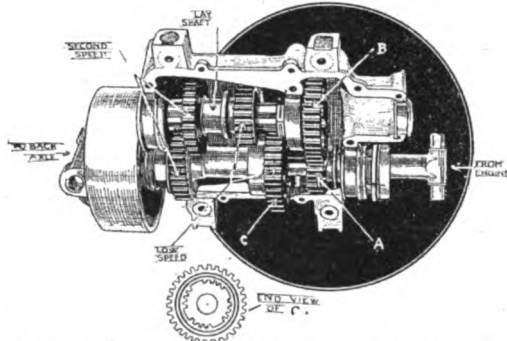

The new Napier top-speed idle layshaft gearbox. It is shown in this position for the sake of clearness.

that they can be easily re-engaged. The wheel (C), of course, is still running at the same speed as the tail shaft, this being possible on account of the ordinary spigot bearing, or "split" in the primary shaft. As we bring the gear lever from the top speed to the neutral position again, A and B are once more brought into engagement. Before engaging the second speed, however we momentarily allow the clutch to engage, and thus set the layshaft spinning, and it is arranged that the speed shall be very approximately the right one for easy engagement of the second speed gearwheel. Hence, it is seen that this change can now be effected in a remarkably simple and equally silent manner.

It is an ingenious idea, and it is carried out in an effective manner.

Like most of the exhibits, the aim to secure a noiseless working

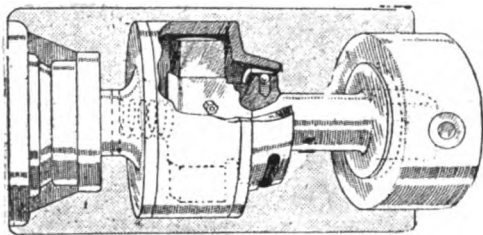

The improved Vauxhall coupling. Note the small cone clutch to prevent chattering when the main clutch is disengaged.

engine, is also shown in details of the Vauxhall car. The drive to the magneto is by rubber disc, giving a high degree of silence.

In the coupling shown of a metal to metal cone clutch, the

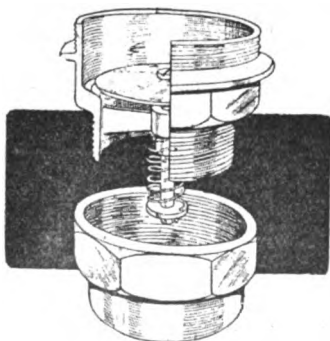

The ingenious pot-valve at the base of the Vauxhall sump. housing is engaged as main clutch is withdrawn, preventing much of the noise.

The pot valve here shown is automatic. Screwing the cap on

opens the valve by pressure against spring, allowing oil impurities to fall down into cap. Unscrewing the cap closes valve, so that impurities can be washed out with no leakage from engine.

There were many other features that will have attention at a future opportunity.

HOW WOULD IT LOOK?

Presume we should not ask a question that everyone will answer accordingly as he views the conceit. But we have often thought what a comical picture could be made if a buggy, for example, were to be tricked out with all the paraphernalia that is thought necessary to hang on or about a motor car. And why not? Both are vehicles. Both are used for identical purposes.

Let us take a look at this buggy. We would need a honk, horn at the rim of the leather dash. On the dash itself we should have one, perhaps, several, license tags. Over the wheels we would insist on dashes of the wing variety that would serve as a running board on which would be tool box and gas tank, because a buggy needs lamps, of course. A comparison of a buggy thus outfitted with a motor car as we are accustomed to view it would be truly comical, but why not? If needful on one outfit there should be reason for it on the other. Every vehicle that is licensed should or should not be tagged. All vehicles ought to be treated alike in the matter of license. An automobile at its stillest when in motion is much noisier than a horse-drawn vehicle, hence a warning should be sounded in one case as in the other.

Some day all the little absurdities will be resolved into a sensible general rule applicable to all vehicles alike. Just now we are being pleased with the toy and must have our fun.

TIMKEN AXLES AT AUTO SHOWS.

The Timken Roller Bearing Company, of Canton, O., will exhibit at both the Madison Square Garden Show in New York and the Chicago show, a full line of their various series of bearings:

Timken long series bearings, used principally for commercial car service.

Timken short series, used for pleasure car service.

Timken annular replacement series.

The latter series replaces, as far as physical dimensions go—the most commonly used sizes of annular ball bearings, and the demand for this series of bearings has been great, allowing, as they do, the replacement of annular bearings with Timken bearings, where wear has made the annular bearings subject to replacement.

A large truck bearing, which has been added to the Timken line, is their 940 bearing, which will be shown at both shows.

This bearing is made for wheel service on trucks of ten tons capacity and over. It is undoubtedly the largest capacity bearing produced by any one for this service.

RECEIVER FOR PARRY AUTO COMPANY.

The Parry Automobile Company, headed by D. M. Parry, was placed in a receiver's hands December 3, on the petition of a company having a claim of \$325. Parry says his company has \$200,000 invested and will reorganize.

WILL SELL AUTOS EXCLUSIVELY.

Cruzan & Co., of Des Moines, Ia., will retire from the implement trade for the purpose of devoting their energies exclusively to the sale of automobiles. The company has been identified with the implement and vehicle business in Des Moines for the past sixteen years.

The annual dinner of the Automobile Trade Credit Association of New York will be held January 18. Members will be allowed to invite friends.

MATHESON COMPANY REORGANIZED.

By an order of the court the Matheson Automobile Company has been permanently taken out of the hands of its receivers and given over to the company, which has been reorganized with largely increased capital. At the first stockholders' meeting of the reorganized company the following directors were elected: W. C. Shepherd, president and general manager; J. W. Hollenback, vice-president; E. F. Matheson, secretary; Henry H. Pease, treasurer. C. W. Matheson is also a director.

The paid-in cash capital of the Matheson Motor Car Company was \$350,000 and the bond issue \$200,000. The paid-in cash capital of the Matheson Automobile Company, which was the New York selling company, was \$150,000. Now \$700,000 new money has been added to the reorganized company in the form of \$595,000 first preferred stock issued and \$105,000 bonds issue. The new money gives the reorganized company a paid-in cash capital of \$1,100,000 plus the bond issue of \$300,000, which makes this company financially one of the strongest concerns in this country engaged in the exclusive manufacture of high-powered, high-grade motor cars. The authorized stock and bond issues of the company are \$1,000,000 first preferred stock, \$400,000 second preferred stock, \$1,250,000 common stock, and \$300,000 bonds.

The new company begins under favorable conditions, and the future promises a splendid success for the business.

RETIREES FROM PRESIDENCY.

The recent retirement of John W. Stoddard from the presidency of the Stoddard-Dayton Motor Co., manufacturers of the Stoddard-Dayton cars, was marked by the presentation of a bronze tablet by the 2,200 men employed in the great shops in Dayton, Ohio. The incident in Mr. Stoddard's business career from 1872 to 1910 was represented by the products of his business in bold bas relief on the huge tablet. This voluntary expression of the esteem in which he is held by the men of shops was a surprise to Mr. Stoddard, as well as to the department heads, the idea having been conceived and carried out entirely by the shop workers. The inscription emphasized their appreciation of Mr. Stoddard as a considerate employer.

REO BUYS THE OWEN.

The Owen Motor Car Co., of Detroit, has been formally absorbed by the Reo Motor Car Co., of Lansing, Mich., and henceforth the Owen car which is to be rechristened the "R-O," will be built in Lansing, where it will occupy a part of the new Reo truck plant. While the amalgamation entailed an exchange of Owen shares for Reo shares, the basis of exchange has not been permitted to become public. Ralph M. Owen, the president of the Owen company and the designer of its car, who is a brother of Ray M. Owen, the Reo distributor, and F. R. Bump, sales manager of the Reo Company, both have joined the Reo organization.

AMERICAN FEDERATION TAKES IN AEROPLANE INDUSTRY.

The American Federation of Labor has taken cognizance of the aeroplane industry by adopting a resolution, changing the name "carriage and wagon workers" to "carriage, wagon, automobile and aeroplane workers international union of America," and amending the charter of that body to conform with this.

ELECTRIC VEHICLE MEN MEET.

The first regular monthly meeting of the newly formed Electric Vehicle Association of America was held in New York City, November 29. C. L. Morgan made an address on the essentials of operation and care of commercial trucks. He advocated more care in inspection and periodic overhauling. The society has a membership of 250.

WE SUPPOSED THERE WERE MORE.

We have read that the autos circulating in agglomeration of places called Berlin, such as Charlottenberg, Schoeneberg, Rixdorf and Lichtenberg, there are, all counted, some 6,133 motor cars of all classes. The item continues that these comprise an eighth part of all the motor cars in use in Germany.

This would make the total in use about 49,000. How strange it sounds to us to be told that there only half a hundred thousand cars in Germany. How strange it must sound to the Germans to read that merely one of our factories can claim that output, and not be thought to be anything to stare at as a producer.

And to think that merely one Cincinnati buggy factory could replace all the motor cars in Germany with its year's output. This is a great country when considered on a quantity basis.

MR. HODGE HONORED.

H. J. Hodge, of Abilene, Kan., secretary of the National Federation of Retail Implement and Vehicle Dealers' Associations, has been appointed by Governor Stubbs delegate to the Trans-Mississippi Commercial Congress, now in session at San Antonio, Texas.

FOLLOWING THE TIMBER LINE.

The Dalton Hub and Spoke Factory has moved to Macon, Ga. The plant was installed some time ago for the purpose of sawing up timber for the main factory in Tennessee. The scarcity of timber required caused the removal from Dalton, Tenn., to Macon.

CHANGE IN THE ZIEGLER-SCHREYER CO.

W. T. Rawleigh has purchased a controlling interest in the Ziegler-Schreyer Company, of Freeport, Ill. He has bought the holdings of O. J. Ziegler, Roy Bennethum and Louis Hughes. Messrs. Zeigler and Bennethum will retire from the company and Mr. Hughes will be retained on the office force.

Wants

Help and situation wanted advertisements, one cent a word; all other advertisements in this department, 5 cents a word. Initials and figures count as words. Minimum price, 30 cents for each advertisement.

POSITION WANTED.

Position Wanted—Carriage painter wishes job in small custom shop, to take charge; is all round man, stripper and finisher. Address W. A. R., care The Hub, 24 Murray St. New York City

HELP WANTED.

Wanted—Experienced foreman painter; a man who has had experience and is capable of handling men and getting through a large amount of work in the body and seat department. Address Freeport Carriage Co., Freeport, Ill.

Wanted—A young man with some experience in the light vehicle business as salesman for wheel factory. When not on the road selling wheels to put in his time in the office. State age, experience and give references. Address R. B. C., care The Hub, 24 Murray Street, New York City.

FOR SALE.

For Sale—Carriage and blacksmith business in town of 15,000 population. New two story, up-to-date, concrete block shop, 30x50, all the latest machinery, electric power, trip hammer, planer, band saw, lathes, drill, press, etc. Two lots, 25x125, and four room house. Good business, am selling on account of accident which renders me unfit for work. Address R. J., care The Hub, 24 Murray Street, New York City.

PATENTS.

Patents—H. W. T. Jenner, patent attorney and mechanical expert, 608 F St., Washington, D. C. Established 1883. I make a free examination and report if a patent can be had and exactly what it will cost. Send for circular.

The TIMKEN ROLLER BEARING CO.

MAKERS OF TIMKEN ROLLER BEARING AXLES
for WAGONS and CARRIAGES

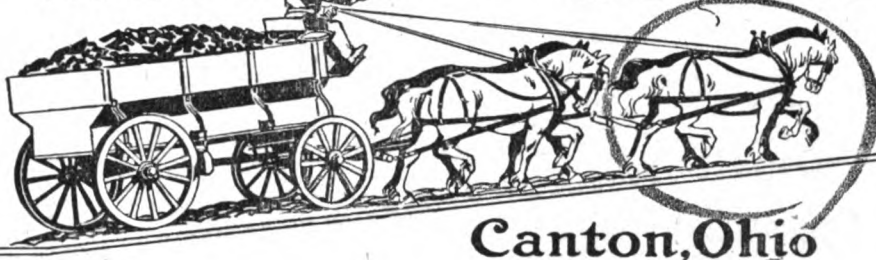

Canton, Ohio

A Set of
TIMKEN AXLES
will save your
CUSTOMERS
these two horses

This statement is based on the experience of thousands of users.

New Catalog and Price List upon application.

THE TIMKEN ROLLER BEARING CO.,
CANTON, OHIO,

BRANCHES- 10 E. 31 st Street, New York.
429 Wabash Avenue, Chicago.

HANDY LAMP GASOLINE LIGHTING SYSTEM

Draws Trade to Your Shop.

Gives a 300 Candle Power Shadowless Light the instant you move the lever. Turns up or down, like gas, burns dim when not in use, or can be turned up instantly when more light is needed. It floods a 30-foot space with a brilliancy like daylight. Far cheaper than gas, kerosene or electricity, and so simple that anyone can use it. You can depend on it for years for any purpose demanding a big, strong light. Catalogue H tells why: Send for it now.



BRILLIANT GAS LAMP CO.

DEPT. 29. 42 STATE ST. CHICAGO, ILL.

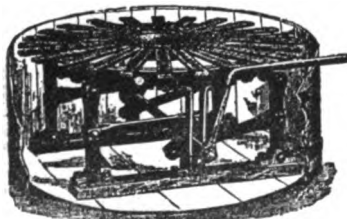

The Bokop Tire Setter and Cooler is the Best and Only Machine that has stood the test during the last 12 years on all classes of work, and is the Only Machine built with the Indestructible Wrought Iron Face Plate. Over 1,000 are in successful operation, repairs on which have not exceeded \$6.00 in the last 12 years. For prices, references and descriptive circulars, address **BOKOP, WEBB & PALM,** Defiance, Ohio

E. SCOTT PAYNE Co.
OF BALTIMORE CITY
CARRIAGE AND AUTOMOBILE
HARDWARE

362 and 364 North Gay Street, BALTIMORE, MD.

CARRIAGE SPRINGS OF EVERY STYLE AND PAT- TERN TO ORDER

Also Curtain Rollers and Concealed Hinges

EXCLUSIVELY FIRST-CLASS WORK

THE BEST THAT CAN BE MADE

SPRING PERCH CO.

BRIDGEPORT, CONN.

Please mention "The Hub" when you write.

HOTEL CUMBERLAND

NEW YORK

Southwest Cor. Broadway at Fifty-fourth St
Near 50th St. Subway Station, 53d St. Elevated and all Surface Lines.



Headquarters for Carriage and Automobile Trade

Ideal Location, Near Theatres,
Shops and Central Park.

**NEW AND FIREPROOF
STRICTLY FIRST-CLASS**

RATES REASONABLE
All Hardwood Floors and
Oriental Rugs.

Ten Minutes Walk to
Twenty Theatres.

Transient Rates, **\$2.50** with Bath, and up.
Excellent Restaurant. Prices Moderate.
SEND FOR BOOKLET.

HARRY P. STIMSON, Formerly with Hotel Imperial.
R. J. BINGHAM, Formerly with Hotel Woodward.



A. OCHSNER & SONS CO.

NEW HAVEN, CONN.

Auto and Carriage Locks, Hinges, Etc.

VEHICLE AND AUTO TOP HARDWARE
Rails, Joints, Bow Sockets for the
WHOLESALE TRADE ONLY

Write
INDIANA FORGING COMPANY.
Mention Hub. **INDIANAPOLIS, IND.**

ESTABLISHED 1886.

Correspondence School of Carriage and Motor Carriage Drafting

A thorough, practical tuition is given through this correspondence school. The theory and practice of construction, bookkeeping, perspective. Many men now hold good positions through taking the courses of instruction.

Principal, THOS. MATTISON,
Hillside Avenue, Bitterne Park,
Southampton, England.

Author of "The Coach Body Makers' Guide," \$3.00; a practical treatise on "The Suspension of Carriages," "Bookkeeping," and other carriage building works.

INDEX TO ADVERTISEMENTS.

| | |
|------------------------------------------------|-----------|
| A. L. A. M. Show | 4 |
| American Ball Bearing Co., The | 2nd cover |
| American Roller Bearing Fifth Wheel Co. | 18 |
| Ault & Wiborg Co., The | 3 |
| Bailey & Co., Inc., S. R. | 18 |
| Bokop, Webb & Palm | 11 |
| Bennett Mfg. Co. | 3 |
| Brilliant Gas Lamp Co. | 11 |
| Boub Wheel Co., H., The | 18 |
| Cately & Ettlmg | 2 |
| Columbus Bolt Works | 4th cover |
| Consolidated Rubber Tire Co. | 1 |
| Crane & MacMahon | 2nd cover |
| Devoe, F. W., & Reynolds Co., C. T. | 3rd cover |
| Eberly & Orris Mfg. Co. | 3rd cover |
| Eccles Co., Richard | 17 |
| Frantz Body Mfg. Co., The | 3 |
| Gifford & Son, John A. | 11 |
| Goodrich Co., B. F., The | 5 |
| Goshen Eyelet Co. | 14 |
| Gramm Motor Car Co., The | 3 |
| Higgin Mfg. Co. | 13 |
| Hoopes Bro. & Darlington, Inc. | 2nd cover |
| Indianapolis Dash Co. | 2 |
| Indiana Forging Co. | 12 |
| Jones & Co., Phineas | 6 |
| Keystone Paint & Filler Co. | 4 |
| Keystone Spring Works | 13 |
| Kilvington, S. W. | 18 |
| Kimble, Andrew | 4 |
| Masury & Son, John W. | 2 |
| McKinnon Dash Co. | 4th cover |
| Mercer, Geo. J. | 18 |
| Moller & Schuman Co. | 6 |
| Mott Wheel Works | 3rd cover |
| Murphy Varnish Co. | — |
| National Aluminum & Bronze Co. | 3rd cover |
| Nelson, Co., A. T. A., | 1 |
| New Wapakoneta Wheel Co., The | 4th cover |
| Ochsner & Sons Co., A. | 12 |
| Payne Co., E. Scott | 11 |
| Porter, H. K. | 17 |
| Reilly, John, Inc. | 1 |
| Russell, Burdsall & Ward Bolt and Nut Co. | 3rd cover |
| Schubert Bros. Gear Co. | 17 |
| Shortsville Wheel Co. | 13 |
| Smith & Co., Edw. | 6 |
| Spring Perch Co. | 11 |
| Standard Oil Cloth Co. | 18 |
| Standard Wheel Co. | 17 |
| Timken Roller Bearing Co. | 11 |
| Uebelmesser Co., Charles R. | 14 |
| Valentine & Company | 6 |
| West Tire Setter Co. | 2 |
| Wilcox Mfg. Co., D. | 15 |
| Wiley Co., C. A. | 4 |
| Woodman, Joel H. | 14 |

Please mention "The Hub" when you write.

The HIGGIN Line of Carriage Trimmings

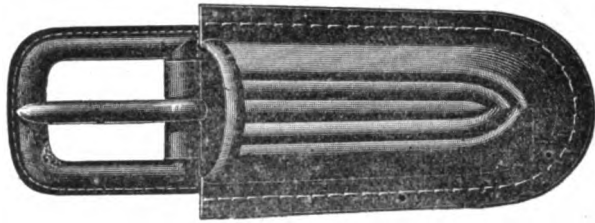

No. 8.—Leather Buckle Loop.



No. 70.



No. 74.



No. 72.

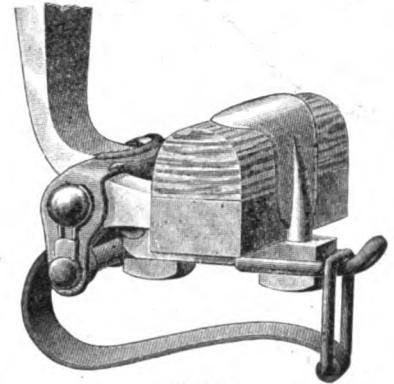

Closed
The Higgin Quick Shifter.



No. 13—Black Japan Nut.



Full Leather.



No. 130
KNOBS FOR ALL PURPOSES.



No. 133

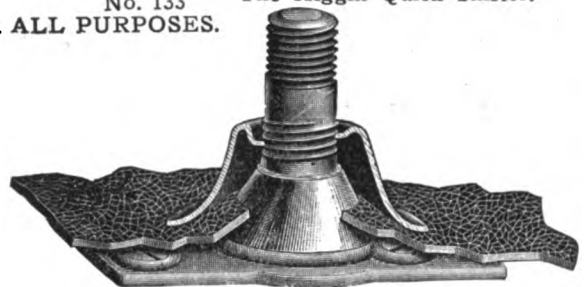

Wrought Steel Prop.

QUALITY UNSURPASSED

Send for catalogue and get acquainted with our line.

THE HIGGIN MANUFACTURING CO.

NEWPORT, Ky.

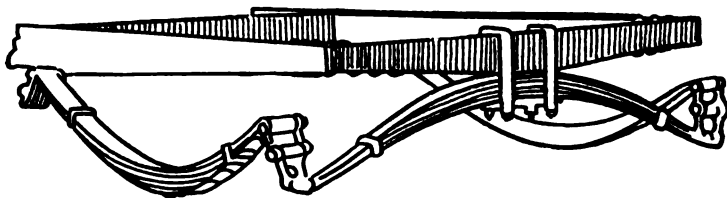

Automobile Wagon and Truck **SPRINGS**

KEYSTONE SPRING WORKS, Inc.

1301-11 Buttonwood Street

PHILADELPHIA, PA

EXAMINE CAREFULLY

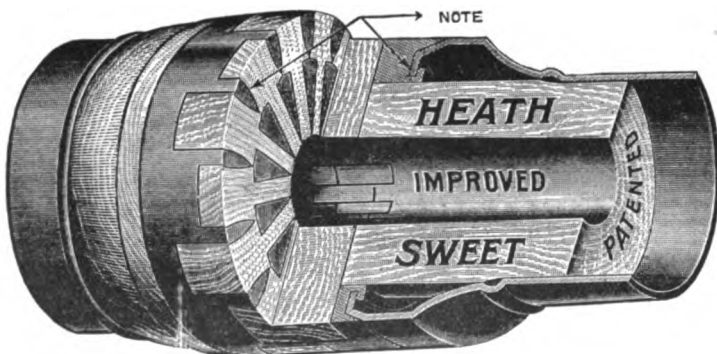

HEATH HUB

You Won't Find a Flaw

Manufacture also

SWEET
SARVEN

KENNEY
SHELL

WARNER
OOD

and

AUTOMOBILE WHEELS

Shortsville Wheel Co.,

Shortsville, New York

Please mention "The Hub" when you write.



Painters and Decorators Save Time, Labor and Money, using the

Uebelmesser Striping and Stencil Wheel

With this simple, clean and rapid-action tool the most ordinary decorator can do the finest striping and stencil work and produce a bigger day's work with less labor than by the old fashioned method. Complete directions are furnished with each tool. They are as simple as the tool itself.

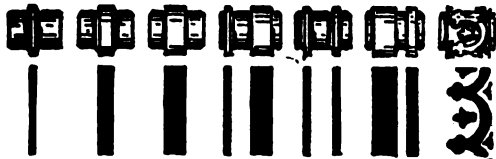

Just a few of the many designs that can be produced with the Uebelmesser Painters' and Decorators' Tool. (The designs shown above are reduced in size)

Complete Outfit consisting of Machine, 10 Plain and 10 Ornamental Wheels, only **\$5.50**

LIBERAL DISCOUNT TO THE TRADE

Manufactured by

Charles R. Uebelmesser Company
Bayside, New York, N. Y.

Advertisements Classified

The following list includes advertisers in THE HUB. Each advertiser is entitled to name under one heading only. An extra charge for name under more than one heading.

Axles, Etc.

- American Ball Bearing Co., Cleveland, Ohio.
- Keagy & Lear Machine Co., Coshocton, Ohio.
- Timken Roller Bearing Co., Canton, Ohio.

Bodies, Seats, Etc.

- Frants Body Mfg. Co., The Akron, Ohio.
- Kilvington, S. W. Wilmington, Del.
- Woodman, Joel H., Hoboken, New Jersey.

Bolts and Nuts.

- Columbus Bolt Works, Columbus, Ohio.
- Russell, Burdell & Ward Bolt and Nut Co., Port Chester, N. Y.

Carriage Forgings.

- Columbus Bolt Works, Columbus, Ohio.
- Eccles Co., Richard, Auburn, N. Y.
- Indiana Forging Co., Indianapolis, Ind.

Carriage Hardware.

- Cately & Ettling, Cortland, NY
- Cleveland Hardware Co., The, Cleveland, Ohio.
- Eberhard Mfg. Co., The, Cleveland, Ohio.
- Gifford & Son, John A., New York.
- Ochsner & Sons Co., A., New Haven, Conn.
- Payne Co., E. Scott, Baltimore, Md.

Carriage Goods.

- Gifford & Son, John A., New York.
- Higgin Mfg. Co., Newport, Ky.

Dashes, Fenders, Ralls, Etc.

- Bennett Mfg. Co., Aiden, N.Y.
- Indianapolis Dash Co., Indianapolis, Ind.
- McKinnon Dash Co., Buffalo, N. Y.

Fifth Wheels.

- American Roller Bearing Fifth Wheel Co., Brooklyn, N. Y.
- Wilcox Mfg. Co., D., Mechanicsburg, Pa.

Finished Vehicles.

- Bailey & Co., Inc., S. R. Amesbury, Mass.

Gear Irons

- Wilcox Mfg. Co., D., Mechanicsburg, Pa.

Gear Woods.

- Andrew Kimble, Zanesville, O.

Lamps.

- Brilliant Gas Lamp Co., Chicago, Ill.
- Gifford & Son, John A., New York.

Leather.

- Nelson, A. T. A., Co., Cincinnati, Ohio.
- Reilly, John, Inc., Newark, N.J.

Motor Trucks.

- Gramm Motor Car Co., The Bowling Green, O.

Machinery and Tools.

- Bokop, Webb & Palm, Defiance, Ohio.
- Porter, H. K., Everett, Mass.
- West Tire Setter Co., Rochester, N. Y.

Miscellaneous.

- Goshen Eyelet Co., Goshen, Ind.
- National Aluminum & Bronze Co., Indianapolis, Ind.
- Standard Oil Cloth Co., New York.
- Uebelmesser Co., Charles R. Bayside, New York, N. Y.

Rubber Tires.

- Consolidated Rubber Tire Co., New York City.
- Goodrich Co., B. F., Akron, O.

Shaft Couplings and Anti-Rattlers.

- Eccles Co., Richard, Auburn, N. Y.

Metal Stamping Co., New York City.

Springs and Gears.

- Keystone Spring Works, Inc., Philadelphia, Pa.
- Spring Perch Co., Bridgeport, Conn.

Varnishes, Paints and Japans.

- The Nutt & Wiborg Co., Cincinnati, Ohio.
- Devos, F. W., and C. T. Reynolds Co., New York City.
- Masury & Son, John W., New York and Chicago.
- Moller & Schumann, Brooklyn, N. Y.
- Murphy Varnish Co., Newark N. J.
- Smith & Co., Edw., New York.
- Valentine & Co., New York, Chicago, Boston, Paris.
- Willey Co., C. A., Hunter's Point, New York City.

Wheels.

- Crane & MacMahon, New York.
- Eureka Bending & Wheel Co., The, York, Pa.
- Gifford & Son, John A., New York.
- Hoopes Bro. & Darlington, West Chester, Pa.
- Jones & Co., Phineas, Newark, N. J.
- New Wapakoneta Wheel Co., Wapakoneta, Ohio.
- Shortsville Wheel Co., Shortsville, N. Y.
- Standard Wheel Co., Terre Haute, Ind.

Wheel Stock, Bent Wood, Etc.

- Crane & MacMahon, New York.

White Lead.

- Eagle White Lead Co., Cincinnati, Ohio.

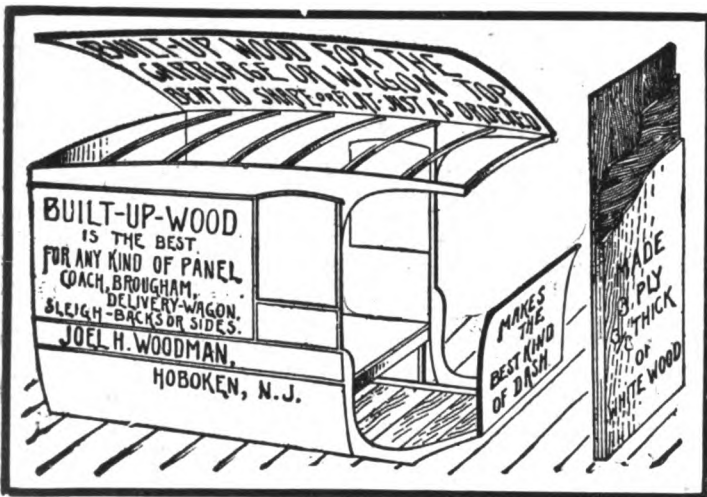

Goshen Eyelet Co.

Manufacturers of

Carriage Top Trimmings

GOSHEN, INDIANA

HEADQUARTERS FOR SPECIAL

FINE GEAR IRONS [Drop Forged] CARRIAGE HARDWARE

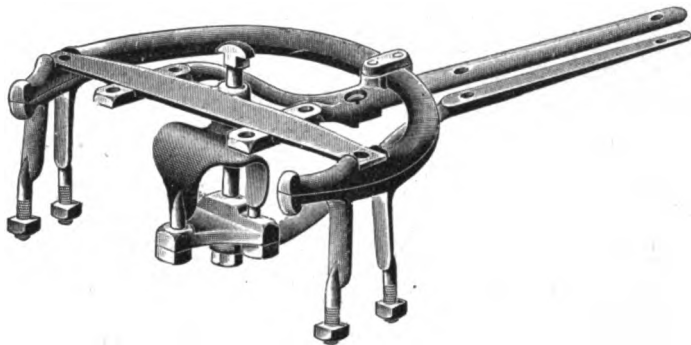

No. 1908—Gear Iron

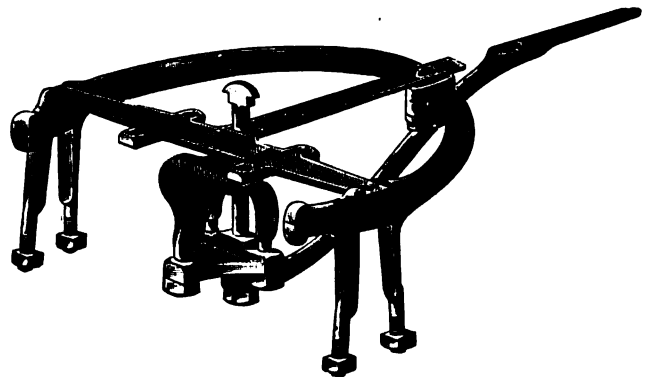

No. 2000—Gear Iron

WILCOX'S Mechanical 3 Prong King Bolt

Double Locked in Head Block
Plate and King Bolt Yoke. No
Strain on Bolt. No Turn on
Nut. Guaranteed.

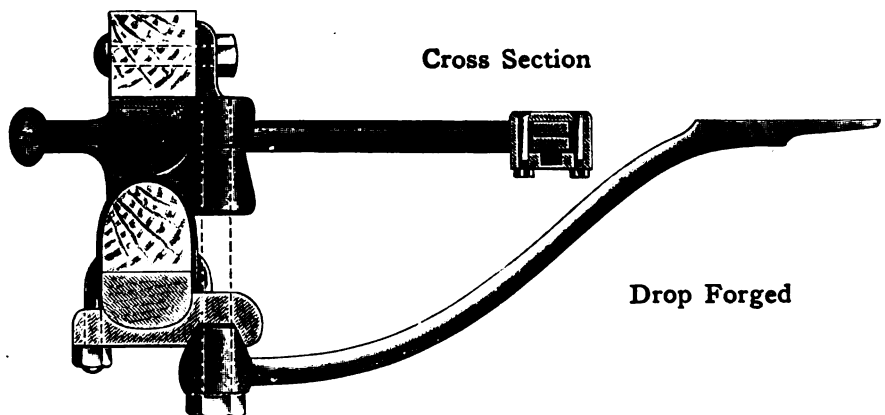

Cross Section

Drop Forged

Patented

S
U
R
E

S
A
F
E

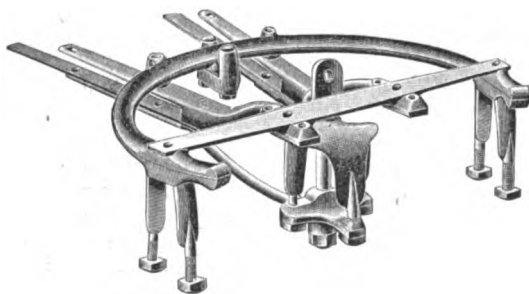

No. 1905—Gear Iron

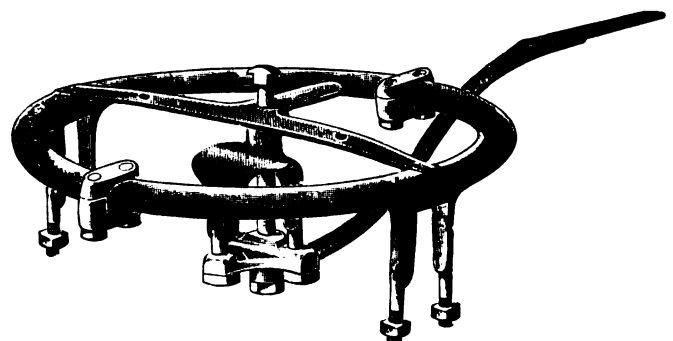

No. 1909—Concord

Forget your trouble and decide at once to use WILCOX DROP
FORGED IRONS. Write us for pleasure

The D. Wilcox Mfg. Co. Mechanicsburg Pa.

Please mention "The Hub" when you write.

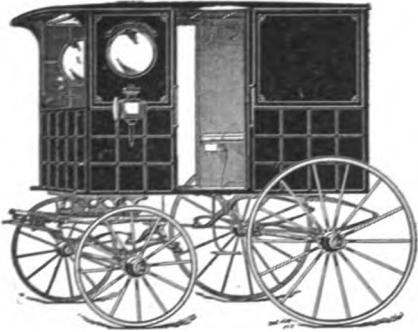

No. 112.—Milk Wagon.

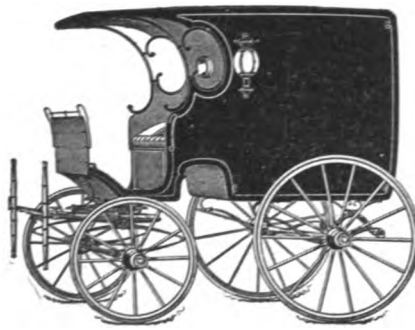

No. 111.—Altman Wagon.

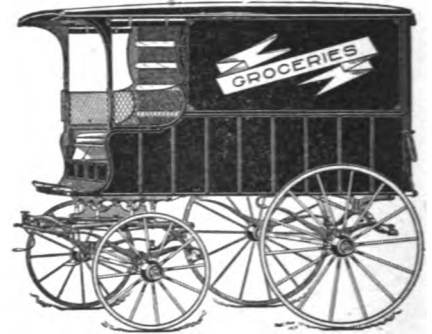

No. 113.—Grocery Wagon.

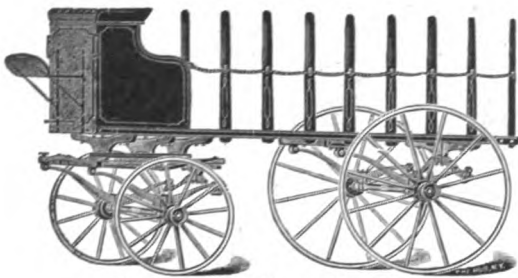

No. 122.—Flour Truck.

Electrotypes

of the vehicles presented on this page will be forwarded on receipt of

75 cts.

for each cut, to any address. Postage prepaid.

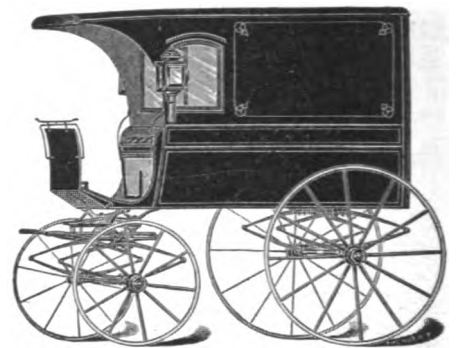

No. 115.—Delivery Wagon.

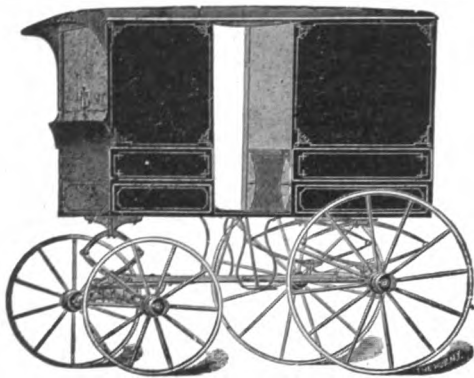

No. 116.—Milk Wagon.

Catalogue

containing nearly 200 illustrations of carriages, wagons, sleighs, and miscellaneous cuts will be sent upon application.

Trade News Publishing Co.
24-26 MURRAY ST.
NEW YORK

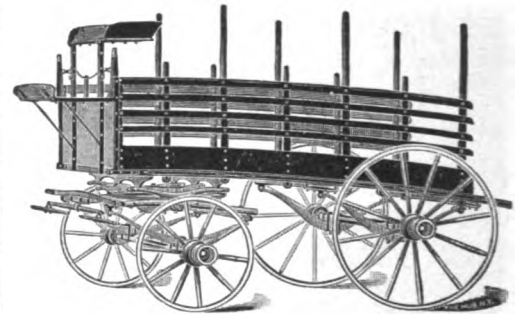

No. 117.—Merchandise Truck.



No. 114.—Delivery Wagon.

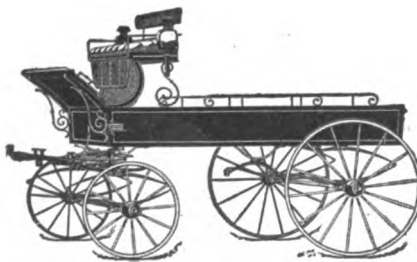

No. 124.—Delivery Wagon.

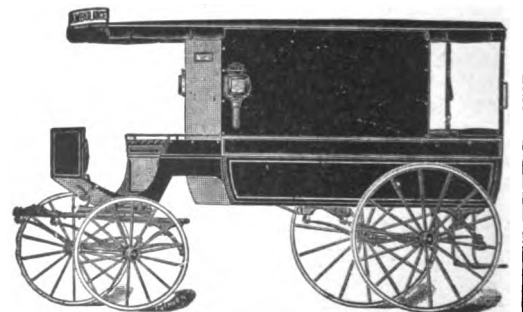

No. 118.—Ambulance.

Please mention "The Hub" when you write.

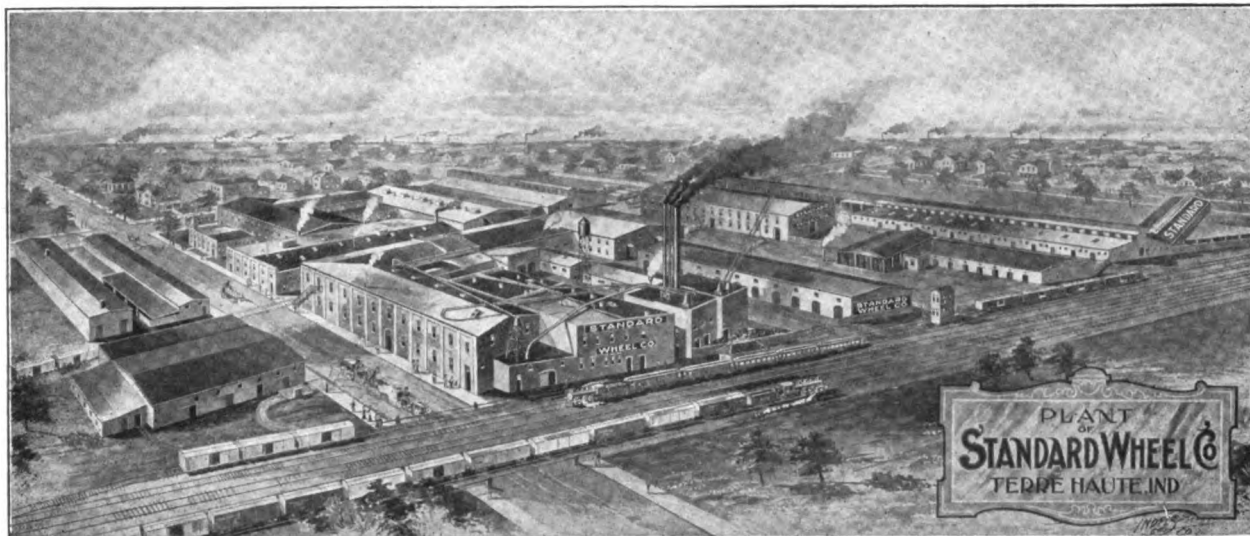

VEHICLE WHEELS AND WHEEL MATERIAL

Three Separate Departments [Light Carriage and Buggy Wheels
Heavy Express Wagon and Truck Wheels
Automobile Wheels

OUR GRADES ARE UNEXCELLED

WRITE FOR LIST.

Terre Haute, Ind. **STANDARD WHEEL CO.** Terre Haute, Ind

Richard Eccles Co., Auburn N. Y.

Manufacturers of

Forgings: Carriage, Wagon, Automobile, Special

Send for Catalogue.



Carriage Mechanics

Desiring to improve their present Condition should attend the

TECHNICAL SCHOOL

FOR

Carriage Draftsmen and Mechanics

SUPPORTED BY THE

Carriage Builders' National Ass'n.

The object of the School is to teach men to design vehicles and make working drawings, and to otherwise facilitate their work in the shop. Only those men employed in carriage or automobile building or their accessory trades are admitted to its privileges.

The classes are conducted in three divisions, viz.: Corresponding, Day, and Evening. The former is open during the entire year, while the day and evening classes are in session only from October 1st to April 1st.

The tuition is moderate.

For prospectus and full particulars, write to the instructor,

ANDREW F. JOHNSON,

18 West Forty-fourth St.,

NEW YORK CITY.

VEHICLES AND GEARS IN THE WHITE



PREMIER SIDE SPRING GEAR

We manufacture a full line of Carriage and Wagon bodies in the white; also Limousine, Taxicab, Touring Car and Roadster Bodies for automobiles in metal. Fifty styles of gears for Carriages and Wagons; also seats, trimmings and tops of all kinds.

Write to us for particulars.

Schubert Bros. Gear Company

ONEIDA, NEW YORK.

Please mention "The Hub" when you write.

F. W. DEVOE & C. T. RAYNOLDS CO.

101 and 103 FULTON STREET, NEW YORK

Manufacturers of

F. W. DEVOE & CO'S {
COACH COLORS
VARNISHES
BRUSHES
SPECIALTIES

C. T. RAYNOLDS & CO'S {
COACH COLORS
VARNISHES
BRUSHES
SPECIALTIES

FOR PAINTERS, ARTISTS AND DECORATORS

All the brands and specialties of F. W. Devoe & Co. and C. T. Raynolds & Co. will be maintained separately as heretofore.

WIRE WHEELS TO FIT EMPIRE BALL BEARING AXLES

Quality Unsurpassed

Write Today

The Mott Wheel Works
UTICA, N. Y.

What is a Brake ?

Is it an article that stops your vehicle when needed, and the same time ruins your rubber tires, or is it something that rolls against the tires, protecting them, but not stopping the vehicle? No, these cannot be called brakes. A brake is an article that WILL STOP the vehicle, WITHOUT RUINING the tires.

Is there such an article on the market? Yes, the DAVIS FRICTION METAL ROLLER BRAKES are the only brakes on the market that embrace these qualities, along with many other qualities, beneficial to all rubber tire vehicles.

The DAVIS brakes can be immediately placed on any vehicle equipped with or for the old brakes, by simply removing the old shoes, blocks, or rollers, and squaring the ends to fit the DAVIS.

For prices and further information write to the
NATIONAL ALUMINUM & BRONZE CO.
SOLE MANUFACTURERS.
INDIANAPOLIS, INDIANA
Will exhibit at C.B.N.A., National Vehicle and Tri-State Shows.



BOLTS Rivets, Carriage Makers' Washers
and Burrs for all kinds of Vehicles
Russell, Burdsall & Ward Bolt and Nut Co.

Main Works, PORT CHESTER, N. Y.

Branch at Rock Falls, Ill.

Time Has Told the Story!

Service and satisfaction always follow our rolling stock

WHEELS

ALL KINDS—BEST QUALITY

Also RIMS and SPOKES

The Eberly & Orris Mfg. Co.
MECHANICSBURG, PA.

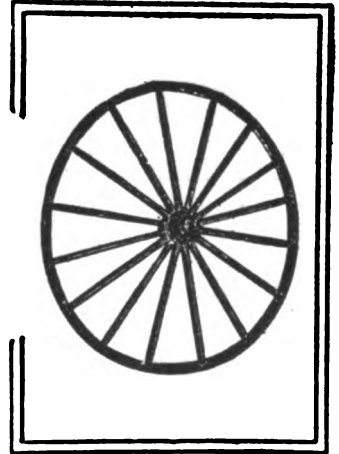
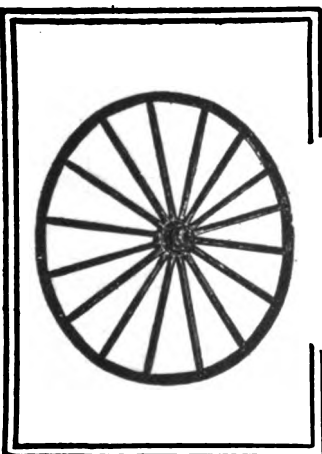

McKINNON DASH COMPANY

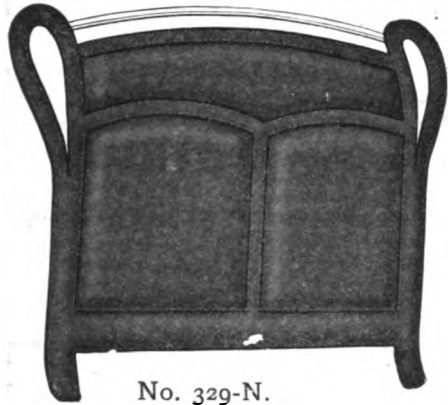

No. 329-N.

BUFFALO, N. Y.

**TROY, OHIO,
CINCINNATI, OHIO.**

**ST. CATHARINES,
ONTARIO.**

Our No. 329 N, with nickel rail
is one of our new designs
for 1911
The rail insures the life of the dash

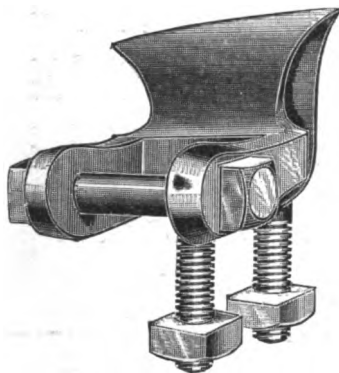

Skewed Shaft Couplings

**Regular or Oval Patterns
For High Arched Axles**

Furnished in rights and lefts for any height of arch. Oval Axle
Clips $\frac{3}{8}$ or $\frac{1}{4}$ width to match Oval Couplings. Bolts, Clips,
Couplings, Carriage Hardware and Special Forgings

Catalogue "H" and Prices on Application.

COLUMBUS BOLT WORKS, Columbus, O.

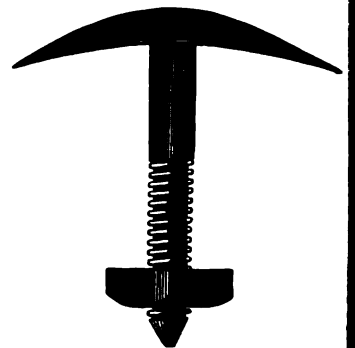

VEHICLE WHEELS OF REAL WORTH

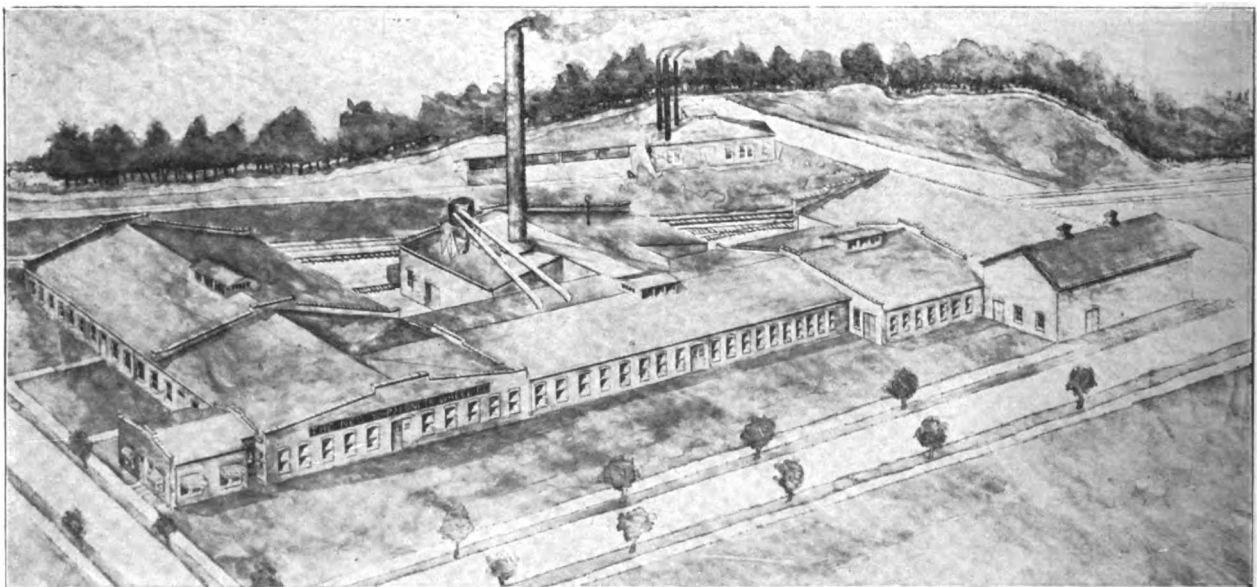

We manufacture Vehicle Wheels of All Kinds; Light and Heavy. Sarven, Warner, Compressed Band
and Wood Hub. Send for our Price List.

THE NEW WAPAKONETA WHEEL COMPANY
WAPAKONETA, OHIO

The Hub



**AUTOMOBILES
CARRIAGES
MOTOR TRUCKS
WAGONS**

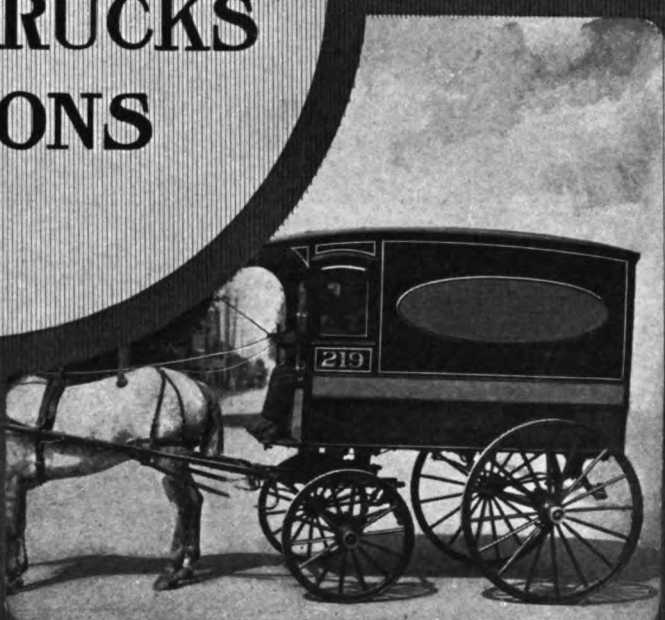
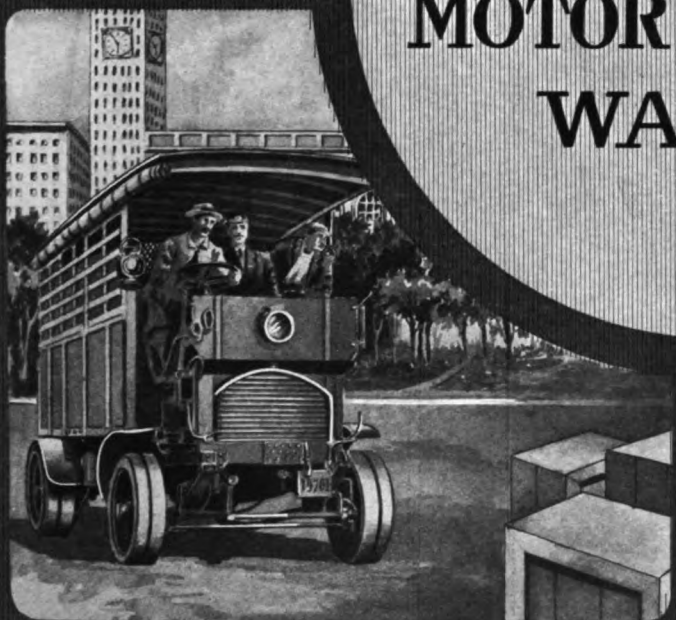

TRADE NEWS PUBLISHING CO
24-26 MURRAY ST., NEW YORK

Hoopes Bro. & Darlington Inc.

West Chester, Penna., U. S. A.

SARVEN
STAR or KENNY
 Sweet Concealed Band
WOOD HUB
WARNER

WHEELS

HEAVY and LIGHT
 for
CARRIAGES
WAGONS and
TRUCKS

IF YOU WANT THE BEST TRY OURS



Load—Ten Tons of Coal.

SOLVED! Is the way motor car experts express themselves on the subject of tires for commercial motor vehicles after seeing and using the

KELLY-SPRINGFIELD SECTIONAL TIRE

With a grip on the road that means progress and security from the fault of solid tires—that of crowding the rubber ahead under load, which means disintegration—the motor wagon and truck owner will find in the Kelly-Springfield Sectional Tire the best tire for all heavy cars. Each section is dependent upon itself. If interested, write

CONSOLIDATED RUBBER TIRE COMPANY

New York, N. Y., and Akron, Ohio

Branches: Boston, Chicago, Philadelphia, St. Louis, Detroit, Cincinnati, San Francisco.



CRANE & MacMAHON, (INCORPORATED)

8-10 Bridge St., NEW YORK CITY, U. S. A.

Sole Manufacturers and Exporters of the

HICKORY NUT,  ACORN,  and STAR  BRANDS OF

Carriage, Wagon and Automobile Wood Stock

FACTORIES:

ST. MARYS, OHIO. RICHMOND, VA.

For Export Prices apply to the New York Office.

The Standard Automatic Brush

Does your painting work in a New Way—better, quicker, cheaper, eliminating all waste of paint. An equal flow at all times: thickness of coat can be accurately adjusted. Absolutely clean and fireproof.

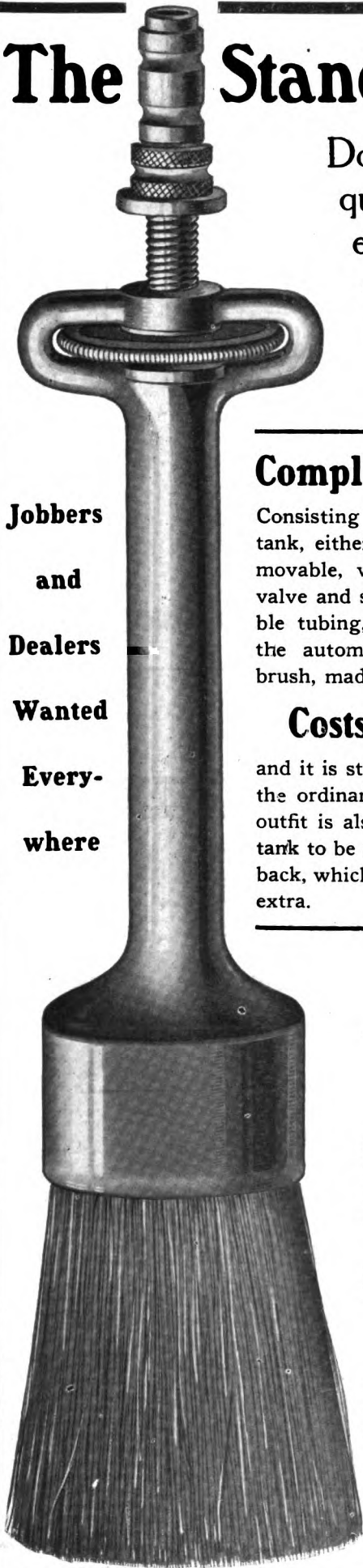

**Jobbers
and
Dealers
Wanted
Every-
where**

Complete Outfit

Consisting of a large paint tank, either stationary or movable, with automatic valve and six feet of flexible tubing, together with the automatic adjustable brush, made of aluminum,

Costs \$7.50

and it is still cheaper than the ordinary brush. The outfit is also made with a tank to be strapped on the back, which will cost \$2.50 extra.

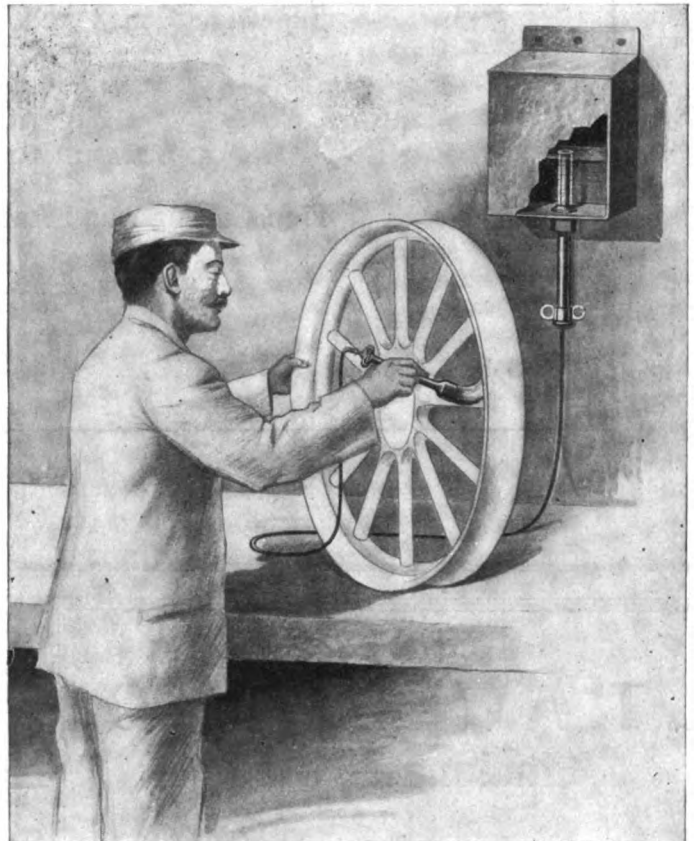

The Standard Automatic System Does Away with the Paint Can

It eliminates the dip and is far superior to the spray, but it does rub it in. No air pressure is needed. Will work with any kind of paint. GET NEXT TO THIS NEW METHOD. Made especially for manufacturers of automobiles, automobile bodies and wheels, all kinds of vehicles, carriages, etc.

Wherever duplication of work exists, this device will increase your output and reduce the cost. Buy just one outfit to-day and be convinced We are sure that we will have to equip your entire plant.

OUR LITTLE BOOKLET WILL TELL YOU WHY.

Write for one to-day. Send in your order. Your outlay will only be once. Apparatus will last a lifetime. Special equipments can be made to suit your purpose. Let us know what you are manufacturing and we will effect a saving for you.

Standard Automatic Mfg. Co.

50 CHURCH STREET, NEW YORK

JOHN W. MASURY & SON

Originators of

Superfine Coach and Automobile Colors

Acknowledged the Standard for Fifty Years

AND MANUFACTURERS OF

Fine Carriage and Automobile Varnishes

New York, Chicago, Minneapolis, Kansas City

THE
A. T. A. NELSON CO.
Cincinnati, Ohio

Cut Leather

All Sizes, All Grades
Pole & Shaft Straps
Auto Straps

Vehicle Trimming Specialties

WRITE US QUICK

THE
A. T. A. NELSON CO.
Cincinnati, Ohio

JOHN REILLY Inc.

Established 1865

MANUFACTURERS OF ALL GRADES OF

LEATHER

FOR THE
Carriage & Automobile Trade

PARTICULAR ATTENTION CALLED TO
OUR AUTO SPECIAL

FACTORIES,
Avenues C & D, Murray & Astor Streets.
NEWARK, N. J.

AGENTS,
Cincinnati—National Hardware Co., Fourth Street
Detroit—C. W. Findlater, No. 313 Forest Ave., West

THE AULT & WIBORG CO. VARNISH WORKS

CINCINNATI, OHIO.

**SUPERIOR CARRIAGE
AND AUTOMOBILE VARNISHES**



The Quickest Thing in Quick Rubbing Varnish; Saves Time and Trouble
READY TO RUB IN 24 HOURS

**If You Have
VARNISH TROUBLES
Come to us.
We Have the Remedy.**

**Factory: Norwood, Ohio.
Branches:
New York, Philadelphia, Chicago,
St. Louis, Toronto, etc.**

**We will sell 100 of these
solid bent seats at cost.**



No. 68.

**A few other styles
for prompt delivery.**

**THE FRANTZ BODY MFG. CO.
AKRON, OHIO.**

**The WEST Hydraulic Tire Setter
WILL CUT DOWN EXPENSE**



Tires set cold in one minute. This machine saves time — does the work better and quicker, does away with burned streaks. Only necessary to measure one wheel in a lot. Does not char the rim and

thus make the tire loosen prematurely. Saves re-sandpapering of wheels.

This machine is now increasing the profits of many manufacturers. Send for catalog and read about it.

WEST TIRE SETTER CO., ROCHESTER, NEW YORK

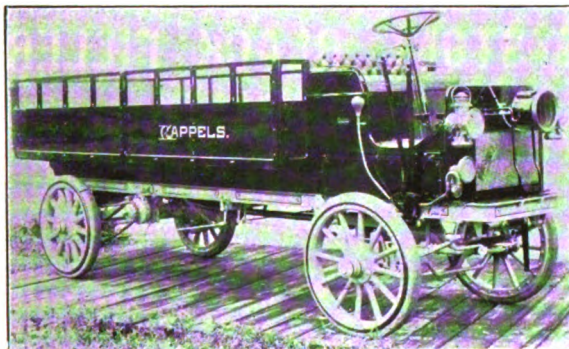

A Two-Ton Furniture Type Truck

“GRAMM”

The World's Best

BECAUSE { **IT HAS THREE POINT MOTOR SUSPENSION
THE WONDERFUL GRAMM CLUTCH
AND IS BUILT EXCLUSIVELY IN OUR OWN PLANT**

CATALOG ON REQUEST

GRAMM MOTOR CAR COMPANY, LIMA, OHIO

Please mention "The Hub" when you write.

Kicks in the Varnish Room? Kicks in the Agencies? Kicks Among the Customers?

We make Varnishes, Colors and Surfacers
on the understanding that Manufacturers
find it Economical to avoid kicks.

The Varnish
That Lasts
Longest

Murphy Varnish Company

FRANKLIN MURPHY President

NEWARK, N. J.

Associated with Dougall Varnish Company, Ltd., Montreal, Canada

BOSTON
CLEVELAND
ST. LOUIS
CHICAGO

WILLEY'S COLORS

The **RECOGNIZED STANDARD**



C. A. WILLEY CO.
COLORS GRINDERS

and Manufacturers of Specialties in

CARRIAGE, AUTOMOBILE AND CAR

PAINTS

COLORS, VARNISHES, ETC.

HUNTER'S POINT, NEW YORK CITY

KIMBLE'S FAMOUS GEAR WOODS

still represent the highest standard of excellence
and quality. True to our motto our line wins the
approval of all vehicle builders.

WHAT CAN WE DO FOR YOU ?

ANDREW KIMBLE
ZANESVILLE, O.

KEYSTONE BLACK FILLER

MAKES A PERFECT

ROUGHSTUFF

For Automobile Bodies and Parts

It fills the pores of Metal and Wood perfectly. Sand-
papers easily and produces a fine smooth surface
that DOES NOT CRACK, SCALE NOR PEEL.

POMEROY & FISCHER, New York
Selling Agents to Vehicle Trade

KEYSTONE PAINT AND FILLER CO., Muncy, Pa.

1832

TRADE **VALENTINES** MARK

1911

Be intelligently selfish and make your business a present
of the best all 'round varnish

Valentine's **VANADIUM** Varnish

It is NOT a costly experiment, is NOT a "just as good," is NOT a disappointing try-out,
is NOT a waste of material and time. It is

THE LATEST ADVANCE IN VARNISH MAKING

The only first aid to the careless, as well as the comfort of the expert—
and it endures beyond comparison!

Just as Good in its Place is

Valentine's VANADIUM COLOR-VARNISH

Why push the business to success in a wheelbarrow when you can use a
motor car for the same money? **LIVE IN 1911 AND GO WITH THE TIDE!**

VALENTINE & COMPANY

New York

Chicago

Boston

Toronto

Paris

Amsterdam

83 Years' Experience in Every Car



Edward Smith & Co.

CARRIAGE VARNISHES

Everything from the
Bare Wood to the Finishing Coat.

CHICAGO

NEW YORK

Jones Wheels

BEST ON EARTH

KANTSAMORE

Phineas Jones & Co.

Newark, N. J.

MOLLER & SCHUMANN COMPANY

COLORED RUBBING

Most perfect as to working, drying and wearing.

CARRIAGE & AUTO VARNISHES

Send for color card and descriptive price list.

Chicago Branch - 110 N. Desplaines St., Office and Factory - BROOKLYN, N. Y.

THE TRADE NEWS PUBLISHING CO. OF N. Y. Publishers of THE HUB

J. H. WRIGHT, *President.*

G. A. TANNER, *Secretary and Treasurer.*

24-26 MURRAY STREET, NEW YORK.

Other Publications of Trade News Publishing Co.:

HARNESS (monthly) per year, \$1.00

AMERICAN HARNESS AND SADDLERY

DIRECTORY (annual) per copy, \$4.00

THE HUB is published monthly in the interest of employers and workmen connected with the manufacture of Carriages, Wagons, Sleighs, Automobiles and the Accessory trades, and also in the interest of Dealers.

Subscription price for the United States, Mexico, Cuba, Porto Rico, Guam the Philippines, and the Hawaiian Islands, \$2.00, Canada, \$2.50, payable strictly in advance. Single copies, 25 cents. Remittances at risk of subscriber, unless by registered letter, or by draft, check, express or post-office order, payable to the order of TRADE NEWS PUBLISHING Co.

For advertising rates, apply to the Publishers. Advertisements must be acceptable in every respect. Copy for new advertisements must be received by the 25th of the preceding month, and requests to alter or discontinue advertisements must be received before the 12th day of the preceding month to insure attention in the following number. All communications must be accompanied by the full name and address of writer.

FOREIGN REPRESENTATIVES:

FRANCE.—L. Dupont, publisher of *Le Guide du Carrossier*, 78 Rue Boissiere, Paris. Subscription price, 15 francs, postpaid.

GERMANY.—Gustave Miesen, Bohn a Rh. Subscription price, 12 marks, postpaid.

ENGLAND.—Thomas Mattison, "Floriana," Hillside Avenue, Bitterne Park, Southampton. Subscription price, 12 shillings, postpaid.

Big Business.

Buggy builders have recorded a large business during the year just closed. It is also said to have been satisfactory. Then followed the usual forecasts of what the future would bring. As chroniclers of trade happenings we doubt our ability to forecast coming events so well as the man at the wheel, hence we will personally know more about the outcome of trade around December than at the dawn of the year.

It seems to be the general opinion that the good trade has been not a little due to condensation of effort, on the plan of the survival of the fittest. What strikes us in this aspect of the subject is the number of husky, hustling concerns there are that have been fit to survive. Those that have dropped out made but little noise when they dropped in.

There is the same complaint among builders that has been heard for years, that is, there is no money in the business, prices are too low, and competition too strenuous. We see nothing in the future tending to improve these aspects of a grinding industry.

Probably there are quite a few buggy builders who have been lured to the gas vehicle to the exclusion of all else, who will find conditions in that branch of vehicle build

ing as tiresome to the pocket as were the former efforts, So much of the gilt is being scraped from the automobile gingerbread that the financial gustatory delights are not what they were. Our little buggy builder friends who dreamed a dream of automobiles will awaken there, too, to find it is difficult to keep going. The overproduction, if it is proved such, will be seen in the motor car trade, as we are already noting the effect by lack of sales on the list price. The price already shows a bad list to port, and if it lists much more, somebody will be spilled out. We hope it will not be the little fellow who has just ventured into the enterprise.

The Ability to Make a Sketch.

The salesman who possesses a little skill with pencil can often make a sale through the graphic presentation of his idea. The customer can understand a penciled suggestion when a description is not clear to his mind, owing to the lack of ability of the salesman to clearly express his idea, using words as the medium.

It is not often possible to have the draftsman at elbow to do the work wanted. This power to use a pencil readily may be easily acquired, if the salesman has an eye for proportion. It would be easy to show the customer a side-light is the same width as a door, but the leather quarter is less wide. Likewise ground, elbow, roof, pillar, and dashboard lines always go in automatically straight away, and one in time comes to judge what are the essential details in a certain body, and to know at the same time instinctively what to leave out so as to save time. It is wonderful the confidence it instills in the salesman's breast when he can "talk on paper," and there are few clients who will not be impressed by the ability thus demonstrated.

Prospects.

We all like to consider prospects. We are so kindly to what we compel the word to stand for that everything from a possible "order" to a hole in the ground in some mining camp is a prospect.

One of the bright, thoughtful buggy builders is a great man for prospects, and he thinks they are unusually luminous for the approaching season because—

The stocks on hand with jobber and dealer are light.

Crops good; and the farmer with more money and fewer debts than ever known, and

The farmer is not convinced that the automobile is in most cases serviceable.

There are other considerations that the gentleman we

quote puts in such a slap-dash, breezy way, that it sounds better as he says than as we write it, so we will quote at length:

The consumer who usually humored himself and family each second or third year to a new buggy, or the latest fad if you please, has for the past two seasons felt himself pinched and hard-up, because he read in New York papers that money was scarce in South Africa.

However, that's all passed now, and we will feel the flow of loosened money unless the auto plants begin to "bust" and scare our bankers to death.

There have been more vehicles repaired and repainted in the last two years than ever known before.

Some dealers who took up the sale of autos have already grown tired of the experiment, they found no profit and this points to a revival in the sale of vehicles and harness.

The coming of bicycles, trolley cars and flying machines did not diminish the sale of vehicles and harness because the farm districts of our great country are developing and growing rapidly.

A few carriage factories have been turned into auto plants. On the other hand several carriage plants have doubled their output and there is new life and bright prospects in the vehicle industry.

BRIEF COMMENT.

Deep quarter panels are more plentiful in the torpedo designs.

* * *

The sleigh trade has been excellent in many sections, some makers putting forth claims of a banner season.

* * *

A lot of the tricks that were put in landaulette and limousine bodies as accessories of elegance are disappearing.

* * *

If 33 pounds pull will move a wagon over a wood pavement, a pull of 147 pounds will be required to move the same vehicle over a newly graveled road.

* * *

The rattle of the car is now coming to the front and means are used to abate it. At first it was all car and price, now it is getting to be car and comfort.

* * *

There is an effort making to reorganize the carriage and wagon workers of Toledo. After existing ten years, the union fell into a state of desuetude about two years ago.

* * *

When Brewster & Co. moved away from the Broadway location the big building looked mighty lonesome, but not long after a fire in his own shops drove Charles Barry into temporary

* * *

The Studebakers have turned out something like one hundred thousand horse-drawn vehicles at the South Bend shops during 1910. This represents something important when the average price is considered.

* * *

A good amount of credit must go to the automobile maker for all we have come to know about the merit of vanadium steel. It was due to his fussiness about the quality of the steel he needed that this very admirable alloy was made fashionable. Even the navy has concluded to squint in the same direction.

* * *

W. W. Herral, the major, one of the very popular brothers responsible for the success of the Fairfield Rubber Co., is recovering from a severe fall resulting in a fracture of the hip, due to an accident in a Davenport, Iowa, hotel. The major, after a month in the hospital, concluded that nothing should stop him from returning home for the holidays, and the festivities of a half-century wedding anniversary. He made the trip without unpleasant incident, and is receiving the congratulations of friends

that he is once more ready to face the slings and arrows of fortune just as he did when a warrior. We take the opportunity to slip him The Hub's felicitations, also.

* * *

The carriage trade is not bereft of its sensational episodes, vide the act of Mrs. Kalish throwing a glassful of carbolic acid into the face of Charles Morbach, son of a wagon manufacturer of means. It all happened in the town where brotherly love is the chief asset, but sisterly love seems to have been left off the inventory.

* * *

The Illinois implement dealers have voted to withdraw from the state fair because Sears-Roebuck Company was allowed to exhibit. The catalogue house people thereupon agree to take all the space thus vacated. It would seem as if the dealers ought to feel not only strong enough, but welcome the chance to show their trade that there was no advantage in catalogue house goods.

* * *

occupancy of a part of the building, so it is still a carriage shop.

An extract from a consular report elsewhere to be found in this issue gives the status of the crude rubber position in the Far East. It is interesting as marking the course of the world-wide speculation in this gum. As rubber is being so generally cultivated over such a wide expanse the day of the debacle, as our French friends have it, cannot be long postponed.

* * *

It is amusing how easily men become obsessed by an idea. President Nash, of the Wisconsin Dealers' Association, is sure the horse is a back number, and he recommends the dealers to dispose of the horse-drawn vehicle stock and stock up with automobiles, or at least, he is so reported in the local press. Wonder if he would also advise the discontinuance of the use of brooms because there are vacuum cleaners in the market. About as sensible.

* * *

The Moon Bros. let no chance go by to take a large handful of buggies wherever vehicle and implement dealers "most do congregate." At the Des Moines demonstration they also had a colored quartette of sweet singers, "by the light of the moon," we suspect. We think it may not be unprofessional to say of the colored brethren that the body color was black picked out with carmine, and the filling was, of course, "roughstuff," and plenty of it. Wonder if their harmony sold the thirty jobs!

* * *

Within the past year or two the electric vehicle industry has come forward with leaps and bounds. Never before since the "horseless carriage" first appeared have such a large proportion of vehicles on the road been electrics.

In the beginning, electricity seemed to be the logical motive power for the automobile. Then, all of a sudden, the electric took a gigantic slump, for a number of very good reasons. First, the rapid development of the gasoline engine, which apparently was much better adapted to the rough usage and intense vibration of the car in covering average roads. Second, the fact that the storage battery was easily injured by the rack and jar of rough going and it was heavy and cumbersome. Besides, its performance was so inconsistent that one could gain no definite idea of the average mileage it would give on a single charge. And at that time charging stations were so few and far between that it was impossible to know when you started out whether you would reach the next charging station before your battery was completely discharged. And complete discharge at that time meant expensive repairs or a new battery.

So the electric became a city vehicle, and even at that was everywhere regarded as an expensive luxury.

Still, in the face of all these difficulties, Thomas A. Edison contended that electricity was the proper motive power for the automobile and that the electric vehicle, with the proper battery equipment, would prove to give not only the best, but by far the cheapest transportation the world had ever known.

Vehicle Fashions for January 1911

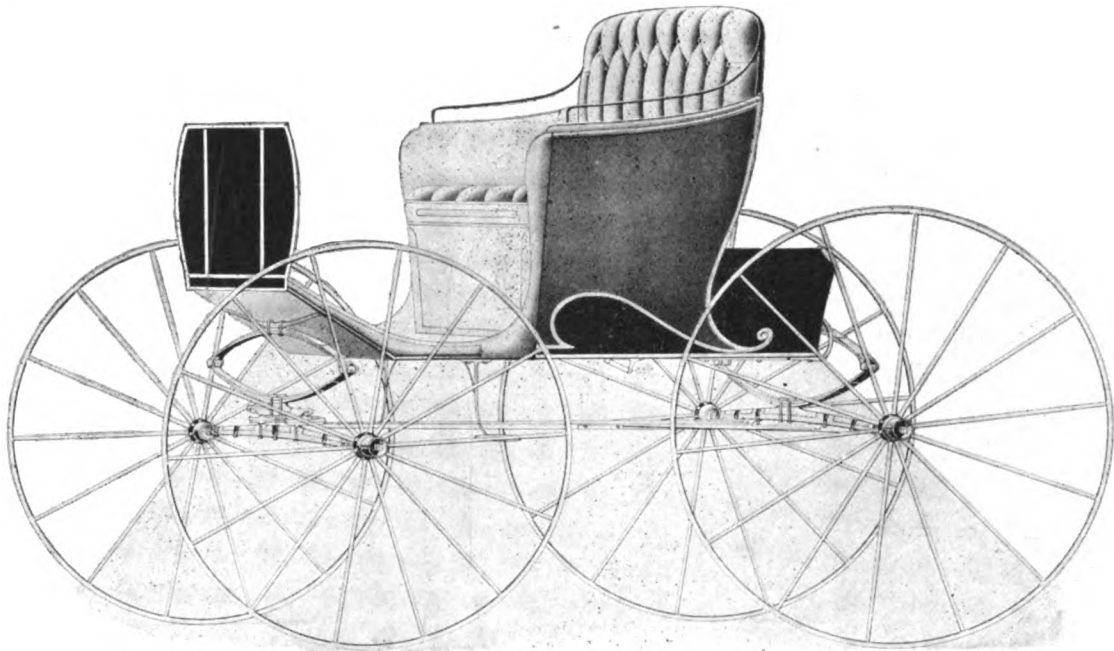

STANHOPE.
Built by D. M. Sechler Company.

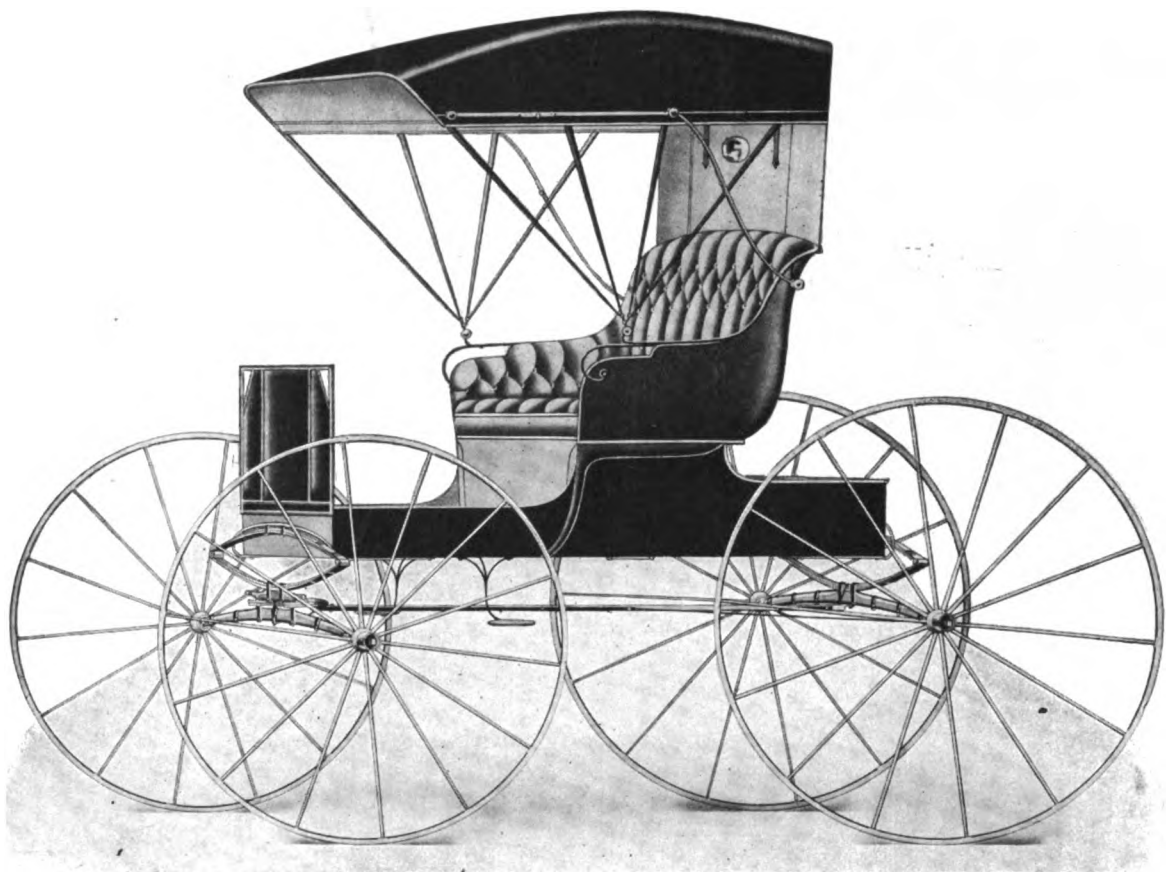

AUTO-SEAT BUGGY.
Built by D. M. Sechler Company.

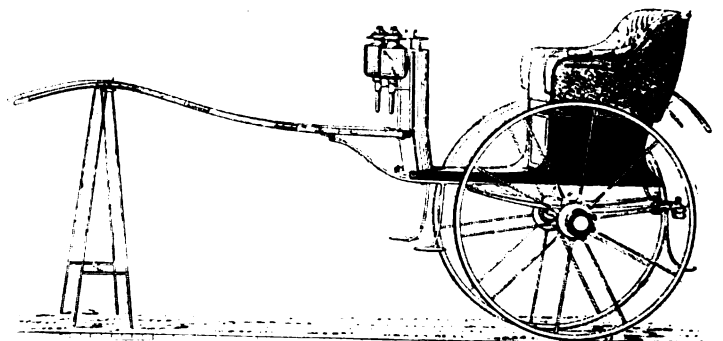
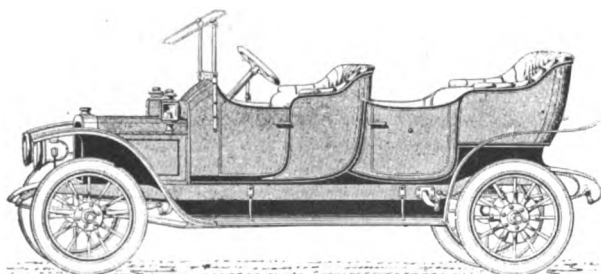
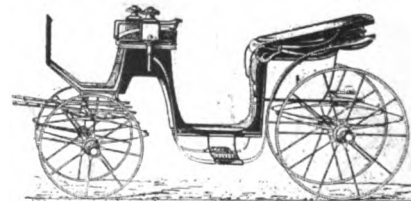
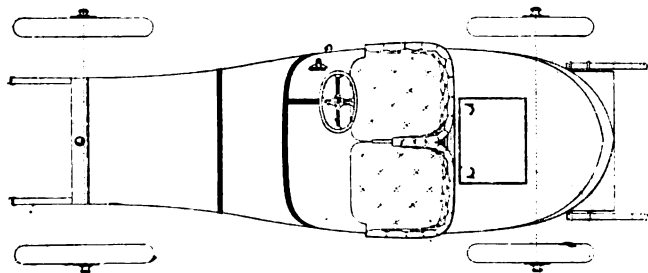
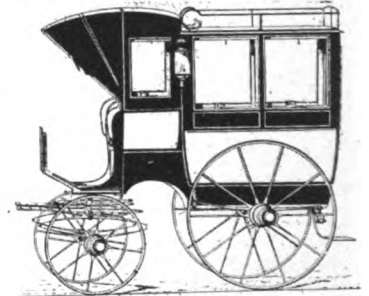
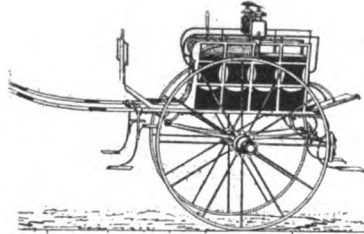
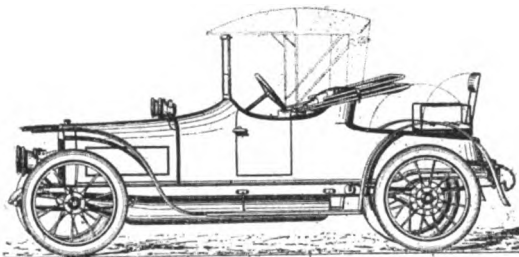
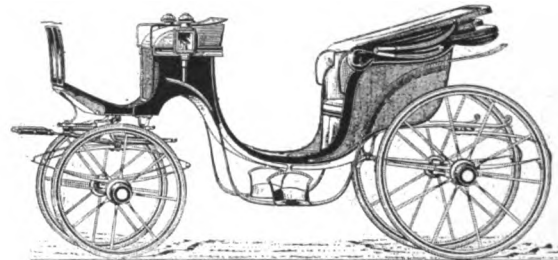
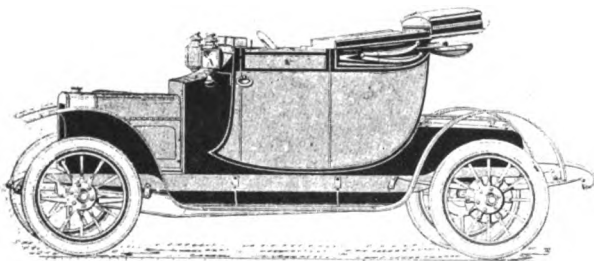
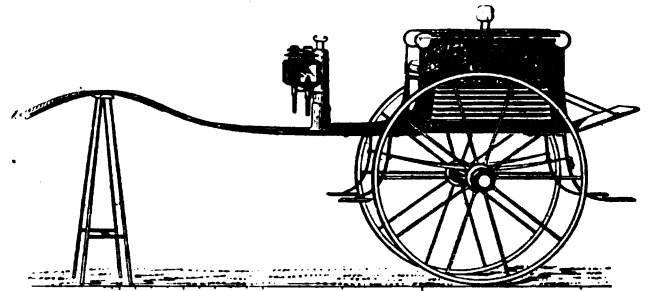
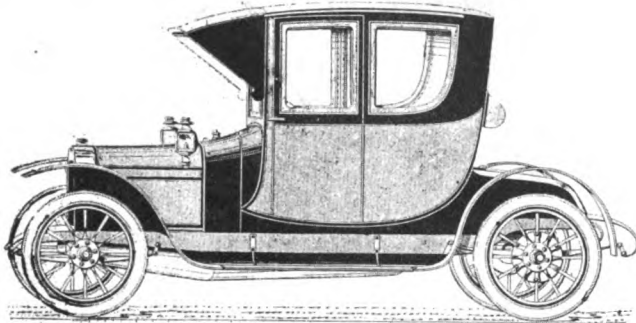
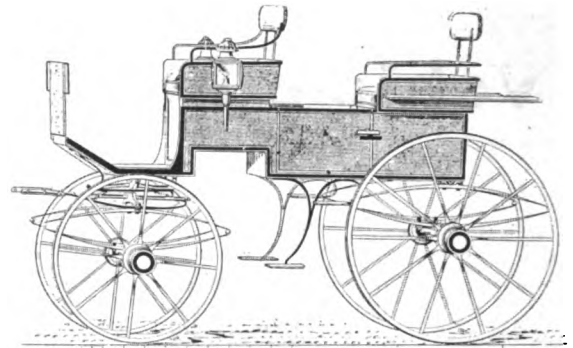
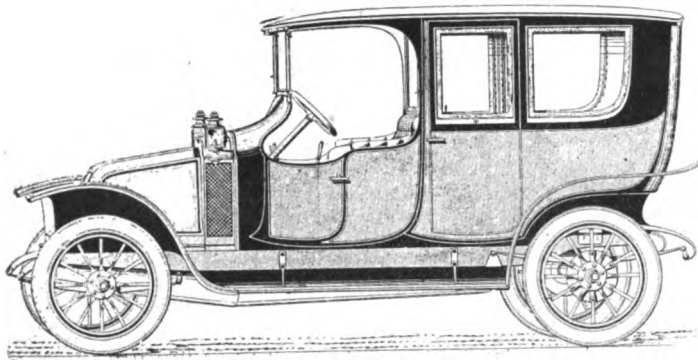

LATEST FOREIGN FASHIONS.

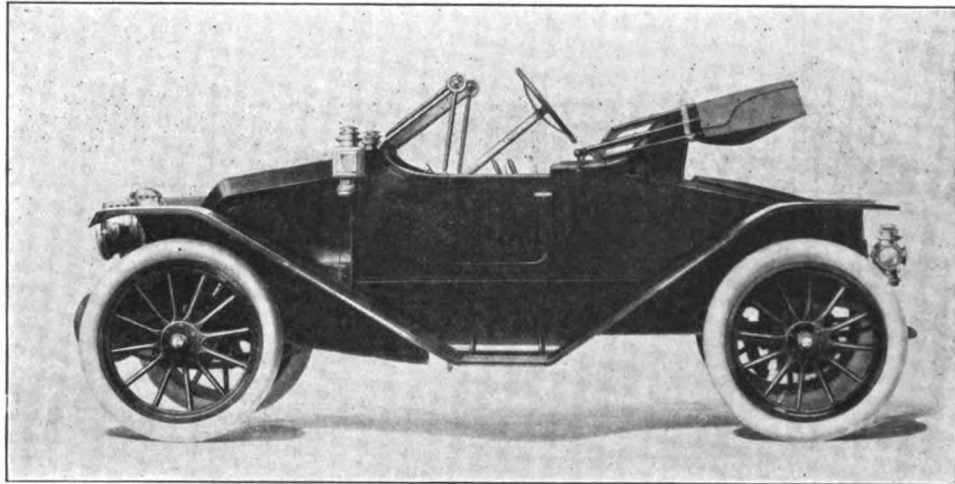

TWO-PASSENGER TORPEDO PHAETON.
Built by Franklin Automobile Co.

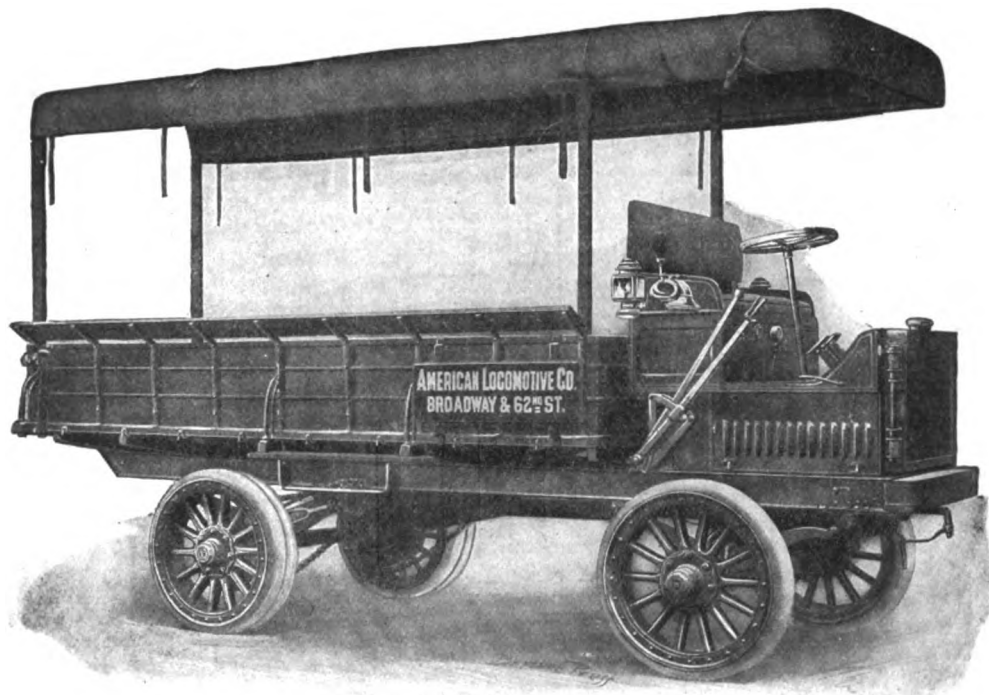

COMMERCIAL TRUCK.
Built by American Locomotive Company.

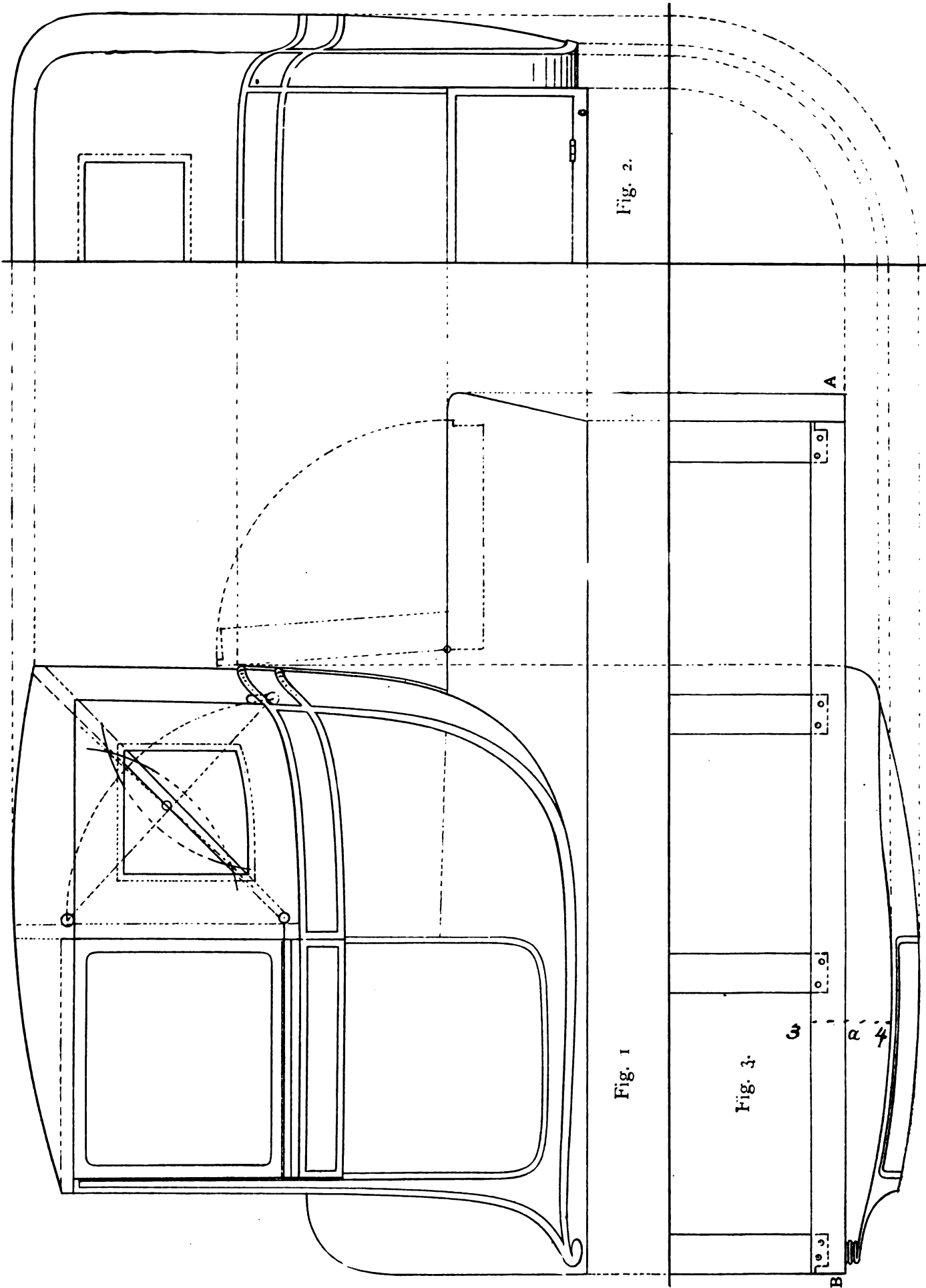

Fig. 2.

Fig. 1

Fig. 3.

WORKING DRAWING OF LANDAULETTE MOTOR BODY.
(Described on Opposite Page.)

Wood-working and Smithing

WORKING DRAWING OF LANDAULETTE MOTOR BODY.

(Drawing on Opposite Page.)

The Hub has used its constant efforts to keep its subscribers in the van of progressive manufacture ever since the motor carriage became a controlling element in carriage building.

The working drafts in each issue of The Hub have shown a varied and exclusive design of body. The lines and proportions have been evolved from a study of the world's markets, which, by a singular characteristic, is very barren of a striking individualism.

The design given here is a style of single car that is at present in great demand by those who like to drive themselves, and whose needs are answered in a light and efficiently engined vehicle of light draught and quick speed.

The lines are those obtained at the English exhibition in London, though the draft is not altogether a dead following, but the character and style to fill a void in motor demand is. We have sailed thus near the wind of fashion and style to keep The Hub's subscribers posted with up-to-date fashion and the grooves it is running in.

The hind quarter is cab-phaetoned in lines and depth, which provides a longer surface to give a living force to controlling corner pillar line, as it boldly strengthens itself in the corner and faintly vanishing to the coupe pillar whose carved end is inverted, thus allowing the front line of the pillar to run into a finishing harmony.

The door is corner curved on both sides, which both strengthens the front pillar and the standing pillar of the quarter. The door is fitted with a portable top light, so that when the car is fitted with an inward folding mechanism on the landaulette principle which prevents elongation as an open carriage. The head appears as a canopy with back and corner belt, but when required as a closed car there are side pieces of waterproofing which button on and is provided with a celluloid light, in the side, as is shown in the draft.

The head fitting and the door arrangement will form the subject of articles specially devoted to these inventions and improvements.

The depth of the body is cut up with a belt paneling in which sham cane work or fancy carved paneling can be worked up as are relief decorations.

The corner of the body is round cornered and curved in vanishing to the bottomside line; this makes a smart cutting relief to the length of the quarter both in depth and in fore-shortening it. The body is fitted with a hind box boot, which is used as a store for a spare wheel, and the door portable light. The top of the boot can be utilized for strapping luggage on, while the back of the boot is provided with a door as in Fig. 2. The boot can be fitted with a top flap door, and a back one as well.

The bottomside of the body is made in one piece, and cut back to the line of the boot to which it is fitted and screwed up from underneath—the boot bottomside shows the line of the chassis, and the turnunder line of the body on the plan shows the amount of projection the body stands over the body at that part. The full distance on the finished turnunder of the bottomside is from 3 to 4, but of course, in cutting out, a wider allowance has to be made for the side bevel on the turnunder pillar to work up to a full point as far as the door line of the body.

The car makes a very smart professional vehicle most suitable for doctors and business men requiring a quick haulage from

point to point, while it is of taking design and admirably suited to self chauffeuring.

Fig. 1 shows the full design and fittings.

Fig. 2 shows the half back view and design of the moulding following line of boot and canopy head outline from this section.

Fig. 3 shows the half plan of the body and its widths from every point as the body is showing upside down. The base line of the body is, of course, the outside controlling line and a regular sweep on the elbow line. The point of the turnunder line is shown, in chain line as projected from the body from the back section in Fig. 2.

The turnunder line is only a regular curve on the width of the door, and then irregularly returns to the elbow point. This is, of course, owing to the elevation shape of the hind quarter, which can be finely traced from the points of turnunder to the body and projected to the plan. It is not at all necessary to show this detail here, it has been fully measured off and worked into position as explained—this the fully experienced and technical body-maker understands. The boot is solid-sided stuff, 1 in. birch makes the best siding. The bottomside to which the bootside is half check framed is cut back from the full width at 3—4. The standing pillar of the body and the corner pillar of the quarter are framed into the bottomside, a method which has been fully explained in the working drawings of back numbers of The Hub.

The sizes for building the body are: Full length of body on chassis, 7 ft. 2 in.; width of chassis, 35½ in.; width of body on bottom of boot, 36 in.; width of bottomside on boot, 3½ in.; across center at 3—4, 8¾ in.; the bevel to flush up in the turnunder up to the door bottom must be added to this. The line A—B is really the chassis line and the distance from 4 to a the amount of projection of the body over the chassis at that point. Full width of quarter on elbow line, 27 in.; width of quarter to controlling body line, 23½ in.; full depth of quarter on standing pillar line from top to elbow moulding, 2 ft. 5 in.; over mouldings, 2 ft. 3½ in. Width of door 24 in.; depth of ditto from bottom elbow moulding, 18½ in.; full depth of waist rail, 6 in.; depth of quarter belt rail over moulding 3½ in.; width of bottom of coupe pillar on a straight line over eye, 9 in.; width of pillar at top, 1½ in.

Length of boot top from body, 2 ft. 6 in.; width on top, 36 in.; depth of side, 14½ in.; width of bonnet quarter, 8 in.; width of body across elbow point, 46 in.; across inner moulding point, 36 in.; width across standing pillar, 50 in.; across front pillars, 46 in.; depth from seat line to top of roof slot, 45 in.

BABBING METAL.

After removing old babbit heat the box to be babbited to burn all oil and aid in making solid when the new box is poured be sure to clean out small holes which hold babbit. Clean all parts as much as possible, as the cleaner the better. Now to keep shaft from clinging to babbit, my idea is that to smoke the shaft is a little the best. Put an even skum of soot all over it at places where metal touches the shaft. If the box is solid simply place the shaft in the center of box, plastering up the places of leakage with putty, and pour, but if the box is in halves, a little more precaution must be taken. Wooden liners are about the best. Cut a few small nicks in the edge next to the shaft, pour, pull out liners, scrape and smooth up box, cut oil holes and it is finished. Another thing which I forgot to mention is to put a small lump of resin in the box before pouring as this puts a stop to those gases which sometimes cause trouble, and aids in holding babbit the same as it does in soldering.

CUTTING GEAR TEETH IN PATTERNS ON A BAND SAW.

A device whereby the teeth in bevel gear patterns can be cut on the band saw is shown in the accompanying sketch. With this device the teeth can be cut much more accurately and quickly than shaping them by hand. Having the blank gear pattern, A, turned to the proper size, lay out the teeth on the pitch line as

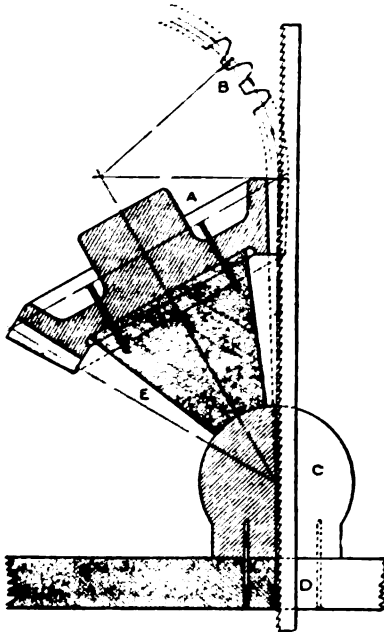

Sawing Teeth on a Pattern

shown at B. Turn up a round ball, C, in the lathe, and fasten it to a board, D, with nails as shown.

Turn up a cone, E, of the proper length and hollow out one end to fit this ball. Fasten the blank gear to the cone, being careful to get it exactly in the center. Saw through the board and fasten the board to the saw table in this position. By holding the cone ball to the exact center of the ball and against the blank the teeth can be sawn out according to the layout on the blank. This device is also very handy for making experimental wooden gears.

PITCH OF SPRINGS.

It has been asked (subject, building a platform gear for a survey), is it customary to elevate the springs in front ends?

There is a rule, considered standard, which advises, in setting up the front carriage part, to place the fore end of the springs as much higher as the same will be likely to drop when under the body, (with pole in) and being drawn at from four to six miles per hour over an average road.

The fifth-wheel is then placed a trifle low behind, $\frac{1}{8}$ -inch or less, or about as much as the upper part of the gear will yield to level when under same strain as above stated.

The result, after many observations, was placed at from one to one and a fourth inches, according to weight of pole, etc., for 38 inch to 40 inch springs.

For rear springs the same length, from $\frac{1}{2}$ to $\frac{3}{4}$ -inch was considered right, the object being to bring the top side of axles to the horizontal lines, so they would run over level bearings (plumb spoke) and in parallel lines.

This, we believe, is the present practice by good builders

IN BRAZING.

To prevent the "bubbles" often occurring in the use of borax, use boric acid and sodium carbonate, of which borax is made and all difficulty will disappear.

A HARDENING COMPOUND FOR STEEL(?)

We find the formula given below in a technical journal that pretends to know what it is talking about:

Sal ammoniac, 1 oz.; corrosive sublimate, $\frac{1}{2}$ oz.; salt petre, $\frac{1}{2}$ oz.; borax, 1 oz.; oil vitriol, 1 oz.; salt, 1 lb.; alum, 1 oz.; soft water, 2 gallons. Into this stew it is recommended to plunge the hot metal and harden it.

Let us look into the action of the above ingredients and see what kind of a prescription this trade journal doctor of metallurgy has given us.

Sal ammoniac is mainly useful for solderers of metal for cleansing the point of a soldering iron. It is nitrate of ammonia. It exerts no influence on metallic iron that anyone knows about.

Corrosive sublimate is a poison of an acute kind. It is compounded of mercury, by weight, 2 parts; sulphuric acid (oil vitriol), 3 parts; chloride potassium $1\frac{1}{2}$ pounds, then sublime by heat. Mercury has no influence or effect on steel.

Sulphuric acid is harmful to a large degree to metallic iron, and would quickly eat holes into it if left immersed in the fluid.

Chloride of sodium (salt) has some small hardening power over iron and steel. Its vapor is poisonous in conjunction with some of the above, and is injurious.

Alum is a combination of sulphate of alumina and potassium. Its only value as a hardening material would lie in the small amount of potassium it contains, merely a few grains. It is a good mordant for dyers, but the metal worker does not find it useful.

Borax is borate of soda. It might cleanse and soften the water, but its value would stop there.

Oil of vitriol comes under the remarks about corrosive sublimate.

Salt is the only mixture in the formula of any practical account.

The quantity of water stated would effectually neutralize all the rest of the nonsense.

A HOME-MADE JACK SCREW.

The accompanying sketch shows a small jack which is cheap, simple and quite useful in the shop. All that is required is a $\frac{3}{8}$ -in. by 8 in. bolt, one washer, a piece of 1-in. gas pipe, 8 in. long,

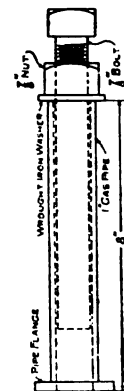

and half of a 1-in. pipe flange. It is astonishing how much this little jack is capable of raising, says a correspondent of the Practical Engineer. It does not require over 10 minutes to make.

CARRIAGE BUILDERS WANTED IN AUSTRALIA

The annual report of the Master Carriage and Wagon Builders' Association, Adelaide, states that, owing to the scarcity of skilled mechanics in Australia, through which many firms have been obliged to refuse orders, the British Immigration League of Australia has been asked if it is possible to secure mechanics from the United Kingdom. The league is taking steps to supply the carriage builders' wants.

WAGON BUILDERS VISIT WORKS OF HOOPES BROS. & DARLINGTON AT WEST CHESTER, PA.

On November 29th wagon builders and those interested in the trade visited the works of Hoopes Bros. & Darlington at West Chester, Pa. The delegation representing the Carriage and Wagon Builders' Association of Philadelphia left Broad Street Station at 11.04 A.M. and on arrival were escorted to the leading hotel where a dinner, consisting of everything in season, was prepared, after which a thorough inspection was made of the plant and questions answered to the full satisfaction of everyone. Wheels were put through in a manner that was very instructive. Everyone was impressed with the large stock of well seasoned material on hand, and the exceptional care taken by the workmen. During the afternoon an alarm was sounded and in 1½ minutes three streams were put on the buildings forced by the firm's own pump running at high pressure, supplying a thousand gallons a minute.

Among those present were Chas. Preisendanz, president of the Carriage Builders' Association of Philadelphia; Wm. Gerhab, Wm. McConigal, J. H. Risdon, Fred Scherrer, Chas. Wacker, H. Kerstein, A. J. Ayers, A. C. Fischer, H. A. Kline, R. Arthur Bit-tong, J. Halton, Wm. Wedekamper, A. P. Cardwell, Edw. Preisendanz, Chas. Hassett, Samuel Shisler, J. H. Schumacker, Chas. A. Heergeist, Thos. J. Manning, Louis A. Ohme, A. Wojezynski, H. F. Keachline, secretary Carriage Builders' Association of Philadelphia; W. E. Marbaker, J. E. Rech, L. I. Hall of Carnegie Steel Co.; W. L. Taylor, president Keystone Spring Works; Geo. Bittorf, Wm. E. Dennis, Wm. B. Morgey, Wm. Petry, Wm. P. Hansell, Wm. H. Godshall, B. R. Richards, John Dengelden, J. F. Mitchell, M. C. Edwards, of Cambria Steel Co.; Albert Kohler, Emile Insinger, Fred Fischer, B. Frank Duffield, E. C. Everhart, F. W. Seese, R. C. Ware.

DEMAND FOR CARRIAGES IN WEST INDIES.

In the past year there have been imported into Guadeloupe 30 carriages, of which 28 came from the United States. Some of these were imported for private use by the purchasers; but a number were brought in for sale, and these latter were almost without exception disposed of before it was possible to complete the customs formalities. The average entered value was \$130; although most of those for sale were second-hand buggies or runabouts, they were sold at an average price of \$150. American vehicles are very popular here on account of their lightness; local roads are steep and bad and the horses small. Metal axles are especially in demand—the light appearance counts. Catalogues could be made good use of at the consulate.

"MORE RESILIENT THAN AIR."

The Endurance Tire Co., of Detroit, capitalized at \$150,000, has for its object the production of a solid rubber tire invented by H. Hodgson, which is claimed to be "more resilient than air." The tire is formed by rubber sections held by a steel case, a hoop of steel supporting the tire with a ¼-inch air space between the hoop and the rim. In addition to Hodgson and his attorney, Edward Pokorny, the men interested in the venture are Joseph L. Schlund, George D. Reid and Arthur H. Britton.

FOREIGN TRADE OPPORTUNITIES.

An American consular officer in Russia reports that a business man in his district is in the market for axles for heavy and light carriages and trucks on lateral rollers and ball bearings, each kind separate or a combination of both wheels with pneumatic and solid tires for carriages and light vehicles; whole hides of patent and lacquered leather for carriage tops, aprons, boot tops, and the like.

PRICES OF RUNABOUT BUGGY REPAIRS.

| | |
|-------------------------------------------|------------------|
| Bottom in body | \$1.50 to \$2.50 |
| Panel, front or back | 1.75 to 3.50 |
| Panel, side | 2.50 to 4.50 |
| Removing and replacing body loops | 1.00 |
| Sill, end | 1.50 |
| Sill, side | 1.75 |
| Seat panel, side | 1.75 to 3.25 |
| Seat panel, back | 2.00 to 3.75 |
| Seat frame in bottom | 1.25 to 2.75 |
| Seat, complete | 3.50 to 6.50 |
| Axle bed, replacing irons | 2.50 to 3.50 |
| Body loop ends | 1.50 to 2.00 |
| Bolts, each | .05 to .10 |
| Clips, axle | .25 to .35 |
| Clips, saddle (single) | 1.00 to 1.25 |
| Clips, 2 saddle and plate | 1.00 to 1.25 |
| Cross bar in shaft | 1.50 to 2.00 |
| Fifth wheel, Derby, single perch | 2.50 to 3.00 |
| Fifth wheel, Derby, double perch | 3.00 to 3.25 |
| Head block, plain scrolls | 1.75 to 2.25 |
| Head block, fancy scrolls | 2.50 to 3.00 |
| Head block, plate, single perch | 1.75 to 2.00 |
| Head block, plate, double perch | 3.00 to 3.50 |
| King bolt (clip) | 1.25 to 1.50 |
| King bolt, plain | 1.00 to 1.25 |
| Perch (1) straight replacing irons | 3.00 to 4.00 |
| Perch (1) bent, replacing irons | 4.00 to 5.00 |
| Perch (2) bent, replacing irons | 5.00 to 6.00 |
| Perch plate, welded, single | 2.00 to 2.50 |
| Perch plate, double | 2.50 to 3.00 |
| Perch end for double perch | .90 to 1.00 |
| Shaft Beam (1) and replacing irons | 2.50 to 3.00 |
| Shaft Beams (2) and replacing irons | 4.50 to 6.00 |
| Single-tree | 1.00 to 1.25 |
| Shaft-Eyes (2) and bolts | 1.75 to 2.00 |
| Single-tree Plates (lock pat.) | .50 to .75 |
| Setting Axle | 1.50 to 1.75 |
| Spring Bar, fancy scrolls | 2.25 to 2.50 |
| Spring Bar, plain scrolls | 1.75 to 2.00 |
| Shaft Clips (2) | 1.75 to 2.00 |
| Shaft Clips (1) | 1.00 to 1.00 |
| Stay heel | .75 to 1.00 |
| Spring bar clips, each | .25 to .40 |
| Step welded solid on body loop | 2.50 to 3.00 |
| T—in shaft iron | 1.25 to 1.75 |

WATERPROOF CEMENT RECIPES.

1. White lead, red lead and boiled oil mixed together with a good size to the consistency of putty.
2. Dissolve 1 oz. powdered resin in 10 oz. strong ammonia and add 5 parts gelatine and a 1-part solution of acid chromate of lime.
3. For a waterproof paste cement add to hot starch paste one-half its weight of turpentine and a small piece of alum.
4. For lining cisterns, make into a paste with boiled oil 2 parts each of powdered brick, quicklime and wood ashes.

WILL MAKE AUTO TOPS.

The Marshalltown Buggy Company, of Marshalltown, Ia., has begun the manufacture of a new type of automobile top invented by Joseph Lemp, superintendent of the company's plant. The top will be built to order to fit any automobile.

BOILER COMPOUND FORMULA.

Sal soda crystals, 18 lbs.; dextrin, 18 lbs.; alum, 6 lbs.; sugar, 6 lbs.; crude potash, 3 lbs. It gives fine satisfaction.

"THE PRESIDENT'S DINNER."

For years it has been usual for the "new" president of the Carriage Builders' National Association to "give a dinner," which has come to be called the president's dinner.

This function occurs at the close of the meeting of the Executive Committee, which is held in New York City, always in November of each year.

This dinner is a function of courtesy. There is nothing obligatory attaching to it, but custom has given it almost the force of a mandate.

This time, November 19, it was the "turn" of Mr. Charles J. Richter, and he selected the Hotel Astor.

It was a fine function, given in what is called the "yacht room" of the hotel, a room in its construction and decoration intended to be a replica of a ship's cabin. As has become the custom, also, in recent times, everyone, save the host, who acts as toastmaster, is called upon to reply to some sentiment proposed by the host. So it is a feast of reason as well.

The dinner was served according to the following:

MENU.

Caviar d' Astrachan sur socle.
Tortue Verte Claire a la Fine Champagne.
Hors d'Oeuvres Varies.
Filet de Sole a la Marguery.
Poussim Dessose aux Champignone Frais
Pommes de Terre en Noisettes. Petite Pois au Beurre
Terrapin a la Maryland.
Sorbet au Rhum.
Pluvier Dore Roti sur Canape.
Salade Tropicale.
Glace Rosadelle.

Friandises

Fruits Assortis.

Cafe Noir.

Chateau Yquem, 1898, White Rock,
Moet & Chandon, Imperial Crown Brut

The following members of the Executive Committee of the C. B. N. A. and the other guests of the President were at the dinner: Daniel T. Wilson, T. M. Sechler, Theodore Luth, Charles C. Hull, Warren D. Oakes, George A. Brockway, Morris Woodhull, J. D. Dort, Maurice B. Connolly, Louis Strauss, Fred B. Judkins, Chas. A. Lancaster, Col. Franklin Murphy, Jr., A. Lawrence Phillips, John F. Galvin, W. W. Ogden, Louis Rouillion, John McGrath, Andrew F. Johnson, Edward W. Kearney, W. H. Roininger, C. H. E. Redding.

FLORENCE WAGON WORKS MAY BE MOVED TO DECATUR.

That the Florence Wagon Works will be moved to Decatur, is now practically assured, says a dispatch in the Birmingham News. John W. Fry, president; Sam. C. Harlan, general manager, and Mr. Williams, architect for the company, have just looked over the two Decaturs. They were delighted with the situation. They are figuring on buying the plant of the old United States Rolling Stock Company in East New Decatur. The rolling stock property covers nearly fifty acres and contains several fine buildings. This plant has been lying idle for several years, and, it is said, that it is now offered to the Florence Wagon Works for about one-fourth of its actual value. Within the next few days it is expected that the matter will be closed up. The Florence Wagon works is the fourth largest wagon factory in this country. They employ over 200 mechanics at good wages.

NEW OFFICERS.

At the annual meeting of the Manufacturers' Implement and Vehicle Club, Des Moines, Ia., A. J. Ash was elected president; C. H. Turk was re-elected secretary, and J. W. Gilmore, treasurer.

MOLLER & SCHUMANN'S MEN CONVENE.

The "convention" of the selling staff of the Moller & Schumann Co., which was held on the 13th, 14th and 15th of December, was attended by salesmen from all territories, with one or two exceptions, and while a most enjoyable affair in a social or fraternal sense, was beneficial to all of the salesmen as well.

The social feature of the convention consisted of lunches, a dinner at the Midwood Club and a theatre party.

The most important feature of the meeting was the lecture and scientific demonstrations by Dr. Charles Lipschitz on physical and chemical drying of oils and varnishes, embracing the preparation and application of varnishes, both air drying and baking, and pointing out the conditions under which they are applied, and the means to overcome the difficulties that consumers are experiencing every day.

Addresses were made by Mr. J. H. Schumann, Jr., president, on the growth of the business and prosperity of the trade generally; by Mr. Herman Uehlinger on "Credit;" by Mr. W. R. Hyde, on "Salesmanship," and Mr. Charles Neues on "How to Improve Trade Conditions," followed by Mr. Jabez Gorham, manager of the Chicago branch, and Mr. F. C. Schaefer, special western representative, and others.

The following representatives were in attendance: John H. Mills, H. Kalkbrenner, Simon H. Bodenheim, Gabe Bodenheim, Wm. Gloeckner, Chas. B. Dreyer, Jabez Gorham, Frank C. Schaefer, Henry Holzman, Ernest Loebel, Philip Carr, Wm. J. Woody, Geo. W. Clarke, H. G. Bailey, A. C. Lamar, Oscar Smith, Wm. B. Bohn, Christ Wesp, E. W. Grant, R. H. Adelmann, R. A. Bautz, H. E. Colburn, Geo N. Davenport, W. A. Getty; Chas. Neues, correspondent; W. R. Hyde, sales manager.

PHILADELPHIA CARRIAGE BUILDERS' MEETING.

The regular monthly meeting of the Carriage and Wagon Builders' Association of Philadelphia was held on Friday evening, December 16. Charles Preisendanz, the president, being unable to be present, the chair was occupied by William B. Morgey. The subject of "Selling Terms and Collections" was continued from the November meeting. Charles H. Hassert led a profitable discussion of the question. In addition to being president of the Kessler Wagon Co., Mr. Hassert is a lawyer, and gave sound and practical advice to those who sell vehicles on other than spot cash basis. A committee consisting of Messrs. Marbaker, Egan and Bittong, was appointed to draft a letter of sympathy to be sent to the widow of Joseph O. Hutton, late of the Schrack Varnish Co., Philadelphia, and a member of the association, whose funeral occurred on December 14.

STOCKHOLDERS' MEETING CALLED.

Notices have been sent out for the annual stockholders' meeting of the Columbus Buggy Company, Columbus, O., which will be held at the company's offices January 10. The reports will show that in spite of dullness in some industrial lines, the year now closing broke all records in point of business in the history of the company. October and November of 1910 were two of the largest months on record, and December bids fair to equal if not excel those months. Orders show that the vehicle trade is now improving all over the country. The outlook for the coming year is said to be the best ever known by the officers of the company.

VEHICLE CONSOLIDATION.

The Edgerton Wagon Company, recently established at Edgerton, Wis., is reported to have purchased the business of the New Stratman Vehicle Company, of Dodgeville, Wis., and will consolidate the two industries at Edgerton. The Stratman concern manufactures wagons and carriages, making a specialty of a milk wagon.

Carriage and Automobile Painting

NEW METHOD OF PAINT AND VARNISH CUPS.

Notwithstanding the long-established use of varnish cups the man of the brush and can of to-day manages to get along with the same primeval varnish cup as did his artistic predecessors of past decades. Fig. 1 is the plain old original tin cup, just like the one thrown into the potato patch by Wordsworth when he quaffed his first quaff from the dear old oaken bucket which hung in the well.

The ordinary jack-leg painter to the expert varnisher might exclaim: "The tin cup is good enough for me, I fail to see anything wrong with it. Please tell me where the fault lies if you can?" It can be done very readily. In the illustration, Fig. 1, B shows the opening at the top, A the body of the cup, C the handle, D the bottom, just where some of the mischief lies. The

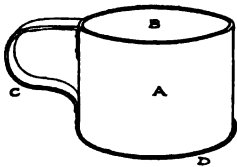

FIG. 1.

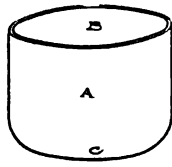

FIG. 2.

bottom is made of tin and is joined to the body by means of locking and soldering afterwards to prevent leaking. The joint on the inside forms a more or less open corner into which all fine particles of dirt, sand, or other unworthy material usually finds its way, and once there, remains. Boiling in alcohol, benzine, potash, or water will not dislodge it.

However, as soon as the varnish enters the cup it forms an affinity with it, coaxes it out when the brush lifts out of the varnish, and permits its roaming around to all parts of the varnish in the cup, trying its best to connect with the brush, with no other object in view than to get brushed off onto the object to which the varnish is applied. When the job is done and varnish has set, we hear something like this: "Well now, what do you know about that?" "Where did that sand come from?" which is part of the story, and is a re-singing of the same old song.

This "deviltry" may be overcome by means of a common-sense cup, of which Fig. 2 shows the ground work. A body of cup, B opening at top, C the bottom, which is one piece with the body, and is either spun or struck up with a die. In this bottom there is no seam for collection of impurities. Fig. 3 is the

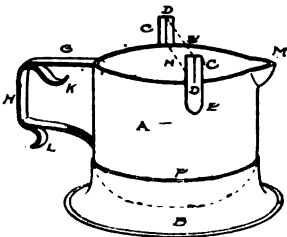

FIG. 3.

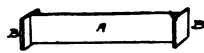

FIG. 4.



FIG. 5.

cup complete—A the body, B a skirt soldered onto the outside of the cup at F, usually denominated a petticoat, the object being to give the cup a firm stand. C, C are two uprights with slots at D D and are secured to the outside of the cup at E E. Dotted line N shows the scraper as adjusted to slots D D. G is the upper part of the handle which has the hook K on the under side, into which the forefinger fits and holds the cup from tipping. H is the back or grip of handle with the hook L, which just fits the hand and helps hold the cup secure. M is the ear by which the varnish may be poured out without splashing.

Fig. 4 shows the scraper with ears or lugs B B, at the ends, to prevent slipping. This utensil may be made of sheet brass or zinc, latter preferred.

Fig. 5 is a dear little sand jaker. A the open top, B the rounded bottom which catches all precipitations and fits in the cup snugly and clears the bottom just a little. C C are little ears by which to lift out the little jaker. You can clean it out with turps and pour the material into rough priming pot. The whole may be made of porcelain, or vitrified earthen ware. Metal is the better material and nothing is better than good tin sheets.

HANDLING A PENCIL.

A first-class pencil hand ought to have a good knowledge of design and drawing to back up his facility with the brush. He may never aspire to be a designer, but he ought to learn to draw in order to be able to use his pencil more freely. He knows why things take certain shapes, and why a curve should be fuller in one place than another. If a design has to be modified to fit some awkward corner or to go round a corner he can do what is desired. There is a point worth noting in this connection which is very apt to be overlooked. It is practically impossible for one man to make a faithful copy of another's work. To begin with want of knowledge handicaps the copyist—he does not know the specific reasons for doing things in certain ways—and when a fuller training gives him the missing information, a certain amount of personal prejudice or preference, often quite unconscious, springs up to modify his rendering of the model. But, on the whole, the most satisfactory work is that produced by the man who knows. Though it may not be in every detail all that the designer wanted, it will be strong and virile, its curves will be vigorous and confident.

The industrious student must study old work, not with the idea of copying it literally, but to understand and appreciate its good points. So far as possible, we should be always endeavoring to do something different from what has been done before, and so moving forward with the times, but an intelligent knowledge and understanding of what has been done in the past will always help us forward.

TRIMMING FANCIES.

The trimmer will find in this account of novelties in the Olympia show something to keep him thinking and inventive:

Quite a novel effect in painting was achieved on a handsome limousine landaulette of the flush-sided pattern. The panels were of a biscuit fawn color, the belt and door rails being of a rich sea green. The interior color scheme was evidently the result of much careful thought, and harmonized with the exterior painting, down to the smallest detail. Light brown cord was employed on the seats, cushions and lower panels, the laces being artistically patterned in green on a background of the same shade. The upper panels and roof were trimmed in sea green cloth, and fittings of ivory and nickel gave the finishing touches to a very effective color arrangement. The driving seat was upholstered in morocco hide to exactly match the body color, and two folding seats were provided inside the car, turning up on the front panel. The luggage rail was painted to match the panels and was finished by a brass scroll.

Another limousine landaulette body was carried out in a new shade of cinnamon brown, to which a further touch of smartness was added by plain black mouldings, fine lined in chrome. The driving seat was upholstered in morocco hide of the same shade

of brown, and the pale grey of the interior trimming afforded a pleasing contrast to the rich tones of the panels—a contrast accentuated by the upholstering of the roof and upper parts in dark brown cloth.

In another the head leather was pleated in such a way that the top is rounded off on the back, the top corners from the back view harmonizing with the turn under the lower panels. Dark green morocco hide was employed in the interior, with laces to match, and two turn-up seats were fitted under the front light. In perfect keeping with the subdued coloring were the polished mahogany cantines and ivory fittings.

The cars were lighted by a central roof light, having a special reflecting globe, and another point of interest consisted in a narrow strip of brass attached to the bottom of the window frame on the outside, fitting over the striking plate. A clip was fixed to the plate on the inside of the frame, holding the glass string to the frame and fitting over the inside of the plate, thus preventing any possibility of rattle.

A limousine landaulette was painted dark blue, picked out in white, and upholstered in blue morocco. While everything had been done to make the body as light as possible, nothing which might add to the comfort or beauty of the vehicle had been forgotten. Especially was a luxurious appearance imparted to the driving seat by the broad squabbing on the elbow.

THEORY AND PRACTICE OF COLOR.

In theory harmony of color is simplicity itself, but in practice it generally proves quite a different matter. There is found to be something more necessary to make a good color scheme than a knowledge of theory. Pleasing work may conform to the accepted laws of color harmony, but it will be found that there is a good deal about such which is the result of something more than adherence to accepted laws.

One reason, says *The Painters' Magazine*, why theoretical color schemes are often unsatisfactory is because text-book authors generally deal with colors of normal intensity. When a red is spoken of the author has in mind such a red as vermilion, and in the case of green such a green as a middle chrome.

In actual practice combinations of full-toned colors are rarely satisfactory. The reason is that pleasing color schemes depend upon subtlety of balance and variation in tone values as much, if not more than, in true contrast in the matter of actual color.

It is known that tints which are made by simply reducing a normal color are never as pleasing as tints which are got by intermixing several colors. A pure full green or a pure tint of green is never as pleasing as a shade or tone of green. A chrome green, for instance, can seldom be used to good effect. It clashes with almost every other color with which it may be brought in contact. With a broken or subdued green it is different. This will harmonize with an almost unlimited number of color tones, because its composition gives it an affinity with almost all colors whether they be warm or cold primary, secondary or tertiary.

Owen Jones, the great authority on ornament, has said that no color scheme can be regarded as complete unless all the primary colors are present in equal proportions. This statement has often confused the student of color. It is, however, by no means difficult to grasp, and fairly accurately state broadly its first principles of good color.

The painter ought to aim more for delicacy of tone in color combinations rather than violent contrasts. In running lines or putting on stencils it is a common thing to see the painter use a striking color which in depth is quite out of keeping with the other colors used. Very good results may be got by simply stenciling the ornament in a color made by darkening the ground color, or the ornament may be in a soft contrasting color lighter or darker than the ground.

Strong colors for lines are suitable only, as a general rule, when the line is very thin, because a little of a strong decided color goes a long way. As a rule the larger the surface the

softer the color. Broad lines may be soft browns, whereas fine lines may be in crimson or some such decided color. It is a mistake to imagine that great contrast means great strength. Excessive contrast destroys the restful effect inseparable from good color work. Each tone in a color scheme should take its place and none be unduly obtrusive. A knowledge of a few simple principles together with care and judgment, will give, often with a trifling amount of labor, better effects than elaborate work, which involves a great amount of labor and materials.

REPAINTING A BUGGY, CARRIAGE OR AUTOMOBILE IN TWO DAYS.

First thing in the morning when you start to work is to unhang your job, and number same, then wash good all over top, and while job is drying clean the grease off of gear or chassis, then sandpaper your body well and give it a coat of roughstuff; then sandpaper chassis or gear and all their parts. Next give a coat of dark lead if painting is to be black. Mix keg white lead and dry lamp black together stiff with a little pale japan in mixture, no oil. Thin with turpentine and put on a heavy coat with a camel's hair brush smoothly. As soon as this is done glaze body all over with putty, clean up top and dress same if job has top on. After this is done give body another coat of roughstuff, then wait till noon and give another coat. The same night rub body out of roughstuff, sand or rub off with a rag. Give it a coat of solid covering color-varnish. The next day, in the afternoon, rub and finish with a quick-drying body varnish. For the gear moss off and smooth putty just the big holes, then give a coat of solid covering color-varnish first thing the next morning. Then moss and stripe and finish the same evening you do the body.

Get an easy-working gear varnish, one that will dry hard over night. If this is the only job you have you will have to do a little loafing, or work at something else. Time in which to do all we will say, ten hours; could be done quicker. Cost of time, \$2.50, stock, \$1.50; total \$4.00. Light buggy, \$8.00 for repainting this way. Carriage, \$9.00 to \$10.00; automobile \$15 to \$20. Stock for carriage \$2; for automobile \$3. Good price for stock. If one had plenty of work at these prices he could have it easy.

W. A. RIGGLEMAN.

A WHITE LEAD SUBSTITUTE.

A French patent has just been granted for a process of making what is claimed to be a harmless substitute for white lead. According to a description of it in the "*Manchester Guardian*," by mixing together equal quantities of saturated solutions of alum and carbonate of soda there is produced a white gelatinous precipitate of aluminium carbonate of the consistency of butter. After filtration the jelly is mixed, in the proportion of two-thirds or more, with finely powdered carbonate of lime, or magnesia, and rendered homogeneous by prolonged trituration. The product is dried in thin layers by moderate heat, and afterwards finely ground with linseed or poppy oil to the consistency of white lead. It is claimed that, like white lead, the substitute can be stored for a long time under water, and can be made up into paint with coloring matters and dryers. It is also stated that the paint lies with a gloss that makes varnishing unnecessary.

WOULD YOU DO IT?

Painters often have trouble in keeping the second coat of varnish from crawling away from the first, says *Practical Mechanics*, especially in cold weather. A simple remedy for this is to go over the first coat with benzine and allow it to dry before applying the second coat of varnish. The benzine leaves a gray film upon the varnish, which does not injure it in the least and causes the second coat to stick. To do a first class job of varnishing the temperature in the room should be about 65 degrees.

RUBBER COLLAPSE INJURING TRADE.

Consul-General Anderson, Honkong, China, says that the local trade in nearly all of the lower Chinese coast ports has been greatly interfered with by tight financial conditions, due to the collapse of several Chinese banks. The collapse of these banks has been due to the collapse of a number of inflated rubber companies in which many Chinese capitalists have speculated.

The movement toward the establishing of plantations for the cultivation of rubber in Ceylon, the Straits Settlements, and other portions of the tropical East, which has so interested British investors, has been particularly attractive to Chinese and Anglo-Chinese capitalists, as most of those concerned have been familiar with the country and with its rubber possibilities. Some of the best rubber estates are owned by Chinamen and much of the land which it has been planned to develop into rubber plantations has been in the control of Chinese capitalists from the South China ports, whence practically all of the Chinese to be found in the Straits Settlements, Ceylon, Java, and foreign countries generally have come.

Speculation in shares in rubber companies in the Chinese ports has been very active. When the inevitable collapse came Chinese investors and the Chinese banks which had loaned money on rubber shares suffered. In Shanghai several banks failed and the taotai, or district governor, used the credit of the Province to borrow money for the purpose of tiding over good but temporarily embarrassed concerns. Conditions in Canton were little better. In Macao, where there was an unusually large speculation in rubber shares, the situation has been very serious. Even Manila was affected by the general collapse. In Hongkong the trouble has been felt more indirectly but very seriously. There was not so heavy speculation before the crash and there has not been so violent a reaction, but the general financial conditions in the hinterland, brought about by the failures and monetary stringency, have been felt keenly here and several lines of trade have had their volume of business greatly curtailed. Cotton yarn, cotton cloths and similar goods are said to have suffered particularly.

ANTI-FREEZING SOLUTIONS.

The following anti-freezing solutions have been tried out and will be found efficient as low as the temperature given:

For 5 degrees below zero and upward, wood alcohol, 15 per cent; glycerine, 15 per cent; water, 70 per cent.

For 15 degrees below zero, wood alcohol, 18 per cent; glycerine, 18 per cent; water, 64 per cent.

Alcohol should be added from time to time as the solution is used up, and the formula broken by evaporation. If the motor is left running with the car standing idle this anti-freezing solution is quite likely to boil and evaporate rapidly.

The lubrication of the motor requires extra attention in extremely cold weather. When the mercury drops below zero a thin oil which does not thicken readily should be used. Extreme care should be taken to see that the oil in the lubrication system is not too thick to operate freely.

It should be remembered that gasoline does not evaporate as readily in cold as in warm weather. If the motor stands idle without protection until it gets cold, difficulty in starting may be experienced.

OWOSSO CO. IN RECEIVER'S HANDS.

The Owosso (Mich.) Motor Co, on December 6, asked for the appointment of a receiver and for the dissolution of the company. J. P. Waters, of Detroit, superintendent of the company, was nominated as receiver. The hearing will not be held until March 7. The dissolution is for the purpose of reorganizing on a more solid basis. The manufacturing of the light motor trucks will continue without interruption.

ANNUAL MEETINGS AND ELECTIONS.

At the annual meeting of the stockholders of the Champion Wagon Company, Binghamton, N. Y., the following were elected as directors: James A. Bassett, Henry C. Ripley, Edgar R. Cable, Jonas Shays and Theodore D. Gere.

The Marshalltown (Ia.) Buggy Co., held its annual meeting on December 20. The old board of directors was re-elected. The following officers were chosen: L. M. Osborne, president and treasurer; W. A. Tuttle, vice-president; Ray R. East, secretary. Mr. Kierulff reported the financial condition of the company in the best condition it has been since its organization. An amendment to the articles was adopted to the effect that the company may acquire and own stock in other companies.

At the annual meeting of the Goodyear Tire & Rubber Co., held in their Akron office on December 5, the following officers were re-elected: President and general manager, F. A. Seiberling; vice-president, Charles W. Seiberling; secretary, G. M. Stadleman; treasurer, Frank H. Adams; assistant treasurer, W. E. Palmer; superintendent, P. W. Litchfield.

The D. M. Sechler Implement & Carriage Co. held its annual meeting December 20 at Moline, Ill., and re-elected its old board of directors and officers as follows: President, Thomas M. Sechler, Moline; vice-president, J. M. Moon, St. Louis; secretary, A. T. McIlvaine, Moline; treasurer, O. M. Stowe, Moline; assistant secretary and general manager, W. J. Davis, Moline. The Sechler company has had a prosperous year. While there has been no extensive plant extension, the volume of manufactured product has been up to standard.

A CHEAP AND SIMPLE SCALE REMOVER.

The following is given by the author of a standard book on engineering: Sal soda, 40 lbs.; gatechu, 5 lbs.; sal ammoniac, 5 lbs. At one time I took charge of a boiler that was scaled very bad, and I did not find the sal ammoniac in town, so used the other two, and was not very particular about the proportion, either, with the result that in two weeks I had removed a large amount of the scale in large pieces, some of which were fully one-eighth inch in thickness. As I took feed water from overhead tank I would take off safety-valve and pour a few pounds of the mixture in boiler about once each week.

NOW A CAT. FACTORY.

After six months of chaos and mix-ups the Dundee Wagon Works, Crystall Lake, Ill., which went into the hands of a receiver early in the summer, after being declared bankrupt, has been purchased by the Montgomery Ward Company, of Chicago, and will be rebuilt with an addition, making the new plant twice the size of the present shops.

WAR TALK SHORTENS HOURS.

Wars and rumors of war in South America is ascribed by the Geneva (N. Y.) Wagon Company as the reason for operating its factory on short time. It has been receiving many South American orders, but it is said that conditions have become so acute that shipments are hazardous. Until there is an improvement in trade, the works will be run seven hours per day four days per week.

ALBANY CARRIAGE AND WAGON WORKERS.

Carriage and Wagon Workers' Union No. 59, of Albany, N.Y., recently elected the following officers: President, D. M. Fallon; vice-president, Joseph Muller; recording secretary, Theodore Kullman; financial secretary, C. S. Nellegar; treasurer, W. Pfeiffer; guide, Edward Keim; guard, Alonzo Smith; auditing committee, H. C. Milliman, E. Reissig, William Cameron.

ARGUMENT IN FAVOR OF TARIFF COMMISSION REVISION BY ITS FRIENDS.

Professor Emery's statement is "we cannot remake our tariff quickly and make it well." He states that it is a laborious task and that time is essential. The many schedules of the bill were encompassed in five months. This haste resulted in a bill which deluded the people, and which was unsatisfactory to the country.

There are many business men in this country who have been and are still in favor of a tariff commission, but it is an anomaly that many of these have been under the impression that an immediate revision of certain schedules is quite practical. Prof. Emery, however, says that this cannot be expected. He also says that a tariff commission cannot be of real value until it is a permanent institution. He has with great frankness discussed the pitfalls and dangers, but he just as frankly states that the ultimate result can be only for the general good.

The value of the tariff board cannot then be determined until sufficient time is given to demonstrate it. The five months actual work is proof positive that no just tariff rates can be made in that time. This, therefore, upsets the statement that the existing bill is as good as it should be.

Many will cavil at the tariff board's belief that compulsory powers are unnecessary, but many will be enlightened by the argument presented in this direction.

Compulsory examination might exist in the statute and it might be well to have it there, but it is doubtful whether a board or commission of the right calibre will ever enforce such a statute. The gentlemen of the present board state that they can get what they want without it.

Another statement is the value to commercial interests which a well compiled glossary of the facts would have, aside from the making and recommendations of rates of duty. This has long been needed in this country and should prove of importance.

The final conclusion is one that stands out boldly—this country needs a tariff commission, needs it permanently, and needs the kind of a tariff commission which Prof. Emery has so ably advocated.

The above is what Henry T. Wills, secretary of the National Tariff Commission Association, writes, and, of course, it is truly impartial.

FRENCH FACTORY FOR GOODRICH.

The Goodrich Tire Company has decided to manufacture in France. The European company has just secured possession of a large factory at Colombes, near Paris, recently vacated by the defunct Krieger Gasoline-Electric Company. A total area of 30,000 square yards is available, sufficient for a very large production. The new factory will probably be in working condition early in the spring and will be controlled by engineers and foremen from the Akron establishment. When in full working order it will supply the whole of the European market, comprising France, Italy, England, Germany and other outlying countries.

Freight charges will be avoided, as well as the high duty at present paid to bring American tires into most European countries. The company has had a selling branch in London for several years, and about three years ago opened a selling branch in Paris, primarily for the convenience of American tourists. Since then the business has grown to such an extent that the supplying of tourists is a mere side issue. In France the Goodrich company has had considerable success with the taxicab companies.

A BIG CONTRACT.

A big contract that covers a period of five years and is valued at \$2,500,000, has been closed by the Dayton Rubber Manufacturing Company, of Dayton, O., and the Dayton Airless Tire Company, of Chicago. The Dayton concern manufactures airless tires for motor vehicles.

W. H. RONINGER, PRESIDENT.

The last meeting of the year of the Implement, Vehicle and Hardware Association of St. Louis, was held Monday evening, December 19. The meeting was large, with an attendance of sixty members. It was also made the occasion of the annual election. The event was held in the Planters' Hotel. President Stevens and all the officers were present.

After dinner President Stevens called the meeting to order.

The matter of amending the by-laws of the association, to provide that the annual election should be held upon the regular meeting night of December, instead of in January, was taken up. The amendment was unanimously carried.

President Stevens announced election of officers for the coming year in order. J. D. Manley nominated W. H. Roninger, of the Banner Buggy Company, as a candidate for the highest position. The nomination was seconded by L. A. Geserich, of Moon Bros. Buggy Co. The nominations were ordered closed and the secretary was directed to cast the ballot of the association for Mr. Roninger. He was called upon for a speech, and responded in a few words of thanks. Then followed the election of the other officers, all being chosen unanimously.

First Vice-President—Geo. B. Ogan.

Second Vice-President—Carl Hirdler.

Third Vice-President—J. H. Murphy.

Fourth Vice-President—J. A. Geserich.

Fifth Vice-President—H. M. Hubbell.

Secretary—W. C. Howland.

Treasurer—Geo. M. Hoffman.

President Roninger said he would defer the appointment of the executive and standing committees until the January meeting.

GOOD TIME WITH BEEFSTEAK.

The Vehicle Manufacturers' Association of New York City is an organization of some of the active builders who meet as often as necessary, but always annually, when a dinner and entertainment are among the features. This year "The Vienna" in East 58th street has been selected and a beefsteak dinner is the novel attraction. It is the fourth annual occasion, and January 21 is the date. Generally the names of the committee of arrangements is the promise of what is to come. Those who know the following gentlemen will just be glad to be "among those present" at that dinner and what is to come after: O. J. Duhamel, chairman; W. H. Hoepfner, Thos. J. Clark, George MacBeth, Joseph Huber, Jr.

WAGONS BY MAIL.

Yielding to what they believe to be a strong tendency in all commercial lines the Kentucky Wagon Manufacturing Company, of Louisville, Ky., has completed arrangements to handle its output from the factory to consumer direct. The entire sales force of the company will be done away with and a catalogue business conducted. Among the reasons given for the change are the evil conditions which have grown up in the wagon trade, such as boycotting of factories selling their wagons to users in territory where they were not in dealer's stock, the giving of orders by unscrupulous dealers to factories for the purpose of keeping them from being sold to competitors, with the intention of countermanding orders before shipment can be made and "stool pigeoning" of wagons by keeping a few on hand to prevent competitors from handling them.

FINE NEW QUARTERS.

The Regal Buggy Company starts the New Year in a fine factory building at Eleventh and Howard streets, St. Louis. There are 80,000 square feet to occupy, and the company wants all the room.

IMPLEMENT AND VEHICLE ASSOCIATIONS.

The implement dealers in Western states have been very active in the matter of meetings, and the closing month of 1910 recorded a number of gatherings.

The **Iowa Implement Dealers' Association** called together something over a thousand men in Des Moines. W. J. Howard was re-elected president. Vice-President J. R. Vaughan was also re-elected. E. Geil was chosen as a member of the board of directors to succeed J. A. Johnston. E. P. Armknecht, secretary and treasurer, will be named again by the directory board.

The association is on record for the formation of local clubs throughout the state. The parcels post and excessive express charges came in for the customary drubbing. There was much said about cost-accounting, and it was suggested to the state fair authorities that a new machinery building on the fair grounds is needed.

The **Wisconsin Retail Implement and Vehicle Dealers' Association** occupied the auditorium in Milwaukee. Big attendance and much spirit shown. Robert T. Nash, of Grand Rapids, was re-elected president. L. H. Krause was elected vice-president, and George Ewen re-elected secretary-treasurer. The directors are: C. E. Borchardt, South Milwaukee; L. H. Krause, Port Washington; F. R. Sebenthall, Eau Claire; Otto E. Scherer, Palmyra.

The committees elected are: Legislative, F. R. Sebenthall, Arne Johnson, E. A. Ramm, H. Fesenfeld, Otto E. Scherer; harvester, J. W. Christensen, H. A. Schultz, M. H. Maridge, H. R. Brewer, E. J. Williams; conference, George Ewen, J. H. Miller, A. C. Fuge, J. C. Dana, Julius T. Knudson; resolutions, Arne Johnson, A. H. Prange, J. B. Watson; entertainment, Mr and Mrs. F. R. Sebenthall; Mr. and Mrs. Charles F. Schraeder, Mr. and Mrs. D. A. Allaby, Mr. and Mrs. Dan Smith, Mt. and Mrs. George Ewen.

The Wisconsin men are up in arms against the proposed prison twine factory at Waupun. Parcels post was hammered as a stock subject, and reciprocal insurance made its debut as a new subject. The Cost-Educational Association had its professor on hand to give the customary lesson on how not to "go broke."

This organization was formed in 1906 and has become a sturdy infant. In conjunction with the meeting an exhibit of implements was installed, and was a drawing feature. The entertainment feature was at the expense of the Manufacturers' and Jobbers' Association, and nothing was overlooked by the hosts.

Among the exhibitors we specialize: Racine-Sattley Co., Staver Carriage Co., Durant-Dort Carriage Co., D. M. Sechler Carriage Co., J. L. Clarke Carriage Co., Northwestern Manufacturing Co., Stoughton Wagon Co., Moline Wagon Co., Velie Carriage Co.

The **Dallas (Texas) Machinery, Implement and Vehicle Club**, at its regular monthly meeting, corralled the state attorney-general as its principal speaker. The lawyer said if all the hogs in the state were rolled into one big hog he could dig the Panama Canal without a grunt, and if all the steers were one, he could stand with his forefeet in Mexico and his hind feet would rest in Canada, brushing the aurora borealis with his tail. After this, the members felt they had been well advised as to the implement business!

President J. E. Ludlow announced standing committees for the year as follows: Grievance Committee, F. L. Shaw, A. P. Ten Brook, F. I. Glenn, C. H. Behrens, Hardy Greenwood; constitution, membership and by-laws, J. C. Duke, William M. Robinson, J. M. Wendelken, H. S. Keating, Stanley Crabb; legislative and freight, W. C. Lemmon, George A. Trumbull, George W. Pierce, C. E. Wells, C. L. Lake; auditing committee, H. P. Farr, LaMonte Daniels. W. I. Bogardus, E. Rosenbaum, O. P. Robb; printing committee, M. L. Sammons, J. F. Schoellkopf, R. A. Niccolls, Joe Rogers, C. S. Cave; entertainment committee, F. W. Warner, O. C. Youngblood, Charles Padgitt, A. B. Tabor, J. D. Harper.

The **Illinois Retail Implement and Vehicle Dealers' Associa-**

tion gathered in Peoria. Here also there was a large gathering of exhibitors showing their wares. The list of officers elected follows: President, William L. Derry; vice-president, J. F. Leuth; directors, A. B. Griffith, G. B. Leary, both re-elected, and A. Clevidence and William P. Morris. The office of secretary and treasurer is an appointive one. J. A. Montelius, Jr., was renamed for the office. The officers were entertained by the local implement and vehicle club, as one of the events of the meeting.

DATES OF DEALERS' CONVENTIONS.

Minnesota Retail Implement Dealers' Association, Minneapolis, Minn., January 10, 11 and 12.

Idaho Retail Hardware and Implement Dealers' Association, Boise, Idaho, Jan. 13 and 14.

Western Retail Implement and Vehicle Dealers' Association, Kansas City, Mo., January 17, 18 and 19.

Pacific Northwest Hardware and Implement Association, Spokane, Wash., Jan. 18, 19 and 20.

Colorado Retail Implement Dealers' Association, Denver, Colo., last week in January. (Subject to change.)

Southern Illinois and Missouri Retail Implement and Vehicle Dealers' Association, St. Louis, Mo., January 24, 25 and 26.

Oregon Retail Hardware and Implement Dealers' Association, Portland, Ore., January 24, 25, 26 and 27.

North Dakota and Northwestern Minnesota Implement Dealers' Association, Devils Lake, N. D., February 1, 2 and 3.

New York Retail Implement and Vehicle Dealers' Association, Rochester, N. Y., Feb. 2 and 3.

Retail Dealers' Hardware and Implement Association of Texas, Houston, Tex., February 14, 15 and 16.

TIMKEN-DETROIT AXLE CO. AWARDS PRIZES TO WORKMEN.

The Timken-Detroit Axle Co., has made the first distribution of awards to the foremen of the various departments of the plant for cleanliness and care of plant and equipment. Sixty-five foremen gathered in the offices of the plant at 4 o'clock Friday afternoon. A. R. Demory, vice-president and factory manager, gave a short talk on "Harmony and the Square Deal." W. H. Hutton, purchasing agent, distributed the awards as follows: First, \$25—drill press department, Ben Wilson, foreman; second, \$20—gear cutting and grinding department, Harry R. Huber, foreman; third, \$15—stock department, Charles R. Mumaw, storekeeper. Consolation prizes of \$5 each for excellence were awarded the milling machine department, Leonard E. Bauer, foreman; hub department, Herbert Clark, foreman; shipping department, John B. Nugent, Jr.; rough grinding department, Ben Fahindrich, foreman; front axle department, C. F. Gazley, foreman; tool room, Edward Searles. Every foreman received a box of cigars, and the foremen presented handsome gold fobs to Superintendent Weaver and Assistant Supt. Thompson.

CARRIAGES AND CARRIAGE STOCK.

A report from an American consular officer states that a firm doing business in the West Indies desires to be placed in communication with American manufacturers of hickory parts of carriages and vehicles, particularly wheels, carriage poles, axletrees, frames, and spokes, as well as of entire carriages.—No. 6004.

HAVE RAISED THE DOUGH.

The special committee having in charge the matter of raising the bonus to defray the cost of moving the Heaton Wagon Company's factory from Neosho, Mo., to Fort Worth, Tex., and the securing of subscriptions to the stock of the Texas company to the amount of \$50,000, says the task is completed.

CARRIAGE TO AUTOMOBILE MAKING.

The following from Long Island Motorist is a fair tribute to one of our really great builders, and we know the trade will be pleased to learn of facts that are so well stated:

Back in the year 1869 in Eighteenth street, New York, A. S. Flandrau, son of one William Flandrau, who began carriage building in New York in 1830, had begun to spell the word quality in carriage making. Even at this early date his work was the "last word" in his special line. Later he moved his business to Broome street.

In carriage building quality means convenience, comfort, stability, durability, graceful contour, beauty of color, refinement of design and a thousand and one other important things. It is a business that requires great accuracy of pattern and design. As the artist has found that the change of one line in the human face is sufficient to destroy a likeness, so the carriage builder has discovered that the slight change of one line may mean a difference between ugliness and beauty.

By the year 1877 A. S. Flandrau had so far succeeded in spelling the word quality into his business that his product had become widely known. The trade-mark "Flandrau" on a carriage meant a high-grade carriage. During the above mentioned year he sold his business to two men, Seth C. Keyes and Daniel T. Wilson, who with the foundation already laid by their predecessor, and through their own untiring endeavors, developed their business of carriage making to such an extent that Flandrau and Company became in a short time the largest retail carriage builders in the world.

Their product was sold to many of the best known men and families of their time. Grover Cleveland, William McKinley, and a long list of other well known public officials became their patrons. Many of the great financiers, industrial kings and men of affairs bought carriages bearing the trade-mark "Flandrau."

In the year 1893 Seth C. Keyes died and Daniel T. Wilson became owner of Flandrau and Company.

About the year 1895 an evolution in the manner and means of transit became apparent. Flandrau and Company, alive to the change that was taking place, were the first carriage makers of this country to build an automobile body. As the automobile craze developed they turned their attention more and more to the building of automobile bodies.

Arrangements were made with the Societe Des Automobiles Brasier of Paris, France, whereby they were to become the United States agents for this car, the bodies of which were built by Flandrau and Company. The Brasier automobile is very well known in this country and is one of the best known cars in Europe.

The Brasier chassis is a model of strength and simplicity. Sizes run from 10-12 H.P. 2-cylinder shaft drive, to 56-60 H.P., a six-cylinder chain drive; 12 models in all. In addition to these, the Brasier Company manufactures commercial cars with a front drive, which is very little seen in this country, but which in cars built for conveying heavy loads, is believed by some to have a distinct advantage over the rear drive type.

Flandrau and Company have unquestionably selected a chassis eminently in keeping with the high grade automobile bodies which they are manufacturing. A Flandrau body on a Brasier chassis is a very pleasing and effective combination, and Flandrau and Company believe the complete car is the finest car in the world.

Flandrau and Company now build very few carriages, but their business along the line of automobile building has developed very rapidly and is keeping their seven-story factory, store room and offices at 406 to 412 Broome street, New York city, very busy. Without question the name of "Flandrau" will be as well and favorably known to the coming generation as it has been to the last, as builders of high-grade vehicles.

ROSINA DANCED FOR THEM.

It would appear from the letter we shall append from the Weber Implement and Automobile Co., that the St. Louis Automobile Manufacturers' and Dealers' Association are partial to the spice of life, somewhat along the lines of the notorious Seeley dinner at Sherry's in New York, where the police took a hand as moral censors, not guests.

We suppose money comes so fast and easy in the automobile game that the exuberant spirit cannot be subdued within staid, commercial limits. Rosina, dear girl, for a consideration, is said to have done some very pleasing stunts before the guests in her birthday suit, so the following letter was received by the president of the association:

"Dear Sir: We hereby tender our resignation as members of the St. Louis Automobile Manufacturers' and Dealers' Association, and as reason therefor wish to state that this company will not lend its support, either morally or financially to any association which sanctions such entertainment as was furnished to those present at Saturday evening's banquet.

"We were lead to believe that the association had heard enough criticism in regard to previous banquets and that the entertainment Saturday night would be of a more elevating nature.

"No other line of business with which we have ever been connected can afford such criticism and censure as the affair of Saturday night deserves, and we are convinced that if the automobile industry is to become a permanent and staple business, the goal can only be reached by adhering to sound business principles. Until the association absolutely prohibits any form of entertainment which is debasing and degrading, we refuse to have the name of this company among its members. Yours truly,

"WEBER IMPLEMENT & AUTOMOBILE CO.

FREIGHT DISCRIMINATION.

The Milburn Wagon Works, Toledo, O., has preferred charges against the Lake Shore Railroad before the Ohio state examiner of the Interstate Commerce Commission. Edward Ryan, traffic manager of the Milburn Wagon Works, was the only witness examined. He testified that his company ordered a 36-foot car for Smithville, Texas; that the Lake Shore, having no 36-foot cars on hand, substituted a 45-foot car and compelled them to pay the full freight rates on that car.

DEEDED OVER.

The late Samuel Crossland's interest in the Crossland Carriage and Wagon Works at Uniontown, Pa., was transferred to the company.

NEW CATALOGUES.

Henney Buggy Co., (branch Moline Plow Company), Freeport, Ill.—A large, well designed, expensively and beautifully illustrated and printed issue fully representative of the work produced. We hope to show our readers examples in The Hub, which will be better than written description.

Freeport Carriage Co., Freeport, Ill.—A most attractive production, in colors. The taste shown in the catalogue as a printing exhibit is seen again in the lines of the work. The supplementary smaller catalogue of business wagons evinces the same high grade of effort and accomplishment.

Lull Carriage Co., Kalamazoo, Mich.—The 1911 product of a sterling shop, acceptably put forward between the covers of a catalogue that is second to none that has come under our notice.

Stevens-Duryea Co., Chicopee Falls, Mass.—One of the most interesting catalogs issued by any automobile concern. It seems from illustration and description that it is finally realized that a buyer is curious to know how the body is built as well as the power plant is designed; that comfort is quite as important as getting there.

WISDOM REMARKS.

Mr. C. M. Johnson told the truth to a body of implement dealers recently. It is a matter of no moment who the "dealers" may be, the truth should be absorbed by all who do a retail business. We select a few passages:

In looking over the lists of implement dealers from year to year, many have been startled, more have been surprised, and a few have realized that there must be some one main cause for at least an average of 25 per cent of the names changing every year on these lists.

Why does the average implement dealer who quits do so? Not from choice, but because it is a "woodchuck case."

Some dealers have made successes and their success has been so marked and pronounced that others "seeing their good works" thought they could do likewise in the same community, and entered their field.

Buying the goods was easy—selling them proved almost as easy, and in a year or two the new dealer scratches his head and tries to figure out where his original investment has gone, and where his big profits are. The more intelligent he is, the quicker he realizes that something is wrong and investigates. The result is he is forced to conclude that he has not figured all the expenses, all of the leaks, all of the donations, allowances, depreciation and gouges to which the average implement dealer pays a tribute.

Now, don't say that you know that your competitor is a price-cutter—he may be because he thinks that you are, and the result is that you are fighting each other and the farmer, your customer, is getting the profit away from you and you are not getting your share of the distribution of the value of the raw materials which produce the wealth of your community and vicinity.

About this time the National Federation of Implement Dealers appointed a committee to investigate and ascertain the percentage of cost of doing business. Letters were sent to dealers in every state and the answers received when tabulated showed that the average expense percentage figured on the gross sales was 17 per cent.

The answers showed, too, an alarming ignorance among the dealers as to how to figure cost and expense. It was decided to start an educational campaign to bring the ignorant dealers to the realization of what it really costs to do business. This was the formation of the National Cost Educational Association. One of the features of this association will be to bring to the attention of business colleges and business departments of high schools, the importance of educating the students, the coming dealers, to the expense of doing business, before a just price can be made for the selling of any goods.

You can not make a profit on an article unless you have added enough to the delivered cost to pay for all of the expense items, which form the bridge between the buying and the selling of the goods. No article should be sold unless it stands its share of the total expense and a fair profit.

How should a dealer figure his cost of doing business? One safe rule is to charge everything to expense that is paid out except the invoice price and the freight. Take the total of sales for the year, and the total expense for the same time, and divide expense by sales and you have the percentage of cost of doing business.

For example; sales are \$50,000, expense \$8,500, and this figured out would be 17 per cent for doing that volume of business.

In other words, for every dollar received, 17 cents was for expense, and 83 cents would be left to pay for the goods, freight and your profit.

These figures are considered a very fair average. If you have peculiar advantages and can cut down these expenses because your competition is not keen or you do not need to hustle, you should not cut down on the above in pricing your goods, but should get that extra profit stored away to offset the time which will come when you can not have conditions so favorable.

Should we figure interest on investment? Yes. Because, if you

do not you are cheating yourself. Couldn't you get 6 per cent on your money in farm loans if you sold out? Then you must charge that up to expense, because you lose it if you do not.

Rent on buildings, if you own them yourself? Yes. For you could rent them to some other fellow and get that income. Why not charge it to expense then? Salary for yourself? Yes. If you sold out and went to work for your successor, would you work as hard as you do now? Would you give him your best effort, all of your hours, for the salary mentioned? You couldn't work for another as you are working for yourself. Then charge up your salary to expense and pay it.

Advertising expense $\frac{1}{2}$ of 1 per cent? Yes. Spend it and your sales will increase—at least they will not fall off. This money is well spent. Dues in associations, trade papers, etc. This item is one of the best investments you make, but although it is an investment, you must charge it to expense, because the information derived does you much good, but is not an asset.

Apply this 17 per cent rule to your prices and see how you come out. A wagon costs you \$65 delivered—you sell it at \$80—your expense is 17 per cent of your sales, or \$13.60 on this wagon. You have \$66.40 left. Your profit on the wagon sale at \$80 is \$1.40.

A sulky plow costs you \$35 delivered, and you sell it for \$42.50. Your expense on this plow is \$7.23. Your profit on the plow 27 cents.

Riding cultivator costs delivered \$25.50. You sell it at \$32. Your expense on the cultivator \$5.44. Your profit 6 cents.

Now, these hints are for your benefit. Use them to advantage and see if you are coming out even and get the profits on each article or cut it out.

VEHICLE OUTLOOK BRIGHT.

General Manager Victor Beebe, of the Peters Buggy Co., Columbus, O., reports a bright outlook for the coming year. He says that specifications at this time are far ahead of the same time in any previous year. The company shipped out considerable stock during the month of December. Light vehicles having piano bodies and rubber tires are now the best sellers in the territory covered by Columbus buggy and carriage factories. Some of the factories are copying a certain line of automobiles in making their horse-drawn vehicles. J. W. Weston, advertising manager of the Columbus Buggy Co., Columbus, O., says the outlook for the coming year is good in every particular in both automobiles and horse-drawn vehicles.

CHANGE IN FULTON WALKER CO.

The Fulton & Walker Company, manufacturers of wagons, at Twentieth and Filbert streets, Philadelphia, Pa., has sold its business to J. Howard Wilson and Edward L. Craven, who will conduct the business under the firm name of the Fulton-Walker Company at the old address. Mr. Wilson has been general manager and secretary of the Fulton & Walker Company for 13 years and in the employ of the company for the past 20 years. Mr. Craven has been in the employ of the firm as superintendent for 16 years.

MRS. SARGEANT WINS FIGHT FOR ESTATE.

Augusta Mary Sargent, nee Hanff, stands to get \$20,000 from the estate of her husband, William W. Sargent, of Worcester, Mass., carriage dealer, by an agreement of the interested parties, whereby the Probate Court has disallowed his will, which gave her nothing, and the court appointed Attorney Charles H. Poor, Haverhill, as administrator of the Sargent estate. The estate of \$60,000 will now be settled as if there had been no will, the widow getting one-third, and Mr. Sargent's children by his first wife, W. S. Sargent and Mira Sargent, getting the other two-thirds.

WORKING PLANS OF WRIGHT AEROPLANE.

We heard a carriage builder say that he was prepared to build anything that came into his shop from a limousine to an aeroplane, and he added that he thought a carriage builder was the right man to build a flying machine as he could gather together more strength with lightness in woodstuffs than anyone. This seems a reasonable statement.

We have found in a foreign contemporary a very elaborate description of the Wright bi-plane with full working details expressed in metric measurements.

We do not give them here, but conclude a survey of the plans and working drawings may be of interest. If any proposition to create an aeroplane should come along, there would be a mind-picture of what such an affair was like as a sort of guide as to how to go at it. No use to give measurements in this case, as the plane shown is plastered with patents in all countries.

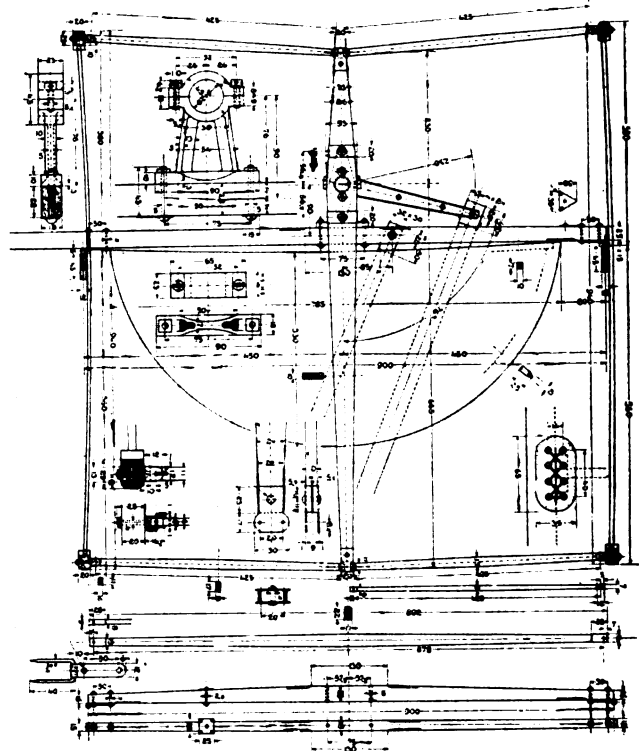

NATIONAL COMMERCIAL MOTOR CAR SHOW.

A comprehensive display of motor trucks, delivery wagons, and self-propelled road machines for all sorts of industrial purposes is to be held in Chicago during the week of February 6 to 11 next. It will follow immediately after the annual automobile show and will occupy the same building and be conducted by the same management, under the auspices of the National Association of Automobile Manufacturers.

It is estimated that upwards of 200 different models of work vehicles will be displayed. In addition the gallery and second floor of the annex will be filled with 150 industrial displays of parts, fittings and supplies pertaining to the motor car.

Power vehicles suitable for almost every kind of industrial and commercial business will be shown, from tricar parcel carriers for the quick delivery service of laundries, haberdashers, boots and shoe stores, confectioners, and other retailers of light goods, to ponderous motor trucks of five tons load capacity or more. There will be light and heavy delivery wagons, express wagons, baggage wagons, mail transfer wagons, light and heavy trucks from one ton capacity up, with open platform, stake, slat and covered bodies. Special forms for unusual purposes will be displayed, such as self-propelled chemical and hose carts for fire fighting, trucks with power winches operated by the motor that propels the vehicle for loading and unloading heavy pieces of machinery and boxes, crates and barrels; trucks with self-dumping bodies for handling building materials, ashes, etc., self-discharging coal trucks; patrol wagons, ambulances, sight-seeing cars and motor stages.

The forthcoming show offers an excellent opportunity for the business men to get posted upon just what these machines are accomplishing, and how they have been improved in recent years.

AUTOMOBILE KINKS.

A great many automobiles and motors have burned up by back firing through the carburetor. There is one sure remedy which was proven years ago in the invention of the Davy mining lamp, and that is by constructing a hood of fine gauze screen over the air intake of the carburetor, and to be further safe put a gauze cover over the exit of the muffler. It is impossible for any gas fumes to take fire through this protection.

FORD AND RAMBLER WILL EXHIBIT AT BROOKLYN.

Neither the Ford nor the Rambler will be exhibited at either of the New York automobile shows. Both will be exhibited at the forthcoming Brooklyn show. Preparations are being made to accommodate at least 150 displays. Members of the Brooklyn Motor Vehicle Dealers' Association are enthusiastic about the prospects.

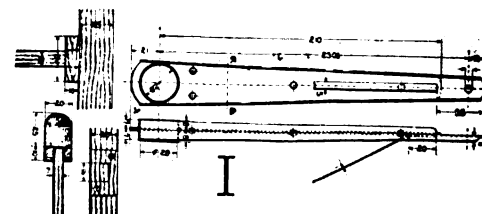
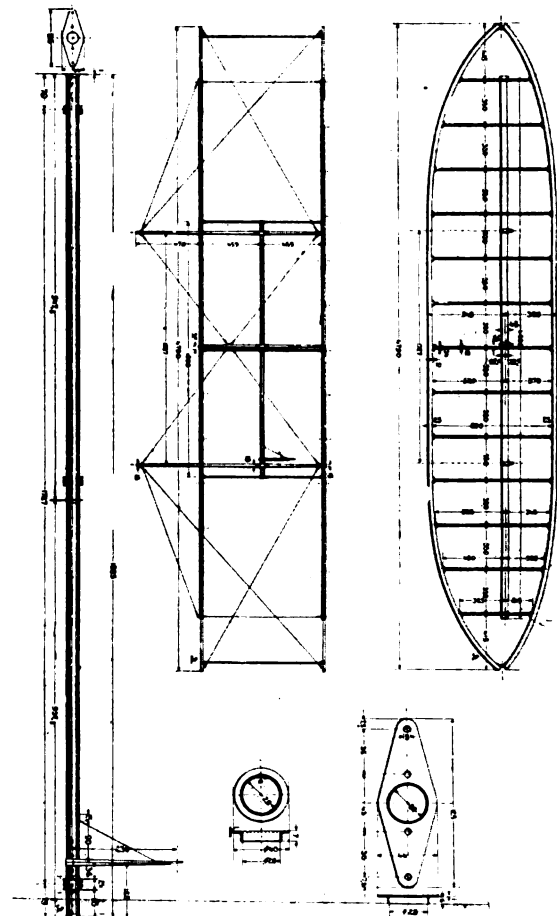

Trade News From Near and Far

BUSINESS CHANGES.

Carl Ream has purchased the King-Truax stock of buggies, etc., in Homer, Neb.

E. E. Cook, of Great Bend, Kas., has sold out his stock of vehicles, etc., to S. P. Bell.

C. E. Hass has purchased the vehicle business of Koenig & Shenk, in LeMars, Iowa.

A. J. Henbest, of Salhan, Colo., has sold his stock of vehicles, etc., to C. Schafer, of Hugo.

Marshall Bros. have purchased the stock of vehicles, etc., of Crum Bros., in Quenemo, Kas.

N. B. Clouse & Son have purchased the stock of vehicles, etc., of F. K. Pruter, in Natoma, Kas.

Henry Raucher has purchased the vehicle business of the W. S. Bosarth Co., in New London, Ia.

J. E. Moore has purchased the stock of vehicles, etc., of Benton F. Manning, in Lacrosse, Wash.

Mr. Botsford, Unadilla, Neb., has purchased the vehicle and implement business of A. J. Callaway.

Charles Logan has purchased the Van Deventer stock of carriages and harness in Panora, Iowa.

Price & Harlan have sold out their stock of vehicles, etc., in Libertyville, Iowa, to Coleman Foley.

W. C. McFayden has disposed of his stock of vehicles, etc., in Fullerton, Neb., to Frank E. Kenyon.

Hensley & Tucker have purchased the stock of vehicles, etc., of Steen & Buford, in Checotah, Okla.

DeVries & Schofield have disposed of their stock of vehicles, etc., in Roscoe, S. D., to Peter Malsom.

I. S. Rourke has purchased the vehicle and implement business of A. L. Wood & Co., in Conrad, Ia.

F. W. Sprung has disposed of his stock of vehicles and implements in LeRoy, Minn., to Daily & Boyd.

John F. Dackins has been succeeded in the vehicle business in Mankato, Minn., by Dackins & Litchfield.

T. H. Jackson has disposed of his stock of vehicles, etc., in Chilliwack, Ore., to A. M. Brockwell & Co.

Bert Hoover has purchased Gus. Lindelof's carriage works and blacksmith shop at Excelsior Springs, Mo.

Leslie Nichelsen has purchased the stock of buggies and implements of C. A. Mitchell, in Burchard, Neb.

Frank Foster has purchased the stock of vehicles and hardware of N. A. Myers & Son., in Thornton, Ia.

Godowski Bros. have disposed of their carriage and implement business in Platte Center, Neb., to Homer Robinson.

Meyer & Schleich have purchased the vehicle and implement business of Buckley Bros. & Co., in Caledonia, Minn.

The J. T. Carter Buggy Co., at Springfield, Mo., has been sold to F. W. Letsch, who with his sons will carry on the business.

A. E. Whitten, who has been in the carriage upholstering and automobile top business at Greenwich, Conn., has given up business.

Mr. Pflieger, wagon maker at Washingtonville, N. Y., owing to poor health, has given up business and gone with his son at Berwick, Pa.

Compton & Lilley, Troy, N. Y., have sold their stock of wagons, carriages, etc., and rented their shop to Lamont Berry, of Berrytown, Pa., who will take possession March 1. The firm of Compton & Lilley was established in 1873.

After nearly half a century of existence the Ledwith Carriage Company at Madison, Wis., has discontinued its business. James Ledwith established the business in 1863. Mr. Ledwith, Sr., died

in 1897 and the sons have managed the business until now when they have decided to retire.

John Mason and M. A. Luse have purchased the Dan R. Schnabel carriage works in Johnstown, Pa. The firm will be known as Mason & Luse. The new firm purposes to enlarge the carriage works and will also install an automobile trimming and painting department. A new paint shop will be erected next spring, when the present quarters will also be remodeled and improved. Mr. Schnabel will devote his attention to the sale of automobiles.

NEW FIRMS AND INCORPORATIONS.

T. W. Jay will establish a wagon factory in Leesburg, Fla.

Caffall Carriage Company, Beaumont, Texas, capital stock, \$20,000.

J. F. Hayes has opened a new stock of carriages, etc., in Linn Grove, Ia.

H. S. Bragg has opened a stock of vehicles, hardware, etc., in Albee, S. D.

J. G. Neighbors is opening a new stock of vehicles, etc., in Bayard, Neb.

Hillis Bros. have engaged in the hardware and vehicle business in Hollis, Okla.

E. L. Valentine is putting in a new stock of buggies, etc., in St. Johns, Mich.

Nelson Stebbins has opened a new stock of vehicles, etc., in Rapid City, S. D.

The Lake County Wagon Works is about to establish a factory in Leesburg, Fla.

Concord Carriage & Sign Painting Co., Pencook, N. H., has been incorporated.

The One Buggy Co. will establish a buggy factory in Suffolk, Va. B. F. Parker is manager.

J. A. Hanfit is about to construct a new vehicle and implement store in Columbus Junction, Ia.

F. L. Hodgson has engaged in the retail implement and vehicle business in Stewartville, Minn.

S. E. Tucker has opened a new store in Teague, Tex., and will handle vehicles, hardware, etc.

The Hannibal Wagon Co. has been incorporated in Hannibal, Mo., with a capital stock of \$55,000.

The Brown Buggy Co. has been incorporated in Hawkinsville, Ga., with a capital stock of \$10,000.

The Rutherford-Pninazee Co. has been incorporated to handle wagons, buggies, etc., at Juliette, Ga.

The T. A. Mercer Sons have opened a new stock of buggies, hardware, etc., in Chappell Hill, Texas.

The Hub Manufacturing Co. has been incorporated in Jonesboro, Ark., with a capital stock of \$25,000.

The Toombs Roller Bearing Wheel Co. has been incorporated in St. Louis, Mo., with a capital stock of \$50,000.

The Conder Vehicle Co. has been incorporated at Kershaw, S. C., capital, \$20,000, by W. C. Moore and Lewis Conder.

The DeBrular Mfg. Co. is the name of a new wagon making concern which will begin operations in the spring at Cornwall, Indiana.

Diamond Carriage Company, Spokane, Wash., capital stock, \$85,000. Incorporators: J. C. Mountain, S. S. Bassett and E. M. Aldridge.

The Pullaway Manufactory Company, capital stock \$30,000, has been incorporated at St. Paul, Minn. The company will manufacture sleds and wagons with a patented device. The in-

corporators are John Ritzinger, Albert H. Clark, Harry S. Clark and Victor J. Pinquet.

The W. J. Wood Co., Waterloo, Iowa, capital \$5,000, has been organized to manufacture buggies, wagons, farm trucks, grinders, buggy and wagon accessories, hay carriers, farm engines, drills, manure spreaders, pumps, etc. The officers are: President, W. T. Wood; secretary and treasurer, B. F. Swisher.

IMPROVEMENTS—EXTENSIONS.

The Anderson Wagon Shop at Salina, Kan., will build a \$1,000 addition.

G. E. Gunstead will erect a \$50,000 brick carriage shop at Spokane, Wash.

The new plant of the Hollingsworth Wheel Co., Hagerstown, Md., is in operation.

Milburn Wagon Co., Toledo, Ohio, is back in old quarters, after the repair of damage done by fire some time ago.

The Eller Wagon Works, of Houston, Texas, has filed an amendment to its charter, showing increase of capital stock from \$20,000 to \$40,000.

A. Z. Bulger, Martinsburg, Pa., purchased the old Lutheran Church, moved it onto his premises and moved his carriage shop into it.

The Storm Queen Buggy Company, which removed from Huntington to Wabash, Ind., a short time ago, will soon build additional buildings and increase its working force.

The Martin Wagon Works, York, Pa., is installing additional machinery. The factory is turning out a large number of commercial automobiles for local and out-of-town firms.

Charles Williams, Marion, Ind., has remodeled the interior of his hardware, buggy and harness store. He removed the elevated office at the rear of the main entrance room and placed it in the annex.

D. B. Dunham & Son, manufacturers of carriage tops, at Rahway, N. J., will erect a five story brick factory covering a plot 100x100 at Central avenue and Fourth street, Newark, at a cost of \$50,000.

The Noyes Carriage Co., of Elkhart, Ind., has purchased the General Manufacturing Co.'s plant and will equip it with new machinery at once, and hopes to have it in operation by the first of the year as an addition to its present plant.

Wm. Wiese & Co., importers of upholstery materials for automobiles and carriages, have removed to their new building, 234 West Fifty-fifth street, New York City. The quarters are commodious and perfectly adapted to the cloth business.

The Weber Implement and Automobile Company has moved from its quarters on North Main street, St. Louis, Mo., to the new location at Nineteenth and Locust streets. The building has been completely remodeled, a third story added, and is now modern throughout.

The Wright Carriage Body Co., Moline, Ill., has increased its capital stock from \$100,000 to \$150,000 and has installed a new dry kiln 150x20 feet, 100-inch fan kiln constructed of brick and concrete with concrete ducts for feed and return air currents, and the progressive system equipped with Sturtevant common-sense heater.

Within the next year the Findlay (O.) Carriage Company expects to more than double its output. From present indications more than 1,500 finished carriages and buggies will be turned out during the twelve months of 1911. The automobile branch of the industry will not be pushed during the next year, as all the time will be given to the carriage end of the business.

FIRES.

Gold & Weinberg suffered fire loss of \$1,000 at New Britain, Conn.

The carriage factory of William Ryan, Danville, Ill., was damaged by fire.

The warehouse of Geo. W. Peck, Bath, Me., was destroyed by

fire December 26. Fifty rubber tired carriages and many farm implements were consumed.

The J. S. Rogers Buggy shop, McDonough, Ga., suffered a fire loss November 29.

The Live Oak (Fla.) Carriage Factory was completely destroyed by fire December 10.

The Haywood Wagon Works at Madisonville, Ky., were destroyed by fire, December 22.

The stock of vehicles, etc., of Vaviness & Myers, Packwood, Iowa, has been destroyed by fire.

The stock of vehicles, etc., of Andrew Stroufe, in Imperial, Neb., has been destroyed by fire.

A. Ferrell & Sons will rebuild their carriage works in Dallas, Texas, which was recently burned.

Simpson's carriage works at New Kensington, Pa., suffered a \$4,000 loss in its repair department.

The William Mahle Wagon Co., St. Paul, Minn., suffered a \$5,000 fire loss December 2. Insurance \$3,300.

The Southern Carriage Works, Emporia, Va., were totally destroyed by fire December 5. Loss \$800, insurance \$500.

The Stiver Wagon Company's factory at Mill Hall, Pa., was destroyed by fire December 2. The company will rebuild.

The Baltimore (Md.) Hub Wheel & Mfg. Co.'s plant was destroyed by fire December 18. They will rebuild at once.

Rostand Wagon Works, at No. 9165 South Chicago avenue, Chicago, and five horses were destroyed by fire December 20. Loss \$10,500.

The building occupied by the Martinsburg (W. Va.) Vehicle Co., was gutted by fire December 2. Foundations for a new building across the street were under way at time of fire.

L. A. Bellis Carriage Company building and carriage establishment of Mr. Kline at Somerville, N. J., was destroyed by fire December 10. Forty wagons and two autos consumed. Loss \$10,000.

The plant of the Thornhill Wagon Works, Thornhill, Va., one of the largest of its kind in the south, was burned. Loss \$96,000, fully covered by insurance. At a meeting of the stockholders it was resolved to increase the capital stock from \$175,000 to \$300,000 and rebuild as soon as possible.

A fire followed by an explosion burned out the two top floors of Charles Barry's four story automobile and carriage shop at 254 East Fifty-seventh street, New York City in less than an hour. Three men were slightly hurt in getting out. Mr. Barry said that he thought his loss would be about \$40,000.

BUSINESS TROUBLES.

The Bourn Vehicle & Implement Co., Stevens Point, Wis., made an assignment for the benefit of creditors. P. H. Cashin is assignee.

Marvin Smith Co., mail order vehicles, Chicago, Ill., filed a voluntary petition in bankruptcy. Liabilities \$18,814.77; assets, \$26,074.12.

William B. Hilliard, El Paso, Texas, wheelwright, filed an application in voluntary bankruptcy December 7. His liabilities are \$4,405 and his assets are \$3,410.

William L. Wirshing, temporary receiver of the Buckeye Wagon and Motor Company, Dayton, O., bankrupt, filed his report in the district court December 2. It shows a balance of \$600 on hand. He was in charge two weeks and the Judge allowed him \$45 as compensation.

The sixth and final payment of dividends to creditors of the Harrison Wagon Company, Grand Rapids, Mich., was scheduled for payment December 10 by Trustee James R. Wylie and amounted to 4.9 per cent or \$21,000, or a total of 60 per cent on proved claims aggregating \$445,000.

The Jewel Carriage Company, of Carthage, which went into the hands of O. M. Blake and Charles F. Pratt as receivers last summer has been able to make such arrangements with all of its creditors that the receivership has been terminated. The com-

pany has increased its capital stock to \$450,000, \$400,000 of which is reported paid in.

Paul M. Burnett was appointed receiver for W. L. Jackson, trading as W. L. Jackson & Son, and the Monumental Carriage Company, Baltimore, Md., December 7, by Judge Morris, in the United States District Court. The receiver was appointed on the petition of Anna J. Ireland and Helen B. Abbott, of St. Louis, Mo., who claim that the company is indebted to them for \$2,000 and \$1,000, respectively.

Suit for \$20,000 damages has been instituted by William G. Isbell against the Anderson Carriage Co., manufacturers of the Detroit Electric automobile. Isbell alleged that he made a contract with the defendant concern to act as selling agent for five years, but says the contract was broken, and as result he lost large profits. The defendants claim that Isbell did not produce the results he promised.

INCORPORATIONS IN THE AUTO TRADE.

- Detroit, Mich.—Chief Motor Car Co., capital \$200,000.
 Detroit, Mich.—Thelma Motor Works, capital \$10,000.
 Kansas City, Mo.—Cino Auto Co., capital stock \$10,000.
 Detroit, Mich.—McIntosh Auto Co., capital stock \$10,000.
 Pierre, S. D.—Cure Motor Car Co., capital stock \$125,500.
 Detroit, Mich.—Ideal Commercial Car Co., capital \$10,000.
 Cleveland, O.—Hewitt Motor Truck Co., capital stock \$10,000.
 Youngstown, O.—Kelly Automobile Co., capital stock \$15,000.
 Cincinnati, O.—Imperial Motor Car Co., capital stock \$150,000.
 El Paso, Tex.—Western Motor Supply Co., capital stock \$6,000.
 Omaha, Neb.—Marion Automobile Co., capital stock \$15,000.
 Washington, D. C.—Gyro Motor Co., capital stock \$100,000.
 San Antonio, Tex.—Bangor Motor Car Co., capital stock \$16,000.
 St. Louis, Mo.—Woods Electric Vehicle Co., capital stock \$25,000.
 Mobile, Ala.—Bienville Automobile & Garage Co., capital stock \$2,000.
 Bluefield, W. Va.—Mercer County Automobile Co., capital stock \$10,000.
 Milwaukee, Wis.—Cream City Auto Co., capital \$5,000, by H. E. Rogers, Carl Staum, W. J. Surres.
 Detroit, Mich.—Crowe Motor Car Co., capital \$100,000, by W. E. Crowe and William W. McIntyre.
 New York—Safety Tire Co., to manufacture tires for automobiles, capital \$50,000, by R. H. Schenk and others.
 Milwaukee, Wis.—Mickelson Motor Co., capital \$30,000, by F. M. Mickelson, J. A. Mickelson and G. A. Mickelson.
 Chicago, Ill.—Lalor Wagon Co., vehicles, autos, etc., capital \$200,000, by M. W. Lalor, D. K. Lindout, J. C. K. Lindout
 Plano, Ill.—Dewey & Co., autos, electric goods, vehicles, etc.; capital \$5,000, by H. M. Dewey, E. E. Gray, B. A. Kinney.
 Whitehall, Wis.—Auto Sales Co., capital \$8,000, by R. S. Cowil, G. S. Rice, P. M. Lambert, W. L. Lambert, C. B. Melby.
 Wilmington, Del.—The Detachable Wheel Co. of America, capital, \$50,000, by W. N. Akers, M. C. Taylord, W. H. Maloney.
 St. Louis, Mo.—Chicopee Motor Car Co., capital \$3,000; by Harry C. Carr, F. E. Carr, to manufacture and deal in automobiles, etc.
 New York—Ward Motor Vehicle Co., to manufacture motors, engines, machinery, etc.; capital \$200,000, by C. A. Ward, W. B. Ward, L. S. Kafer.
 Rochester, N.Y.—Rochester Accessory Mfg. Co., capital \$3,500, manufacture and sell automobile accessories, by Max L. Adler, Milton S. Adler and others.
 New York—Strapless Tire Holder & Trunk Co., to manufacture automobile holders for tires and trunks; capital \$10,000; by B. A. Alperin and M. F. Tobias.
 Chicago, Ill.—Ames Motor Car Co., capital \$25,000, general automobile and manufacturing business; by Vincent Bendix, William W. Loomis, Matthew Mills.
 New York City—Stern Motor Co., to manufacture motors,

engines, vehicles, machinery, etc., capital \$100,000, by F. M. Randall, P. K. Stern, L. Ronsenberg.

Brooklyn, N. Y.—Tire Chain Patents Co., capital \$25,000; incorporated by E. E. Holmes, A. W. Britton, New York City, to manufacture non-skidding auto chains, etc.

Salt Lake City, Utah—Arvis Motor Co., to manufacture and deal in motors; capital \$25,000, by Reinold V. Smith, J. Fewson Smith, Joseph V. Smith and Archibald C. Milner.

Chicago, Ill.—Multi Manufacturing Company, capital \$100,000, to manufacture and deal in automobiles, parts, accessories, etc., by G. W. Beyers, M. M. Freiberg, H. A. Caperton.

PERSONAL.

P. A. Elsesser, general manager of the Martin Carriage Works, has been elected president of the Manufacturers' Association, of York, Pa.

The employes of the Champion Wagon Company, Owego, N. Y., presented David E. Noonan, who was injured at the shops, a handsome purse of money. Mr. Noonan has been employed there for a number of years.

Eric F. Sangreen, who designed the commercial car now being manufactured by the Oliver Motor Car Co., has rejoined the forces of the Grabowsky Power Wagon Co., Detroit, Mich. Mr. Sangren's former experience with the Grabowsky people makes him a potential factor in their mechanical corps.

Harry E. Field has resigned from the positions of vice-president and general manager of the Hartford Rubber Works Co., Hartford, Conn., to become president of the Rambler Automobile Co. of New York, which is the eastern branch of the Thomas B. Jeffrey Co., Kenosha, Wis. Mr. Field will have the management of the Jeffrey interests in all of the territory east of Buffalo and Pittsburg.

H. H. Bassett, who has been foreman of the body paint department of the Freeport (Ill.) Carriage Company for the past year, has returned to his former home in Pontiac, Mich., where he will engage in business for himself. As a token of esteem the men under his supervision presented him with a pair of gold cuff buttons. The buttons contain an Elk head and were set with diamonds.

The Auburn Wagon Co., Martinsburg, W. V., has lost a valuable man in Mr. S. R. Snodgrass, assistant treasurer and sales manager for the past ten years, who, for reasons of health, will locate permanently in Colorado, starting for his new home January 1. Mr. Snodgrass, who has been actively identified with the business and favorably known to the trade in the East, carries with him the good wishes of all his many friends in and out of the company.

W. C. Nones, president of the Kentucky Wagon Works, Louisville, Ky., and who was a pioneer in the movement in Kentucky in the fight to check and stamp out the ravages of tuberculosis, was given a testimonial by those who appreciate his good offices in that regard. The token was in the nature of a dinner, at which Mr. Nones was supreme guest of honor. The function took place at The Seelbach December 20. Invitations were sent out to about sixty persons, men and women who most appreciate Mr. Nones' work. He is shown to have given liberally of both his time and money to the work of fighting the "great white plague," and to the institution in Louisville which is now recognized as one of the city's greatest philanthropies.

PARRY AUTO CO. PLANS.

Creditors of the Parry Automobile Company have practically agreed to ask the Superior Court to authorize the operation of the plant by the Union Trust Company, receiver, and to authorize a limited issue of receiver's certificates for the purpose. After this is done it is probable the receiver's will organize a holding company to take over and operate the plant until the indebtedness has been removed.

OBITUARY

Edw. Keys, secretary and treasurer of Keys Bros., Inc., manufacturers of carriages at Council Bluffs, Ia., died after an illness of several months.

Henry J. Miller, Jr., aged 34, half owner of the Goshen (N.Y.) Cart Co., died December 8 at Passaic, N. J. He is survived by his parents who reside in Passaic.

Jacob Miller, for many years the owner of a wagon shop in Clayton, Ill., committed suicide in the cellar of his children's home in Los Angeles, Cal. Mr. Miller was 81 years old. He leaves a widow.

James Nellis, 85 years old, died December 16 of organic heart trouble in Chicago. He was formerly a carriage manufacturer in Mendon, N. Y. His wife died twelve years ago. He leaves a daughter and a granddaughter.

George O. Cruttenden, 82, for many years a carriage manufacturer in New Haven, Conn., died December 6 of a general breaking down. He was associated with Eliphalet Killam in the carriage business for over 50 years. Mr. Cruttenden retired in 1899. His wife died less than a year ago.

William P. Koehler died at his home in Buffalo, N. Y., December 5, after a lingering illness. He was born in Lancaster 45 years ago and moved to Buffalo more than 30 years ago. For many years he was engaged in the wagon manufacturing business, retiring about six months ago on account of declining health. Mr. Koehler was prominent in social and political circles. Surviving him are his wife, Anna Koehler, and three children.

Richard A. Haegelin, a resident of St. Joseph, Mo., for thirty-seven years, died December 24, after an illness of four months. Deceased was born in the grand duchy of Baden, Germany, January 13, 1836. As a boy he came to the United States, but returned to his native land at maturity. In 1873 he moved to St. Joseph with his family and established a carriage and wagon factory, the firm being Prawitz & Haegelin. Both members of this firm are now dead. He is survived by his widow and two children.

Charles E. Chalker, of Chalker & Fenn, carriage manufacturers, Meriden, Conn., died December 5 from injuries received in falling from a third-story window while delirious from sickness. He was fifty-one years old. His wife died several years ago. Two children survive, also his father, Walter J. Chalker, for years in the carriage business in Meriden, now living in New Haven, and three brothers. Mr. Chalker took up his father's interest in the carriage business six or seven years ago when the elder Chalker retired.

William Thomas Jones, who passed to the majority on November 29, after seventy-seven years of a most useful and honored life, was one of the best known and esteemed associates of carriage builders the country over. As a long-time president of the southern carriage builders' organization his work and influence was made manifest all through the South. He was president of Tyson & Jones Buggy Co., of Carthage, N. C. It was at that city he passed away. His hospitality in his charming home will be remembered for years by sorrowing business and social friends.

Joseph D. Myers, aged 72, senior member of the firm of Myers & Van Duyn, carriage manufacturers, Springfield, Ill., died December 13. He was born in Leipsiz, Germany. His first employment in Springfield began with Allen Miller, who conducted a carriage factory in 1860. Shortly afterward he bought out the business and later entered a partnership with William Talbott, continuing until the latter's death, when he entered a partnership with H. B. Davidson and George Henley, under the firm name of Myers, Davidson & Henley. After the dissolution of this firm, the partnership of Myers & Van Duyn, which has continued for twenty years, was formed. Walter S. Van Duyn is the surviving

partner. Mr. Myers had been prominent in local politics. Surviving the decedent are his wife, two daughters and a son.

August Weber, 68 years old, a retired wheelwright of Baltimore, Md., was found dead in bed at his home, December 27. Escaping gas from a defective heater had partly filled the room, but after a careful examination the coroner found that his death was due to natural causes. He had been in ill health for several years and suffered from kidney trouble. He was to have undergone an operation. Mr. Weber was born in Germany and when a young man came to this country. He settled in South Baltimore, where he lived all his life. For forty years he engaged in building wagons, retiring seven years ago on account of ill health. He transferred his business to his nephew, C. Henry Schaab. His wife died two years ago.

Wm. H. Baldwin, aged 76, died December 19 at the home of J. Scott Thompson in Glen Ridge, N. J. In 1858 he entered the employ of Phineas Jones, manufacturer of carriage wheels, whose business was then located at Elizabethport, N. J. Shortly afterwards the business was moved to Newark, and in 1859 Mr. Jones and Mr. Baldwin formed a partnership under the name of Phineas Jones & Co. Phineas Jones died in 1884 and the business was thereafter continued by Mr. Baldwin and Henry P. Jones. Mr. Baldwin retired from the business in December, 1896, and was not afterwards engaged in active business. He was prominent in business affairs, and was president of the Newark and Orange Horse Railway Company, while that property was controlled by the Pennsylvania Railroad. He was a director of the Merchants' Insurance Company of Newark from its organization until it went out of business a few years ago. He represented the second ward in the Common Council from 1871 to 1876. His wife died three years ago. He is survived by two sons, Oscar H., of London, England, and Raymond S., of New York, and two daughters.

TO MAKE VALVELESS ENGINE.

The Evans Motor Car & Parts Co., Detroit, Mich., is preparing to put on the market a car incorporating the two-cycle motor controlled by the English Valveless Engine Co. A large plant will be put into commission as soon as the final details have been arranged, and the manufacture of cars and motors will shortly be undertaken on an extensive scale.

MOTT WORKS INCREASE STOCK.

The Mott Wheel Works of Utica has certified to the Secretary of State that the amount of its capital has been increased from \$50,000 to \$150,000, consisting of shares of \$100 each.

INSURANCE COMPANIES RAISE BAN.

Insurance companies have withdrawn the restrictions whereby gasoline trucks were denied admittance to steamship piers in New York City.

RECENTLY EXPIRED PATENTS OF INTEREST TO THE VEHICLE INDUSTRY.

Patents Expired November 14, 1910.

508,612—Vehicle Brake. Patrick J. Hanley, Amesbury, Mass.
508,832—Vehicle Brake. Stephen E. Odell, Grayling, Mich.

Patents Expired November 21, 1910.

509,009—Hub-Attaching Device for Vehicle Axles. Herman Wecker, Offenbach-on-the-Main, Germany.
509,063—Automatic Wagon Brake. John Wennberg and Ole Lindstrom, Fertle, Minn.

509,069—Vehicle Spring. George C. Burch, Westerly, R. I.

Patents Expired November 28, 1910.

509,354—Wagon Running Gear. James H. Baker, Allegheny, Pa.
509,542—Attachment for Vehicles. Orris W. Mason, Buda, Ill.
509,809—Vehicle Wheel. Calvin J. Holman, Chicago, Ill.

Patents Expired December 5, 1910.

509,876—Wagon Spring. George T. Chapman, New York, N. Y.
509,975—Vehicle. Horace S. Van Patten, Manlius, N. Y.
510,203—Vehicle Wheel. Nathan Smith, Great Harwood, and John Haydock, Blackburn, England.

The above lists of patents, trade marks, and designs of interest to our patrons are furnished by Davis & Davis, solicitors of American and foreign patents, Washington, D. C., and St. Paul Building, New York City.

Grand Central Palace Show.

The Velie catalogue says: "Follows the conventional lines that are standard for this car." This in a nutshell explains the whole show. Everything was "conventional."

The product offered was in all respects good in its way and class. The prices were reasonable for the quality offered, the quality was reasonable for the class of work shown.

This show comprised those exhibitors who consider the Selden patent as something of no moment as a tribute compeller. They are just perfecting an organization, (mentioned in detail elsewhere in this issue) that will classify the builders as outside the breastworks of their own volition.

A noteworthy fact was the number of well known vehicle builders who are entering the self-propelled department. The Cunninghams, of Rochester, the Coles, the Velies, the Michigan Buggy Co., Columbus Buggy Co., the Cortland Wagon Co., the Schacht Co., Cincinnati, Geneva Wagon Co., Gramm Motor Car Co., and a list of names that it is of no especial interest to mention, unless we wished to catalogue the exhibitors, which is no part of the intention at this time, and in this notice. During the year we may have the pleasure of showing many of the vehicles which will be better than a mere description.

In some instances the power plant was developed in the factory of the builder, in others it was purchased, therefore assembled. It was mainly featureless except that it was indicative of the good features of anything that could be used that had previously been the product of the brain of some originator who had given it a name because of original thought. This is good for the buyer because he is getting the consensus of all the so-far best engineers. The buyer wants ability, not new thought. The wholesale buggy was developed this way into good and cheap—a product of great usefulness to the community. The motor car is now beginning to follow the lines that will make it a wonder of low price, and quality for the price, in the near future. The carriage builder will do the stunt.

Velie had a rather large display. Good selection of styles, Trimming and painting attractive for the trade for which the work is made. First class dealers' proposition, and deservedly popular.

The Cunninghams have been for so long a time makers of good grade heavy work that they were naturally at home in limousines and any other kind of body proposition. The finish and trim are most pleasing. Nothing original in body design, nothing was looked for. But the work would do what was expected of it and do it well.

There were some examples of friction drive transmission, on pleasure and commercial work. Excellent device for the stupidly disposed; wonder it is not more generally employed as machinery stupid's predominate.

There was one example of the single cylinder. It was labelled as the "Only Car." No name of builder, and no pretence at a "show," as it was a common, used body. The idea was to concentrate attention on the power plant. It was a 12-horsepower engine according to the official rating, but as the stroke was 5 inches, it seemed to us that 30 horsepower would be nearer the truth. However, if the claims set forth by the demonstrator, are verified in use, it will cut quite a few coupons for its distributors. The right kind of a single cylinder is going to be somewhat in the spot-light before long.

A Motorette made in Hartford, and sold for \$350 was one of the attractions. It has two wheels forward, and the driving wheel in the rear. Accommodates two passengers in comfort. By a quick change in front of the dashboard a parcel carrier may be put on of 250 pounds capacity. The motor is of two-cycle,

two cylinder type. It has the rotary valve arrangement for the admission of gas to the crank chamber. This is good practice abroad to-day. Chain drive. Body and frame of one-piece pressed steel. All the details are composed of worthy material good for hard work. It can be equipped with all the "tricks," such as wind shield, etc. It is in every respect a much more stable vehicle, and will do what it does better and more comfortably than a certain one-lunger that is sold for something over one hundred dollars more, and which is cheap and meretricious in all its details.

Our German friends also had a three-wheeler, but just reversed the motive power to the front single wheel. It also could be used as a package delivery or a pleasure car for two or three passengers. The frame and body of steel, and the control from the steering handle. It is \$900 worth of good car.

Still another good little car was one built in the town near Boston where watches are made. This car displayed some of the ingenuity of the machine-made watch, and was fine value for the \$485 asked. It was of the two-cylinder, opposed, offset kind, and had about all the essentials of the big brother, combined with great simplicity. By reversing the wheels on the axle, the tread can be changed from 81 to 84 inches at will. It is friction drive, chain to wheels. The same concern had the engine rigged up on runners with a propeller, aeroplane model, on the engine, and with this it had an ice sled of practical use, so said.

It is not worth while to specify any more pleasure vehicles, as we have given the novelties and the main characteristics.

The commercial cars made quite a showing. All sorts of prices and models. The gem of the collection so far as the character of the work on the chassis and the engine goes, was without doubt, the one that originated in Switzerland and that is seen about the city run by those able to afford the price.

The Gramm Motor Car Company, of Lima, Ohio, had a comprehensive display, its trucks being built of one, two, three and five-ton capacity. The one-ton has a four-cylinder en bloc motor of 4 by 5, the power plant being a unit system and the oiler self-contained in the motor. The clutch is a multiple disk and the cooling system is thermo-syphon. Drive is by chain and the weight is about 2,800 pounds. The wheels are 34 by 3½. The motor on the two-ton truck also is a four, but the cylinders are cast in pairs and have a bore and stroke of 4¼ by 4½ inches, the mechanically operated valves being on one side. A gear-driven pump is found in the cooling system and the gearset is selective sliding. The clutch is a multiple-disk and the wheelbase 124 inches. The three-ton motor has a bore and stroke of 5 by 5, a wheelbase of 124 inches and a tread of 66. This same motor is used on the five-ton trucks and in general detail is about the same. The wheelbase is 130 inches and the tread 69.

The Martin Wagon Works at York, Pa., had a good exhibit of light and heavy work. Nothing novel, just good, honest, lasting work.

The Penn-Unit had some good quick-demountable features. By removing two bolts the unit could be drawn forward and detached from car. We have in previous issues described such a feature designed by the originator, Mr. Twombly. This is along the same lines. The body models were very neat and served the intended purpose.

Some of the work struck us as flimsy in some of the cars intended for heavy service. There was a leaning toward the high wheel that was most commendable as a useful design, and some solid tires were in evidence. All the motor power plants depended on some little refinement of construction of the particular maker, that he had added as his particular contribution to per-

fection. Many of the engines were of the air-cooled type, and mostly direct opposed, especially in the lighter classes.

The best novelty we saw was one the work of the Cortland Wagon Company, the product of the ingenuity and engineering skill of young Mr. Duffy. By a simple, almost automatic brake and clutch arrangement the action of the foot alone would brake, and when braking throw out the high gear by the one foot-motion, while the reverse could be set at the same time. It superseded the side levers, and doesn't even require brains in the feat to be always right in case of quick action or emergency. It was the best device in the show, and ought to be on every car to ward off the foolishness of the fool, or the rattle of the rattled.

Space does not allow of any further comment at this time.

THE INDEPENDENTS ORGANIZE.

The automobile show at the New York Grand Central Palace closed with the exhibitors fused into an organization, the first step being taken January 6. The following is an account of what was done.

The new independent body has come out with the flat declaration that it intends to be a militant, aggressive force in the motor car industry of the United States. The formation of this organization, the name of which cannot be known until the incorporation papers are returned from Albany, is an important move in the automobile business and is of significance to dealers, also the smaller makers of cars.

The directors chosen are as follows: Carl F. Johnson, Johnson Service Company, of Milwaukee; W. S. Jones, Otto Motor Car Sales Company, of New York; Thos. Aldcorn, of the Chicago Pneumatic Tool Company; W. J. Mills of the H. H. Babcock Company, of Watertown, N. Y.; Col. T. A. Campbell, of the Imperial Automobile Company, Jackson, Mich.; Louis J. Bergdoll, of the Louis J. Bergdoll Motor Car Company, Philadelphia; H. C. McFarlan, of the McFarlan Motor Car Company, Connerville, Ind.; C. W. Kelsey, of the C. W. Kelsey Mfg. Co., of Hartford, Conn.; E. W. Hommel, of the Clark-Norwalk Motor Car Company, S. E. Baily, of the B. C. B. Motor Car Company; Counsel, Frank Harvey Field, New York.

The nucleus of the new organization consists of thirty charter members. Officers will be elected after the incorporation has been effected. The association will in all probability establish permanent offices in New York in the near future where a staff of system experts will handle the details of the plans the new organization is to carry out. It is expected that fully a hundred independent makers will join the association within the next six months.

The association declares that it will protect dealers and the smaller makers of cars from the undue influences brought to bear on them in the trade, that it will prevent discrimination, hold an annual show at New York, and has already obtained an option on the New Grand Central Palace Building, which is to be the largest and finest exposition hall in the United States.

CROXTON COMPANY HAS REORGANIZED.

The Croxton Motor Co., of Massillon, O., has purchased all of the assets of the Croxton-Keeton Motor Co. The new company has a capitalization of \$250,000 and is planned by New York capitalists. The plant has been in continuous operation under the receiver, and starts operations with a complete organization. The new officers are H. A. Croxton, president and general manager; J. P. Stoltz, vice-president; H. D. Michaels, secretary and treasurer, and W. F. Melhuish, who needs no introduction to the trade, will have charge of the sales. The product for 1911 will be confined principally to the 25 horsepower French type car with sloping hood and radiator on dash. These will be made up in roadsters, five and ten passenger cars, landaulettes and taxicabs.

THE AMERICAN MOTOR IN ENGLAND.

Mr. Ingram, our consul at Bradford, has been looking up automobiles, and we condense some of his observations for those who are interested in the movement of the trade:

The demand for automobiles is constantly on the increase, and while the area of Great Britain is comparatively small the number of motor cars in use is proportionately greater than in any other part of the world. A motor journal recently gave the number of automobiles registered in the United Kingdom as 203,227.

The trend of public opinion in regard to design and horsepower seems to vary from time to time, and at present the latter question is coming to the front, partly, no doubt, owing to the recent legislation raising the annual tax on motor vehicles which formerly stood at £2 2s (\$10.21) or £4 4s (\$20.43). The present method of assessment is based on the horsepower of the engine, calculated according to the Royal Automobile Club's rating on the square of the internal diameter of the cylinder, $2\frac{1}{2}$ square inches equaling 1 horsepower.

This affects the high-powered cars adversely and manufacturers, who are always catering for the actual requirements of the public, are turning their attention more particularly to the medium and lower horsepowers. As an illustration of the decrease in the value of the high power cars, quite recently advertisements appeared in the trade journals offering for sale one 70 horsepower at £175 (\$852), three of 60 horsepower at £150 (\$730), £275 (\$1,338), and £425 (\$2,068), and two 50 horsepower cars at £100 (\$487) and £300 (\$1,460). Of the last named one cost over £1,100 (\$5,353). All these cars were declared to be in good condition.

The result of the assessment of duty on the bore of the cylinder alone is that constructors have been induced to build motors with longer strokes, thereby increasing the horsepower. A striking illustration of this is shown in a new motor by a leading French firm which has a bore of 100 millimeters and a stroke of 300 millimeters. Under the Royal Automobile Club's rating this would be liable to duty as "not exceeding $6\frac{1}{2}$ horsepower," whereas it will develop 35 horsepower.

Great improvements have been made in the construction of engines of late, and their pulling and accelerating qualities are such that they are capable of doing the work formerly necessitating a much larger engine. One of the most popular sizes now called for ranges from 15 to 20 horsepower.

There still remains a certain amount of prejudice regarding American productions, caused by former importations having failed to come up to the standard claimed. This prejudice must be overcome, which will naturally take time and the exercise of patience, and can only be done by having the best cars imported. The more so is this necessary when the fact is taken into consideration that English manufacturers have given the subject much careful attention of late years and made such strides in their attempts to perfect the motor.

GRAMM A WINNER IN CALIFORNIA.

In a 100-mile commercial car contest between San Francisco, San Jose and Oakland, Cal., a Gramm truck, carrying an overload of 1053 pounds and three men, won out on all points, earning an absolutely perfect score, technically and mechanically, besides beating all other contestants on the score of economy. The fuel and oil expense was only 1.23 cents per ton mile. The contest was watched with keen interest by United States and Japanese army officers.

INCREASED ITS FORCE THREE HUNDRED.

The Hercules Buggy Company, of Evansville, Ind., announced that after the first of the year it would increase its force of workmen three hundred. This will make nine hundred workmen in the factory.

FROM TREE TO TIRE.

A goodly number of the automobile owners of the country know something about the moving picture entertainment given by the B. F. Goodrich Company. The middle of last April this company engaged the service of a lecturer and an operator to present a series of moving picture views, illustrating the entire process "From Tree to Tire."

These motion pictures were taken at large expense to the company. They represent the South American phases of the process, the tapping of the rubber tree, the preparation of the rubber milk for shipment, the inspection of the large markets, and the loading for foreign ports. The Akron views illustrate every one of the steps taken at the factory to produce an automobile tire—from the washing of the crude rubber to the shipment of a White Tread.

At the very outset the idea candidly showing the tire user how a tire is made, and how he should use it for his economical advantage, met with the heartiest demonstrations of approval. The warm weather did not diminish the attendance. Requests for "dates" have been more numerous than could be met. The territory covered thus far, has included Ohio, Pennsylvania, New York, New Jersey, West Virginia, Maryland, Connecticut, Michigan, Wisconsin, Minnesota, Illinois, Indiana, Missouri, Kansas, Nebraska and Oklahoma.

Over 40,000 people have attended the presentation of the story "From Tree to Tire." In Detroit, for example, on the first night the attendance was over 2,500, one-fifth of the audience standing. Over 2,000 people were turned away. The demand for a return of the show was so great that in a few days it was given again in the Light Guard armory. The attendance was over 4,400.

In the Kansas City Convention Hall the entertainment was given before 6,000 people. The audience was a very representative one, consisting of leading business and professional men and their families. All the automobile dealers attended. The three automobile driving schools and the local Automobile Drivers' Club came in a body.

NEW KIND OF PNEUMATIC CUSHION.

An invention known as Cox's pneumatic cushion is said to have solved tire trouble. The principle employed is not classed with the pneumatic spring, either of the flexible or metallic type, wherein the load, or shock is sustained by an increase in the air pressure or the rebound retarded by any mechanical device. This principle is absolutely new, and can only be likened to the pneumatic tire principle itself.

The three principal factors of the pneumatic cushion are a flexible, pneumatic spherically formed cushion with a solid and a hollow shank, which are a part thereof. The hollow shank admits the conduit and also provides a means to anchor the cushion to the vehicle frame, and the solid shank pivots the cushion to the deforming means, which is bolted to the axle. The cushion is fabricated and constructed along the lines of the pneumatic tire. An auxiliary air reservoir is connected to the cushions by conduits and provided with a check valve inlet through which the system is inflated. A convex formed device (with a receptacle for the solid shank to fit in) deforms the cushions by folding the walls inwardly, thus increasing the area of the cushions according to the violence of the shocks received from the irregularities of the road, but not increasing the air pressure.

By the use of a flexible cushion, in combination with an auxiliary air reservoir, at a low air pressure, and a convex device to deform the cushions, the following results are obtained:

The cushion, like the pneumatic tire, will deform under action, thereby producing a greater contact area with whatever supports it. The auxiliary air reservoir attached to the cushions supplies the necessary volume of air, at a low pressure, to diffuse vibrations; it also, owing to the difference in the amount of air displaced from the cushions, relative to the entire volume of

air in the sure, irrespective follows that the shock is sustained, or load added; then it a sustaining influence the system.

This principle obviates metallic or pneumatic springs, the pressure per inch in bound is measured by the pre- strain on the cushion wall the velocity of the rebound. The convex device to deform the cushions, that the slow increase in the area to sustain the shock is produced relative to pneumatic in-

travel is obtained. The available pneumatic travel with an eight-inch about five inches. The thickness of the walls is three- inch. The pressure per inch is about eighteen pounds of front and sixteen pounds for the rear, six cushions being four in the rear and two in the front for a touring car. The mechanism is being used for motorcycle seats, and may be used under the seats of any vehicle, including street cars and railway coaches, also for many other purposes.

COMPARISON OF AMERICAN AND GERMAN MOTOR VEHICLES.

In comparing American with German motor vehicles, especially those for delivery service and other commercial purposes, the up-to-date type of the former is generally superior to the latter in the following respects: (1) Less weight per unit of efficiency; (2) more complete interchangeability of parts, including removable power plant, so that machine is easier to repair and keep in order; (3) vehicle so constructed that the passenger body may be easily and quickly substituted for the delivery or freight body, thus enabling one machine to answer the purpose of two; (4) greater accessibility of machinery and mechanical parts; (5) the simple mechanical construction of the typical American machine renders it easier for one who is not a mechanic to operate and keep the same in order, while the consequent reduction of labor and danger from accidents tends to increase sales among those who cannot afford a chauffeur; (6) greater ingenuity of construction and convenience of operation, and, in general, a more practical application of advanced mechanical ideas to meet the various requirements of merchants and other local carriers.

THE THOMAS TROUBLE.

The E. R. Thomas Motor Car concern in Buffalo, one of those in the spot light for some years, has had a creditors' committee mousing about its assets, and getting matters in shape, it is said. The cause, according to Motor World, "is said to be due to its failure to charge off anything for depreciation of plant or equipment for a long term of years, and to the carrying on its books of several large and hopeless losses, its assets and resources thus appearing much greater than really was the case.

Next!

NEW MOTOR COMPANY.

A new motor company which will manufacture commercial motors for automobile trucks, delivery wagons and like vehicles, is being formed in Aurora, Ill. It will take over an old plant of the Sommer Motor Company. Among those behind the enterprise are Frank R. Reid and his brother, William Reid, and Albert C. Wilson.

IMPROVEMENT IN AUTOMOBILES

The carriage builders' art is being judged, from the accounts of such exhibitions of Cooper's Journal at the

Coachwork showed great improvement being greatly in advance of either here or on the Continent. The prevailing note of the lines and eloquent curves. The subdued color schemes prominent on nearly every stand, through the medium of the torpedo or flush-touring car were shown, the great improvement being as far as the show is concerned, the absolutely simple and restrained in themselves, tend to relieve the monotony of the plain flush side. Several of these cars were designed on the lines of two cab-shaped bodies successfully adapted one to the other, while others had a cab-shaped seat in front with high doors, with a suitable tonneau back portion, generally rounded shaped, though often finished with fish-tail corners behind.

One of the most decided features of the show was the number of high-grade two-seater bodies, nearly all of which were of the torpedo or boat-shaped pattern. A good proportion were fitted with landaulette or cabriolet heads, and in many cases it was evident that no pains had been spared to procure most luxurious and beautiful carriages. Quite a new type of this body was fitted with a removable limousine top, with a D front, the D glasses of which opened with the doors. The most noticeable development in limousine building was the inclusion in the show of a number of entirely closed vehicles of this type, in which the driver's seat was in the same compartment as those of the other occupants. Entrance was gained for the most part by doors amidships, the entrance to the driving seat being obtained by shifting the near side front seat in one way or another. In one of two examples however, the doors were placed in front, entrance to the rear seat being gained by lifting up or otherwise manipulating the near side front seat, arranged in the same manner as those previously mentioned. Some further enclosed limousines were provided with four doors, two forward and two in the middle of the body, so that any of the seats could be reached without disturbing the other occupants—to our mind the best of the three varieties. The extra expense to the coachbuilder in providing these doors is not very considerable, and not only is much more convenience obviously afforded to all the occupants, but in case of an accident all the passengers in the car can alight without delay.

Coincident with this development in the limousine has been the introduction of back pillars swept to produce what is generally known as the sedan chair effect. A number of limousines on these lines appeared in the show, and were characterized by an air of lightness and grace enhanced by the adoption of domed roofs, and not obtainable with the old straight or slightly swept lines. The light effect was accentuated by frameless windows, the use of which appears to become more and more general.

The closed carriages in the show were more or less provided with ventilators, a now necessary feature, in view of the efficiency of the enclosing panels employed, whereby passengers, both in the front seat and inside the car, are shielded from the cold winter winds. Nevertheless, it follows that in milder weather better means of ventilation are required than in the earlier types of cars, and the necessity is met by means of grid or flap ventilators in the dome of the dash, by torpedo ventilators in the front or

sides of the car, connected by shutters with the interior, or by ventilators of the sliding grid type under the cant, front or back rail. Some cars are also provided with a glass flap ventilator in the roof which, open or closed, serves as a skylight, and others have shallow lights over the door and quarter glasses, which, opening inwards when required, also serve to ventilate the interior.

Thus far has the art of coachbuilding progressed since the days when a winter drive in a motor car was a practical impossibility to a delicate person.

Two limousines in the show were fitted with sliding roofs which, to a certain extent, had the advantage over an open car and certainly admitted plenty of air without causing a draught. This type of vehicle would be particularly useful to ladies in delicate toilets, which might suffer from the dust, as the limousine back, and the immovable 12 inches or so of roof at the rear effectively prevent a back draught with its attendant dust. The domed dashes themselves are greatly responsible for the necessity of this ventilation for the front seats. They are mostly spacious affairs, covering in very effectually the front parts of the car, while some are extended along the doors and brought right up to the steering wheel, so that in conjunction with the wind screen, they render a draught almost impossible. Moreover, these dashes have afforded the coachbuilder the opportunity for the exercise of his cabinet-making art, being replete with lockers, cupboards and drawers, to accommodate the thousand and one articles needed on a long journey. For the most part these are placed at the top of the dash just under the dome, or in the corners, and extend from top to bottom on the near side and over the steering pillar on the off side, the space below being left clear for the pedals, etc. In this type of dash the necessity has also been admitted of a small light in the centre of the dome, illuminating the speedometer and other dials. In some instances, however, the top panel of the dash is replaced by the lower half of the wind screen, a particularly good arrangement, and one, moreover, which is likely to take on in the future. In one notable example of this practice a meshed glass is used—a material most suitable for the purpose. Its only advantage is that its dazzling affects the eyes, and this is immaterial when the glass is fixed in the manner described above. The cult of the domed dash is so popular that they are fitted even on coupe bodies, the wind screen or front light being brought nearer to the seat to a degree corresponding with the depth of the dash. Whether in the case of these and similar bodies this is altogether desirable is open to question, as the inside space is lessened as regards the upper part. In the case of coupe cabriolets and landaulettes, however, it can be understood that this is an advantage, as the length of the cant rail is greatly lessened.

Before leaving the subject of domed dashes we may mention a touring car upon which such a dash was fitted behind the driving seat, protecting the occupants of the rear seat. When entering the back part of the car it was necessary on opening the door to lift up the covering panel, trouble which could have been avoided by the use of an automatic lifting apparatus shown on a two-seated car last year, in which the opening of the door automatically raised the dome.

Cabriolets were greatly in excess of those in last year's exhibition. The underlying principle of their construction has not changed, but there were several ingenious arrangements for easily folding the hood, and, moreover, for holding it with very little overhang. In addition, several convertible bodies based on the cabriolet were to be seen in the show.

A noticeable feature in all these covered cars was the prevalence of cabinet work, some ambitious and entirely successful attempts in this direction finding their expression in elaborate inlaid receptacles for the inconvenient yet indispensable trifle. fitted, in the case of large limousines, under the front light. Garnish rails were often of polished wood, in some cases the whole of the inside door panels being finished in that material, as were the upper quarters and roofs. Very beautiful were the woods employed for inlaid work in this direction. One of the Continental

builders used violet stained wood inlaid with amaranthe in one limousine. In other cases, walnut or mahogany, stained or fumed, to harmonize with the upholstery, and afterwards polished were used with very good effect. Nor was the cabinet maker's work absent from the touring car, in which well-designed lockers and receptacles for small luggage were neatly and conveniently introduced.

Inside roofs and extension canopies were embellished with mouldings, generally of the same wood as the roof. A very favorite style consisted in mouldings converging to the center and finished by a star or medallion enclosing the sunk roof light.

A 30-horsepower car presented some particularly graceful lines, notably a fish tail corner extending down the boot panel to the bottom side. The panels were painted green with vertical stripes of a lighter shade, picked out in the centre with a fine white line. The window frames were rounded off $\frac{3}{4}$ -inch to the glass, and the bottom frames of the front windows were swept to follow the curve of the front seat back—details small in themselves, but which add immeasurably to the beauty of a carriage.

The great feature of one stand was a special convertible body, well finished in brown with $2\frac{1}{4}$ inch black stripes, picked out in the same shade, a brown belt rail making an unbroken line from the front to the rear of the car. It was fitted with a cape hood, and the front window was made to drop behind the driving seat. To exclude any possibility of draught a flap or curtain was provided, extending from the inside of the hood to the top of the window, where it was fastened by turn buttons. When the front window was dropped, the front standing pillars folded inwards. A detachable cantrail was fitted over the door, on removing which the hind standing pillar falls back with the hood. Side curtains, also fastened by turn buttons, afforded complete protection to the occupants of the front seat. A mahogany half-pillar was attached to the front glass slide filling in the space between it and the pillar. This fitted into a groove in the detachable cantrail over the door, thus giving extra rigidity. When the glass slides were folded, this pillar covered the whole of the fence rail. A large mica window was provided at the rear of the Cape hood, having a rolled up curtain which could be let down at will. Morocco hide upholstery exactly matching the panels gave a smart finish to a novel and serviceable all-weather car.

WOOD IN THE AUTOMOBILE FACTORY.

Metal is naturally being used for the production of all parts of the automobile which can be made from it to advantage, nevertheless wood holds an important place in the industry.

All motor cars contain some wood in the bodies and in many cases the entire tonneau or limousine as the case may be, is constructed of wood. For this purpose poplar is principally used and in many cases it is required in exceedingly wide plank so as to bend into the proper form.

For the curved backs of the limousine 3-ply stock is generally built up from thin poplar. Sometimes ash is used in constructing certain portions of the body. Mahogany is frequently used in the dash or in other exposed parts which are finished in the natural wood. The running boards are frequently made of ash. Hickory is employed for the wheel spokes. When the automobile top is supported on wooden bows, rock elm is used. Even in the case of the so-called metal bows for supporting the top, the sheet metal generally contains a filling of wood and this filling is made up of elm or ash.

The steering wheels are always made of some high grade wood such as mahogany or rosewood. Naturally in the pattern department of the automobile factory considerable quantities of white pine and mahogany are used for the construction of patterns.

Despite the fact that so much metal enters into a modern car, there are few similar manufacturing lines which make heavier demands on the wood merchant. Everything that is supplied to the automobile factory must be of the highest class.

SELDEN PATENTS NOT INFRINGED.

Manufacturers of Cars Will Escape Royalties Under Decision of United States Court of Appeals.

In the United States Circuit Court of Appeals on January 9 Judge Noyes handed down an opinion in which he held that the engines used in automobiles do not infringe on the patent for engines granted to Geo. B. Selden, a lawyer, of Rochester, on November 5, 1895.

Selden claimed that his patent was a basic patent and covered all engines in autos, and sued to recover royalties. He won in the United States Circuit before Judge Hough, and the decision handed down in the Court of Appeals is a reversal of Judge Hough's opinion.

The effect of this decision is that seventy-three domestic and seventeen foreign manufacturers of automobiles, licensed under the Selden patent, will no longer have to pay royalties, which have amounted to more than a million dollars.

The particular case which brought forth the decision was that of the Electric Vehicle Company and Selden against the Ford Motor Company and C. A. Duerr & Co.

It was announced that the Columbia Motor Car Company and George B. Selden are arranging to apply for a writ of certiorari with a view of having the case go to the United States Supreme Court for final decision.

NEW VALVE GEAR.

In the Paris salon there were a number of new features especially those showing something different in valve gearing.

We show three illustrations of the Henroid rotary valve gear, the feature being a D-shaped valve for each cylinder. The valves are mounted on a single shaft carried horizontally and driven by a vertical shaft and spiral gearing from crankshaft.

The first illustration (left) shows commencement of intake

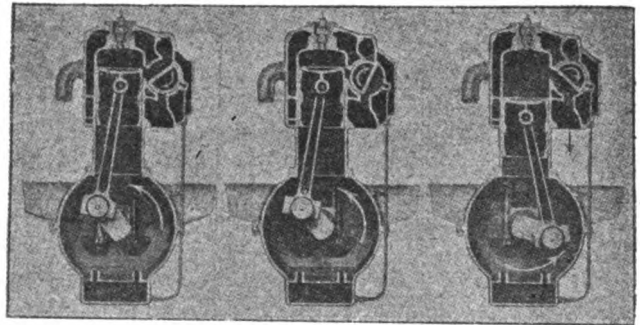

stroke, the flat face of valve giving communication from the induction pipe to the port. The next illustration shows the commencement of the firing stroke, the D-valve having closed down all but a small part of the valve chamber, so there is little loss of pressure. The right illustration shows exhaust stroke, flat portion of valve making connection from cylinder port to exhaust outlet.

NEWARK AUTOMOBILE SHOW, FEB. 18-25.

As has been the custom since the first automobile show, the fourth annual one will take place in Newark, N.J., during week of the anniversary of Washington's birthday, February 18 to 25 inclusive, 1911. This is one of the really interesting shows, as the crowd is not too great to prevent a careful inspection and even an examination of the vehicles, which have always been widely representative of the high, medium and cheaper groups.

At the public sale of the assets of the bankrupt Detroit-Dearborn Motor Co., in Detroit on December 16, the property brought \$14,800. It was bid in by Vernon C. Fry, who will head a new company that will operate the plant and at once begin to turn out cars.

GENERAL MOTORS MAKES SHOWING.

For the first time since Wall street interests advanced the loan of \$15,000,000 to the General Motors Company and took a mortgage on its assets and assumed practical direction of its affairs, a statement of the \$60,000,000 company's condition has been issued. On their face the figures show that its net profits for the year ending September 30, 1910. were \$10,266,322.27, and that its total assets are \$37,770,363. The statement is in the form of a printed circular issued "for the benefit of investors," and is in no wise a detailed one, but the bankers point out that the year's profits are sufficient to meet more than eleven times the interest on the \$15,000,000 note issue and two-thirds of the principal. The statement really comprises a report of financial conditions rendered by W. C. Durant, vice-president of General Motors, based on an audit made by Marwick, Mitchell & Co., chartered accountants, as of September 30.

In both sets of figures the proceeds of the note issue are included in the assets, and thus swell them to the extent of \$15,000,000, but the note issue for this sum does not appear in the liabilities. When Mr. Mitchell, of the accounting firm, was asked to explain this apparently great inconsistency, he explained that the published statements were not to be construed as a trial balance sheet, but merely as a guide to show investors the extent of the security behind the big note issue. "In placing the liabilities at \$14,225,105.23," he said in substance, "the accountants did not include the \$15,000,000 of notes issued or to be issued, in order more plainly to show the equity which would guarantee the notes—the security which would guard prospective investors. While the notes themselves are not included in the liabilities of the companies, the proceeds to be obtained from their sale were included in the assets, and although these facts are fully stated in parentheses in the text of the table, their exclusion from the liabilities tends to create a favorable first impression upon the prospective investor, which naturally is the object of a prospectus sent out by banking houses interested in sale of such shares."

The published circular makes known that the bankers have formed a finance committee to control the finances of the company. It is composed of Emory W. Clark, A. H. Green, Jr., M. J. Murphy and Thomas Neal, the four Detroit men, who last month were added to the board of directors; W. C. Durant, of Flint; James J. Storrow, representing Lee, Higginson & Co., and Albert Strauss, representing the Seligmans.

S. A. E. ANNUAL GATHERING.

The Society of Automobile Engineers will hold its annual meeting January 11-12, 1911, in the quarters of the Automobile Club of America in New York City.

The opening session will include an address by President H. E. Coffin, followed by election of members and reports of the treasurer and council. Reports on the election of officers and a discussion of proposed amendments to the constitution of the society will probably conclude the session.

The first professional session is scheduled for the afternoon. According to reports, it will include papers on "Electro Steel," by Joseph Schaeffers; "Physical Facts Relating to Metallurgy," by Radclyffe Furness; reports of the Committee on Standards, including those divisions on the various metals, parts and generally on standardization. A. L. McMurty will deliver an address on "Contest Rules that Affect the Engineer." The matter of contests will be treated in two or more additional papers, one of which will be by Chester S. Ricker, who will discuss timing and coaching.

Wednesday evening will be devoted to a reception at which the retiring president and the president elect will speak. This will be followed by the annual dinner and entertainment.

A professional session will convene at 9 o'clock Thursday, at which a number of important subjects will be covered. Logan Waller Page, of the Department of Agriculture, will treat of the

construction of highways for motor traffic; "Leaf Springs," E. K. Rowland; "Valve Systems," E. P. Batzell; "Hot Roller Gears," H. N. Anderson, and "Commercial Gasoline," F. H. Floyd.

Thursday afternoon's professional session will be occupied by half a dozen addresses, including the following: "Bearing Metal Tests," S. P. Wetherell, Jr.; "Test of Franklin '20' Air-Cooled Car," L. R. Evans; "Development of Grinding Wheel," G. N. Jeppson; "Methods of Grinding," John C. Spence; "Frictionless Friction Drive," C. E. Duryea; "Fire Protection," N. B. Pope; "Multi-point Ignition," Otto Hains.

"Commercial Vehicles" will be the subject of the evening session. "Standardization" will be treated by W. P. Kennedy; "Vertical Motors under Foot Boards," by B. D. Gay; "Proper Speed," by P. H. Breed; "Chain Drive for Trucks," by the same speaker; "Gasoline-Electric Transmission," Alex. Churchward; "Fool-proofing the Commercial Car," A. J. Sjade; "Co-operation Between the Electric Vehicle Maker and Central Station," Robert McA. Lloyd; "Multiple Uses of Municipal Service Machines," John M. Mack; "City Merchandise Transportation," Hayden Eames; "Production of Commercial Vehicles," Charles E. Hadley; "The Ampere-hour Meter," C. A. Lamphier, and several other interesting papers will be presented by eminent engineers.

STANDARDIZED CHASSIS SECTIONS.

The American Society of Automobile Engineers has begun the drawing up of standard specifications for parts and sections of chassis that permit of uniformity without crippling inventive resource, commercially based. Frames have been selected to commence with. The subject has been divided into two sections. The first concerns (a) the quality of the steel to be used, and (b) the physical properties and heat treatment best suited for uniform quality. The second concerns the design of frames generally. Nothing has been published relating to the first section, but the following schedule summarizes the principal points to be regarded as concerning the second section of the investigation.

Side Frames—(1) Main section, including stiffeners; thickness of metal; thickness relative to depth of section and width of flange.

(2) Standard front ends. Here appears to be a point in which great good can be accomplished. It is said that there are a thousand current designs of frame front ends. These the committee will reduce to possibly a score of front end curves. Naturally this involves a good deal of work by the sub-committee.

(3) Standard taper for rear end.

(4) Uniform radii of curves and depth of drop for drop frames and double drop frames.

(5) Main width of frame at rear end.

(6) Offset of side rail to produce front end width. Proportion: of length of offset to amount of offset.

Cross members—(7) These are straight and curved. As to the former, matters to be considered are standard radius and length for integral gussets, which should preferably, as a matter of cost of production, be on the cross bars instead of on the side rails; as to the latter—curved cross bars—standard radii and amount of drop of front member, and in general harmony of design with relation to strength and weight of side bars.

Sub-Frames—(8) Dividing into amount of drop, width between engine bars, and taper of engine bars.

UNITED STATES MOTOR RE-ELECTS DIRECTORS.

At the annual meeting of the United States Motor Co., which occurred on Tuesday, December 20, in Jersey City, the board of directors, fifteen in all, were re-elected. They are: Benjamin S. Briscoe, J. C. Brady, J. D. Maxwell, C. G. Stoddard, K. B. Schley, Frank Briscoe, Horace de Lisser, J. H. Edwards, R. Irvin, E. Lloyd, O. J. Mulford, W. H. Nuckols, R. A. Robinson, J. W. Wellington and C. Tucker. These directors will meet later and re-elect the officers.

RESILIENT HUB OF UNDOUBTED MERIT.

The interposition of an air cushion between the body of a wheel and the axle on which it rides is by no means a new idea, but early efforts to obtain a resilient wheel by such means were attended by failure. The chief object of their inventors is the production of a wheel that possesses most of the advantages of the ordinary form of pneumatic tire while eliminating its recognized weaknesses.

The accompanying illustration will serve to show the details of construction of a new hub named "Simplex." The air cushion is free to alter its shape according to the variations of the load imposed upon it, and the movement is localized to a definite portion of the air cushion—the part which corresponds to the tread of an ordinary tire. This localization affords a maximum of resilience with the least-possible amount of movement between the various layers of fabric and rubber of which the walls of the cushion are made; chafing of the material and the generation of heat due to friction are minimized, and life of cushion enhanced.

There is nothing unusual about the main portion of the hub except that a deep flange projects from the inner end of the central sleeve, or hub, and between the hub and the flat surface of the flange there is a cup-shaped annular cavity (C). A similarly-shaped flange (A¹) is fitted over the central sleeve, and this flange is securely fixed by means of nuts on shouldered studs (C¹) so as to maintain a definite distance between the two

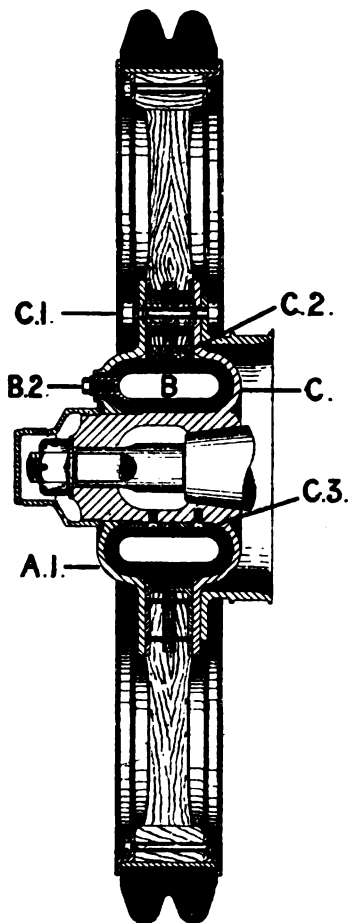

Hub as Applied to Live Axle.

flat surfaces of the side flanges; the body of the wheel is made a sliding fit between these two flanges, and it "floats" on the air cushion (B) which is housed in the annular cup-shaped cavities of the two flanges. The wooden spokes are wedge-shaped at their inner ends, and before they are assembled the ends are deeply mortised so that they may finally be fitted and glued into a circular ring. A pair of angle-steel flanges (C²), integral with which are a number of stout keys, or feathers, are then fitted to the wheel body; there are also a number of keys (C³)

fitted on to the central sleeve, and these two sets of keys engage with transverse slots in the outer and inner circumferences respectively of the air cushion (B). The air cushion, therefore, not only sustains all imposed loads on the wheel, but it absorbs many of the shocks due to inequalities of the road surface, and, further, to a certain extent, it acts as a spring drive. The cushion is built up in the same manner as a single tube pneumatic tire, and it may be inflated to any desired pressure, the air being forced through the valve (B²) by means of an ordinary tire pump.

When heavily loaded, an ordinary pneumatic tire obtains a

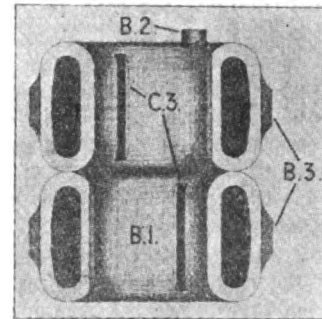

Air Cushion Cut in Two.

large bearing surface on the road, only by reason of the flexibility of its side-walls; in other words, its sides bulge out and thus permit more of the relatively stiff tread to be flattened down on the road surface. The increased area is available to support the imposed weight, although the air pressure inside the tire remains virtually the same. With a pneumatic hub, however, there is no reason why the air cushion should be allowed to bulge out sideways, and it is with the object of preventing it that, in the Simplex hub, the flanges C and A¹ are made to fit up tightly against the side walls of the air cushion. There is nothing to prevent the cushion's "tread" being made thinner than is necessary with a pneumatic tire, while many advantages are to be derived from making the cushion wider and of less depth. Such a shape as the cross-sectional view shows, permits of a considerable amount of motion in the desired direction without imposing undue stress in the walls of the cushion, and thus the supporting area of contact between the cushion and the wheel centre may vary over a wide range without seriously heating the fabric. It should be noticed that the "tread" (B³) is considerably narrower than the air space of the cushion. The air cushion plays precisely the same role as a pneumatic tire, since the displaced air "rolls" round inside, and the degree to which that displacement takes place depends upon the weight carried by the axle.

G. J. G. COMPANY TO BUILD RUNABOUT.

The G. J. G. Motor Car Company, of White Plains, N. Y., has made announcement that it will turn out a new type of runabout beginning February 15. The motor has four cylinders, 3 5/8 x 4 1/4 inches cast of gray iron. The crank and cam shafts are drop forged, supported on Parsons' white metal bearings. The ignition system is by magneto, and the circulation is provided for with a centrifugal pump and Mercedes radiator. Cone clutch, splash lubrication, semi-floating rear axle and other standard features are included in its specifications.

TO KEEP PUTTY SOFT.

Many persons have putty left over and wish to keep it from drying out and hardening. It can be kept by putting it in a tin can and covering it with water. It can be kept for any length of time by keeping it in water and will be just the same as when put in, water having no effect upon it. This has been tried and is successful.

WEIGHT DISTRIBUTION.

Of the many problems met in automobile design that of weight distribution is not the least important, nor is it one that has received the attention of the average designer in the measure it deserves.

Like all the tasks imposed by modern automobile construction, weight distribution must be largely a matter of compromise, says J. D. Maxwell. In this respect the problem resembles that involved in spring design. Here, too, it becomes evident that it is difficult to provide a spring that will give equal resiliency in an empty car and in one that carries its full quota of passengers. Similarly, weight distribution becomes a somewhat complex proposition when it is considered that it is impossible to distribute the dead weight of an automobile in such a manner that the mechanical equilibrium will not be interfered with when the car is running with a load or without it.

These questions, however, while interesting to the engineer, are of less importance to the automobile user, except in the relation they bear on his tire consumption. For here again it is impossible to strike a fair mean. In other words, it is out of the question to secure for one tire as little wear as is encountered by the other, although the four tires may be of uniform structure and quality. Even in a case where the greater weight of the car is in the front the greater wear is sustained by the rear tire. In this connection it must be remembered that the propulsion of a motor vehicle differs materially from that of a horse-drawn vehicle in that the latter is pulled over the road surface, while the former pushes itself along by the tractive effort.

As far as the weight of the car itself is concerned, regardless of its distribution, it is a common experience that the lighter car produces the smallest tire bills, for it has been proved that the life of a tire is inversely proportional to the cube of the load it supports, so that if the load is doubled the average wear and tear on the tire will be multiplied by eight.

But there are other points that are worthy of attention, some of them having to do with the design of the car and with the manner in which motor vehicle elements are supported. That in a car in which there is more weight on the left side than on the right side the right tire will wear excessively, is clear, nor is there any doubt that cars are built in which the weight is thus unevenly distributed.

The trouble lies with the designer who instead of taking into account the general usefulness of the car together with the tire problem, considers his task finished when he has produced an acceptable chassis, and who leaves the rest to the tire manufacturer, who comes in for a share of objurgation that is not always deserved. True enough, when a tire is worn down at the heels all evidence seems to point to the guilt of the tire manufacturer, but, as said before, the accusing finger may often be pointed with even greater justice to the automobile designer who failed to make his product as harmonious as it should be in order to give ideal service.

In the matter of tire wear many motorists fail to bear in mind that as a mechanical device a vehicle wheel and the surface on which it runs cannot be considered apart. A vehicle wheel, in fact, is only one element of a mechanism, the other of which is the road, the one thing as necessary as the other. Since the automobile is essentially a road vehicle much of the tire trouble encountered must be laid to the condition of the road rather than to the vehicle wheel or to the tire with which it is shod.

TO MANUFACTURE AUTOS.

Hahn Brothers, carriage manufacturers, Hamburg, Pa., have procured a license for the manufacture of automobiles, which will hereafter be one of the most important branches of their plant, which has recently been enlarged.

The two vehicle factories of the Moline (Ill.) Plow Company are again running in full swing. The schedule has been changed back from eight to ten hours and the force has been enlarged.

WATER-COOLED ASSURANCE

One of the contentions put forward by express companies is that they are required to pay a large portion of their gross income to the railroads for the transportation service rendered and are thus compelled to keep their rates where they are and in some cases should be permitted to raise them. The commission's answer is: "Without, at this time, entering into the question of the propriety of contracts such as are made by express companies with the railroads or their effect upon transportation, it is sufficient to say that an express company or common carrier should not be permitted as against the public to insist that a contract, of its own, that it had voluntarily entered into was a reason for increasing the burden of the shipper. These contracts are voluntary undertakings between these respective parties to which the public is not a party and afford no excuse for rates which would, but for such contracts, be lower. Express companies, because of their peculiar relation and complicated connections with railroad companies, may submit to and execute contracts which they say are unreasonable. The public should not carry the burden for them by paying advanced rates for which there is no shadow of reason."

"GRAND ECART."

The Marquis DeDion, head of the De Dion-Bouton auto works at Puteaux, France, has made a suggestion that it is supposed will be acted upon by the Automobile Club of France, an organization equally interested in aviation subjects.

The Marquis thinks the awards for just speed in flying machines do not cover the subject. There should be tests to determine how slowly a plane could move through the air, also. To bring this about he suggests the Grand Ecart. The money value of the prize is to come from the contributions of sportsmen, and will depend on the liberality of such people.

The Marquis explains his notion this way: "The problem that should engage the contestants would be the covering of a stated course as rapidly as possible, then to go over the same course just as slowly as possible. The chronometer charts to be relied upon in both instances for the determining results. This will solve a difficult problem."

The matter has been taken up well and we shall no doubt see contests of the kind. It would be a very interesting test for a heavier than air machine to just move through the air, something like a bird poising in flight.

Wants

Help and situation wanted advertisements, one cent a word; all other advertisements in this department, 5 cents a word. Initials and figures count as words. Minimum price, 30 cents for each advertisement.

POSITION WANTED.

Wanted—Carriage and Wagon Painter. A No. 1 letter striper and finisher, capable of foremanship, desires position. Fine business wagon and truck work preferred. Address W. D. L. care The Hub, 24 Murray St., New York.

FOR SALE.

For Sale—Carriage and blacksmith business in town of 15,000 population. New two story, up-to-date, concrete block shop, 30x50, all the latest machinery, electric power, trip hammer, planer, band saw, lathes, drill, press, etc. Two lots, 25x125, and four room house. Good business, am selling on account of accident which renders me unfit for work. Address R. J., care The Hub, 24 Murray Street, New York City.

BUSINESS OPPORTUNITY.

Business Opportunity—A sound Danish automobile factory seeks connection with a first class automobile factory capable of quick delivery. Any firms interested are requested to send their catalogues to Ingvar Tander, Aahuss, Aarhus, Denmark.

PATENTS.

Patents—H. W. T. Jenner, patent attorney and mechanical expert, 608 F St., Washington, D. C. Established 1883. I make a free examination and report if a patent can be had and exactly what it will cost. Send for circular.

The TIMKEN ROLLER BEARING CO.

MAKERS OF TIMKEN ROLLER BEARING AXLES
for WAGONS and CARRIAGES



Canton, Ohio

A Set of
TIMKEN AXLES
will save your
CUSTOMERS
these two horses

This statement is based on the experience of thousands of users.

New Catalog and Price List upon application.

THE TIMKEN ROLLER BEARING CO.,
CANTON, OHIO,

BRANCHES- 10 E. 31 st Street, New York.
429 Wabash Avenue, Chicago.

HANDY LAMP GASOLINE LIGHTING SYSTEM

Draws Trade to Your Shop.

Gives a 300 Candle Power Shadowless Light the instant you move the lever. Turns up or down, like gas, burns dim when not in use, or can be turned up instantly when more light is needed. It floods a 30-foot space with a brilliancy like daylight. Far cheaper than gas, kerosene or electricity, and so simple that anyone can use it. You can depend on it for years for any purpose demanding a big, strong light. Catalogue H tells why: Send for it now.



BRILLIANT GAS LAMP CO.
DEPT. 29. 42 STATE ST. CHICAGO, ILL.

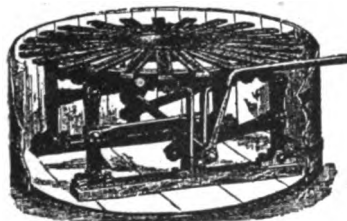

The Bokop Tire Setter and Cooler is the Best and Only Machine that has stood the test during the last 12 years on all classes of work, and is the Only Machine built with the Indestructible Wrought Iron Face Plate. Over 1,000 are in successful operation, repairs on which have not exceeded \$6.00 in the last 12 years. For prices, references and descriptive circulars, address **BOKOP, WEBB & PALM,** Defiance, Ohio

E. SCOTT PAYNE Co.
OF BALTIMORE CITY
CARRIAGE AND AUTOMOBILE
HARDWARE
362 and 364 North Gay Street,
BALTIMORE, MD.

CARRIAGE SPRINGS OF EVERY STYLE AND PAT-
TERN TO ORDER
Also Curtzin Rollers and Concealed Hinges
EXCLUSIVELY FIRST-CLASS WORK
THE BEST THAT CAN BE MADE
SPRING PERCH CO.
BRIDGEPORT, CONN.

Please mention "The Hub" when you write.

THE BALL MULTI-SPARK PLUG



"The Plug That's So Different"

The central electrode has a **SMALL BALL** on the end for the terminal, giving $\frac{3}{4}$ -inch sparking surface; it also acts as an electrical condenser, raising the voltage, increasing the heat and flame, thereby enabling the use of a poorer mixture to obtain the same power. It does not require cleaning often, the hot spark consuming the carbon deposit; will stand more oil than any other plug, and is carefully and substantially built.

THE BALL MULTI-SPARK PLUG CO.
917 Hennepin Ave. MINNEAPOLIS, MINN.

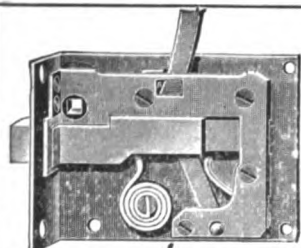

A. OCHSNER & SONS CO.
NEW HAVEN, CONN.

Auto and Carriage
Locks, Hinges, Etc.

VEHICLE AND AUTO TOP HARDWARE

Rails, Joints, Bow Sockets for the
WHOLESALE TRADE ONLY

Write

INDIANA FORGING COMPANY.

Mention Hub.

INDIANAPOLIS, IND.

Carriage Mechanics

Desiring to improve their present
Condition should attend the

TECHNICAL SCHOOL

FOR

Carriage Draftsmen and Mechanics

SUPPORTED BY THE

Carriage Builders' National Ass'n.

The object of the School is to teach men to design vehicles and make working drawings, and to otherwise facilitate their work in the shop. Only those men employed in carriage or automobile building or their accessory trades are admitted to its privileges.

The classes are conducted in three divisions, viz.: Corresponding, Day, and Evening. The former is open during the entire year, while the day and evening classes are in session only from October 1st to April 1st.

The tuition is moderate.

For prospectus and full particulars, write to the instructor,

ANDREW F. JOHNSON,

18 West Forty-fourth St.,

NEW YORK CITY.

INDEX TO ADVERTISEMENTS.

| | |
|------------------------------------------------|-----------|
| Aden Mfg. Co. | 17 |
| American Ball Bearing Co., The | 13 |
| American Roller Bearing Fifth Wheel Co. | 18 |
| Ault & Wiborg Co., The | 3 |
| Ball Multi-Spark Plug Co. | 12 |
| Bailey & Co., Inc., S. R. | 18 |
| Bokop, Webb & Palm | 11 |
| Brilliant Gas Lamp Co. | 11 |
| Boub Wheel Co., H., The | 18 |
| Cately & Ettling | 13 |
| Columbus Bolt Works | 4th cover |
| Consolidated Rubber Tire Co. | 2nd cover |
| Crane & MacMahon | 2nd cover |
| Devoe, F. W., & Reynolds Co., C. T. | 3rd cover |
| Eberly & Orris Mfg. Co. | 3rd cover |
| Eccles Co., Richard | 17 |
| Enterprise Foundry, The | 13 |
| Frantz Body Mfg. Co., The | 3 |
| Gifford & Son, John A. | 11 |
| Goodrich Co., B. F., The | 5 |
| Goshen Eyelet Co. | 14 |
| Gramm Motor Car Co., The | 3 |
| Hoopes Bro. & Darlington, Inc. | 2nd cover |
| Indiana Forging Co. | 12 |
| Jones & Co., Phineas | 6 |
| Keystone Paint & Filler Co. | 4 |
| Kilvington, S. W. | 18 |
| Kimble, Andrew | 4 |
| Masury & Son, John W. | 2 |
| McKinnon Dash Co. | 4th cover |
| Mercer, Geo. J. | 18 |
| Moller & Schuman Co. | 6 |
| Murphy Varnish Co. | 4 |
| Nelson Co., A. T. A. | 2 |
| New Wapakoneta Wheel Co., The | 4th cover |
| Ochsner & Sons Co., A. | 12 |
| Payne Co., E. Scott | 11 |
| Porter, H. K. | 17 |
| Reilly, John, Inc. | 2 |
| Russell, Burdsall & Ward Bolt and Nut Co. | 3rd cover |
| Schubert Bros. Gear Co. | 17 |
| Shortsville Wheel Co. | 13 |
| Smith & Co., Edw. | 6 |
| Spring Perch Co. | 11 |
| Standard Automobile Mfg. Co. | 1 |
| Standard Oil Cloth Co. | 18 |
| Standard Wheel Co. | 17 |
| Steel Socket Shaft End Co. | 13 |
| Timken Roller Bearing Co. | 11 |
| Uebelmesser Co., Charles R. | 14 |
| Valentine & Company | 6 |
| West Tire Setter Co. | 12 |
| Wilcox Mfg. Co., D. | 15 |
| Willey Co., C. A. | 4 |
| Woodman, Joel H. | 14 |

FRONT **AXLES** REAR
OF QUALITY

LET US HELP IN SOLVING THAT
MANUFACTURING PROBLEM

¶ BY FURNISHING YOUR AXLE EQUIPMENTS IN CARLOAD LOTS AS YOU NEED THEM AND WHEN YOU NEED THEM.

¶ I-BEAM OR TUBULAR FRONTS, CHAIN OR BEVEL DRIVE REARS, CUP AND CONE, ANNULAR OR ROLLER TYPE BEARING.

¶ OUR STANDARD EQUIPMENTS INCLUDE ALL THE IMPROVED TYPES IN USE.

¶ WE ARE SPECIALISTS IN THIS LINE AND OUR EXPERIENCE IS AT YOUR DISPOSAL.

THE AMERICAN BALL BEARING CO.

L. S. & M. S. RY. and EDGEWATER PARK
CLEVELAND, OHIO

Burlington Rubber Tire Machine

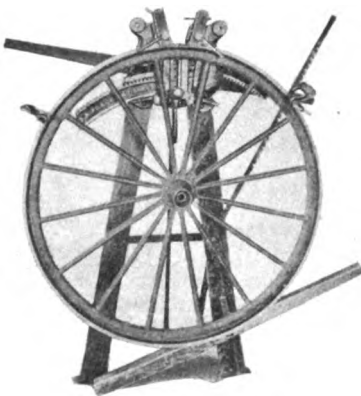

Our big No. 4 is the only machine made that will apply all kinds of solid and cushion rubber tires both internal and outside wires and close the joint on the same machine. One man can operate the machine easily without help. Put an end to your troubles in applying tires by investing in this machine. Write for descriptive circulars and price.

THE ENTERPRISE FOUNDRY
HARVEY, ILL., U. S. A.

Increase Your Sales?



By having your Buggies equipped with **CATELY'S BUGGY TOP SPRINGS AND LEVERS**. Pull on the inside levers and the top is lowered with ease. A gentle start and the top is up. Prevent broken bows and rattling joints. Best of talking points to interest trade and help sell your buggies. Manufacturers will put the springs and levers on your buggies when you so specify. Some manufacturers put springs and levers

on some styles of their buggies as part of regular equipment. Yours for the asking. We also have trade winners in standard Third Seats, Camp Stools and Auto Chairs. The prices are low so write for catalog.

CATELY & ETTLING, Cortland, N. Y.
Members Carriage Builders' National Association.

Splice Joint Shaft and Pole Ends
Give Perfect Satisfaction

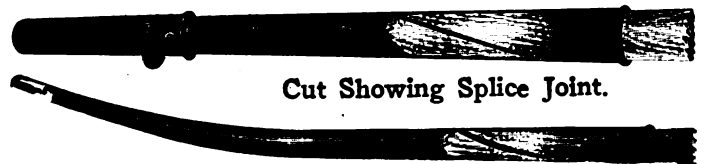

Cut Showing Splice Joint.

THE SPLICE JOINT where the woods meet adds great strength, guarantees them against breaking where repaired, and prevents working loose and rattling. No shaft end without this construction can possibly give reliable service. No other shaft end than the Splice Joint can have these advantages, as we are the original manufacturers, and these features are fully covered by our patents. Insist on having the original Double Tube Splice Joint Steel Socket Shaft Ends and you get the best.

Handled by All Leading Jobbers.

STEEL SOCKET SHAFT END CO. CLEVELAND, O.



Painters and Decorators Save Time, Labor and Money, using the

Uebelmesser Striping and Stencil Wheel

With this simple, clean and rapid-action tool the most ordinary decorator can do the finest striping and stencil work and produce a bigger day's work with less labor than by the old-fashioned method. Complete directions are furnished with each tool. They are as simple as the tool itself.

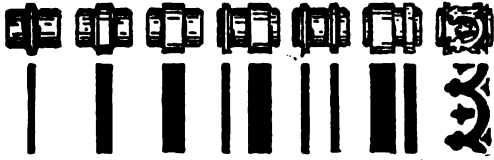

Just a few of the many designs that can be produced with the Uebelmesser Painters' and Decorators' Tool. (The designs shown above are reduced in size.)

Complete Outfit consisting of Machine, 10 Plain and 10 Ornamental Wheels, only .. **\$5.50**
LIBERAL DISCOUNT TO THE TRADE

Manufactured by

Charles R. Uebelmesser Company
Bayside, New York, N. Y.

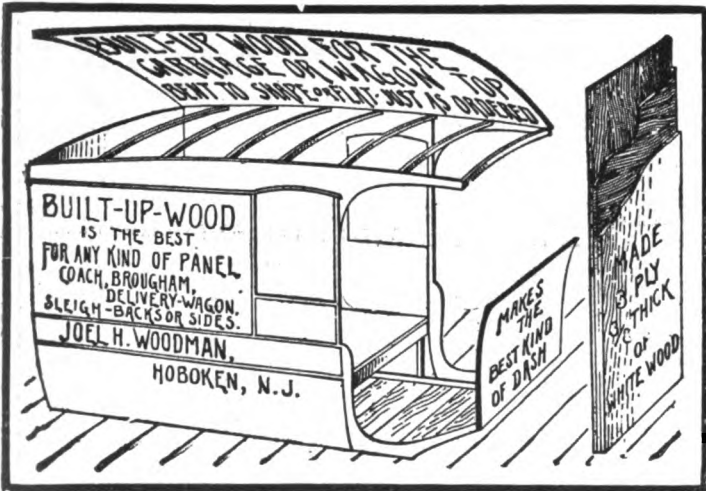

Goshen Eyelet Co.

Manufacturers of

Carriage Top Trimmings

GOSHEN, INDIANA

Advertisements Classified

The following list includes advertisers in THE HUB. Each advertiser is entitled to name under one heading only. An extra charge for name under more than one heading.

Axles

- American Ball Bearing Co., Cleveland, Ohio.
- Keagy & Lear Machine Co., Coshocton, Ohio.
- Timken Roller Bearing Co., Canton, Ohio.

Bodies, Seats, Etc.

- Frantz Body Mfg. Co., The Akron, Ohio.
- Kilvington, S. W., Wilmington, Del.
- Woodman, Joel H., Hoboken, New Jersey.

Bolts and Nuts

- Columbus Bolt Works, Columbus, Ohio.
- Russell, Burdsall & Ward Bolt and Nut Co., Port Chester, N. Y.

Carriage Forgings.

- Columbus Bolt Works, Columbus, Ohio.
- Eccles Co., Richard, Auburn, N. Y.
- Indiana Forging Co., Indianapolis, Ind.

Carriage Hardware.

- Gifford & Son, John A., New York.
- Ochsner & Sons Co., A., New Haven, Conn.
- Payne Co., E. Scott, Baltimore, Md.

Carriage Goods

- Gifford & Son, John A., New York.
- Higgin Mfg. Co., Newport, Ky.

Dashes, Fenders, Rails, Etc.

- Bennett Mfg. Co., Alden, N.Y.
- McKinnon Dash Co., Buffalo, N. Y.

Fifth Wheels

- American Roller Bearing Fifth Wheel Co., Brooklyn, N. Y.
- Wilcox Mfg. Co., D., Mechanicsburg, Pa.

Finished Vehicles

- Bailey & Co., Inc., S.R., Amesbury, Mass

Gear Irons

- Wilcox Mfg. Co., D., Mechanicsburg, Pa.

Gear Woods

- Andrew Kimble, Zanesville, O.

Lamps

- Gifford & Son, John A., New York.

Leather

- Nelson, A. T. A., Co., Cincinnati, Ohio.
- Reilly, John, Inc., Newark, N.J.

Lubricating Device

- Aden Mfg. Co., Dansville, Va.

Motor Trucks

- Gramm Motor Car Co., The Lima, Ohio.

Machinery and Tools

- Bokop, Webb & Palm, Defiance, Ohio.
- Enterprise Foundry, The, Harvey, Ill.
- Porter, H. K., Everett, Mass.
- Standard Automatic Mfg. Co., New York.
- West Tire Setter Co., Rochester, N. Y.

Miscellaneous

- Goshen Eyelet Co., Goshen, Ind.
- National Aluminum & Bronze Co., Indianapolis, Ind.
- Standard Oil Cloth Co., New York.
- Uebelmesser Co., Charles R. Bayside, New York.

Rubber Tires

- Consolidated Rubber Tire Co., New York City.
- Goodrich Co., B. F., Akron, O.

Shaft Couplings and Anti-Rattlers

- Eccles Co., Richard, Auburn, N. Y.

Metal Stamping Co., New York City.

- Steel Socket Shaft End Co., Cleveland, Ohio.

Spark Plugs.

- Ball Multi-Spark Plug Co., Minneapolis, Minn.

Springs and Gears.

- Keystone Spring Works, Inc., Philadelphia, Pa.
- Spring Perch Co., Bridgeport, Conn.

Varnishes, Paints and Japans

- The Ault & Wiborg Co., Cincinnati, Ohio.
- Devoe, F. W., and C. T. Reynolds Co., New York City.
- Masury & Son, John W., New York and Chicago.
- Moller & Schumann, Brooklyn, N. Y.

- Murphy Varnish Co., Newark, N. J.

- Smith & Co., Edw. New York.
- Valentine & Co., New York, Chicago, Boston, Paris.

- Willey Co., C. A., Hunter's Pt., New York City.

Wheels

- Crane & MacMahon, New York
- Eureka Bending & Wheel Co., The, York, Pa.
- Gifford & Son, John A., New York.

- Hoopes Bro. & Darlington, West Chester, Pa.

- Jones & Co., Phineas, Newark, N. J.

- New Wapakoneta Wheel Co., Wapakoneta, Ohio.

- Standard Wheel Co., Terre Haute, Ind.

- Wheel Stock, Bent Wood, Etc. Crane & MacMahon, New York

HEADQUARTERS FOR SPECIAL FINE GEAR IRONS [Dropped Forged] CARRIAGE HARDWARE

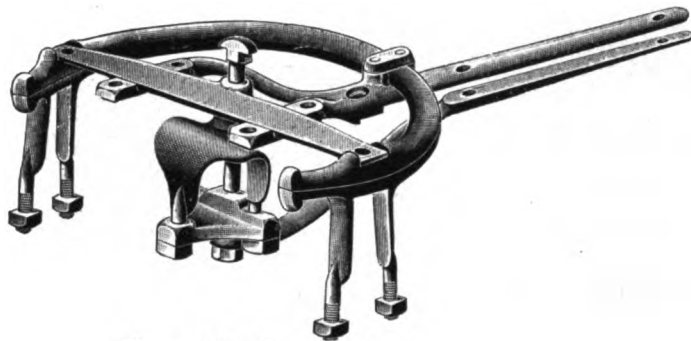

No. 1908—Gear Iron

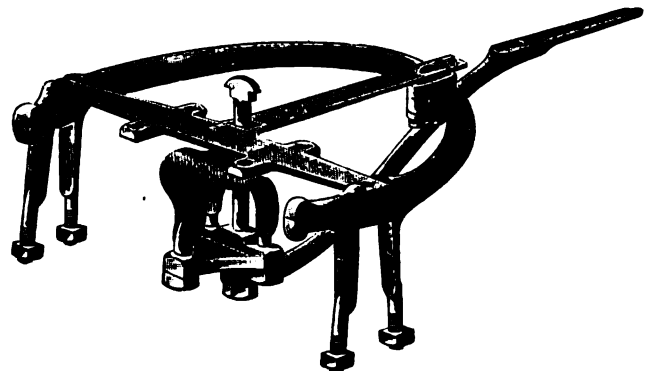

No. 2000—Gear Iron

WILCOX'S Mechanical 3 Prong King Bolt

Double Locked in Head Block
Plate and King Bolt Yoke. No
Strain on Bolt. No Turn on
Nut. Guaranteed.

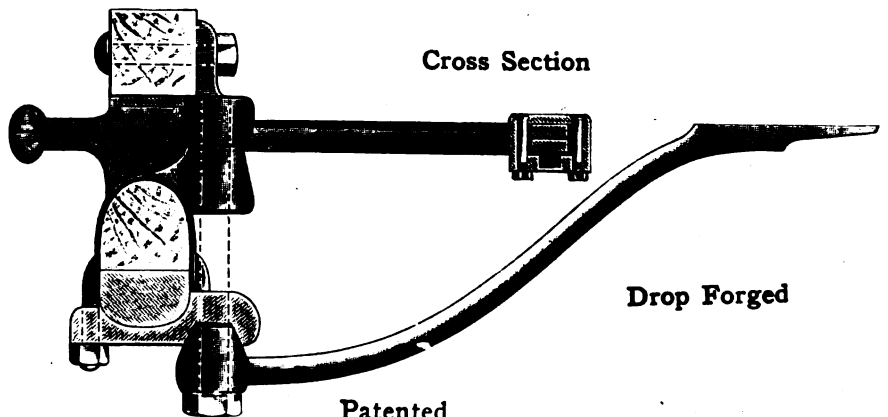

Cross Section

Drop Forged

Patented

S
U
R
E
S
A
F
E

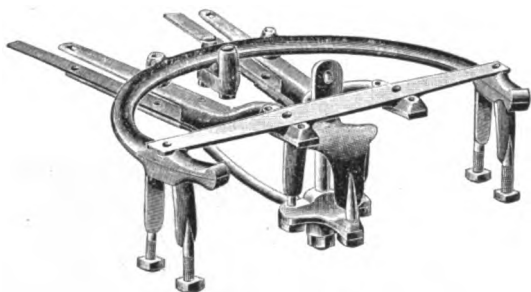

No. 1905—Gear Iron

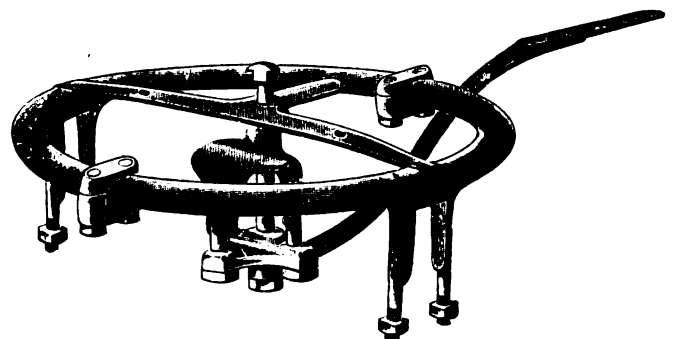

No. 1909—Concord.

Forget your trouble and decide at once to use WILCOX DROP FORGED IRONS. Write us for pleasure

The D. Wilcox Mfg. Co. Mechanicsburg Pa.

Please mention "The Hub" when you write.

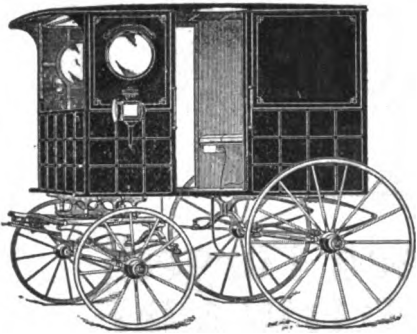

No. 112.—Milk Wagon.

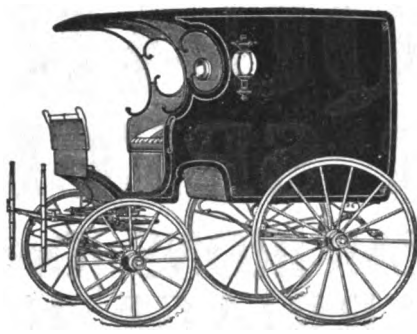

No. 111.—Altman Wagon.

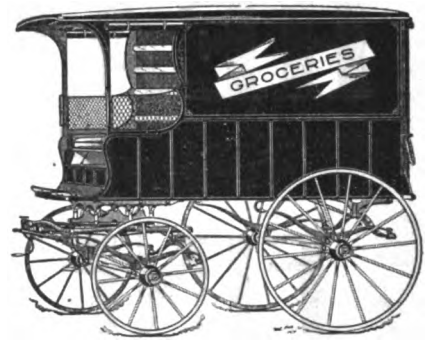

No. 113.—Grocery Wagon.

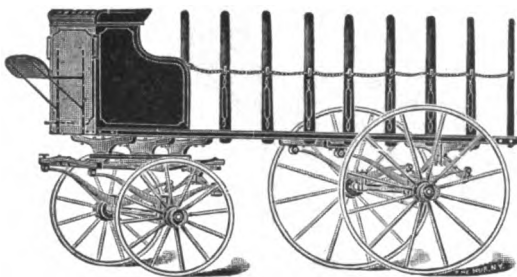

No. 122.—Flour Truck.

Electrotypes

of the vehicles presented on this page will be forwarded on receipt of

75 cts.

for each cut, to any address. Postage prepaid.

Catalogue

containing nearly 200 illustrations of carriages, wagons, sleighs, and miscellaneous cuts will be sent upon application.

Trade News Publishing Co.
24-26 MURRAY ST.
NEW YORK

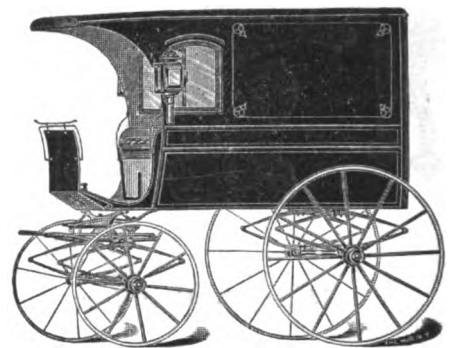

No. 115.—Delivery Wagon.

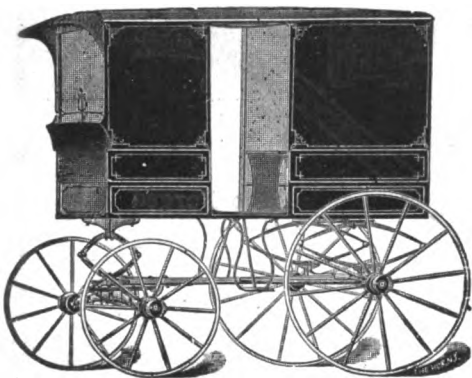

No. 116.—Milk Wagon.

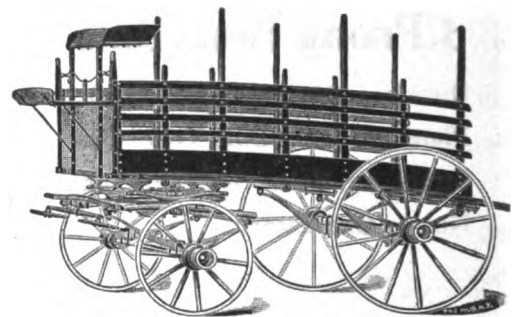

No. 117.—Merchandise Truck.



No. 114.—Delivery Wagon.

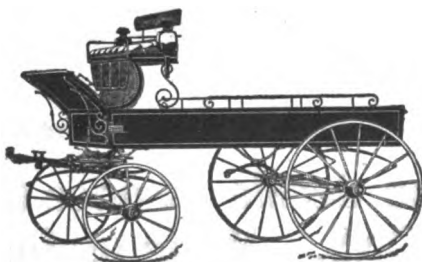

No. 124.—Delivery Wagon.



No. 118.—Ambulance.

Please mention "The Hub" when you write.

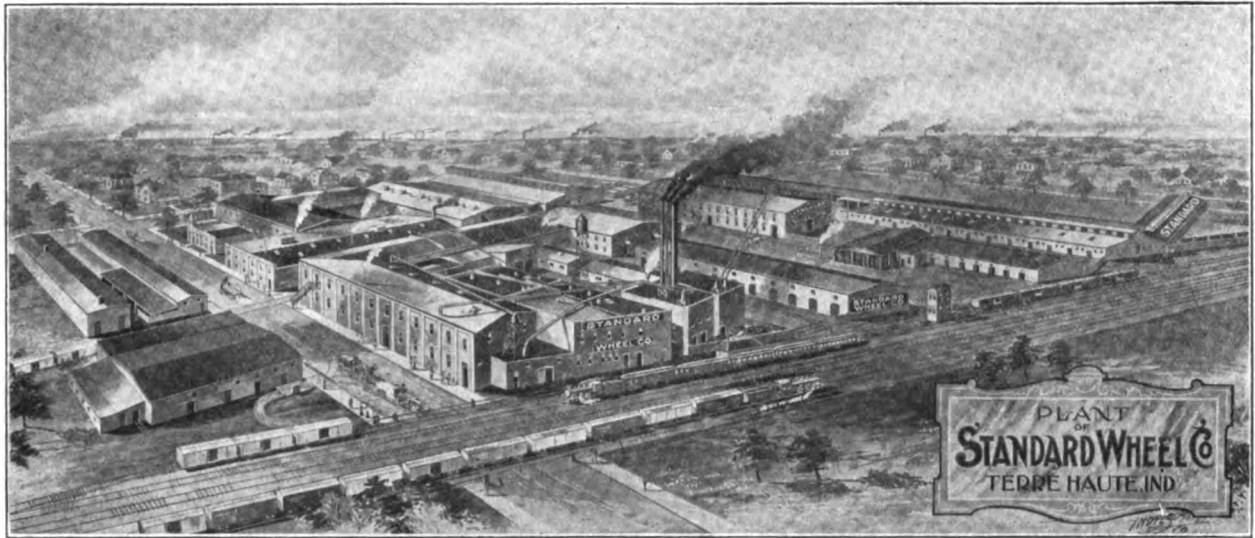

VEHICLE WHEELS AND WHEEL MATERIAL

Three Separate Departments [Light Carriage and Buggy Wheels
Heavy Express Wagon and Truck Wheels
Automobile Wheels

OUR GRADES ARE UNEXCELLED

WRITE FOR LIST.

Terre Haute, Ind. **STANDARD WHEEL CO.** Terre Haute, Ind

Richard Eccles Co., Auburn N. Y.

Manufacturers of

Forgings: Carriage, Wagon, Automobile, Special

Send for Catalogue.

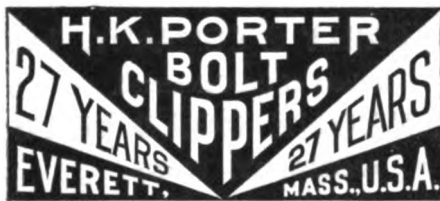

VEHICLES AND GEARS IN THE WHITE



PREMIER SIDE SPRING GEAR

We manufacture a full line of Carriage and Wagon bodies in the white; also Limousine, Taxicab, Touring Car and Roadster Bodies for automobiles in metal. Fifty styles of gears for Carriages and Wagons; also seats, trimmings and tops of all kinds.

Write to us for particulars.

Schubert Bros. Gear Company

ONEIDA, NEW YORK.

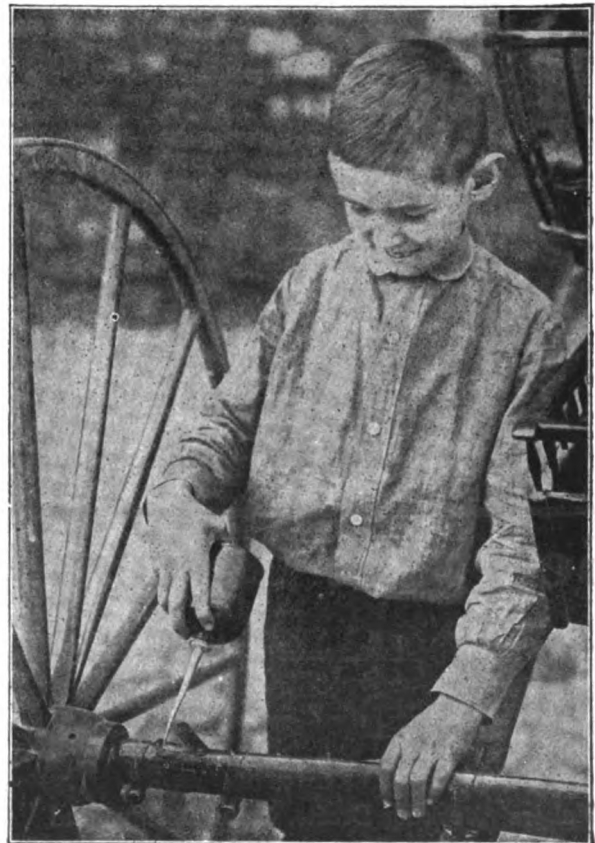

The day of the vehicle that has to be taken to pieces to be oiled is doomed. The ADEN Axle Lubricating Device is inexpensive, simple and effective.

ADEN MFG. CO., Danville, Va.

Please mention "The Hub" when you write.



Meritas Leather Cloth

MERITAS LEATHER CLOTH

You ought to have this sample of **MERITAS LEATHER CLOTH**—the leading low-priced leather substitute.

Made in muslin, duck and drill, glazed and dull finish, smooth or grained in black and carriage colors.

We also issue a special sample book for the Auto trade. Say which you want. Your jobber has the goods.

Standard Oil Cloth Co.
320 Broadway NEW YORK

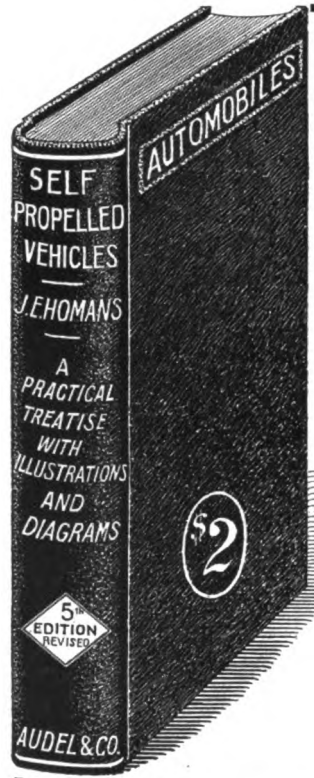

"Self-Propelled Vehicles"

Fifth Edition, Revised.

A practical treatise on the theory, construction, operation, care and management of all kinds of Automobiles.

By **JAMES E. HOMANS, A.M.**

Contains 608 pages and upwards of 500 illustrations and diagrams, giving the essential details of construction and many important points on the successful operation of the various types of motor carriages driven by steam, gasoline and electricity.

This work is now the accepted standard, explaining the principles of construction and operation in a clear and helpful way. This book will be sent postpaid to any address in the United States, Mexico or Canada upon receipt of \$2.00.

Address

TRADE NEWS PUBLISHING COMPANY
24 Murray Street, New York



THE H BOOB WHEEL CO.

Order Your
Wheels, Poles, Shafts and Hardware of BOOB

Steel Tire Wheels, Repair Grade \$ 4.70, Standard Grade \$ 6.70
Rubber Tire " " 12.15, " 15.35

We make all sizes, 3 to 4 in. Tread. We pay freight to our factory and rehubber your old wheels to 30 and up.

Buggy Shaft Ironed, in white \$1.40, Painted \$2.40
Per Set, 16 prs. in white \$4.50
" " Poles Ironed, in white \$3.00, Painted \$3.50
Dry Beveled Rims, per set \$1.40. Spokes per 100 \$2.50.
Cushions and Backs \$1.00 ea. Buggy Tops \$0.50 and up.
Buggy and Spring Wagon Seats, all sizes.

We give 3 per cent. for Cash. Write for our price book on a full line of Carriage and Wagon Hardware, and learn about our special offer. Goods delivered free at your station. Do it to-day or we both lose.

THE H BOOB WHEEL CO., Cincinnati, Ohio.

SAMUEL W. KILVINGTON
HAND-MADE
Automobile Bodies

LIMOUSINES, TOURING CARS and RUNABOUTS DESIGNED TO FIT ANY CHASSIS. HIGH GRADE WORK.

Estimates on Any Style Cheerfully Given.

THIRD AND WALNUT STREETS. WILMINGTON, DEL.

Philadelphia Office: AUTO TOP AND BODY CO., 267-269 N. Broad St.

S. R. BAILEY & COMAANY, Inc.
Makers of the Celebrated.
WHALEBONE ROAD WAGON
AMESBURY, MASS.

George J. Mercer
AUTOMOBILE BODY DESIGNER and DRAFTSMAN

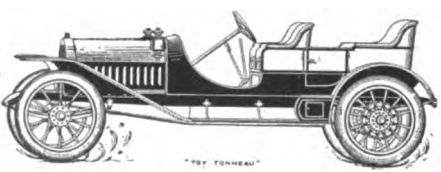

Body Makers' Working Drafts, Color Designs and Scale Drawings of Pleasure and Commercial Automobile Bodies.

Room 401 1777 Broadway, New York

TRUCK BUILDERS

If you only realized the inestimable value of roller bearing fifth wheels on trucks, vans, delivery wagons and all other medium and heavy vehicles, no job would leave your shop without

Roller Bearing Fifth Wheels

WHY? The adjustment is perfect. No oil or grease required. Almost indestructible. Will outwear any vehicle. Saves horseflesh and prolongs life of vehicle. Ask your jobber for the celebrated

NIELSON OR KING

Let us send you Catalogue and Price List.
American Roller Bearing Fifth Wheel Co.
745 THIRD AVE., BROOKLYN, N. Y.

F. W. DEVOE & C. T. RAYNOLDS CO.

101 and 103 FULTON STREET, NEW YORK

Manufacturers of

F. W. DEVOE & CO'S {
COACH COLORS
VARNISHES
BRUSHES
SPECIALTIES

C. T. RAYNOLDS & CO'S {
COACH COLORS
VARNISHES
BRUSHES
SPECIALTIES

FOR PAINTERS, ARTISTS AND DECORATORS

All the brands and specialties of F. W. Devoe & Co. and C. T. Raynolds & Co. will be maintained separately as heretofore.

NUMBER 20 BUGGY SPRINGS

Are for Buggies What Pneumatic Tires are for Automobiles

They are made in one size only and will fit all widths of piano bodies
Graceful in appearance The easiest riding spring on earth

ORDER A SAMPLE SET

THE MULHOLLAND COMPANY,

DUNKIRK, N. Y.

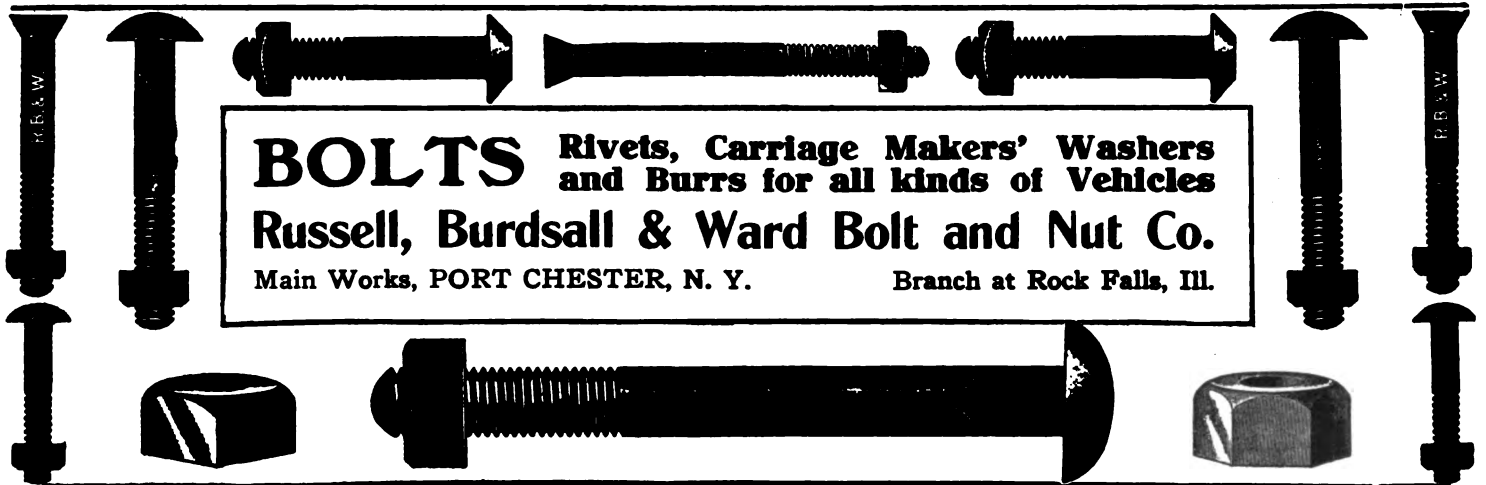

BOLTS Rivets, Carriage Makers' Washers
and Burrs for all kinds of Vehicles
Russell, Burdsall & Ward Bolt and Nut Co.
Main Works, PORT CHESTER, N. Y. Branch at Rock Falls, Ill.

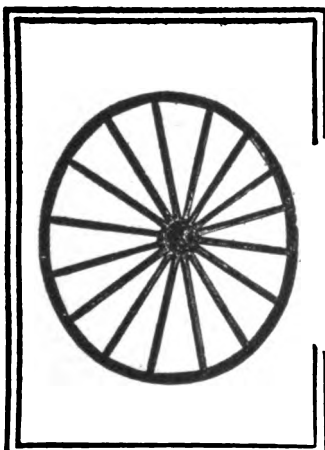

Time Has Told the Story!
Service and satisfaction always follow our rolling stock

WHEELS

ALL KINDS—BEST QUALITY

Also RIMS and SPOKES

The Eberly & Orris Mfg. Co.
MECHANICSBURG, PA.

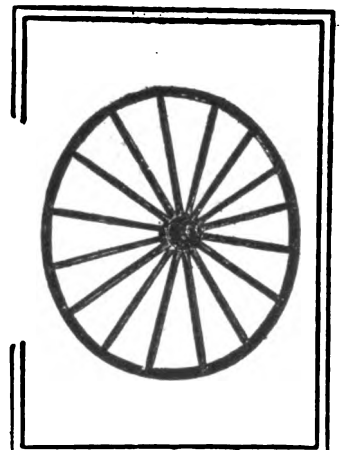

McKINNON DASH COMPANY

BUFFALO, N. Y.

**TROY, OHIO,
CINCINNATI, OHIO.**

**ST. CATHARINES,
ONTARIO.**



No. 329-N.

Our No. 329 N, with nickel rail
is one of our new designs
for 1911

The rail insures the life of the dash

Skewed Shaft Couplings

**Regular or Oval Patterns
For High Arched Axles**

Furnished in rights and lefts for any height of arch. Oval Axle
Clips $\frac{5}{8}$ or $\frac{3}{4}$ width to match Oval Couplings. Bolts, Clips,
Couplings, Carriage Hardware and Special Forgings

Catalogue "H" and Prices on Application.

COLUMBUS BOLT WORKS, Columbus, O.

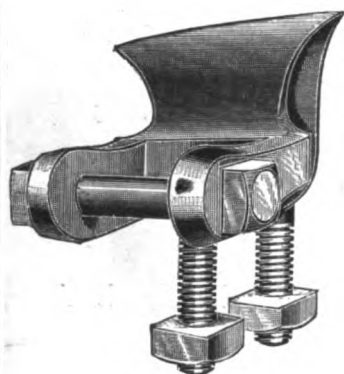

VEHICLE WHEELS OF REAL WORTH

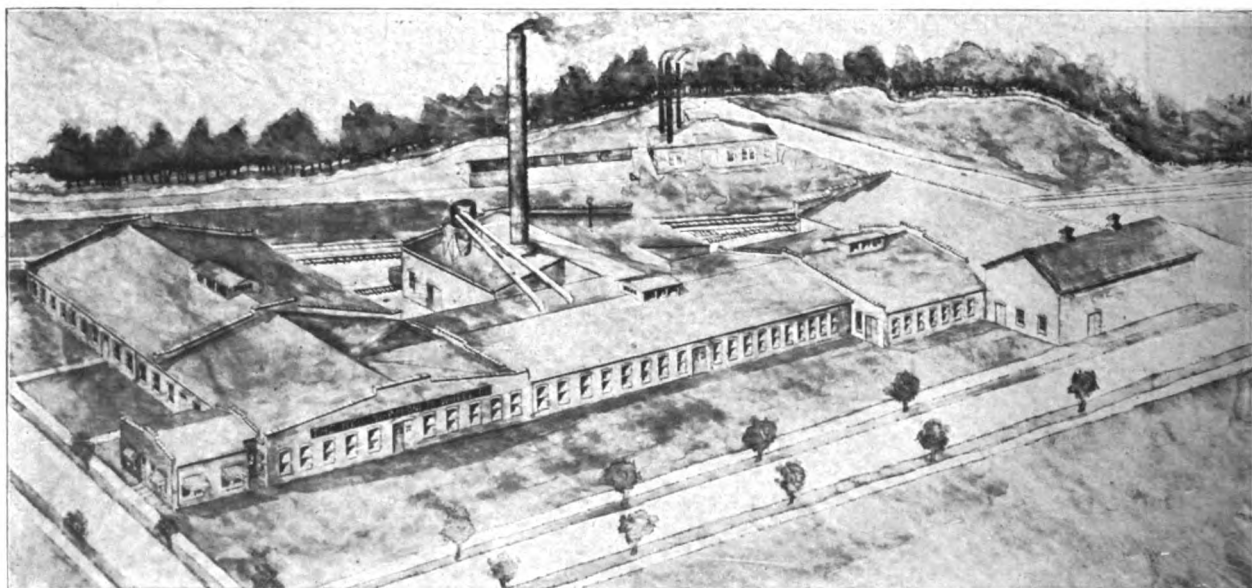

We manufacture Vehicle Wheels of All Kinds; Light and Heavy. Sarven, Warner, Compressed Band
and Wood Hub. Send for our Price List.

THE NEW WAPAKONETA WHEEL COMPANY
WAPAKONETA, OHIO

The Hub

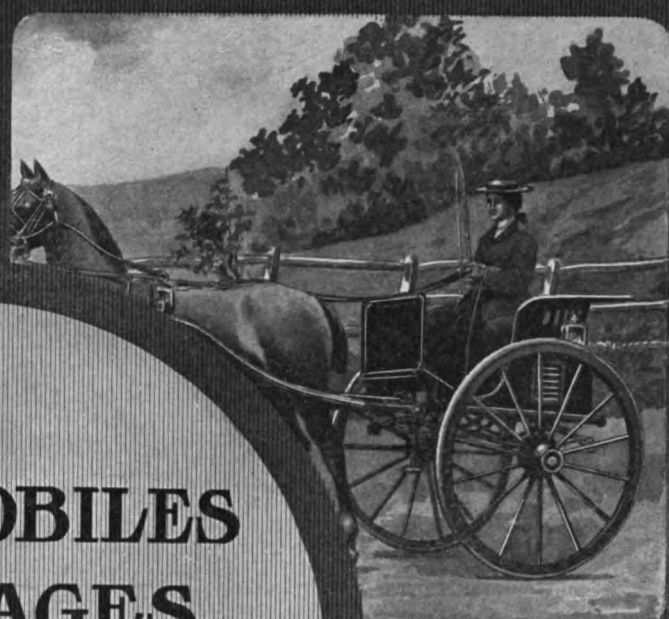

**AUTOMOBILES
CARRIAGES
MOTOR TRUCKS
WAGONS**

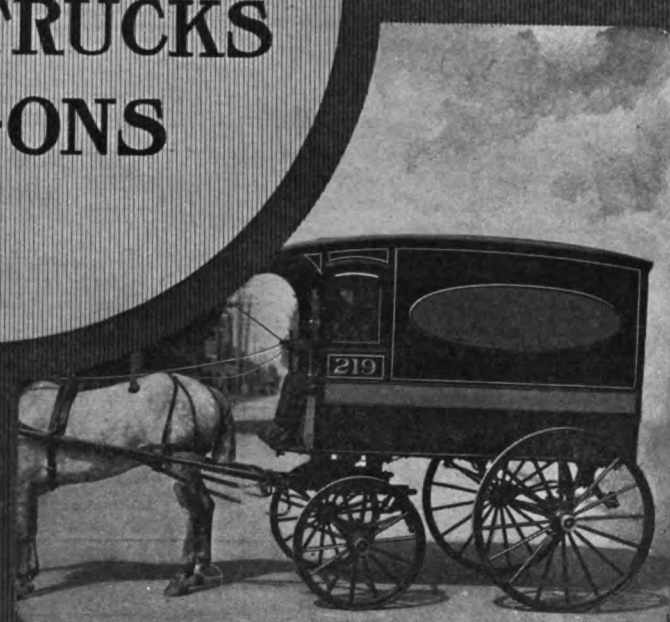
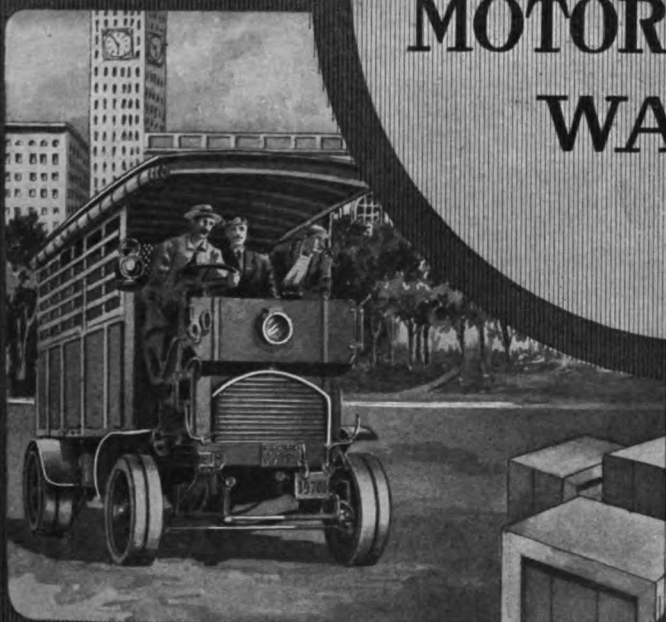

TRADE NEWS PUBLISHING CO
24-26 MURRAY ST., NEW YORK

Hoopes Bro. & Darlington Inc.

West Chester, Penna., U. S. A.

SARVEN
STAR or KENNY
 Sweet Concealed Band
WOOD HUB
WARNER

WHEELS

HEAVY and LIGHT
 for
CARRIAGES
WAGONS and
TRUCKS

IF YOU WANT THE BEST TRY OURS

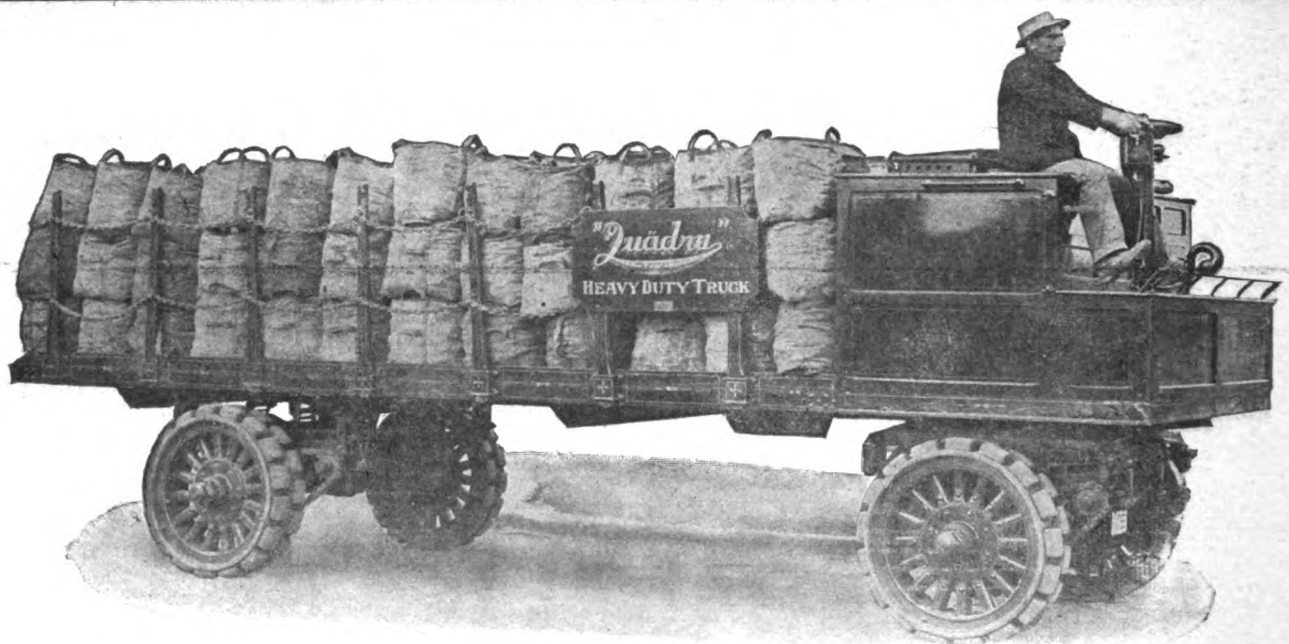

Load—Ten Tons of Coal.

SOLVED! Is the way motor car experts express themselves on the subject of tires for commercial motor vehicles after seeing and using the

KELLY-SPRINGFIELD SECTIONAL TIRE

With a grip on the road that means progress and security from the fault of solid tires—that of crowding the rubber ahead under load, which means disintegration—the motor wagon and truck owner will find in the Kelly-Springfield Sectional Tire the best tire for all heavy cars. Each section is dependent upon itself. If interested, write

CONSOLIDATED RUBBER TIRE COMPANY

New York, N. Y., and Akron, Ohio

Branches: Boston, Chicago, Philadelphia, St. Louis, Detroit, Cincinnati, San Francisco.



CRANE & MACMAHON, (INCORPORATED)

8-10 Bridge St., NEW YORK CITY, U. S. A.

Sole Manufacturers and Exporters of the

HICKORY NUT,  ACORN,  and STAR  BRANDS OF

Carriage, Wagon and Automobile Wood Stock

FACTORIES:

ST. MARYS, OHIO. RICHMOND, VA.

For Export Prices apply to the New York Office.

The Standard Automatic Brush

Does your painting work in a New Way—better, quicker, cheaper, eliminating all waste of paint. An equal flow at all times: thickness of coat can be accurately adjusted. Absolutely clean and fireproof.

Jobbers
and
Dealers
Wanted
Every-
where

Complete Outfit

Consisting of a large paint tank, either stationary or movable, with automatic valve and six feet of flexible tubing, together with the automatic adjustable brush, made of aluminum,

Costs \$7.50

and it is still cheaper than the ordinary brush. The outfit is also made with a tank to be strapped on the back, which will cost \$2.50 extra.

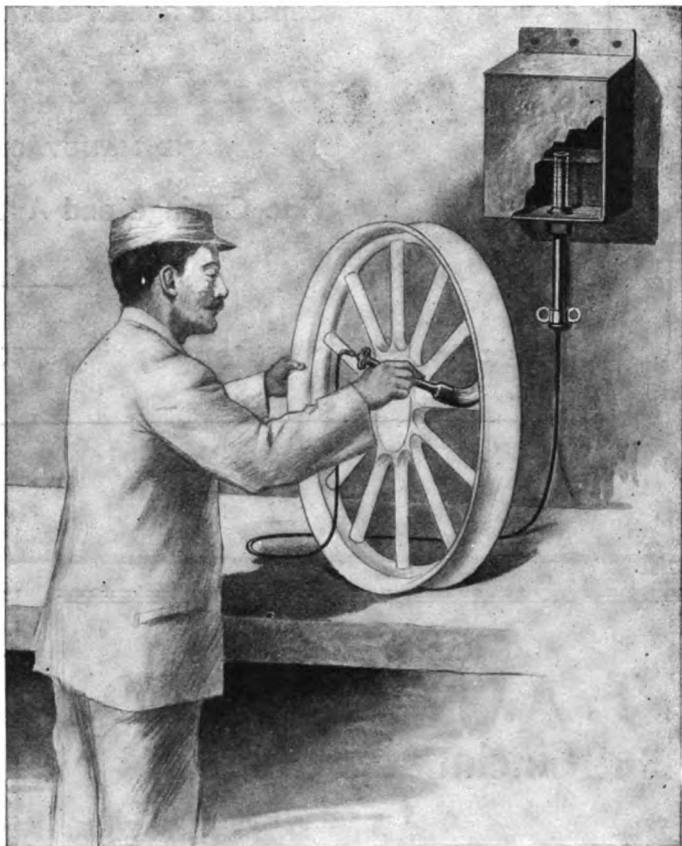

The Standard Automatic System Does Away with the Paint Can

It eliminates the dip and is far superior to the spray, but it does rub it in. No air pressure is needed. Will work with any kind of paint. GET NEXT TO THIS NEW METHOD. Made especially for manufacturers of automobiles, automobile bodies and wheels, all kinds of vehicles, carriages, etc.

Wherever duplication of work exists, this device will increase your output and reduce the cost. Buy just one outfit to-day and be convinced. We are sure that we will have to equip your entire plant.

OUR LITTLE BOOKLET WILL TELL YOU WHY.

Write for one to-day. Send in your order. Your outlay will only be once. Apparatus will last a lifetime. Special equipments can be made to suit your purpose. Let us know what you are manufacturing and we will effect a saving for you.

Standard Automatic Mfg. Co.
50 CHURCH STREET, NEW YORK

JOHN W. MASURY & SON

Originators of

Superfine Coach and Automobile Colors

Acknowledged the Standard for Fifty Years

AND MANUFACTURERS OF

Fine Carriage and Automobile Varnishes

New York, Chicago, Minneapolis, Kansas City

THE
A. T. A. NELSON CO.
Cincinnati, Ohio

Cut Leather

All Sizes, All Grades
Pole & Shaft Straps
Auto Straps

Vehicle Trimming Specialties

WRITE US QUICK

THE
A. T. A. NELSON CO.
Cincinnati, Ohio

JOHN REILLY Inc.

Established 1865

MANUFACTURERS OF ALL GRADES OF

LEATHER

FOR THE
Carriage & Automobile Trade

PARTICULAR ATTENTION CALLED TO
OUR AUTO SPECIAL

FACTORIES,
Avenues C & D, Murray & Astor Streets.
NEWARK, N. J.

AGENTS,
Cincinnati—National Hardware Co., Fourth Street
Detroit—C. W. Findlater, No. 313 Forest Ave., West

THE AULT & WIBORG CO. VARNISH WORKS

CINCINNATI, OHIO.

**SUPERIOR CARRIAGE
AND AUTOMOBILE VARNISHES**



The Quickest Thing in Quick Rubbing Varnish; Saves Time and Trouble
READY TO RUB IN 24 HOURS

**If You Have
VARNISH TROUBLES
Come to us.
We Have the Remedy.**

**Factory: Norwood, Ohio.
Branches:
New York, Philadelphia, Chicago,
St. Louis, Toronto, etc.**



LET US HELP IN SOLVING THAT MANUFACTURING PROBLEM

☛ BY FURNISHING YOUR AXLE EQUIPMENTS IN CARLOAD LOTS AS YOU NEED THEM AND WHEN YOU NEED THEM.

☛ I-BEAM OR TUBULAR FRONTS, CHAIN OR BEVEL DRIVE REARS, CUP AND CONE, ANNULAR OR ROLLER TYPE BEARING.

☛ OUR STANDARD EQUIPMENTS INCLUDE ALL THE IMPROVED TYPES IN USE.

☛ WE ARE SPECIALISTS IN THIS LINE AND OUR EXPERIENCE IS AT YOUR DISPOSAL.

THE AMERICAN BALL BEARING CO.

L. S. & M. S. RY. and EDGEWATER PARK
CLEVELND, OHIO

Please mention "The Hub" when you write.

**Quality Is
Economy.**

*Varnish is a small item in the cost
of a Carriage or Motor Car.
Varnish-Room Trouble is a big item.*

Murphy Surfacers and Murphy Rubbing and Finishing Varnishes save their cost, many times over, in Varnish-Room Reliability—which means the Saving of Time and Labor.

They save the good will of customers also, and that is a special economy.

Murphy Japan Colors go enough farther to make them cheaper than colors at half the price.

The Varnish
That Lasts
Longest

Murphy Varnish Company

FRANKLIN MURPHY President NEWARK, N. J.
Associated with Dougall Varnish Company, Ltd., Montreal, Canada

BOSTON
CLEVELAND
ST. LOUIS
CHICAGO

**WILLEY'S
COLORS**

The **RECOGNIZED STANDARD**



C. A. WILLEY CO.

COLORS GRINDERS

and Manufacturers of Specialties in

CARRIAGE, AUTOMOBILE AND CAR

PAINTS

COLORS, VARNISHES, ETC.

HUNTER'S POINT, NEW YORK CITY

ESTABLISHED 1855

PHINEAS JONES & COMPANY

305-313 Market St., Newark, N. J.

**AUTOMOBILE
WHEELS**

For

PLEASURE CARS and TRUCKS

Repairing and truing old wheels a specialty. Experimental wheels a specialty. We furnish and apply any style demountable or detachable rim or tire.

KEYSTONE BLACK FILLER

MAKES A PERFECT

ROUGHSTUFF

For Automobile Bodies and Parts

It fills the pores of Metal and Wood perfectly. Sandpapers easily and produces a fine smooth surface that DOES NOT CRACK, SCALE NOR PEEL.

POMEROY & FISCHER, New York
Selling Agents to Vehicle Trade

KEYSTONE PAINT AND FILLER CO., Muncy, Pa.

For You The Carriage Dealer

The article that follows is taken from the July number of "Judicious Advertising." It describes very appreciatively what the B. F. Goodrich Company is doing for the Carriage Dealer. If this sort of original and direct advertising appeals to you, the B. F. Goodrich Company welcomes an opportunity to help you present the decided merits of Goodrich Solid Rubber Carriage Tires to the Carriage Owners of your community.

Framing the Dealers' Campaign

"THE business of getting close to the dealer, one phase of which was exploited in the June number of 'Judicious Advertising,' is shown in this campaign in concrete form. "The campaign was first worked out with the firm of Harrah & Stewart Company, Des Moines, Iowa, one of the large number of Goodrich dealers. It consisted merely of follow-up matter to the carriage owners of Des Moines, the idea be-



"In Des Moines Prosperity is a Habit."
—Walth

ing to hammer home the thoughts in the dealers' advertising locally. The work of the Goodrich Company for its dealers exemplifies a basic business principle that is of tremendous importance to manufacturers all over the country.

"For the Des Moines dealers, the advertising department undertook the planning of an advertising campaign which would present the advantages of their service and of the Goodrich product. To the carriage owners of Des Moines one of these leaflets will be sent out each month.

"It was sought to make the advertising very local—something that would appeal to every loyal citizen in Des Moines. Therefore, 'The Des Moines Idea'—that is to say the keen public spirit of Des Moines people—suggested itself as a motive.

"A great deal of care was taken with the drawing on the leaflet, to reproduce those scenes which would interest the citizen and which would

beget attention. The phrases from 'Wealth,' the publication issued by the Greater Des Moines Committee, and featured in its national advertising campaign, were the cue for the talk which followed on the inside of the leaflet. No suggestion was given in the outside as to what was contained within, yet care was taken to make the connection between the two logical and clear. In other words, this experiment was undertaken with the idea of putting the advertising matter of one firm in the community on a higher plane than is customary—that is, to attach it to the broader interests, to the interests of the community as a whole, and thus to make it social, and give it, so to speak, an ethical quality.

"It identifies the interest of the individual buyer looking out for himself, with the broader interest of the whole body of buyers—that is, with the City of Des Moines.

"The feat of taking advantage of the national advertising of the city of Des Moines, naturally,



"Life is Worth Living in Des Moines"
—Walth

Livingman Boulevard.

was bound to attract tremendous interest in the leaflet to the Des Moines carriage owners, into whose hands the matter went.

"Such ideas promulgated for the benefit of the dealer are bound to cement the manufacturer's relation with him, and after all, that is the process which sells most goods. Such exhibition of good feeling for the dealer accomplishes results along lines of easiest resistance."

Tell Us What We Can Do For You. Address

THE B. F. GOODRICH COMPANY
AKRON, OHIO

463

This is the whole number of vehicles exhibited
 Madison Square Garden Grand Central Palace
 Jan. 7-21 (Two Shows) Dec. 31 - Jan. 7

463

Trade **VALENTIN** **ISHES** Mark

70%+

This large percentage of all vehicles employed

Valentine's Products

70%+



The WEST Hydraulic Tire Setter
 WILL CUT DOWN EXPENSE

Tires set cold in one minute. This machine saves time — does the work better and quicker, does away with burned streaks. Only necessary to measure one wheel in a lot. Does not char the rim and

thus make the tire loosen prematurely. Gives re-sandpapering of wheels.

This machine is now increasing the profits of many manufacturers. Send for catalog and read about it.

WEST TIRE SETTER CO., ROCHESTER, NEW YORK

Jones Wheels

BEST ON EARTH

KANTSAMORE

Phineas Jones & Co.

Newark, N. J.

MOLLER & SCHUMANN COMPANY

COLORED RUBBING

Most perfect as to working, drying and wearing.

CARRIAGE & AUTO VARNISHES

Send for color card and descriptive price list.

Chicago Branch - 110 N. Desplaines St., Office and Factory - BROOKLYN, N. Y.

The

Hub

Copyright, 1911, by the Trade News Publishing Co. of New York.

Entered in the New York Post Office as Second-class Matter.

Vol. LII.

FEBRUARY, 1911.

No. 11.

THE TRADE NEWS PUBLISHING CO. OF N. Y. Publishers of THE HUB

J. H. WRIGHT, *President.*

G. A. TANNER, *Secretary and Treasurer.*

24-26 MURRAY STREET, NEW YORK.

Other Publications of Trade News Publishing Co.:

HARNESS (monthly) per year, \$1.00
AMERICAN HARNESS AND SADDLERY
DIRECTORY (annual) per copy, \$4.00

THE HUB is published monthly in the interest of employers and workmen connected with the manufacture of Carriages, Wagons, Sleighs, Automobiles and the Accessory trades, and also in the interest of Dealers.

Subscription price for the United States, Mexico, Cuba, Porto Rico, Guam the Philippines, and the Hawaiian Islands, \$2.00, Canada, \$2.50, payable strictly in advance. Single copies, 25 cents. Remittances at risk of subscriber, unless by registered letter, or by draft, check, express or post-office order, payable to the order of TRADE NEWS PUBLISHING CO.

For advertising rates, apply to the Publishers. Advertisements must be acceptable in every respect. Copy for new advertisements must be received by the 25th of the preceding month, and requests to alter or discontinue advertisements must be received before the 12th day of the preceding month to insure attention in the following number. All communications must be accompanied by the full name and address of writer.

FOREIGN REPRESENTATIVES:

FRANCE.—L. Dupont, publisher of *Le Guide du Carrossier*, 78 Rue Boissiere, Paris. Subscription price, 15 francs, postpaid.

GERMANY.—Gustave Miesen, Bohn a Rh. Subscription price, 12 marks, postpaid.

ENGLAND.—Thomas Mattison, "Floriana," Hillside Avenue, Bitterne Park, Southampton. Subscription price, 12 shillings, postpaid.

Why the "Parts" Man Should Flourish.

The large factory in which everything is done that is needed to be done is an unweildy organization. It is said by those pretending to exact practical experience that such condition is most always an expensive one. One critic even goes as far as to call them "vampire" departments.

The specialist overcomes this loss of friction, if we may so describe it. His work is under closer supervision, because his operations are not of the unweildy kind. His expense is kept well within bounds, because he can more closely watch all the leaks. This close observation of manufacturing detail also prompts improvements that are quite overlooked in the very large plant, unless it happens to be a congress of little plants under a separate specialist supervision.

There is less time wasted by the specialist in his factory of "parts" making, as he does not have to have any elaborate system of cards and tickets that have to be written on a trot along with the job in its progress to completion, in the effort to keep track of very complex transactions. This card-index kind of record is a great consumer of the time of the employed.

We think we notice more perfection of detail, more results of concentrated thought, and more progress in in-

vention in the products turned out by the parts maker than we find coming from the factory that covers a ten-acre lot. We are inclined to ascribe it to this closer supervision. Even a general manager who is a genius, is merely physically human, and has to apportion his genius in joblots all through the factory. The mantle is sure to fall on some inefficient shoulders, and the question isn't answered until it turns up in the concrete form of an expensive mistake.

We believe we have noticed that the good thought and progressive work emanates from the shop of the specialist.

Possibilities of the Electric.

The storage battery for vehicular use has had a very jagged career. At the inception of its use for the purpose it made great promises, and it seemed the ideal propulsive power. But it failed to keep its promise. It appeared to be unable to withstand the vibratory hard usage to which road travel subjected it to. Also it was very heavy. And it seemed out of the question to count upon any stable quantity of mileage.

The early cars so equipped were put out of commission in short order. The doctor was the great sufferer, as the electric appealed to him very strongly. In a little while, however, they were donated to the scrap pile in large quantity.

Mr. Edison never lost faith in the possibilities of the power, and as he had a long purse and infinite patience, he made experiments without number to find out what was the matter.

His problem was to make a battery that should be light in weight, almost vibration-proof, and to hold charge enough to do a day's work. Every little while we heard that the problem had been successfully solved. Not from Mr. Edison directly, but from someone who had visited the inventor, usually a reporter who needed a story, and which was full of more imagination and hopefulness than fact. Every little while we were enthused and saw the thing accomplished, but we never saw the vehicle running about the streets.

We suppose that no one but Mr. Edison will ever know of the many hundreds of experiments that were made. It is said that a reporter asked him if he had wasted all the time on the thing that he was said to have wasted, and it is also said that he answered, "What, do you call it a waste of time to find out nine thousand things that won't work?" This may be apochryphal, but it sounds like the dogged perseverance of the genius.

Now, the real storage battery of commerce seems to

have arrived. It is light in weight, and can make a run of over 200 miles on a single charge of current. It takes the roads as it finds them, and comes up smiling at the end of the day in good working order.

One of the test runs did 120 miles at an expense for charge of \$1.42, or 3-5 cent per mile. This verges on the wonderful.

We may now expect to see a very great sum of activity in the electric vehicle industry, both from its pleasure and commercial aspects. It will not be confined to cities, but will be active everywhere it is possible to find some power station with a charging plug handy, and power for sale.

This character of vehicle is quite to the taste of the vehicle builder, as he is well equipped to do about all the work necessary to turn out the finished vehicle. It is a kind of vehicle that makes a strong appeal to those who like the quiet running, free from complication of machinery. It appeals to others who are nervous about the management of a car that has many levers and pedals to keep in mind at stopping and starting. It is an ideal car for women to drive.

The battery-equipped commercial car will look good to owners who think it can be well managed by a driver who has no natural bent for machinery. Many cars are already in the field doing work that is reported to be satisfactory.

It is no disparagement to the internal combustion motor, but rather an aid to its successful introduction in the same field. Shakespeare was no authority on the autocar, but he was a past master on human nature, and he said that "use doth breed a habit in us," which will become the best school to convert the whilom driver of the horse to a new use for his activities.

In both fields of power propulsion it seems to us that the time of the vehicle builder to assert himself to his profit is at hand. We hope he will see it in the same light.

Inanimates Responsible.

Recently in England an autocar and a buggy were haled to court as witnesses in a fatal accident case.

This is like the old law of deodand. By the application of the statute "guilty" (!) carts were forfeited to the king. If the cart ran over some one and killed the someone, it was forfeited outright. If the man should have suffered a fatal accident climbing into the cart by the wheel, then only the wheel was "guilty" and forfeited. This law was not taken off the statute books until 1846.

Metric Drawbacks.

The inch is so widely used in English speaking countries as a standard of measure, and the metric system finds such slow work in introducing itself, that it has been suggested it might not be a bad plan to increase the size of the meter so as to make it 40 inches, exact. This plan would make 25 millimeters the exact equivalent of one inch, which would make interchangeable measurements easy for those whose prejudice inclined them to the English standard.

Metal Wheels.

If the scarcity of hickory scare keeps up, the consideration of metal wheels, wire, cast spoke and disc, will come forward.

On many of the heavy autowagons for business, we notice a prevalence of cast-spoke wheels. This construction, with solid tire, should produce something heavy enough to let the engine know it was pulling something.

The disc wheel is lighter, and we presume fully as sturdy, but it looks too much like the shield of the Roman soldier to be very attractive.

Somehow, notwithstanding lack of hickory supplies, there is always a supply of wheels, so it is not yet time for the man desiring wheels to become stampeded.

The wire suspension wheel is growing in favor in other countries for light and semi-light cars, especially for the pleasure cars. This is a strong wheel when well made and gives a brilliant account of itself in smash-ups.

So long as we can procure good second-growth hickory at a price that makes such stock available we do not expect to see any change in the material for wheel-making, but we would like to note an increase in height of wheels just for comfort's sake.

"Holding Out."

From our contemporaries who are friends of the farmer and implement dealer, we learn that the farmer is not quite satisfied with the present market price of corn, so is storing grain in the hope of seeing a better day.

This seems to be working a hardship on the vehicle and implement dealer, and its reflex action on the buggy maker cannot be of the pleasantest.

The banks are said to be loaded to the guards with farmers' paper, and renewals are said to be frequent.

The dealers are resorting to many plans to overcome the strain, but nothing that is generally adaptable has been invented.

This is a condition that may become more than unpleasant in certain contingencies.

French Cars for Manila.

It seems the public works department in the Philippines thinks the French de Diva cars rather a cut above the American brand, as it has purchased a lot comprising three 8-cylinder, 50 horsepower cars for mail and passenger service; four 40 horsepower trucks; one double-decker 34-passenger auto-bus, a duplicate of the auto-buses used by the Fifth Avenue Coach Co. on Fifth Ave., New York, and four trailers of two tons each carrying capacity.

Another Ten Off.

The prices of tires are coming down in sympathy with the slump in raw rubber, and it is thought that before springtime yet lower prices will be quoted.

The tire makers are quoted as looking for a staple level of \$1.20 for rubber, but we should judge it is not prudent to look for stability at any figure, owing to the continuing new sources of supply coming in.

Vehicle Fashions for February 1911

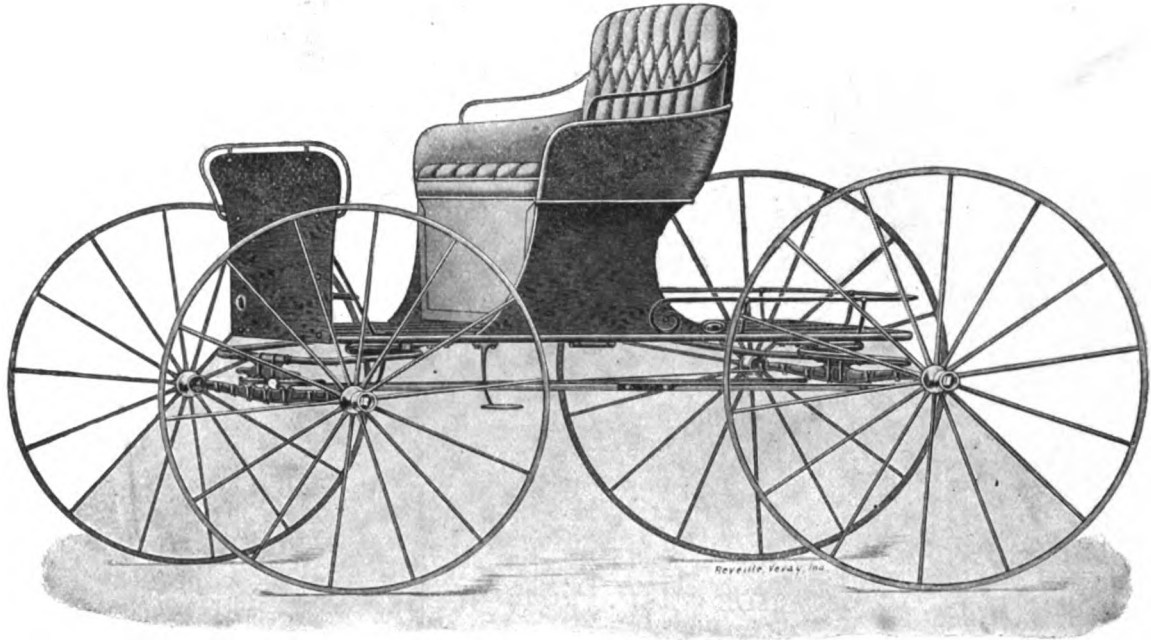

SINGLE BUCKBOARD
Built by Lull Carriage Co., Kalamazoo, Mich.

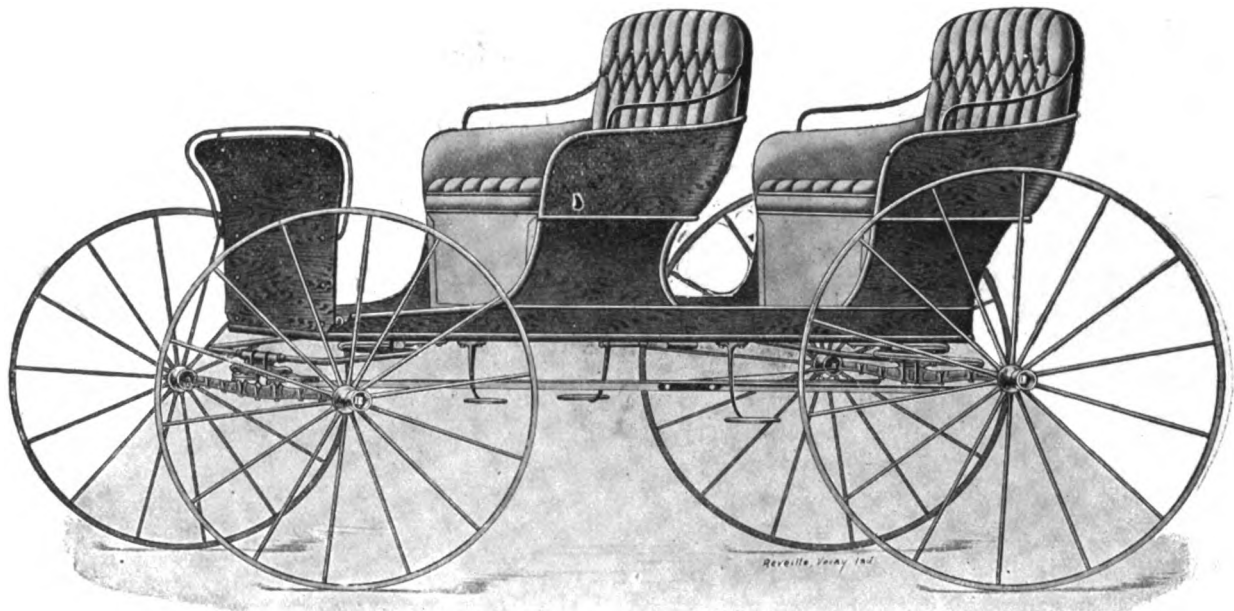

FOUR PASSENGER BUCKBOARD.
Built by Lull Carriage Co., Kalamazoo, Mich.

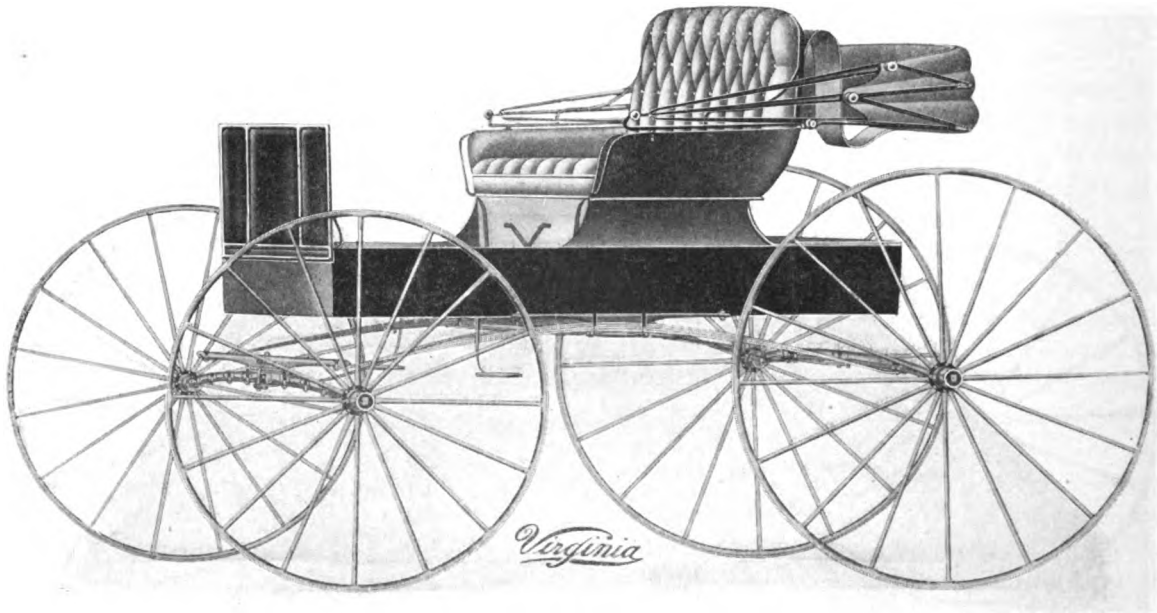

SIDE SPRING TOP BUGGY
Built by Virginia Buggy Co., Franklin, Va.

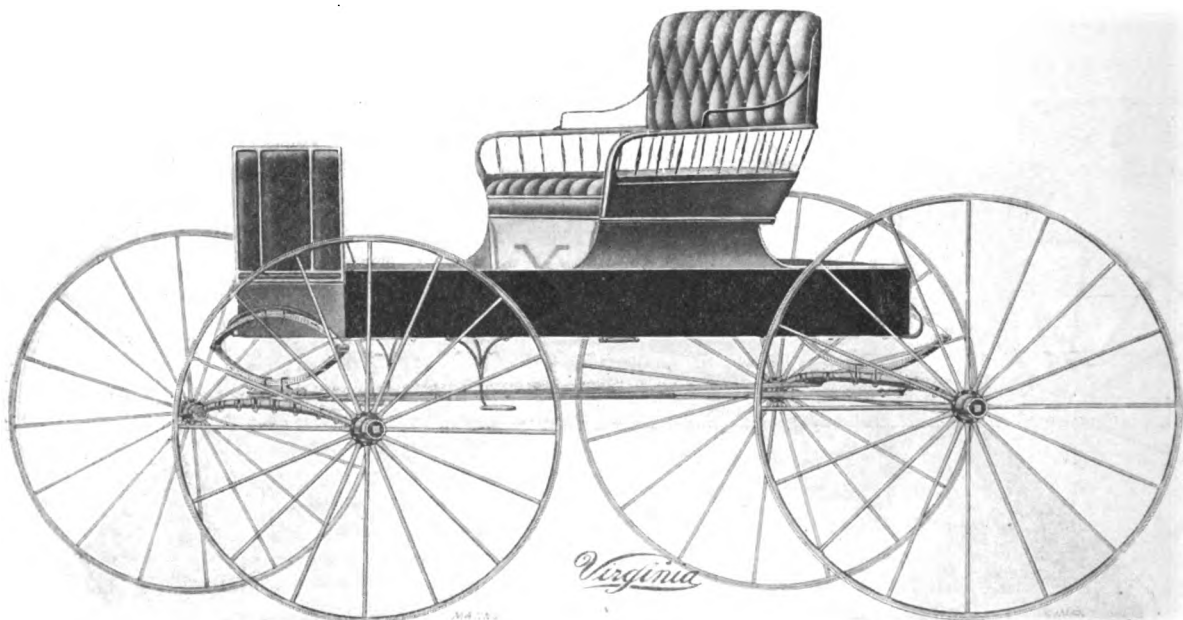

HALF-STICK-SEAT ROAD WAGON.
Built by Virginia Buggy Co., Franklin, Va.

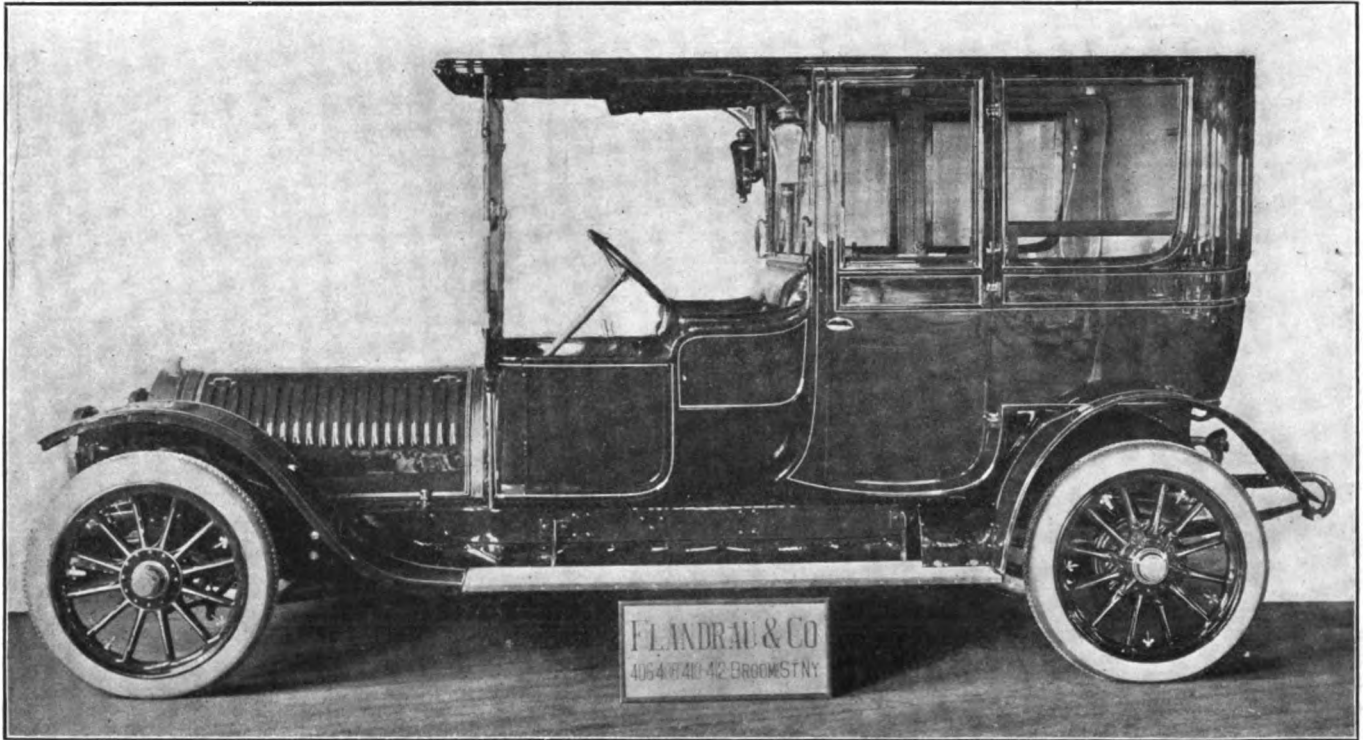

WOOLWORTH LIMOUSINE
Built By Flandrau & Co., New York.

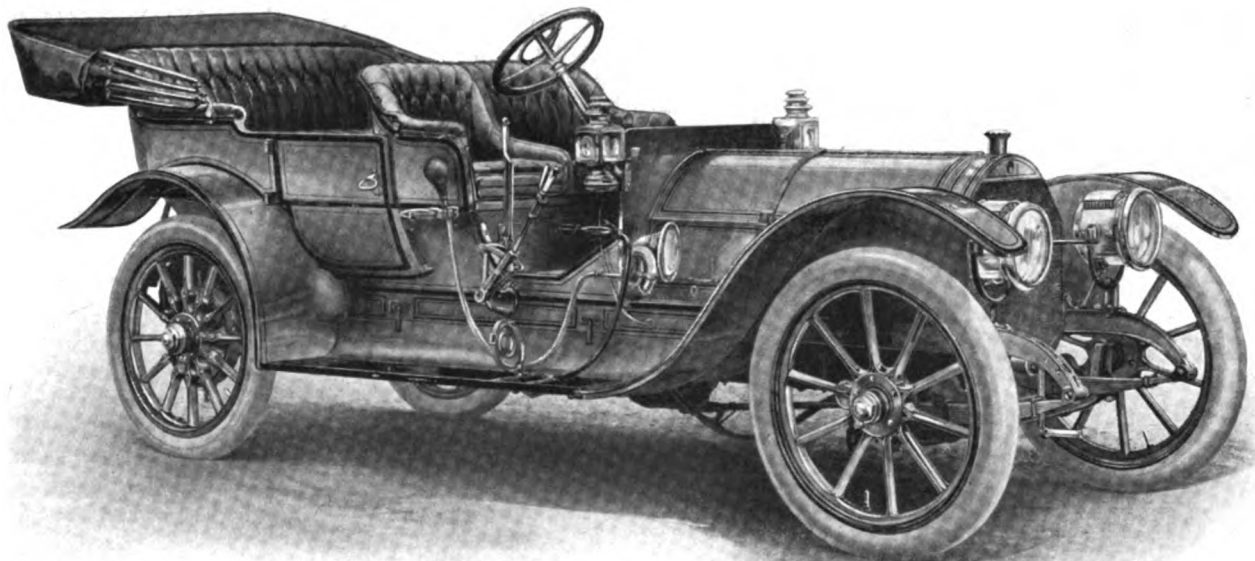

SIX CYLINDER TOURING CAR.
Built by Matheson Automobile Co., Wilkes-Barre, Pa.

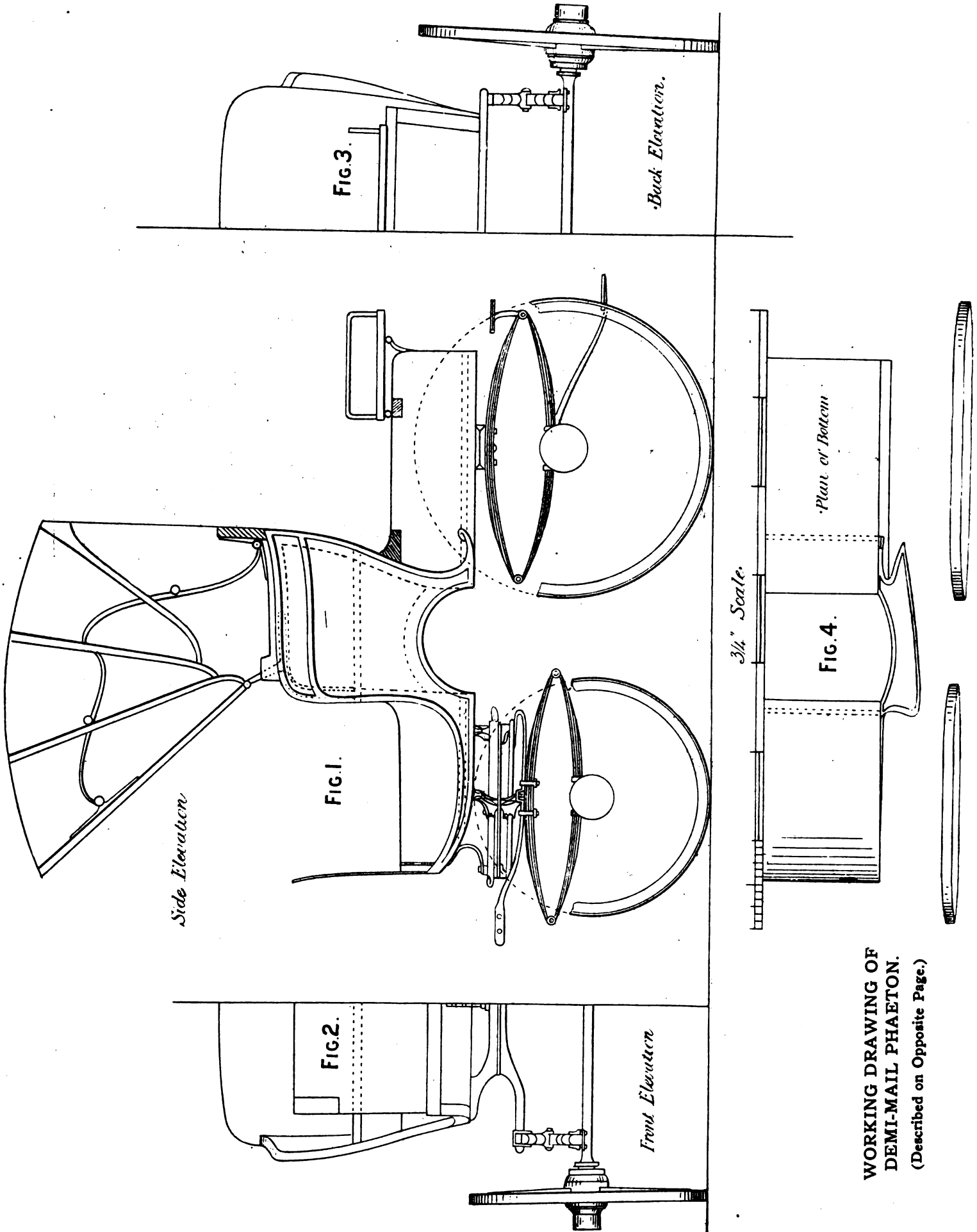

**WORKING DRAWING OF
DEMI-MAIL PHAETON.
(Described on Opposite Page.)**

Wood-working and Smithing

WORKING DRAWING OF DEMI-MAIL PHAETON

(Drawing on Opposite Page.)

The working drawing of the four wheel carriage we bring under the notice of our readers is from Cooper's Vehicle Journal. It is a design characteristic of what is best in high-class work of stylish appearance, more or less an adaptation of the old-time mail phaeton or demi-mail phaeton.

Design—It will be seen that the whole of the lines of the full deep quarter panels of the front seat, the lower arch and footboard brackets are distinctly curvi-linear in character, which is a pleasing contrast to the angular outline generally associated with this class of body. The hind corner pillar is of the well known "Britska" or "O. G." pattern; the front pillar is the ordinary sham door, mail phaeton pillar, with a "swelled" top, the lower part being curved round, to run into a line with the top part of the swept bracket. The elbow connecting the two pillars, back and front, has a gradual rise at the hind part, the front curved over on the top that permits of the false overhanging elbows that carry the head being easily fitted. The measurements and general proportions of the side quarter allow of a comfortable seat, with every protection to the occupant, while the size and arrangements of mouldings following the outline of body and arch, and the double elbow moulding, materially add to the general appearance of the complete quarter.

The rounded arch and front enclosures or doors are both somewhat uncommon features, but will be found a decided improvement, the one in permitting of a low hung body, the other complete protection for the feet and lower part of the dress. The folding hood is arranged of a comfortable height.

The head in this design is of a regulation height, the front stick well forward in a line with the dash; the back hoopstick is so arranged that sufficient clearance exists between the head lining and occupant, without in any way interfering with the set and appearance of head. The hind boot sides, though somewhat shallower than usual, lace supporting the overhanging groom's seat, the top corners of boot sides being rounded consonant with the general character of the body. The body is mounted on elliptic springs with open futchell under-carriage with light hickory wheels, and whether seen with head up or, as more frequently, with the head down, is a most attractive looking carriage.

Construction—On a reference to Fig. 1, which represents the side elevation of the body mounted, showing all the structural details of the body, it will be seen that it is mounted on wheels 3 feet 5 in. at the hind part and 2 feet 8 in. in front, the bottom of body, 2 feet 8½ in. from the ground, with the futchells of forecarriage arranged to render the carriage suitable for a cob 14 hands, or would, of course, look infinitely better when worked with a smart pair of cobs, pole and bar fittings being generally arranged in a carriage of this description. If desired, the design can with little trouble be proportionately increased in size that horses 15-2 to 16 hands can be used; either case is resultant in a smart turn-out for a gentleman's driving phaeton. Besides the body being hung low, the wheels are closely coupled to the compass bed with a forward perch bolt, though axles front and back are of the same length over collars, allow the wheels to lock well under and safely clear the back of the arch. The position of the hind wheels, together with the space between the body and the wheels, is ample, with the aid of the double step, of safely getting to the hind seat when the carriage is in motion, also there would be no difficulty, if required, in fitting an ordinary lever brake, should the carriage be used in a hilly district.

The construction of the body gives a comfortable seat for two persons, the use of footboard brackets give the leg room in

length, that firmness is given to the driver when sitting in a deep wedge cushion or a cushion and driving box, common to these carriages.

Long, easy elliptic springs back and front, those in the front carriage stayed and set to give the ease required, and at the same time sustaining power, the hind connected to hind carriage bar that adds somewhat to the steadiness of working, owing to the increased width of bearing for the springs.

Materials—The sham door and front footboard brackets will take 3 in. plank; with care the hind corner pillar elbows can be cut from 2½ inch plank, the pattern for hind corner pillar being made up to take the scroll end and the lower part of arch moulding. The hind seat bar and back rail should be cut from 2 in. plank; but the bottom sides and cross framing bars, with the seat rail, can all be got out of 1½ in. stuff, while 1 in. plank is necessary for the framing of the hind seat. Besides the wood described for the panels we shall require a 4-stick Victoria corner hood. For the boot sides either birch or mahogany ¾ inch thick, cut from a board 14 inches wide, to work up the front curve and bevel of sides.

The arch of body is strengthened by a 2 in. by ¼ in. steel edge and 3 in. plank for axle and transom beds; but the horn bar can be cut from 2 in. stuff, while 1½ in. ash will be required for framing piece, felloe pieces and futchell blocks.

The arch of body is strengthened by a 2 in. by ¼ in. steel edge plate, with flaps turned along the bar, but in place of the usual half-round bracket plate, an ⅛ by 2 in. flat iron plate extending from the toe of bracket to the sham door joint. It is then split with the inside piece turned down flat to take the carriage hanging bolts, 1¼ in. wide, the extra ⅝ in. extending up the pillar as far as the top of door or enclosure. In fixing this plate it is screwed standing in from the outside a full ¼ in., furnishing a rebate for the door to shut. The head fittings are shut in the solid with the ¾ in. half round iron corner plate that is fixed on the inside of seat.

A set of neck plates, ¾ in. head joints and the usual prop nuts, the back one forming a stout corner plate, fixed on top of false elbow, with the half-round flap along the back rail. The measurements and other details connected with the springs, axles, and wheels are fully described at the end of this description.

Framing—The front brackets are got out to the pattern, the lap on the inside for the back bar cut ⅝ in. thick, also rebated for the bottom boards. The framed bottom for the boot sides can be made up to hang the body to a width of 2 ft. 7 in. The boot sides are rebated on to the bottom, the sides having a ¼ in. lap or outside flange, therefore the bottom will be required 2 ft. 6½ in., outside edges beveled to the sail of the sides. The hind corner pillars are shouldered down a ¼ in. on from the inside, the outside flap being halved, with a vertical joint ⅞ in. thick, to give the pillars a width of 3 ft. 3 in. at the elbow. They are secured by screwing from the underside up into pillar, also with a screw on the outside in the boxing out for the panel. The front sham door, having been got out to the shape and gauged to hold up 1½ in. in thickness, is shouldered down with a bare faced tenon on the inside. This pillar is also secured by screwing both from the under side and inside. In framing this pillar to the bottom side, the bottom part must be shot off to a bevel that will give the pillars a throw out of 5¼ in. aside, thus bringing the body to a width of 3 ft. 6½ in. on the bottom of sham doors, the width on the bottom across the brackets at this point being 2 ft. 8 in.

The elbow is lapped on to the sham door from the inside on to the corner pillar on top on the outside, each being secured by screws; the neck pieces to form arch are preferably made in two

spliced in the centre, and as only a narrow $\frac{3}{8}$ in. moulding is recommended to be shown round the arch, a small vertical joint only shows, the framing being boxed out for the mouldings and grooved for the panel, after being put together, is strengthened by a vertical batten. The two seat rails are stump-tenoned into the pillars, the seat boards being simply nailed on, but, of course, fitted "off" the panel. The back rail is shouldered down on to the top of elbow and screwed. Care should be taken in putting in the quarter panel; the grain being in an horizontal direction, will take a 28 in. board. The panel is preferably canvased before putting in, and canvased blocked afterwards. The supplementary or double elbow moulding should be cut out of ash and screwed on from inside. The hind seat should be framed to the sides given and fixed as shown in the drawing, the back of boot sides being framed in the ordinary Stanhope phaeton style. The particulars of the hood also being given, it is only necessary to add that the ironwork, besides carrying the head firmly, is also equally necessary for the strength of the body. The front doors can either be framed or made out of $\frac{3}{8}$ in. birch with $1\frac{1}{4}$ in. ends, clamped on flush on the outside, hinged to a pillar piece in front, rebated on the edge to fit in the recess caused by fitting back the bracket plate. The front of body is then finished with a quarter panel, but can, of course, if desired, be left quite open to the dash, the door being trimmed on the inside with patent leather. A smart natty finish to the front is made by making an oval iron frame covering, as in a wing with patent leather, and hinging this with the addition of an enamelled leather apron or knee boot, which, with the hood up, gives all the required protection in bad weather. Fig. 2 is the half front of body mounted, giving all the width on the seat, also the exact shape of the sham door pillars and sweep of back rail. It also gives the lightening out of the axle and transom beds of the forecarriage, together with the track of the front wheels.

Fig. 3 is a similar view of the hind part of the body mounted, showing the length of hind seat and fixing of hind springs and the track of the wheels.

Fig. 4 is the plan of the bottom of body from wheel; the widths of bottom can be taken, and the side sweep on the elbow.

Undercarriage—The compass beds forming the underworks are plated in the usual manner, top and bottom; the horn bar, supporting the back of the wheel plate, should have an $\frac{1}{8}$ in. plate flat iron screwed throughout its entire length. The wheel irons are fitted with back stays to support the futchells, which are pitched to give a $1\frac{1}{2}$ in. felloe piece at the back, $1\frac{1}{2}$ in. in front. A reference to the side elevation of the body in Fig. 1 will show the exact position of the wheels when on the lock, in their relationship to the arch. This is an important detail in this class of vehicle. The double step and their fixing at the hind springs can be seen, as can all other particulars of the body, and undercarriage, from the drawings, which, being to scale, can be quickly ascertained. The following are the principal measurements of body and undercarriage:

Body Dimensions—Length of body on bottom side to arch, 2 ft. 8 in.; length of bracket bottom side measured square, 2 ft.; rise of toe of bracket, $4\frac{1}{2}$ in.; span of arch on bottom, 1 ft. 2 in.; depth of arch, 7 in.; depth of body sides over all at hind pillar, 2 ft. $4\frac{1}{2}$ in.; depth of body sides at sham door pillar, 2 ft. $2\frac{1}{2}$ in.; length of body on seat line, 1 ft. 9 in.; depth of boot sides, 11 in.; depth of front doors, 8 in.; width across bottom of body at boot sides, 2 ft. 7 in.; width across the top of boot sides, 2 ft. 10 in.; width across the seat inside of sham doors, 3 ft. 2 in.; width across the sham door pillars on top over all, 3 ft. $6\frac{1}{2}$ in.; width across the corner pillars on seat outside, 3 ft. 1 in.; width across the corner pillar at elbows, 3 ft. 3 in.; height of body seat from bottom boards, 1 ft. 2 in.; head room measuring top of seat boards to underside of hoopstick, 3 ft. 10 in.; length of head on top, 4 ft.; compass of the head on top, 5 in.; length of hind seat frame, 2 ft. 5 in.; width of hind seat frame, 1 ft. 3 in.; height of dasher frame, 1 ft. 8 in.; height of bottom of body from ground, 2 ft. $8\frac{1}{2}$ in.

Wheels—Height of hind wheels, tired, 3 ft. 5 in.; diameter of hub, $6\frac{1}{2}$ in.; length of hub, $6\frac{1}{2}$ in.; spokes, 1 7-16 by 1 1-16; felloes, width, $1\frac{3}{4}$ in.; length of front stock hoops of hind wheels, 2 in.; height of front wheels, tired, 2 ft. 8 in.; diameter of hub, $5\frac{7}{8}$ in.; length of hub, $6\frac{1}{2}$ in.; spokes, $1\frac{3}{8}$ by 1 1-16; felloes, $1\frac{3}{4}$ in.; length of front stock hoop, 2 in.; track of wheels alike on ground, 4 ft. 4 in.

Axles—Hind axles, length over collars, 3 ft. 9 in.; hind axles, length over flaps, 3 ft. 2 in.; front axles, length over collars, 3 ft. 9 in.; front axles, length over flaps, 3 ft. 2 in.; size of axle, $1\frac{1}{8}$ in.; Colling patent axles with solid flaps.

Springs—Hind elliptics, length centre to centre, 3 ft.; span over all, 8 in.; number of plates, 4; width of steel, $1\frac{3}{8}$ in.; thickness of main back plate, 5-16 in.; thickness of other plates $\frac{1}{4}$ in.; front elliptic springs, length, centre to centre, 2 ft. 10 in.; span over all, $7\frac{1}{2}$ in.; number of plates, 4; width of steel, $1\frac{3}{8}$ in.; thickness of main back plate, 5-16 in.; thickness of other plates, $\frac{1}{4}$ in.

Forecarriage—Depth of beds over all, 7 in.; compass of axle and transom bed, $2\frac{3}{4}$ in.; diameter of wheel plate, 1 ft. 8 in.; length from centre of wheel iron head to centre of shaft bolt hole in futchells, 1 ft. $6\frac{1}{2}$ in.; height of futchells from ground, 2 ft. 2 in.; undercarriage boxed on to body from front, 11 in.; hind carriage, centre of wheel from back to body, 1 ft. 1 in.

CONVERTIBLE VEHICLE.

Here is a convertible body for passengers, or by jumping the seats, a body for light freight or parcels. It is the invention of a German, Karl Kassdohrer.

The space under the platform is box shape. The movable parts of seats D^1 , D^2 are made with rests, which also fold against the seats. As may be seen in the drawing, a^1 a^2 are the sides and b

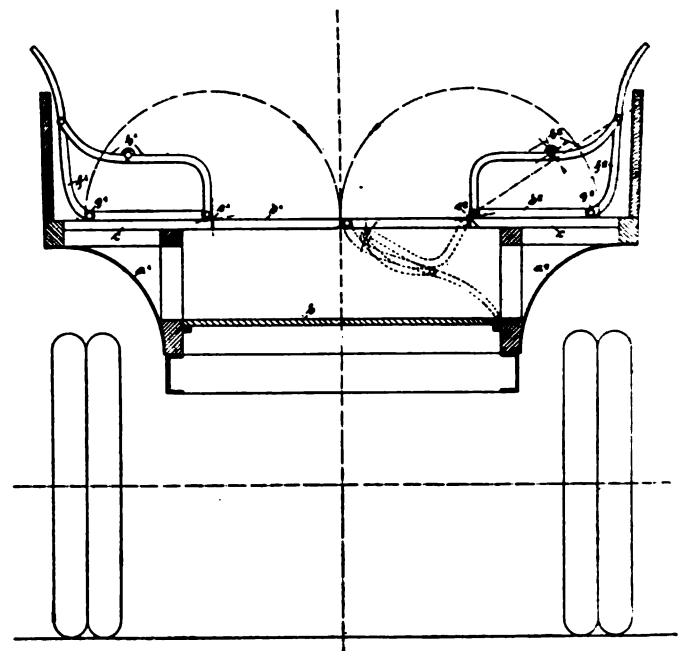

the bottom of the carriage body under the seat boards when turned down to make the van floor or bottom c . d^1 d^2 are the seat boards moving on the hinges e^1 e^2 , shown in the extended position and forming the seats. f^1 f^2 are the back rests to the seats. These rotate on the hinges g^1 g^2 on to the seats. In the folded down position (on the right in the diagram) they support d^1 d^2 from beneath. d^1 d^2 are connected by means of the jointed arms h^1 h^2 which have three hinged joints. They serve in the upright position (on the left in the diagram) as a support for the back rests and as arm rests.

Time is a great avenger, and brings good and evil to the broad daylight.

TRUCK FOR FISH.

What the Automobile and Carriage Builders' Journal calls a fish van is here illustrated and described from data found in that journal. There are some few interesting features that may be found of use by our wagon building readers.

The working details given herewith show a well designed fish van or for similar purposes which has been built by J. M. Egge-

mann, London, England. The drawings are to scale and of a fair size, so that any measurements may be easily ascertained by marking off on a piece of paper from the scale given and transferring it to the drawing.

Length, out to out, 8 ft. 1 in.; width, out to out, 49 in.; depth over all, 2 ft. 3 in. Main sides, 4½ in. by 2½ in.; two summers, 2¾ in. by 2 in.; front and hind eareadths, 3½ in. by 2 in.; front pillars, 3 in. by 3 in.; hind pillars, 2¼ in. at top, 5 in. at bottom. There are five iron standards each side, 1½ in. by ¼ in., passing through the top rave, through the center rave, and after passing through the bottom side are bolted there underneath. The side construction, together with the shape of the foot of the standard, is clearly shown in the side view of the driving seat.

A ½ in. center iron staff and the usual hind shorestaff is used, and the floating raves are firmly attached to the top raves, as shown in small sketch above the side elevation of the van here illustrated, and are also supported by ½ in. round stays bolted at the bottom end to the middle rave. There are three standards in front. The top board is double in front, and side name boards are used over the bottom side boards as shown. Raves, 1¾ in. by 1½ in.; top boards, 4½ in. wide; bottom ones, 9¼ in.; tail chains, 3 ft. 4 in. long; front carriage, 3 ft. 6½ in. long over splinter bar; guides and bars 2¾ in. by 1⅞ in.; hind springs, 40 in long, nine plates, 4½ in. compass; front springs, 36 in., seven plates; check spring, 3 ft. long, six plates, 4½ in. compass, 2¼ in. by ¼ in. steel, with 5-16 in. backs; hind scrolls, 6½ in. deep; front, 4 in. deep; bolsters, 4 in. by 4 in.; wheelplate, 2 ft. 6 in. diameter, 2 in. by ½ in.; wheels, 34 in. and 54 in., 2 in. by ¾ in. tires; dickey seat board, 24 in. by 14 in.; landing board, 2 ft. 1 in. by 10 in.; footboard, 25 in. by 23 in.; from top rave to under seat, 36½ in.; axles, arched back and front, 2 in.; spring centers, 42 in.; track over all, 5 ft. 3 in.; over flaps, 4 ft.; over collars, 4 ft. 6 in.; flap to collar, 2¼ in.; back of collar to plumb spoke, 4 in.; bottom of van to ground, 37½ in.

The van only weighs 17 cwt. with rugs and driving utensils. The front top rail is 2¾ in. deep, and strengthened with a 1½ in. corner plate. A 3-16 in. iron plate runs all round the top of the van, to take the wear of the boxes or crates of fish. The front corners of the van are rounded and substantial corner plates are fitted at the middle raves and bottom sides. The side nameboard

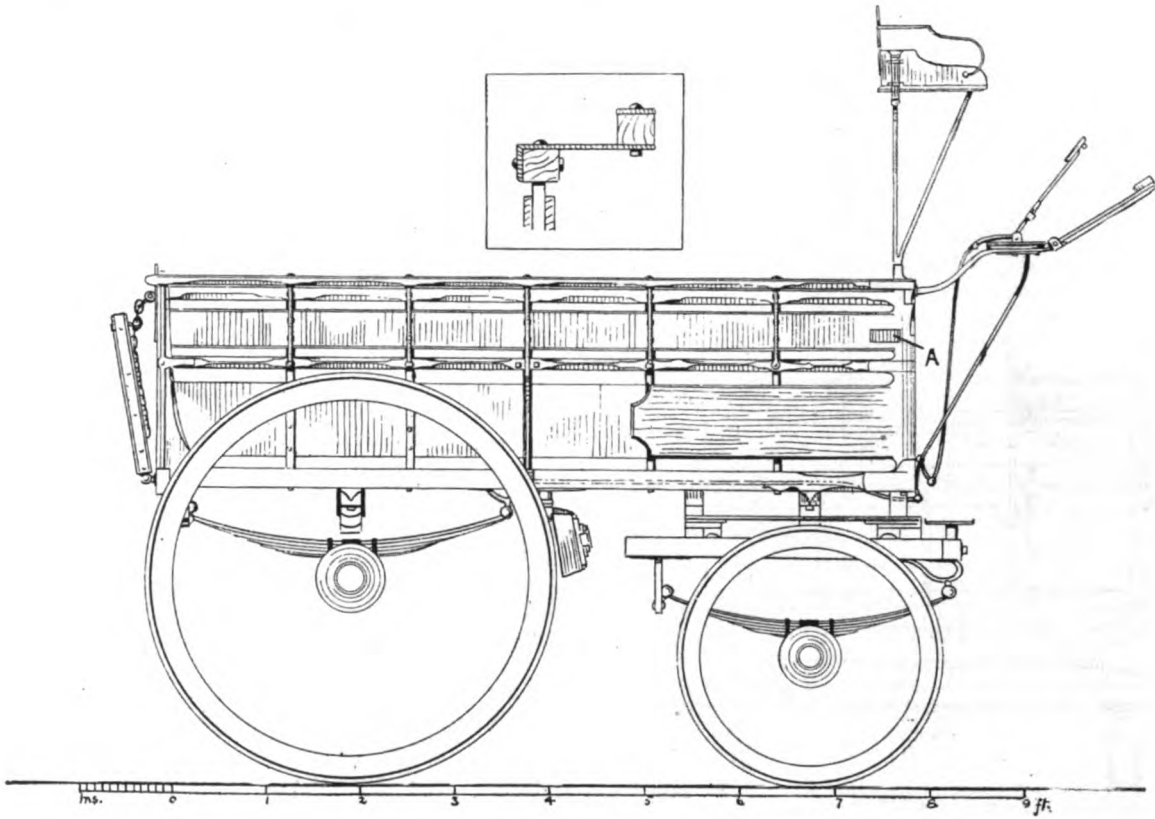

is 36 in. long. A flat lamp socket is screwed to the off-side front pillar, as shown at A on the side elevation.

The mounting of the dickey seat is clearly shown in the right-hand sketch. The stay is 1½ in. wide at the back and provided with a ⅞ in. bearing on the top front rail, while below it is bolt-

ed to the top bar, centre rave and bottom board, as shown in the left-hand sketch herewith. The footboard and brake treadle both fold inwards when required. The splinter bar is 3 ft. 5 in. overall, plated on front and bottom, and is provided with eyes for taking a pair of shafts. The rod J of the brake is flat-

is 36 in. long. A flat lamp socket is screwed to the off-side front pillar, as shown at A on the side elevation.

The mounting of the dickey seat is clearly shown in the right-hand sketch. The stay is 1½ in. wide at the back and provided with a ⅞ in. bearing on the top front rail, while below it is bolt-

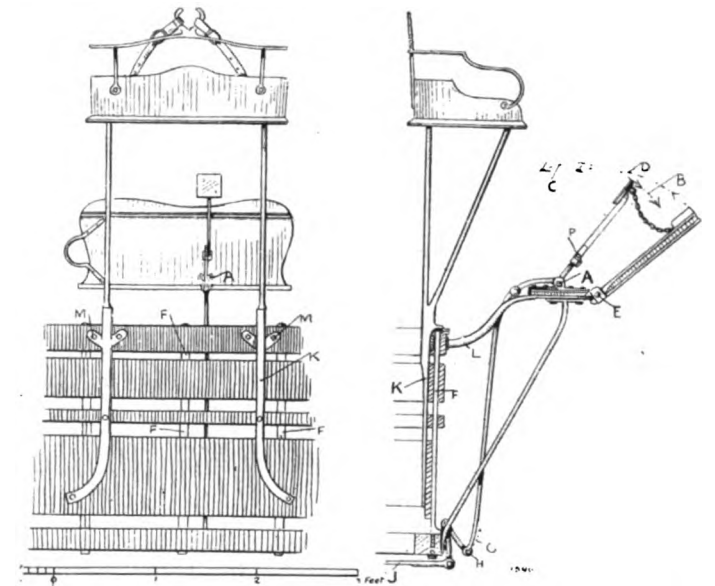

tened and curved upwards and is cranked horizontally so as to provide a central pull for the chains which are connected to each side striking lever of the brake pans.

The width inside the van at the bottom is $44\frac{1}{2}$ in.; at top, inside, 46 in.; and $57\frac{1}{4}$ in. over the floating rails. There are six half-round 1 in. plates $7\frac{1}{2}$ in apart on the bottom of the van, and the alternate floor boards are cut away $\frac{3}{4}$ in. to allow the water to escape. The tail board is $49\frac{1}{2}$ in by $21\frac{1}{2}$ in., and is plated on the inside to correspond with the floor, and outside has three

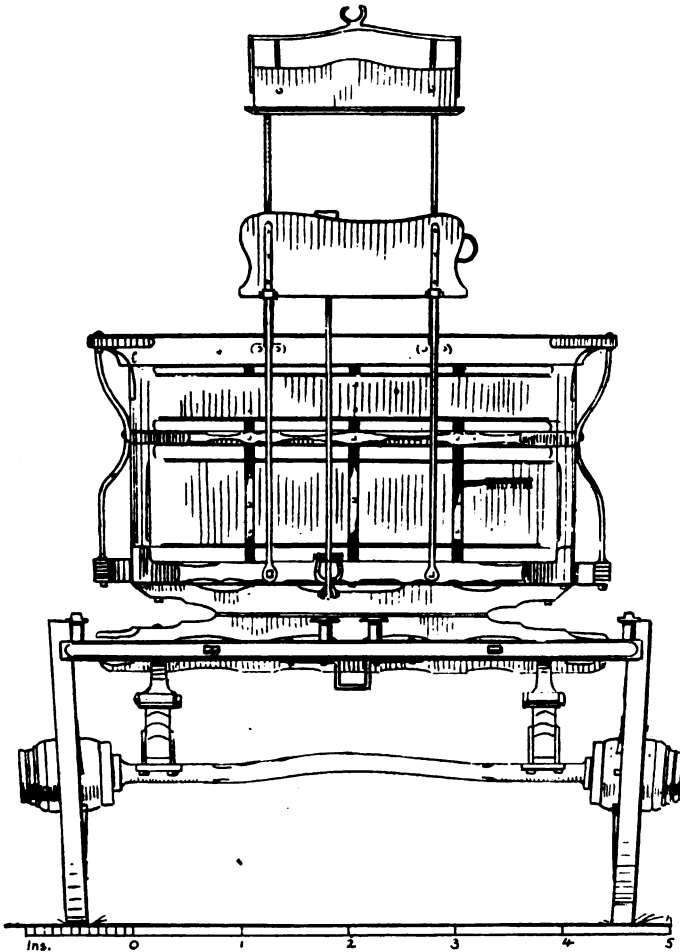

The Front View.

plates and is also strengthened by a plate running all around the edge. The front felloes are $2\frac{1}{2}$ in. and the hind 3 in., with twelve spokes in the front wheels and fourteen in the hind. The stocks are $8\frac{1}{2}$ in. and $9\frac{1}{2}$ in. respectively.

The van is painted blue with red lines, and has a red undercarriage, relieved with black lines. The dickey is red, also the footboard. A skid pan and wheel chain are provided.

BEATRIX GOODRICH.

There is no explanation necessary for a fellow who "rubbers" at any of the Goodrich girls. It makes us "tired" even to think of anyone with so little elasticity not to bend himself double to get a glimpse at these beauties of a family noted for the beauty of its products, not least among which are its lovely advertising beauties.

The lady noticed we have not really seen, only her counterfeit presentment by that fascinating portrait painter Beckwith; but for that matter who has seen any of these lovely girls in the flesh—and clothes, of course. Papa Goodrich is peculiar, he will let you rubber all the year, and help you do it—but just look at the picture, son! We congratulate the B. F. Goodrich Co., on its very, so-far, prettiest.

ADOPTS INSURANCE PLAN.

The Moline Wagon Company with the new year inaugurated an employees' insurance system similar to the one now in force in the shops of Deere & Co., of which the wagon plant is an auxiliary. Installation of the insurance system at the wagon plant, where it will benefit 300 employes, marks a continuation of the Deere scheme for an insurance and pension system in branch concerns, as well as in the main plant. The pension feature, now universal in the main Deere shops, is not included, however, in the plan which becomes effective in the wagon plant. The plan for the wagon company is a reflection of the one in the main Deere plants. There will be accident insurance as well as benefits in case of illness or death. The company will assume half the expense, while employes will make small monthly payments whenever accumulation of claims makes them necessary. Inauguration of an insurance system in the wagon plant means that the new year found three Moline factories operating with the modern feature. Deere & Co. blazed the trail by adopting the plan some time ago. Williams, White & Co. have adopted it within the year, and now comes the wagon company's announcement.

HICKORY SUPPLY IS SHORT.

At a meeting of vehicle manufacturers held at St. Louis, January 11, at the Southern hotel, a temporary organization was perfected, the purpose of which is to take some action to preserve the hickory supply of the country, which is said to be much depleted, due to wanton waste. B. T. Von Behren, of Evansville Ind., was made chairman of the meeting. Resolutions will be drawn and presented to Congress asking that immediate action be taken to preserve the remaining hickory timber of the country.

It was said at the meeting that hickory timber will be almost unobtainable in fifteen years at the present rate of consumption. The prices of carriages, wagons and other vehicles whose parts are manufactured largely from hickory are worth from 10 to 25 per cent more this year than last.

NEW WAGON COMPANY.

The American Wagon Co., Chicago, Ill., a new organization, has taken over the business of the Grand Detour Wagon Co., Dixon, Ill. The purpose of the new company is to manufacture a convertible wagon box, which can be changed from an ordinary wagon bed to hay rack, stock rack, or a rack for other purposes. The company is composed mainly of Chicago people. The president is E. B. Overshiner, who is also president and treasurer of the Swedish-American Telephone Co., Chicago and Kansas City. The secretary is Stewart Spalding, manager of the Coliseum, Chicago. Among the directors are: H. N. Taylor, L. A. Nies, H. H. Windsor, president Popular Mechanics Co., and John Ringling, the circus man.

INCREASING GUAYULE RUBBER SHIPMENTS FROM MEXICO.

Consul Wilbert L. Bonney reports that the declared exports of Mexican products via San Luis Potosi to the United States amounted to \$4,395,384 in 1910, an increase of 29 per cent over 1909. The largest increase was in guayule rubber, being \$1,224,222 for 1910, against \$249,239 for 1909. This article appeared in the exports of that district for the first time in 1901, but did not rise to importance until 1908.

ATHLETIC VEHICLE MEN.

The first athletic entertainment in the gymnasium of the Vehicle Workers' Club Flint, Mich., was held on January 16. The program included wrestling matches, boxing contests, and exhibitions on the horizontal bar. A similar entertainment will be given each month.

Carriage and Automobile Painting

ALL ABOUT GLUE.

A large importer of glue stock is thus quoted: It is a tribute to the ability of the American glue manufacturer, that with a comparatively moderate protection, he is able to use to advantage glue stock, imported from nearly all parts of the world. There are few countries which do not contribute something to his kettles, and few domestic animals which do not yield their share.

At the time of writing the market for foreign glue stock is about at the bottom; the price for it in the American market being a little more than enough to compensate for the cost of collection, packing and transportation. There is a fair supply of moderate demand. For a high class stock there is a better demand and supplies hardly meet requirements. The general closing of the heavy leather tanneries recently announced is likely to be felt in the market, as it means a cessation of the domestic supply for some weeks, and this too in the height of the glue making season.

Tools for Glue Handling.

In the first line come the tools of precision: thermometers, scales and weights. Gauging glue heat and jelly temperature requires a quick working, accurate instrument especially constructed for that kind of work. The late Wm. H. Weinlagen, after considerable experimenting finally constructed what was wanted and the problem was solved. These thermometers have been of great help to glue men, no doubt about that. The Holman type of thermometers and the Tagliabue construction is "the" combination. A unique feature is the interchangeable thermometer. Place a detachable thermometer socket wherever you may want to gauge the heat—any number of them—and the Interchangeable Thermometer can be inserted in any one of these sockets and you get a temperature reading on the spot from a standard and true instrument and the same instrument in each case. A unique as well as a useful feature.

The Troemner scales are used in the United States mint, etc. The capacity of these bullion scales is 10,000 ounces in each pan and with full load the scale is sensible to 1-100 of an ounce or one part in one million parts.

Heat Damage to Glue.

The moment a mixture of glue and water is heated enough to melt it a gradual change begins to take place in such a way that the water taking or spreading capacity of the glue is gradually destroyed; the "body" is so to say boiled out. It is caused by the water attacking the glue and heat increases the effect of the attack.

The damage is in direct proportion to the amount of heat and to the length of time the glue is kept under the influence of heat.

When kept warm all glues are thus gradually killed; there are absolutely no exceptions. The damaging action begins at once.

While the glue gets thinner in body and poorer in quality—water is at the same time evaporating and this continual evaporation conceals from you the fact that the glue gets thinner. That is why it always escapes observation. A single experiment will prove the facts.

Suppose your man prepares fresh glue—taking 38 parts of glue and 62 parts of water to make 100 parts of liquid glue by weight. This glue will then be kept warm and used during the day. Some water evaporates and perhaps some little is added to thin it out again.

If you now examine the glue at the end of the day, you will find the body-thickness or consistency of it is the same as in the

morning. There may be less glue, but of course some has been used, and there seems really to be no reason for suspecting anything.

But this liquid has undergone a change—a very important change. While the visible consistency of the glue is as before, the real make-up of the glue is different; the glue contains now about 46 parts of glue and 54 parts of water in every 100 parts of liquid glue.

The influence of the continued heating shows itself therein that although the liquid now contains over 20 per cent more dry glue, it is not any thicker than when it was fresh prepared—and then there was only 38 parts of glue in every 100.

That is a clear loss of 8 parts of glue for every 38 parts—that means a useless expenditure for glue of between 20 to 25 per cent.

These are conservative figures. Sometimes a glue is kept warm for several days in a steam-jacketed kettle, heated by steam under pressure of 70 to 80 lbs.—and then the damage is much higher.

You see also why this escapes observation—because the glue as it is found in the pot after it has been prepared has never been tested.—Glue Monthly.

EMPTYING VARNISH CANS.

The correct and incorrect way of emptying the contents of a can is here illustrated.

If can is held as shown in A illustration it will drain perfectly

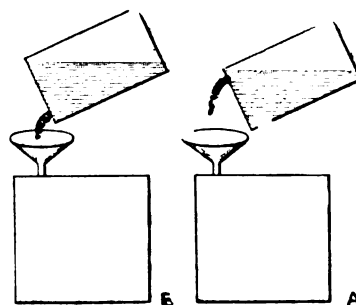

to the last drop without waste. This is due to the air having a chance to enter container over the contents, filling the void made by the decreasing level of the fluid. The B illustration is just the most wasteful, hence the wrong way to do the work.

THE AUTOMOBILE ENGINEER LEARNS ABOUT THE "DEVILTRIES" OF VARNISH.

We copy from The Automobile an account of the tribulations of the autocar engineer, who knows it all, according to the authority quoted:

One of the makers of automobiles, during the dull season, had to store some 150 automobiles for several months. These cars were put in shape for shipping, and as the company thought, all that remained was to hunt up customers, which it proceeded to do. When things picked up again it was found that over half of the finished cars were unacceptable to the agents on account of the state of the body finish; the storage room was dusty and the finish of the body work was soft when the cars were placed on storage.

The cost of the refinishing was not far from \$50 per car, not counting the delay. The work of refinishing was done as follows:

The bodies were removed from the automobiles and were

placed in a light, well-ventilated room, protected from dust. The chasses were rolled into a separate light, well-ventilated room, protected from dust, and carefully gone over. The bodies were rested on "horses" and gone over to get rid of the free coat of dust.

With small bunches of waste saturated with turpentine the body surfaces were rubbed down to soften the outer skin of varnish. Strips of burlap were then used, rubbing vigorously to remove the accumulation. By scraping, using a knife or a hook, accumulations that resisted the burlap rub-down were taken off. A second application of turpentine on waste was given to clean off all the remaining particles and any grease that might have been picked up. A burlap rub-down followed. In one or two bad cases, where the accumulations resisted removal, soft soap, with a dash of sal-soda was applied, using a coarse hair rubbing pad in the process.

The next rub-down was with pumice stone flour to remove all the specks. This process also flattened down the surface.

In all the cases that looked promising enough to "finish" with one coat of varnish, the old color was matched up, using enough rubbing varnish in the new match to cause it, when applied to the surface, to dry with enough gloss to counteract the light-absorbing qualities of the color. Judgment had to be used, especially in bodies that showed "dead," and it was not possible to top off with one application of varnish.

PAINTING METAL PARTS OF AUTOMOBILES.

Paint is applied to the metal parts of the automobile in layers that are worked into one another, each coat being allowed to dry before the next is applied, the whole forming a homogeneous mass that is liable to damage, and should some sharp instrument strike it the paint will chip off, leaving the metal bare. Rust creeps in and rots a good deal of the paint around the original bruise. Whenever an adjustment or repair is to be made to the engine the mudguards can be protected by laying cloth over them, as shown in the illustration. If a blow has to be struck on bolts that have been painted, some soft material, such as leather or a rag, should be interposed to protect the paint. The paintwork on the car is subjected to sufficient bad treatment in washing, and in order to retain a good appearance it is necessary to resort to these little helps.

STRICKEN AS HE RESPONDS TO TOAST.

Samuel Greene, a wagon manufacturer of Florida, N. Y., while speaking at a banquet at Middletown, N. Y., startled his hearers by saying: "Gentlemen, I cannot proceed further." He dropped into a chair. He had suffered a stroke of paralysis on the right side, which rendered him speechless and unconscious. He is now in a hospital. Mr. Green is seventy years old, a prominent Free Mason, and is affiliated with Mecca Temple, New York.

COMBINED MEETING.

The Omaha Implement and Vehicle Club combined its monthly and annual meeting into one January 10 at the Rome (Neb.) hotel, making it an occasion for a banquet and the presentation of two fine presents.

E. A. Hatfield, the retiring president of the club, was made the recipient of a fine gold watch. C. C. Troxell, of the Moline Plow Company, who retires soon from active business life, having been on the firing line in Nebraska for thirty years, was given a remembrance by his associates in the implement business in the form of a large Morris chair with its accompanying footstool and library stand.

The officers elected for the coming year were as follows:

N. R. Lunery, president; F. R. Davis, first vice-president; R. L. Robinson, second vice president, M. H. Gibbs, treasurer, V. N. Squire, secretary; executive committee, B. L. Rees, chairman; H. F. Norman, H. J. Bailey, J. M. Hogg and H. E. Daniels.

ARMLEDER ON VEHICLES.

Otto Armleder, president of the O. Armleder Company says: "During 1909 the carriage industry throughout the country was greatly disturbed by the popularity of the automobile. While the automobile has made serious inroads upon builders of high class carriages it has not had that effect upon builders of medium grade work.

"Many of the high-class carriage builders have gone out of business since the automobile came into use or have changed their business over to making bodies, trimming and painting for the auto manufacturers.

"In Cincinnati the carriage builders make a medium grade buggy, and this line has been stimulated by an equal consumption, compared with former years, and as many of the large manufacturers changed their business to making automobiles it has greatly benefited the ones who remain in the carriage business.

"The result has been that during the year 1910 all manufacturers gained in their output. Their trade has therefore been considerably better than any year since the high tide in 1907. All of the manufacturers report to-day as having more orders on their books for 1911 business than they ever had at this time before, and this is the beginning of the season. The indications are that they will have a considerable increase over 1910, and therefore feel jubilant over the prospects for 1911."

FOURTH CONVENTION.

The fourth annual convention of the Oklahoma Blacksmiths, Horseshoers and Wagonmakers' association opened in Oklahoma City, January 16. When the opening session was called to order 175 members were present. Reports of the standing committees on finance, membership and the like were heard, after which the work of the special committees was taken up. The committee on prices was ordered to prepare a schedule of suggestive prices, which, if adopted, will make uniform prices on all work done by the members of the association.

No report was made by the legislative committee. Several members of the legislature were present at the night session, and assured the blacksmiths that they would support legislation designed to protect the members of the body. A law giving them a lien on work done on carriages, horses and the like is wanted. The legislative committee is composed of C. F. Dayton, of Chickasha, T. E. Dowell, of El Reno, A. E. Nichols, of Morrison, and J. A. Merlin and C. W. Rathbun, of Oklahoma City.

TAKES IN EVERYTHING.

The Dallas Implement, Machinery and Vehicle Club held its January meeting in the Oriental Hotel. Under the head of miscellaneous business a matter was brought before the meeting in which all members of the club were much interested—that of the membership being well represented at the conventions to be held in Houston, February 14, 15 and 16, by the Texas Hardware Jobbers' Association, the Retail Dealers' Hardware and Implement Association of Texas and the Southwestern Retail Saddle and Harness Manufacturers' Association. The executive officers of these three organizations considered it wise, because of the close commercial relations existing between the lines of hardware, implements, vehicles, saddlery and harness, to hold all three conventions at the same place and on the same dates.

IT WAS A WALKOUT "DEAL."

About a dozen men employed in the wood shop at the Deal buggy factory, Jonesville, Mich., quit work and walked out recently. The men were given thirty minutes by the superintendent in which to return to their work, but none of them took advantage of the opportunity. Dissatisfaction with the methods and management of the woodshop is said to be the reason for the walk-out.

TECHNICAL SCHOOL ALUMNI DINNER.

The Alumni Association of the Technical School for Carriage Draftsmen and Mechanics held its annual meeting and dinner on the evenings of January 10 and 12, respectively, at Hotel St. Denis, Broadway and 11th street, New York City, during the week of the Madison Square Garden Automobile Show, when many of the graduates were in town in the interests of the various concerns they represent.

The usual matters pertaining to the welfare of the association were conducted during the business meeting. A regrettable feature of this meeting was the announcement by Professor Johnson, of the death of one of the recent graduates of the school, Edward Everett, of Buffalo, N. Y.

At the dinner the tables were profusely decorated with carnations and each course of the menu was well taken care of. President Frederick J. Kubler was admirably fitted as toastmaster. Although no set speeches were made, many impromptu talks were indulged in on subjects of vital interest to all present.

Among those at the dinner were: Prof. A. F. Johnson; F. J. Kubler, W. W. Heite, G. H. Woodfield, Alex. Holmes, G. V. Rasmussen, Ralph Leslie, Peter Garvin, Joseph Klein, G. W. Quinby, John Wilke, W. T. Bennett, Carl Hamann, Joseph E. Straub, Fred Hengel, J. H. Klein.

The officers elected for the ensuing year were: President George V. Rasmussen; vice-president, George H. Woodfield; secretary-treasurer, Jacob H. Klein; historian, Carl Hamann.

ORGANIZATION CHANGES NAME.

The annual convention of the Southern Illinois and Missouri Retail Implement and Vehicle Dealers' Association opened at the Southern Hotel, St. Louis, on January 25. President N. C. Mangold, of Anna, Ill., presided. About 150 delegates and members were in attendance.

Express rates and cost of manufacturing plows and other implements from the raw steel product were taken up. Resolutions were drawn protesting against the proposed increase in freight rates and the present express rates, which the association declared to be entirely too high.

The association is desirous of having express companies placed on the basis of common carriers, so as to be under the jurisdiction of the state railroad and warehouse commissioners.

A good deal of time was taken up with a discussion of the proposed change in the name of the organization. It finally was decided to change the name to Mississippi Valley Retail Implement and Vehicle Dealers' Association. This action will be taken so as to admit Arkansas, West Tennessee and Kentucky to the association. By this move the membership will be increased to 500 persons, it is hoped. The association will meet in St. Louis next year, unless a change is made in the by-laws.

President—Edward G. Busch, Washington, Mo.

Vice-President—J. M. Munro, Cuba, Mo.

Secretary—Robert Seibert, Belleville, Ill.

Treasurer—Matt Sproul, Sparta, Ill.

Director for three years—W. C. Mangold, Anna, Ill.

CHANGED NAME.

The corporate name of the Anderson Carriage Co., has been changed to the Anderson Electric Car Co. The Anderson Carriage Co. was at one time located in Port Huron, but removed to Detroit in 1895. Practically the same board of directors and officials are still in charge of the company's affairs. W. C. Anderson has acted as president and general manager since its organization in Port Huron in 1888. W. M. Locke is still treasurer and has successfully handled the finances of the company during the many years of his incumbency. The board of directors has been increased to nine members. The additional directorate includes C. M. Bacon, G. D. Fairgrieve and W. B. McFarland, of Detroit, and F. E. Price, of Chicago.

VEHICLE MANUFACTURERS OF NEW YORK CITY HOLD ANNUAL BEEFSTEAK DINNER.

A large representation of carriage and wagon builders of New York City and Brooklyn assembled on Saturday evening, January 21, at Vienna Hall, 58th street and Lexington avenue New York, to do justice to the fourth annual beefsteak dinner of the Vehicle Manufacturers' Association of New York City, as carefully arranged by the committee in charge of the affair; consisting of the following well known members of the vehicle trade: O. J. Duhamel, chairman; Wm. H. Hoepfner, treasurer; Thos. J. Clark, George MacBeth, Joseph Huber, Jr.

The assemblage was augmented by the presence of representatives of several supply houses and the trade press, who were the guests of the association.

Upon entering the hall the members and guests were supplied with large white aprons, which they immediately donned, but which, to the amusement of the onlookers, would hardly girdle some of the most prosperous participants of the event. Round tables were placed about the hall, at which all were seated, and it was obvious that all thoroughly enjoyed the juicy pieces of beefsteak, celery, etc., placed before them, as well as the refreshments which were necessarily included.

The talent, especially engaged for the occasion, furnished endless amusement and kept the wagon builders in ecstasies of laughter until the close of the affair.

About one hundred gentlemen were present at the gathering including some of the largest vehicle manufacturers of Greater New York. The cares of business were shelved for the evening and the unanimous trend of thought was "to have a good time," which no doubt they succeeded in accomplishing, both individually and collectively.

The officers of the association consist of the following prominent vehicle builders:

President—H. J. Huemmer.

Vice-President—Chas. W. Diehl.

Treasurer—Jacob Mattern.

Recording Secretary—Frederick Heins.

Financial Secretary—Wm. H. Hoepfner.

Sergeant-at-Arms—Joseph Huber, Jr.

Executive Committee—Thos. J. Clark, chairman; Chas. Bartsch, Geo. MacBeth, O. J. Duhamel, H. D. Schumacher.

ENLARGE WHEEL WORKS.

A short time ago the Mott Wheel Works, Utica, N. Y., increased its capital stock from \$50,000 to \$150,000. It is understood that Frederick Gilbert and Charles B. Rogers, two of a number of new stockholders, will be placed on the board of directors, which at present consists of Henry R. Williams, Clarence B. Williams and O. W. Mott. The company is planning to extend its plant by taking in an additional building somewhere in the immediate vicinity.

WANT BOB SLEDS STANDARD TREAD.

The Wisconsin autocar owners are interested in a movement that may reach the legislature for a law which will require that bobsleds be given a 56.4 inch tread, the same as wagons. At present sleds have but 50 inch width and it is claimed that if they were uniform and in conformity to wagons the roads would be protected and it would be possible to use motor cars all winter. A new law may be asked on the subject.

MICHIGAN DEALERS ORGANIZE.

The Implement and Vehicle Dealers of Kalamazoo County met at the Commercial Club, Kalamazoo, Mich., on January 12 and perfected plans for an organization. Another meeting will be held at the latter part of March at which officers will be elected and the association formally launched.

ANNUAL MEETINGS AND ELECTIONS.

Annual meeting of Keystone Vehicle Company, Reading, Pa., was held January 18. Following are the officers chosen: President, Edward C. Nolan; treasurer, W. L. Davis; secretary and general manager, John L. Coxe; assistant manager, H. B. Burmeister. The directors are: Robert E. Brooke, George Brooke, Jr., Edward C. Nolan, J. Bennett Nolan, Warren L. Davis, G. Stanley Hendel, John L. Coxe, and H. B. Burmeister.

The first annual meeting of the Edgerton (Wis.) Wagon Company was held January 10. The report of the directors was a lengthy one, covering the arduous duties of securing a site down to the getting of the plant into active operation. The report also urged the selling of at least \$10,000 more of stock to provide a more efficient working capital. The consolidation of the New Stratman Vehicle Company, acquired recently, was endorsed as a most valuable acquisition to the local institution. Three directors were elected for three years—B. C. Willson and P. M. Ellingson to succeed themselves, and W. W. Huxtable, the new manager, in place of W. B. Wentworth. At the close of the meeting a large amount of stock was sold.

At the annual meeting of the Lansing (Mich.) Wagon Works Company, January 5, the board of directors was re-elected for the coming year as follows: F. Thoman, E. F. Cooley, R. M. Montgomery, of Washington, D. C., E. A. Barnes, of Detroit, and A. A. Nichols. Mr. Thoman was made president, Mr. Cooley vice-president, and Mr. Nichols was re-elected secretary-treasurer. Frank W. Hammond was again made assistant secretary and general manager.

The annual business meeting of the stockholders of the Troy (Ohio) Wagon Works Company was held January 9. All of the old officers who served during the past year were re-elected, as follows: George R. McConnel, president; Frank M. Chase, vice-president; C. T. Brown, secretary-treasurer; G. A. Geiger, general manager; A. R. Garver, Charles N. Peters and H. E. Sheets, directors.

The Franklin Buggy Company, Barnesville, Ga., held its annual meeting January 3, and, according to reports of officers, its business for the past year was very satisfactory. Although a new company, it made and sold during 1910 800 buggies, which were shipped throughout Georgia. The prospects for the future are promising. The following officers were elected for another year: Dr. R. A. Franklin, president; Ben. Franklin, vice-president; A. H. Franklin, general manager; T. J. Franklin, secretary and treasurer. They are all brothers and own and control the affairs of the company.

The Springfield (Mo.) Wagon Company at a recent meeting of the directors, held the annual election of officers, who will serve for a year. They are: H. F. Fellows, president; Peter McCourt, of Denver, Colo., vice-president, and F. J. Curran, secretary and treasurer. The directors for the next year will be the three officers and Mrs. McCourt and Keet Curran, son of the secretary and treasurer. The regular dividends of the company were declared and business prospects discussed. According to one of the officials the past year's business was one of the largest in the history of the company and prospects for the coming year are very bright.

At a meeting December 27 held by the stockholders of the Heaton Wagon Factory, Fort Worth, Texas, the following were elected directors of the company: I. H. Burney, Paul Waples, Ben. J. Tillar, Warren Heaton, C. W. Hughtower, Willard Burton and W. C. Stripling. One of the men will be selected to go to Neosho, Mo., to expedite the forwarding of the plant to Fort Worth.

"THERE IS NOTHING NEW UNDER THE SUN."

Solomon seems to be an authority in good quotable standing even unto this day. We point with pride to the fruits of our ingenuity in matters of all kinds. We have graced the patent office with neat drawings and interesting specifications of our inventive thought on the subject of "artillery" wheels, detachable rims, and inflated tires, but here we present a print that has come from some museum, probably, showing that in the pleasant summer days in the B. C. period, the Egyptian gentlemen of wealth, probably an ex-president of the Pyramid Trust, was taking his



interesting family for a spin along the Nile speedway, in a fine equipage, built by the leading builder of the capital, the wheels of which were the true artillery pattern, the rim of the detachable variety, and the tire looks as if it was of the real inflated variety.

We have just seen the ending of one "celebrated case" of the patent kind, now why not another with the exhibit of "common knowledge" as the strong document to bring inventive ingenuity to naught. Probably there are legal gentlemen of great learning in the law who would take the case on "a contingent fee," provided they could get a whack at the costs.

"UNION" NEWS.

L. F. Maire, of New York, president of the Carriage, Wagon and Automobile Workers' International Union of North America, and William P. Mavell, of Buffalo, secretary and treasurer, attended the meeting of the local union in Labor Temple, Utica, N. Y., and made speeches on the advantages of organized labor and the advisability of securing an eight-hour day for members of the union. President Maire stated: "It is not our intention to try to knife any manufacturer or to create any bad feeling between employer or employee. The relations existing between the carriage manufacturers and the members of the union are amicable and it is not my intention to create any disturbance."

The Carriage and Wagon Workers' International Union, No. 151, met January 4 in Newark, N. J., at which time officers for the year were elected. John Guth was elected a member of the executive board. Howard Menig was appointed a delegate to the Union County Trades Council. The establishments of A. C. Pool, Herman Schick, Louis Koplán and Fischer & Dackermann, of Newark, were represented at the meeting.

The carriage and wagon workers' local union at Memphis, Tenn., elected and installed the following officers for the ensuing term: H. R. Cooper, president; Lee Barrett, vice-president; Ollie Watkins, financial secretary; August Neff, sergeant-at-arms; Wm. J. Nettles and Joe Haggerty, delegates to Trades Council; Ollie Watkins, business agent.

RUBBER TREES EVERYWHERE.

There are about 700,000 rubber trees growing on the island of Trinidad, which number will be greatly increased in the next few years.

LIGHTING FACTORIES.

The factory lighted electrically has a choice of the incandescent arc and mercury vapor lamp; sometimes a combination of the three.

The mercury vapor lamp consists of a long glass tube about an inch in diameter, with a bulb at one end containing a small quantity of mercury and provided at both ends with electric connections sealed in. The tube is suspended at a slight angle from the horizontal and when in operation gives off a peculiar light of considerable power.

The chief advantage of this lamp is that it gives a very uniformly distributed light, but it has a counterbalancing disadvantage in the peculiar quality of the light which is of a greenish tinge owing to absence of red rays. Faces seen in this light have a particularly ghastly appearance, and it is not at all cheerful, but the light is very steady and is said to be easy on the eyes, so that for machine shops, when supplemented by a certain amount of individual lighting, it is rather highly spoken of.

The chief difficulty in regard to the candle power of arc lamps is in the varying intensity of the light at different angles, for measured at an angle of 15 to 20 degrees from the horizontal it may be as much as 4,000, while if taken vertically underneath it may not be a quarter of this.

NEW EASTERN REPRESENTATIVES.

The Emerson Carriage Company, of Rockford, Ill., has recently added two new travelers to its force. Mr. M. H. Pleis will represent the company in eastern Pennsylvania, New Jersey, and a portion of southern New York. He was formerly with the Anderson Carriage Manufacturing Co., Anderson, Ind., representing them in the territory named. Mr. Oscar Becker, formerly eastern traveler for the Fuller Buggy Company, and later with the Jackson Carriage & Sleigh Company, will cover northern and eastern New York and the New England states. The company now has a force of eighteen direct travelers, outside of its regular branch house and jobbing connections.

Secretary Jackson says the company's specified business to January 1 exceeded its entire volume for 1910, and that he is very optimistic as to the future of the carriage industry.

RICKSHAWS WANTED.

An American consular officer has received a letter from a business man in India asking to be put in touch with carriage manufacturers in the United States who could build for him a large number of rickshaws on drawings and specifications furnished. Firms desiring to undertake the contract should address the Bureau of Manufactures, referring to No. 6174.

CARRIAGE MANUFACTURERS BANQUET.

The carriage manufacturers association of Boston and vicinity held its ninth annual dinner at the Revere House on the evening of January 31, more than 150 members and guests attending. President Robert E. Harrison was toastmaster. The dinner was followed by an entertainment. The affair was in charge of a committee consisting of M. W. Quinlan, Jr., John W. Campbell, Albert A. Sargent, James S. Waddell and John A. Kiley.

ELECT THEIR OFFICERS.

The Western Retail Implement and Vehicle Dealers' Association closed its twenty-second annual convention in Kansas City with the election of officers: President, C. T. Cochran, of Plainsville, Kas.; vice-president, Harry Meade, Vinita, Okla.; secretary, H. J. Hodge, of Abilene, Kas.; directors, W. T. Osborn, Gallatin, Mo.; J. M. Taylor, Columbia, Mo.; G. W. Collins, Belleville, Kas.; P. Westmacott, Hutchinson, Kas.

CATALOGUES.

"Making the Mitchell Car" is a booklet well and plentifully illustrated. It is an invitation, in a way, to the home of the Mitchell-Lewis Motor Co., when the guest is shown through the house. It is a fine house.

The High Point Buggy Co. take advantage of its home country to show the mountain peaks, and in the clouds above them is "Away up in Quality." This is the emblematic cover to a catalogue that reflects much credit on our North Carolina friends, just as the work turned out in style and quality reflects credit on that enterprising concern.

The Emerson "Ideal" top attachment, made by the Emerson Carriage Co., in Cincinnati. The idea of the Ideal is inside joints. They are, naturally, more accessible than outside, and should attract by the force of their convenience. Found only in Emerson vehicles.

McIntyre commercial motors are the kind of "good" that make good in daily work. This is a superior good to theory, paint, or prettiness. The W. W. McIntyre Co. have been at Auburn, Ind., long enough as builders of buggies, and as pioneers in high-wheel work, and successes in every other kind of work, to make written encomium unnecessary.

"The Studebaker," the once-in-a-while issue printed by the Studebakers at South Bend, Ind., maintains its early promise of excellence in the initial 1911 number. The only false, yes, even confusing step, we notice is this, addressed to dealers. "Tell us what you want in the succeeding issue and we'll give it to you." We hardly think the Hon. Charles Arthur Carlisle will stand for that, if the dealers really tell him what they want. But it's a nice little publication.

The Kratzer Carriage Co., of Des Moines, Iowa, certainly has taste in catalogues as well as in vehicles. The No. 21 just issued is a beauty. The illustrations of the work make it look good enough to eat. We notice a canopy top surrey named Peerless, that has very pleasing lines, another, the Cleopatra, is nice enough for that famed lady to loll back in, and so it goes through the pages. The Kratzer people are the right kind.

BIG WAGON PLANT FOR BIRMINGHAM.

A large, modern factory for building fancy wagons of all kinds will be constructed in Birmingham, Ala., this spring. Work will commence about the first of March. The plant will be constructed on Avenue E and Eighteenth street, where railroad frontage is available, and will occupy a lot 70x150 feet. The factory will be a four-story concrete building after the most modern construction plans and absolutely fireproof. Between 100 and 150 skilled workmen will be employed and the plant will represent an investment of between \$75,000 and \$100,000. It will include a down-draft blacksmith shop with 10 fires, a modern paint department where the finest class of work can be produced, and the other departments necessary to the construction of fancy delivery wagons of all kinds. It is expected that the plant will be completed in June or July, and will commence operations at once. It will be built by P. B. and S. H. Matthews, of the Birmingham Buggy Company, who expect to sell their present plant.

NEW WHEEL PLANT BOOMING.

The Hollingsworth Wheel Co. is the latest industry added to Hagerstown, Pa. It has a force of thirty men at work. Work is being cut out for rims and hubs and in a short time the plant will be producing the finished products. Another carload of machinery will be installed as soon as it arrives. The plant has a very promising future.

MAKING UP CARRIAGE CUSHIONS.

Lay off the bottom in blocks, but in doing this, consider the flares of the seat, so as to have the side and back blocks somewhere near the size of the middle ones. When this is done and the facings shaped out, lay them to the bottom and draw the bottom line across. When the bottom is sewed to the facing these lines must come together. You must cut your facings a little smaller than the bottom, also cut the bottom a little larger than the seat board. This will prevent drawing the bottom when sewing the facing.

Next make a frame out of $\frac{5}{8}$ in. thick poplar or ash, $1\frac{1}{2}$ in. wide, and have the frame a little larger than the cushion top. Draw unbleached muslin over the frame and paste another piece over this. When dry, draw a red line for the front part of the cushion, lay the bottom within $\frac{1}{4}$ in. of the line. Mark at each tuft line, and whatever the flare is, allow $\frac{3}{8}$ in. on the sides and back. When this is done, take the bottom off and draw the tuft lines on the frame. Take small bench awl and pierce through the tuft marks, and draw across over the hole on the other side. This will show where the tufts are to go.

Next lay off the cloth. There are several ways of doing this, but we will speak of two only. Lay cloth on bench with nap towards you, give each block $\frac{5}{8}$ in. fulness lengthwise and $\frac{1}{2}$ in. cross-wise. Allow plenty of cloth around the edges, say $1\frac{1}{4}$ in.; punch a small hole for the tuft and crease with a hot iron on the wrong side, along the chalk lines. If the cloth is heavy, it will not require any lining, but paste a small muslin stay under the tuft. Place a layer of thick batting over the cloth, put a little paste at each tuft, but none of the edges.

Next lay hair on the frame, a thin layer at a time, and do not press it, but let it lay loose and about four to five inches high. Lay the cloth over this and fasten with needle and thread at each tuft line. When this is done, take cushion needle and thread and tuft the cloth down, making each one single, and draw down close to the muslin frame. Next take the small round awl or tufting needle and work the blocks in shape. It is not necessary to be particular with this part, nor have it stuffed too full, but do this when the bottom is stuffed.

Sew down the edges with a back stitch and draw the cloth light—that is, do not have too much fulness at the top, after it has been sewed to the facing, will look very bad around the edges. Sew close to the lines on the frame, and wherever there is a bad place push a little hair under it. Paste the muslin over the cord, and when dry trim off to suit $1\frac{1}{8}$ in. over, basting the cord to bottom of facing, and the fall to this, and then sew the bottom on.

Now turn and beat the corners out, also along the front. Turn it again and baste cord to top of facing. Be particular to have the nap of cord cover to run the same as the cloth on the front. Cut the top from frame, allowing $\frac{1}{4}$ in., and sew it with thread to the tuft line at the corners. If there is too much fulness at the corners, this fulness must be worked out. Leave the mouth open from the corner tuft line at the back, turn the cushion and cord at the corners with cotton; then sew the mouth up to within 12 inches.

Stuff the bottom up firm, being careful to keep the stuffing to the front, and when you think the bottom is well filled, feel along and work it toward the front. When this is done right, tack the mouth to the cord with thread at the tuft lines, and draw the tufts in the regular way, commencing with the front row, and then sew the mouth up. Leaving the mouth open until the tufts are in, keeps the strain from the cloth, and you have a chance to fill in more hair if necessary.

We will give another way of making up cushion tops. Work the bottom facings and cord the same way as explained above, and the frame also, as the difference is only in laying off the cloth and spread it out on the bench with the face side up and the nap toward you. The bottom is now laid off for the tufts. Lay this in the cloth, with one of the lines on the crease of the cloth, allowing one inch fulness on the front.

Take French chalk and mark at each line from the bottom. Allow the same fulness around the edges as in the former method. Take the bottom off and draw the lines on the cloth. Thread the shuttle bobbin with "C" or "D" silk (Singer), using also the same on top; fold the cloth to the chalk lines, the long one first, and stitch close to the edge. After the three long lines have been stitched, do the cross lines the same way. Do not have the silk break in between the tufts; if there is a knot in the silk, rip out the tuft. After stitching, flatten down the tufts. Now work up this top the same as the one explained above.

This makes a pretty top, but if you do not wish to stitch it, take $1\text{-}16\text{th}$ in. fulness from between tufts and leave the top plain, but in each case work the top the same. If you stitch the cushion top, do the back the same; if you pleat the top, pleat the back also.—Cooper's Vehicle Journal.

WOMAN WILL HEAD AUTOMOBILE SHOP.

Miss Mabel A. Pitt became the president and treasurer of the Pitt-Matthews Carriage and Auto Company on January 1. The concern is a new \$10,000 corporation, formed by the absorption of the Matthews Carriage Company with the Pitt Carriage Co. Miss Pitt has been president and manager of the Pitt Carriage Company since the death of her father a year ago. The concern was founded twenty-five years ago in Des Moines, Iowa, by John F. Pitt.

E. V. Matthews, vice-president and manager of the new corporation in which Miss Pitt retains a controlling interest, learned his trade under Mr. Pitt, as did R. G. Priebe, the new secretary, who has been with the company for eighteen years.

An addition of 44×132 feet will be built, which will double the size of the two-story brick building at 212-214 East Third street. This new building will be used for auto repair work, especially the painting and fine trimming. Between twelve and fifteen men are now employed at the plant, but the force will be increased as rapidly as the new business warrants.

NOTEWORTHY SHOWING.

Each year at the big motor vehicle shows, Valentine & Company have gathered the data as to the varnish used on the vehicles on exhibition, for the purpose of expressing in percentage form, the per cent of those on which Valentines varnish has been used.

In this issue the figures gathered from the Grand Central Palace Show, and the two shows in Madison Square Garden, have so far been computed, and it has been found that out of a total of 463 vehicles exhibited, a little over 70 per cent were adherents of the varnishes made by this company.

For many years this has been a consistent practice, and the figures have always been of the most gratifying kind, showing a very pronounced balance in favor of the Valentine goods, both varnishes and colors. It is the opinion of the user that counts, not the claim of the maker, unless it has such substantial endorsement; so figures of this kind become very significant. Consensus of technical favor is a very sure guide to excellence, as it is impossible to lead a majority of painters astray, however, it might be with a smaller number. These figures are given as strong testimony.

CORTLAND WAGON CO. IN BANKRUPTCY.

On January 30 a petition in involuntary bankruptcy was filed against the Cortland Wagon Company by Attorneys Dickinson and Duffy, representing petitioners O. U. Kellog, Edward Duffy and the Cortland County Traction Company, creditors of the company. Judge Ray appointed Frank P. Hakes, a local real estate and insurance man, receiver, pending the adjudication order. Hakes filed a bond of \$50,000. A stay in further proceedings on judgments against the company was also issued by Judge Ray.

Trade News From Near and Far

BUSINESS CHANGES.

The Tilson Carriage Co., at Texarkana, Tex., has filed notice of dissolution.

W. S. Uhler (Tipton Carriage Co.), Tipton, Iowa, has sold out to George McLarand.

T. L. Shaper, dealer in vehicles, etc., at Goliad, Tex., has sold out to Dick Lutenbacher.

O. T. Knote has purchased the stock of buggies, etc., of J. T. Knote, in Douglass, Kas.

S. P. Bell has disposed of his stock of vehicles, etc., in Haskell, Okla., to O. B. Bell.

Wayne Munn has purchased the vehicle business of Walter Peterson, in Randolph, Kas.

I. E. Nelson has purchased the stock of vehicles, etc., of J. A. Satre & Son, in Stanhope, Ia.

C. E. Haas has disposed of his stock of vehicles, etc., in LeMars, Ia., to Koenig & Shenk.

Fager & Fager has purchased the stock of vehicles, etc., of Hall & Hall, in Codams, Neb.

H. E. Gray has disposed of his stock of vehicles, etc., in Kent, Iowa, to Gault Bros. & Cromwell.

George W. Miller has purchased the Mitchell Carriage and Implement Company at Albia, Iowa.

Layton & West have succeeded F. E. Layton & Son in the vehicle business in Silver Creek, Neb.

G. Henderson has purchased the stock of vehicles, etc., of Henry Ahlborn, in Smith Center, Kas.

V. E. Bitner has disposed of his stock of buggies, etc., in Ne-
leigh, Neb., to George Fletcher & Son.

J. H. Dunn has disposed of his vehicle and implement business in Irvington, Ia., to Peterson & Nelson.

Gerth & Johnson have disposed of their retail vehicle business in Lambertson, Minn., to Brown & Pooch.

M. L. Parish has purchased the stock of buggies and implements of O. W. Munson, in Fairfax, S. D.

Hunsley Bros. have disposed of their stock of vehicles, etc., in Greensburg, Kas., to Peterson & Peterson.

Isaac S. Trexler has purchased the Warner & McGowan carriage and wagon business at Newtown, Pa.

D. J. Tiefenthal has succeeded to the vehicle and implement business of Bentley & Tiefenthal, in Allegan, Mich.

Olsen Bros. & Day, manufacturers of vehicles at Broadhead, Wis., have dissolved partnership. P. T. Olsen succeeds.

The Nail Manufacturing Co. has been incorporated in Staunton, Va., with a capital of \$15,000 to manufacture vehicles.

T. P. Phillips & Son, dealers in implements, vehicles, etc., at Mt. Vernon, Iowa, have been succeeded by T. I. Mitchell.

M. E. Mills, dealer in implements, vehicles, etc., at Elkhorn, Wis., has sold out to Andrew Bachhuber & Son, of Mayville.

D. A. Andre and C. C. Hoffner have purchased the interests of Jonas Swab and S. H. Knisely in the Swab Carriage Works at Elizabeth, Pa.

Dan L. Schnabel has sold his carriage manufacturing and sales business at Johnstown, Pa., and his general blacksmithing plant on Matthews street to John H. Mason and M. A. Luse.

Charles Meeker, proprietor of the implement store of Meeker & Claussen, Crown Point, Ind., has sold out the farm implement business to Henry F. Batterman. Meeker & Claussen, it is said, will vacate the building and devote their time to the sale of automobiles, buggies and wagons.

NEW FIRMS AND INCORPORATIONS.

John Koehn is about to engage in the vehicle business in Laverne, Minn.

G. G. Stadel is about to engage in the vehicle business in Morristown, S. D.

D. A. Hart is engaging in the hardware and buggy business in Newburg, Ore.

J. R. Davis has engaged in the hardware and buggy business in Janesboro, Iowa.

Mabee Bros. are engaging in the vehicle and implement business in Parker, S. D.

J. A. Hanft is about to put in a stock of vehicles, etc., in Columbus Junction, Ia.

W. H. Gillette Manufacturing Co., capital \$100,000, has been incorporated at Louisville, Ky. The concern will manufacture

buggy, wagon, vehicle and automobile equipments. Incorporators are W. H. Gillette, W. L. Gillette, C. H. Lambert.

M. V. Cochems has opened a new stock of buggies and hardware in St. Anthony Falls, Ida.

W. S. Prettyman has purchased the stock of vehicles, etc., of H. F. Froebe, in Hopedale, Ill.

Hamilton & Freereksen have engaged in the vehicle and implement business in Kanawha, Ia.

Morgan Weaver, of Abilene, is about to open a new stock of vehicles, etc., at McKinney, Texas.

The Caffall Carriage Co. has been incorporated in Beaumont, Texas, with a capital stock of \$20,000.

The Diamond Carriage Co. has been incorporated in Spokane, Wash., with a capital stock of \$85,000.

Kelly Bros., of Wymore, Neb., have sold out their stock of buggies, etc., to J. J. Stilson, of Atkinson, Neb.

W. S. Bogarth has disposed of his carriage business in New London, Ia., to Henry Rausche, of Lockridge, Ia.

Luscaleet & Gale have disposed of their hardware and buggy business in White Heath, Ill., to Teats & Morton.

The Parlin-Orendorf Implement Co. has established a branch implement and vehicle warehouse in Pasco, Wash.

Carver Buggy Co., Hamblen County, Tenn., capital \$50,000; incorporated by C. C. Hale, H. F. Trobaugh, C. D. Trobaugh, F. W. Donaldson and Charles Haltsinger.

Clarence R. Helber and Charles L. Rickard will engage in the general implement, buggy and harness business under the name of Helber & Rickard, at Grand Island, Neb.

The One Buggy Company, Suffolk, Va., has been incorporated with \$50,000 capital stock; J. M. Darden, president; W. S. Bea-
mon, vice-president; C. E. Holland, secretary and treasurer.

The M. F. Carroll & Sons Co., Hillsboro, O., capital \$25,000, has been incorporated by M. F. L. Carroll, J. E. Carroll, E. P. Carroll, J. W. Carroll, C. L. Carroll. The company will manufacture buggies.

The M. W. Hunsberger Sales Company is the name of a new concern at Mishawaka, Ind. A new two story business building is being erected and the company will engage in the sale of carriages, sleighs, wagons, farm implements, harness, etc. The company includes M. W. Hunsberger and Sol. M. Albert, two well known Mishawaka citizens. A feature will be a modern paint shop for the repainting and refinishing of carriages, etc.

IMPROVEMENTS—EXTENSIONS.

Benson Bros., vehicle dealers of Gettysburg, S. D., are erecting a new repository.

The Page-Detroit Motor Car Co., Detroit, Mich., has increased its capital from \$100,000 to \$250,000.

Roland Wiley has moved his buggy and implement business in El Dorado, Kas., into new quarters.

As a result of addition to the plant of the Hercules Buggy Co. at Evansville, Ind., 300 employes will be added this month.

The American Wagon Company, of Chicago, is going to move to Dixon, Ill., and occupy the plant of a former wagon company there.

The Svcamore Wagon Works is building an addition to its shop at DeKalb, Ill. A building 50x150 feet, which will be used as a storeroom, is now in course of erection and will be ready in a short time.

The Board of Directors of the Columbia (Pa.) Wagon Company has called a special meeting of the stockholders for March 20th for the purpose of voting an increase of the capital stock from \$150,000 to \$250,000.

The South Texas Implement & Vehicle Co. will erect a new building adjoining its present location at 601 Prescott street, Houston. This company also has offices and warerooms at the corner of Wood and Walnut streets.

Interior improvements to cost several thousand dollars are now being made by the Kratzer Carriage Company, Des Moines, Ia. The changes will give the concern one of the largest sales rooms in the country, with a floor space of 10,000 square feet and space for 100 vehicles.

The finishing touches are being put on the Eller Wagon Works the newly constructed plant at Houston, Tex., and President Eller says that the company expects to do a \$150,000 business the coming year, the largest in their history. The buildings and

grounds cost \$45,000. The building is three stories in height and covers a 100x100 foot floor space. The Eller Wagon Works expect eventually to cover the entire block upon which the present plant is located. The company's capital has been increased from \$20,000 to \$40,000.

The Michigan Hearse and Carriage Company, Grand Rapids, Mich., has prepared plans for an additional factory building 40x100 feet, three stories high, brick mill construction, to be erected the coming season and which will nearly double the capacity of the plant. The last year was the best in the company's history.

The Peabody Buggy Company, Fostoria, O., has purchased J. J. Eissler & Sons' buggy stock, and the route is to be used by the Peabody people as an up-town repository. The contract providing for the sale and transfer has been signed. Jacob Eissler, it is understood, is to retire from active business, but his son, Fred, will continue in the construction of wagons and doing general repair work.

At a meeting of the stockholders of the Franklin (O.) Wheel Works, the stock was raised from \$50,000 to \$75,000. The board of directors ordered an 8 per cent dividend on preferred stock to be paid January 4 and March 1. One hundred and seven thousand dollars' worth of wheels were shipped from this plant up to January 1, 1911, and there are sufficient orders now in to run the plant four months.

The Borchers Carriage Company, Dayton, O., which for seven years has occupied a building on S. St. Clair, will have for its future home the O. N. G. armory on Sixth street. The first of March the Borchers company will take possession of part of the building, but the main floor will not be secured until after the militia lease expires in a year. The entire building will be occupied by the Borchers Company, which manufactures carriages and wagons.

The Youngstown (O.) Carriage & Wagon Company has plans prepared for a four-story brick building on the new site just purchased at Mahoning avenue and Barclay street. The new building will be modern throughout. A major part of the ground floor will be made into a garage and automobile show room. Attention will also be given to wagon and carriage repairing. A majority of the old stockholders have transferred their holdings to hotel stock and will not be identified with the carriage and wagon works after it leaves the Boardman street site. In the new enterprise Warren C. Williamson will have the controlling interest.

The Model Carriage Co., Houston, Tex., paid \$22,500 for the two-story brick structure corner Franklin avenue and Crawford streets. A new front of ornamental type will be placed on Franklin street, cement floors will be laid throughout and elevators installed for the convenient handling of heavy vehicles and automobile repair parts. The growing business in the present lines covered and the engaging in extensive manufacturing contemplated by the company, has found the old quarters too small, and the company has been negotiating for some time with a view to purchasing suitable property and installing practically a new plant throughout, both for handling their retail trade and the manufacturing of vehicles.

BUSINESS TROUBLES.

Wm. Stewart has been chosen trustee by the creditors of the Indiana (Pa.) Carriage Co., bankrupt.

The W. O. Brown Company, Dallas, Texas, manufacturers of buggies, filed an assignment, January 16, for the benefit of creditors. T. M. Turner was named as assignee. Assets of the company are given at \$147,500, with liabilities amounting to \$115,000.

At a special term of the Supreme Court, held by Justice Howard at Troy, N. Y., January 9, an order was entered on motion of Attorney Arthur Helme of Albany, making Lucius H. Washburn receiver for the Union Wheel and Manufacturing Co., of Coxsackie, N. Y., and fixing his bond at \$10,000. The plant has gone into voluntary bankruptcy.

The appointment of ancillary receivers to take charge of the Washington, D. C., property of the S. D. Walters & Son Carriage Works, has been requested. In filing a petition in the Supreme Court of the District, Zeph T. George, who says he owns 115 of the 125 shares of stock in the corporation which was formed under the laws of Virginia with offices in Alexandria, declares that the assets of the company are \$10,700 and the debts amount to \$8,200.

Charles F. Monroe and John W. Wolf have been named receivers for the Dawson & Wolf Company, of New York, which recently filed an involuntary petition in bankruptcy January 14. The bonds of the receivers have been fixed at \$20,000. Coville & Moore have been named as the attorneys for the receivers, and the same firm also represent the creditors upon whose petition the firm was forced into bankruptcy. The Dawson & Wolf Company has been engaged in the manufacture of wagons, gears, etc., and had employed from 10 to 30 men for some time. The concern has turned out fine work, and seemed to be doing excellently.

FIRES.

The John Deere Co. plant at Omaha, Neb., suffered a \$20,000 fire loss.

The plant of the Haywood Wagon Co., in Madisonville, Ky., has been damaged by fire.

Gage Bros. are rebuilding their vehicle store in Lakefield, Minn., which was recently burned.

The Wm. Mahle Wagon Co., of St. Paul, Minn., has suffered a fire loss of about \$25,000. Insurance \$18,300.

The L. D. Haynes stock of vehicles and implements has been damaged by a recent fire in Vining, Kas., to the extent of \$5,000.

The plant of the Calumet Wagon Works, Chicago, Ill., was partially wrecked, six horses were burned to death and several wagons and buggies destroyed January 12. Loss \$20,000.

The Joliet Wheel Manufacturing Company plant was destroyed January 13. Loss \$110,000. The factory is a mile outside the city limits and the flames were beyond control when the firemen arrived. The plant will be rebuilt at once.

INCORPORATIONS IN THE AUTO TRADE.

Massillon, O.—The Croxton Motor Co.; capital \$250,000.

Jacksonville, Fla.—The Florida Motor Co.; capital \$10,000.

Amarillo, Tex.—The Amarillo Auto Supply Co.; capital \$20,000.

Memphis, Tenn.—The Noble S. Bruce Auto Co.; capital \$10,000.

Milwaukee, Wis.—The Mickelson Motor Co.; capital \$30,000.

St. Louis, Mo.—The Chicopee Motor Car Co.; capital \$8,000.

Chicago—The Grabowsky Power Wagon Co.; capital \$25,000.

Columbia, S. C.—The Gregory-Conger Motor Co.; capital \$20,000.

Pelzer, S. C.—The Saluda Automobile & Machine Co.; capital \$5,000.

Coldwater, Mich.—The Boucher & Moore Auto Co.; capital \$2,000.

Collinsville, Ill.—The Yates-Brooks Automobile Co.; capital \$5,000.

Dayton, O.—Dayton Auto Truck Co., increased capital from \$50,000 to \$200,000.

Detroit, Mich.—Lore, May & Co., capital \$2,000; to manufacture cars and engines.

Indianapolis, Ind.—American Motor Co.; capital \$1,050,000; by J. J. Handley, A. D. Ogborn, J. E. Keperley.

Plainfield, N. J.—Wilcox Auto Co., capital \$25,000; by A. R. Wilcox, A. V. Wilcox and others, to manufacture automobiles.

Port Jervis, N. Y.—Rutan Auto Co., manufacture and deal in automobiles, etc.; capital \$45,000; by Peter C. Rutan, J. A. Rutan.

Chicago—National Motor Device Co., capital \$30,000; to manufacture, buy and sell automobile devices, by J. H. Hoagland, G. O. Garmire.

New York—Price Bros., capital \$3,000 by Jacob M. Price, Fannie M. Price and others; to manufacture and sell trucks, carriages, etc.

Wautoma, Wis.—Security Spring Tire Company; capital \$50,000; by W. J. Durham, F. S. Durham, B. F. Fry, H. A. Fry and G. J. Bruce.

Indianapolis, Ind.—Hardegan Axle Co., capital \$10,000; manufacture and sell automobiles or parts thereof; by E. C. Hardegan, C. W. Lauer.

Moline, Ill.—Velie Engineering Co., electric motors, engines, automobiles, etc.; capital \$200,000; by W. L. Velie, L. M. Fuller, Otis E. Mansur.

Chicago Heights, Ill.—Lalor Wagon Co., capital \$20,000; to manufacture vehicles and automobiles; by M. H. Lalor, D. K. Lindhout and others.

Evansville, Ind.—Advance Auto and Machine Company, capital \$10,000; by Henry Kollker, Walter Wheeler; to manufacture buy and sell automobiles.

Indianapolis, Ind.—Motor Car Manufacturing Co., capital \$75,000, by William C. Teasdale, Fred C. Dorn and others; to manufacture and sell automobiles.

Buffalo, N. Y.—Pneumatic Metal Tire Co., capital \$50,000, by A. E. Nelson, E. L. Kunz and others, to manufacture metal tires and appliances for autos, etc.

Pittsburg, Pa.—Pennsylvania Motor Car Co., capital \$500,000. It will build its plant in the north side and will manufacture a commercial motorcar or truck.

Toledo, O.—Warner Mfg. Co., to manufacture autos; capital \$500,000; by T. W. Warner, E. S. Janney, Nettie M. Warner, Geo. D. Moore, C. S. McCarthy.

Cleveland, O.—Mora Power Wagon Co., manufacturers; capital \$750,000; by Millard H. Nason, Robert P. Abbe, Thomas S. Dunlap, A. T. Hatch, H. A. Mullen.

Jackson, Mich., is to have an electric automobile concern, The Standard Electric Car Company. The capital has been raised and plans are afoot for the building of a large factory.

OBITUARY

Reuben Engleman, Allentown, Pa., died Jan. 2. He was engaged in the carriage making business for many years until July 4, 1909, when he retired, although in good health.

James Bogart, New Haven, Conn., died January 6, at the age of 95 years. Mr. Bogart had been in feeble health for a long time and his death was not unexpected. He was a carriage maker by trade and years ago was in business in New Haven. He is survived by one son and one daughter.

William S. Frasier, Chicago, Ill., 70 years old, president of W. S. Frasier & Co., 371 Wabash avenue, carriage manufacturers, died at his residence at Batavia, Ill., January 18, of heart disease. Frasier was an extensive property owner in Batavia and Aurora. He was president of the Frasier Mfg. Co., of the latter city.

David Kreitzer, 87, Wapakoneta, O., died January 11. He was born in Germany, but had been a resident of Wapakoneta for more than 75 years. He was founder of the Kreitzer Buggy Works of that city. Seven children, five sons and two daughters, survive.

Leonard F. Wood, for many years a wagonmaker in Covington, N. Y., died January 5. He was 85 years old.

David H. Hunt, 82 years old, died at Titusville, N. J., January 18, of old age. Up to a few years ago he carried on an extensive wheelwright business for over fifty years. He leaves a widow, two daughters, one son and three grandchildren.

Henry Katzman, aged 60 years, a retired wagon manufacturer and blacksmith, of Louisville, Ky., died of heart disease on January 5. He was a native of Germany, but came to this country when a young man. He had resided in Louisville for forty-five years, where for more than forty years he conducted a blacksmith shop and wagon manufactory. He retired six years ago on account of poor health. Besides his wife he is survived by two sons and one daughter.

Joseph Zahm died January 5 at the home of his son in Dunkirk, N. Y. He was born in Germany. He located in Buffalo when 18 years old and engaged in carriage building. He lived in Fredonia, 27 years and in Silver Creek 20 years, and in both places worked at carriage building. While living in Fredonia he worked a few years for the Mulholland Carriage Company in Dunkirk. For the last eight years of his life his home was with his son, Stephen J. Zahm. He is survived by four sons, three daughters, 21 grandchildren and three great-grandchildren.

George W. Vinton, at one time one of the principal stockholders in the Buffington Wheel Works at Burlington, Ia., died January 11 at Moline Ill., aged 77 years.

Edward Everett, of Buffalo, N. Y., a recent graduate of the Carriage Builders' Technical School, died on December 3, 1910. At the annual meeting of the Alumni Association of the school held last month, resolutions expressing the sympathy of that body were adopted, engrossed and forwarded to the widow.

ALWAYS DO IT WELL.

The hospitable Automobile Club of America repeated one of its frequent enjoyable afternoons at its clubhouse, 54th street, New York City, January 19. This time it was a recital in the assembly hall, the engaged artist being Miss Katherine J. Everts, and Mrs. Edith C. Goold. As members were permitted to invite two ladies, the function took on all the gaiety, color and delight of a reception of high social degree.

The K-R-I-T Motor Car Co. has passed over to a syndicate headed by Walter S. Russell. The capital of the company is \$250,00, and these gentlemen buy the unissued stock at par. They will also buy whatever stock is not subscribed for by the present stockholders, who have turned back into the treasury of the company a large enough percentage of their holdings on a par basis.

THE BIG FOUR.

The four national organizations most prominently identified with the automobile trade held their annual meetings and elections in New York, viz., the National Association of Automobile Manufacturers, the Motor and Accessory Manufacturers, the Society of Automobile Engineers and the Manufacturers' Contest Association.

The Motor and Accessory Manufacturers held their meeting in the association's rooms, 17 West 42d street, Saturday, January 14, when H. T. Dunn, of the Fisk Rubber Company, Chicopee Falls, Mass., was chosen president to succeed H. E. Raymond, of the B. F. Goodrich Co., who would not accept re-election. Mr. Dunn had been serving as first vice-president and his elevation to the higher office preceded a general moving up. The second vice-president did not join the upward movement. He was not returned to office, and accordingly, C. T. Byrne, of Byrne-Kingston & Co., Kokomo, Ind., became first vice-president. C. E. Whitney, of the Whitney Manufacturing Co., the third vice-president, then moved up to the next peg, the third vice-presidency being filled by the election of C. F. Barnes, of Chicago, representing the Billings & Spencer Co. W. S. Gorton, of the Standard Welding Co., Cleveland, and L. M. Wainwright, of the Diamond Chain & Mfg. Co., Indianapolis, were respectively re-elected treasurer and secretary. William M. Sweet was re-appointed manager of the association.

The reports of the officers showed the organization to be not merely in a flourishing condition, but sound to the core. There are, approximately, \$70,000 in the treasury, and 230 members on the roll, of whom 61 were added during the year.

The meeting of the Manufacturers' Contest Association elected Howard E. Coffin, of the Hudson Motor Car Co., Detroit, president; Howard Marmon, Nordyke & Marmon Co., Indianapolis, vice-president; E. R. Hollander, Fiat Automobile Co., New York, secretary-treasurer. Howard Marmon was elected also to the important office of chairman of the general rules committee. The directors of the association elected include the officers and C. E. Emise, Lozier Motor Co., and W. H. Vandervoort, Moline Automobile Co.

NEW MOTOR COMPANY IN DETROIT.

Vernon C. Fry, who recently purchased the assets of the Detroit-Dearborn Motor Car Co., Detroit, Mich., with the exception of the book accounts, from the Detroit Trust Co., trustees in bankruptcy, states that a new company will be organized immediately. Mr. Fry said: "We will begin this week to turn out cars of the same quality as were formerly made by the Detroit-Dearborn Co., and will go right ahead with the business. A new company will be organized immediately and it is probable that I will be president."

VELIE AUXILIARY TO MAKE MOTORS.

The Velie Engineering Company, Moline, Ill., has been incorporated with a capital stock of \$200,000. The incorporators are Willard L. Velie, Lawson M. Fuller and Otis E. Mansur, all of Moline. The object of the corporation is to manufacture automobile engines, automobiles and accessories.

The Velie Engineering Co. is an independent corporation, though its stock is held by owners of the other Velie concerns—Velie Motor Vehicle Co. and Velie Carriage Co.

A \$160,000 plant for the engineering company has just been completed in the east end of Moline and is being prepared for operation, manufacturing to begin within two weeks. Engines for Velie automobiles will be the sole output for a time, but the intention of W. L. Velie, the controlling member of the corporation, is to enlarge the plant in time with a view to manufacturing, not engines only, but all parts for the Velie automobiles that are at present manufactured by accessory concerns in the East and Middle West.

AFTER "DE WAH."

The Motor World, in its account of the A. L. A. M. banquet in New York, thus describes the only incident of interest:

"The war is over. The lawyers are being paid and the pipe of peace actually has been smoked. It was smoked at the annual dinner of the Association of Licensed Automobile Manufacturers which occurred in the Hotel Astor, New York, on Thursday, January 12, and which, like a once widely advertised patent medicine, was "peculiar in itself." Due to the curious whirligig of time, and also to a decision of the United States Court of Appeals, it seemed that napkins with mourning borders should mark the occasion, but instead, it developed a "hero," and the "hero," strange to say, was not a licensee. Although he did nothing more than bow and try to appear at ease, Henry Ford, for so many years the chief and unrelenting adversary of the A. L. A. M. and its Selden patent, was "the man of the hour." If Ford was a glorious fighter, the A. L. A. M. proved itself an equally glorious loser. The scars of war were washed away with wine."

It seems the carriage builder is butting in, though classified as "an automobile body maker." Mr. Henry M. Duncan, whose post-prandial oratory is of the genuine kind that has the trade mark blown in the glass and the bottle, made a pronounced hit. It was a foregone conclusion that he would, so it is not news.

PARRY PLANT IN FULL SWING AGAIN.

The Motor Car Manufacturing Company is the name of the new concern which will operate the defunct Parry Automobile Company plant at Indianapolis, Ind. The officers are: W. C. Teasdale, Jr. president; G. O. Simons, vice-president and superintendent; W. K. Bromley, secretary, all of Indianapolis, and Fred C. Dorn, and Frank H. Teagle, of Cleveland. W. C. Teasdale, Jr., was formerly connected with the Parry Automobile Company. Mr. Simons came from the Dayton Motor Car Company, and F. C. Dorn is treasurer of the American Ball Bearing Company, of Cleveland. F. H. Teagle is said to be a director in the Standard Oil Company. It looks like a strong organization, and with the well known Parry work as a basis for its future operation it promises to look after the old Parry dealers, and to give to Parry owners the special service to which they have been accustomed. The line of cars for this year will range in prices between \$1,350 and \$1,750.

NEWARK AUTOMOBILE SHOW, FEBRUARY 18-25, 1911.

With the First Regiment Armory taxed to its utmost capacity to accommodate the exhibits, Newark's fourth annual automobile show, during the week of February 18-25, will surpass in the number and variety of cars any show ever held in the State, and will take rank with the national exhibitions. With a few exceptions every standard make of pleasure car sold in the East, ranging in price from \$400 to upwards of \$6,000, is included in the list of exhibits.

The committee found itself confronted with the problem that there were applications far in excess of the space available. After the space allotments had been completed it was found that no less than fifty-two separate dealers will have exhibits of pleasure cars alone, comprising a display of more than one hundred and seventy-five separate and distinct models. In addition, there will be at least forty different types of commercial cars on exhibition, ranging from a light delivery wagon to the huge five-ton trucks.

TO REPRODUCE EVERITTS IN CANADA.

The Tudhope Motor Co., of Orilla, Ont., has closed negotiations with the Metzger Motor Car Co., of Detroit, for the Canadian rights to manufacture the Everitt "30." The necessary duplicate tools and machinery to reproduce the car on the other side of the border already have been installed in the Tudhope plant and manufacturing operations are in progress.

FLANDERS GROUP.

What in Michigan trade circles had come to be known as the "Flanders Group" of factories, although none bore that name, are now one company—the Flanders Mfg. Co. The companies consolidated are five in number, viz., the Grant & Woods Mfg. Co., of Chelsea, Mich., which manufactures automatic machinery, machine screw parts and steel balls, and the Pontiac Motorcycle Co., Pontiac Drop Forge Co., Pontiac Foundry Co. and Vulcan Gear Works, all of Pontiac, Mich., the nature of whose productions is indicated by their respective titles.

The Flanders in the case is Walter E. Flanders, president of the E-M-F Co., of Detroit. All of the Pontiac plants are reared on the same extensive plot, and, so to speak, their roofs almost touch.

The Flanders Mfg. Co., which takes over the five properties, has applied for a charter under the laws of Michigan, the capitalization being \$2,500,000, divided into 22,500 shares, of which 15,000 shares are common stock and 7,500 7 per cent cumulative preferred stock; each share holder in the old companies is given the option of accepting his pro rata share in either common stock or one-half common and one-half preferred.

Flanders and his associates are in absolute control of the five companies, and, of course, will prevail in the Flanders Mfg. Co. The first board of directors is as follows: Walter E. Flanders, Dr. James B. Book, William T. Barbour, president Detroit Stove Co.; Clement Studebaker, Jr., South Bend, treasurer Studebaker Bros. Manufacturing Co., of South Bend, Ind., and of the E-M-F Co.; Robert M. Brownson, president Pontiac Motorcycle Co.; John T. Shaw, president First National Bank, and Arthur O. Smith of Milwaukee, who is head of the enormous steel stamping plant which bears his name.

Although associated with Flanders in the E-M-F Co., which is owned by the Studebaker interests, the appearance of Clement Studebaker in the directorate of the Flanders Mfg. Co. is the most significant feature of the transaction; previously none of the Studebakers had been identified with the "Flanders group."

AN EFFECTIVE FOOT WARMER.

At a total cost of less than a dollar, it is possible to provide an effective foot warmer for one, if not more occupants of an automobile, according to Mr. J. S. Johnson, assistant principal of the Automobile School of the West Side Young Men's Christian Association, New York City, who claims once the warmer is installed the upkeep is nothing. Mr. Johnson has fitted up foot warmers for the automobiles used in giving road lessons at the school and says they are excellent.

The warmer is very simple and can be installed by any man who has a little mechanical skill. First, Mr. Johnson cut out a section of the automobile flooring in front of the seat next to that occupied by the driver, and over this he fitted a register such as is used in house walls or floors in connection with hot air furnaces. The exhaust pipes, which are always hot when the engine is in operation extend under this part of the automobile. The heat from the pipes comes through the register and for the person on that side of the front seat provides "feet as warm as toast." So that there will be no loss of heat a piece of sheet iron is run from the engine pan and fastened to the bottom of the car flooring and this forces all heat up through the register. In automobiles having foredoors, wind-shield and curtains the foot warmer will give heat to everyone in the car.

GOODRICH WINDOW DISPLAY.

A window display that is proving very interesting to the public has just been installed at the headquarters of the B. F. Goodrich Company in New York City at 1780-1782 Broadway. It represents the tapping of rubber trees in the Para regions of South America, and making the crude into biscuits at a natives' camp.

Madison Square Garden Automobile Shows.

PART I. PASSENGER CARS.

General Observations—The show in the Garden in New York was much greater than any previous gathering of cars and accessories. The attendance was very large, and if any large proportion of it really gave up coin of the realm just for the privilege of walking through a vehicle repository to look at the style of carriages, then the outcome must have been very flattering to the management. We hope it was.

There are always great reports of the business done. Of course, it is very nearly impossible to verify such rumors, and it is not important to do so, in any event. But there must have been sales in quite large volume, if there was anything but a look-fest going on at all.

In the matter of decoration and arrangement, much taste and good judgment was in evidence. There seemed to be more room for the curious to circulate, and to gather a collection of literature. The literature was very well worth while collecting. As examples of the art of fine catalogue printing and illustration in color, it was expensive far beyond the general run. The profit must be juicy to afford such extravagance. A collection, and a study of the matter in the catalogues would be the very best education for the prospective buyer. It is entirely possible to learn the fault of every other type of machine by reading of the virtue of the one under discussion. The "knocking" is done along the most gentlemanly lines of discussion, without reference by name to the party of the second part, of course, but by the neatest allusion that is tantamount to a full and sufficient disclosure. A careful collating and study of this literature will be worth the while of anyone who wishes to keep informed.

In a journal like *The Hub*, the very many niceties of the mechanical construction of the power plant are something the maker is supposed to know or to find out for himself, but it is our province, perhaps, to point out the really new departures, if any, and to take cognizance of the carriage body work. This hitching a mechanical horse to the job and building it into the structure, makes it hard to decide just where the horse's tail ends and the job begins. But as the horse precedes the vehicle, we will consider his style and conformation first.

The Power Plant—The great majority of the motors were of the four-cycle type. Of these, the only rank that seems at all crowded is the first rank, as the invariable claim seemed to be that this motor (one under consideration) stands in the front rank. This is a quoted expression. The most urgent claims seemed to be that the cost of up-keep, the service in mileage that a gallon of fuel would render, and the accessibility of parts, were just the acme of perfection. There was much stress, too, laid on the number of parts that had been found to be superfluous, and which were conspicuously absent in "our" machine. There have been great strides made in this direction, without any doubt. The main features of the four-cycle type were a refinement of parts, simply, and a doing away with all the clatter of small parts that could be dispensed with, so as to bring about "the great silence." The influence of that ingenious American, George Knight, who had to go to England to sell the patent on his sliding valve motor, because there was not enough mechanical perspicacity in this country to see the trend of a coming event, is now leavening the whole lump of the work in this land. We are always just that progressive. We come in when the dollar shows up, and the other fellow has blazed the new path. We will show the very greatest ingenuity in ducking around the patent, and making something "just as good," or very much better, and in this effort the mechanical freaks we will produce will keep our museums full of novelties of that kind.

The real new things were shown among the "accessories," and if a builder should "build" by judiciously picking up among the good things the parts he needed, and assemble them, he would have more of a novel machine, and a very much better construction than many of the products that were shown on the floor of cars. And he could buy absolutely everything he needed in the way of material, from a nut up to the paint that gives the finishing touch, everything included. That part of the exhibit was really illuminating, and was a great compliment to the art of the specialist.

The pattern of motor most in evidence, or rather, perhaps, of motor cylinder, was what is called the T-head, originating in France, of course, and gently adopted and adapted by our original thinkers among our engineers. Variations from this type were instances of some fellow really having had a thought of his own, and trying it out as best he could, at the expense of sympathetic purchasers, who are always the real experimenters with their solid cash.

The effort to secure silence of operation is leading many to the six-cylinder four-cycle type. It is more expensive, but the eloquence put into play to tell of its advantages glosses over the mere item of cost. A little time back these same makers described it as a harmless fad, but it is different now. *Tempora mutantur*. There is also some talk about it being possible to start up on the spark. One maker tells how undignified it is to be seen turning the handle of the organ in front before the music can be made. He is a crank on cranking, probably. At any rate his machine will really start from the seat about every time it is tried. This man has been a consistent 6-cylinder advocate and practitioner for some years, building no other kind.

There were several examples of the friction disc transmission. Those not using it referred to it in words that might be said to be equivalent to "damning with faint praise," overlooking the fact that not one of them employed a clutch that was not a friction clutch, and depended for its power solely on the principle of friction to get the power from the engine to the transmission. To one not owning a car, but merely a listener in Vienna, with no favorites to play, this was all very amusing. And the comments of the possible purchaser were eloquent with the power of "suggestion." He had learned his lesson, and spoke very learnedly about his doubt as to the friction transmission being able to deliver the power, and in the next breath entered into a dissertation about the comparative merits of cone or disc clutch, ignoring that he was talking about the power of friction, as it was the only power used. It was very interesting.

There is a kind of show that it would be well worth paying money to enter, not saying that this one was not. It would be a show of these same exhibits after six months service, and being run by their own power with wheels jacked up, and then listen to the explanations of the demonstrators. The band in the gallery would not be needed to make music. It would be a survival of the fittest show, and our friends in the accessories division would point with pride at some of their ready-made cars.

The lengthening of the stroke to five or more inches is another leaf from the European text-book that was put into practice in many cases. We will now hear much about the fewer number of revolutions per minute to produce the same speed, other things being equal, also how much more than the ALAM rated horsepower is being delivered.

The reporter noticed a very interesting incident, well illustrating the course of original thought that is such a conspicuous attribute of some of the builders. There is a car made in France by an ex-American gun maker. It is produced, we think, from

his patterns, in this country. Nice car. A salient feature is a front axle, that for design and strength is uncommon. It is a model for such construction, one might almost write. "Made in France," of course. We noticed the draftsman of one of the large concerns making a sketch of it, probably with the permission of the exhibitor. Next season we will very probably see it in another car and "our people" will point it out with proper pride as one of the many improvements "our" factory thought out, tested and adopted as just the right thing, and an advance in practice! One of the many advantages of a show like the one under notice is the wide opportunity it offers to the manufacturer to absorb his "original" thought, and copy it on paper. It then becomes his own thought, why not?

The two-cycle motor made a modest presentment of its claims. Models show a great advance over previous ones. Anybody looking for "the silence," and a relief of the pressure of up-keep expense in the pocketbook, should give a good deal of attention to this type. We would recommend consideration of the type to carriage builders who intend to venture in the motor car field. The only drawback of importance is that the good features are covered by good, healthy patents of considerable longevity, while the 4-cycle proposition is now, or soon will be, entirely free from proprietary rights.

Body Styles—We would like to have had the chance to find out who built some of the work not put up in the factories of chassis builders. But it is a delicate question to ask, and could only be answered as a matter of politeness. Where the body was signed by the builder's name it was easy, of course.

The most striking aspect of the body styles was the deathly monotony of form. There was about as much variation in the general run of the work as there is in peas in a pod. Touring car bodies differed mainly in the painting. There was but little variety in the color scheme, even, and when some painter did mix up the colors on his palette, the result made you wish he had continued to follow the accepted monotony. (The exceptions we will leave to the last, just as the dessert finishes the repast.)

There were not so many of the wedding journey variety of car as we have previously seen, but the few examples kept the tradition good as being the most pronounced freaks a color-and-trimming-blind constructor could possibly put together. It would not be fair to wound the susceptibilities of some maker by accurately characterizing them. He, no doubt, derived comfort from their contemplation, and supposed others did, also.

There was one touring body shown on a car that ought to command attention anywhere for the very clever and artistic method of treating what was in fact a proposition of parallel lines converted into very pleasing sweeps, of great beauty of line. And the color scheme was on a par with the excellence of the designing. It was the only one in the show that the reporter saw, and he thinks he saw all of such cars that would be a credit to any carriage builder of the very best class. It ought to have been put in a glass case on the first floor and marked "hors concours," not that many of them would have known what that means.

The mechanical dexterity of the work was fair to good in almost every instance. The painting was skillful, the trimming well done. Following the lead of a very fine New York builder who saw the artistic possibilities of low-toned colors with broad lace to harmonize, there was a very general copying of this idea. The effect was something like eating thirty quails in thirty days, good, but a little tedious.

One concern whose product is justly regarded as fine had some very handsome models of the best French designs, turned out as to painting and trimming, as finished as one likes to see. There were no lapses from good taste, although there was a red and black coupe that we would suppose would go better with a bromo-seltzer clientele. But it was a point of color in the scheme of the exhibit and may have been deliberately planned.

Another concern of the very best repute repeated its hotel on wheels, that was so successful in attracting attention last year. The work was very heavy, as it had to be, and was well designed

and colored. The leather trimming would have been good anywhere. The door panels used for the monogram, usually, carried oil paintings of landscape views. These were very fetching to the crowd. The side body panels of our New York furniture vans are similarly, but crudely decorated, so the stunt had established custom to excuse it, if any excuse was necessary, and probably none was. It was named a touring landau.

It was very curious to listen to the chance remarks of visitors. After looking over the exhibit and missing a torpedo body with a pointed tail like the fighting end of a wasp, there was always a call to be shown this thing of beauty. No exhibit was entirely complete without one of these, if the public was to be believed. Also, if there was a car that had done some awful speed stunt and had the mud and other stains of the contest on it as the warrior has his scars, that was the thing that caught the crowd. They gazed and gazed as if expecting the car any minute to clear its horn and squawk out its tale of prowess. Achievement is the thing that counts with the fifty-cent bourgeoisie.

There were examples of very nicely finished work, indeed, by Holbrook, and probably by others, unsigned as to body.

As pretty a carriage as we saw was a cabriolet by Flandrau. You expected to see the stunning looking woman reclining in it and the park for a background to the picture. It was on a Mercedes or Stearns chassis, we forget which. But it was elegant through and through, and such a refreshing contrast. The same maker supplied the Stearns with a Landau body that was beautifully worked out in its details, and as for design, well, it was Flandrau—that is praise all understand.

The Stoddard-Dayton also showed an inside-drive coupe that was very nice, indeed.

Moon Bros. displayed a coupe with arched roof and interior wood finish that looked very chic.

The Palmer-Singer people added a detail to one of the landaus on exhibition, that was a sensible trick. It was an electric bulb arranged on the sill in such fashion that when the door opened the current was turned on, giving light for the passenger to enter or exit at night without groping for the step.

PART II. BUSINESS VEHICLES.

Following the big show in the Garden the following week was devoted to the exhibition of motors and bodies suited to the needs of business. The number of vehicles were reduced about one-half in volume, but were varied in style and interesting. Most of the accessory makers retained their spaces, and the show was supplemented by a fine display of motorcycles.

Every style of heavy and light body was in evidence, the work being of superior character. The power plants represented the verticle and the horizontal-opposed types, the four-cycle and the two-cycle, water and air-cooled practice.

The W. H. McIntyre Company had several samples of the work just as turned out for the trade. Of it the company says: "This truck fully solves the problem of up-to-date merchandise transportation. Without weak points, as every part has been specially tested and tried out, we offer this truck at a popular price, knowing that the demand will readily justify our decision to furnish at a reasonable price a truck which in accessibility, simplicity, abundance of power, mechanical correctness, and above all, in sturdiness and in get-there-and-back ability, is unrivaled. Our heavy duty motor is without question the best for this class of work. It has specially large bearings, fitted for heavy duty work, weighs 440 pounds. A positive automatic governor is attached, absolutely preventing overspeeding—the source of 90 per cent of all motor truck troubles. No other 1-ton truck, regardless of price, is the equal of this model XIV in serviceability and durability."

The Alden-Sampson Mfg. Co., a branch of the United States Motor Co., had a fine display of work, showing several kinds of bodies. We quote what the company has to say for itself: "Within six months after the Sampson was perfected, forty-six automobile manufacturers in the United States tried to buy the Sampson

patents. This was the recognition the Sampson truck received. It was the greatest tribute ever paid an American truck. The Sampson line is a complete line—the most complete line made. It is built in six sizes. There is a size for every need. We are particular on that score—to adapt the sizes to the work required. And the beauty of it is that the Sampson, on account of its strength, its long life—made possible by its large wearing surfaces and its proven design—will carry this five-ton load close on to 150,000 miles before the Sampson reaches old age. Motor trouble in heavy trucks has been traceable to severe and constant shocks. In the Sampson this trouble is solved by the use of spring suspension and large bearing surfaces in the working parts. The motor is suspended in front on heavy springs which assume the heavy vibrations. This is a particular feature of the Sampson. In all Sampson motors special attention has been given to the size of bearings."

The American Locomotive Company had a number of the Alco trucks to show buyers. Descriptively the company says: "The truck is not an upstart. It does not represent the afterthought of a manufacturer of touring cars. It was the foremost thought of the officers of the company when that engineering organization first established an automobile department in 1905. The Alco policy requires also that instead of the company going into the market and purchasing its axles, jack-shafts, brackets, torsion rods and other such essential parts, these are especially forged in a plant with facilities second to none in the world. The same great forging hammers that turn out axles, connecting rods and other parts for big locomotives, make also the forgings for the truck. The result is an engineering product of proper balance engine for load, strength for capacity, of speed, weight and dimensions, the scientific balance in just the proper quality of metal for each part, and finally the commercial balance of perfect fitness for its work. The motor is so set in its place that by taking away the front cross-bar of the main frame, which is simply bolted in place, and removing the radiator, the complete motor may be drawn out from the front of the frame. This balance in design effects such a distribution of the load as to afford a striking economy in tires, also."

The "Rapid" one and two-ton trucks were of the stake body variety. Prices go a trifle under the three thousand dollar mark. The type of engine is of the familiar kind with special refinements built to meet the varying conditions of load. They say: "In order to complete the Rapid line of trucks to meet every requirement of the commercial world, we have this year added two distinctly new models of one and two tons capacity, with four-cylinder, four-cycle motor under a hood. The engine is said by automobile experts to be the smoothest running, most powerful, and simplest in design of any now used in trucks of the heavier types. The four-cycle, four-cylinder motor in the 1911 one and two-ton model is distinctly new in its design. Simplicity and strength have been the foremost considerations in their sturdy construction. An amplex of reserve power has been provided for hill climbing and hauling full capacity loads."

The Metzger Motor Car Co. showed examples of the Hewitt truck. This company builds as high as ten tons capacity. The claims are that "while we have made the necessary improvements to keep in advance of the trade, none of the Hewitt trucks have ever been discarded, and with the exception of two that were destroyed in a Boston garage fire, they are all, as far as we know, in regular service to-day." Speaking of the motive power it is suggested that "As the motors take up no room on the chassis which could be used for loading, Hewitt trucks have long platforms and short chasses. The weight is carried by both front and rear axles and not by the rear axles alone, thus saving wear on tires and concentrated strains. The advantages of planetary transmission are, that in starting, the power is applied gradually and sudden jerks are avoided; the gears are always in mesh and cannot be stripped; when starting or pulling steep grades under full load the gears rotate only, at other times the entire gear box revolves as a unit, saving all wear on the gears. The speeds

two forward and one reverse (generally used as a brake), are operated by pedals. Change of speed is effected by simply shoving a pedal forward; this will also release any other speed which may be engaged."

"Peerless motor trucks represent the most highly developed practice in design, material and workmanship," say the makers. "No experimental or untried features have been incorporated but the introduction of many refinements and improvements have contributed to the reliability and economy of the Peerless trucks. Notable points of superiority are the low center of gravity without sacrifice of road clearance; large diameter of driving wheels; the slow-speed, long-stroke motor; the four-speed selective transmission, and the accessibility and simplicity of all working parts. All parts have been designed and constructed for these trucks and no pleasure car parts are used. Peerless trucks are constructed entirely in the Peerless factory."

The Brush single-cylinder car was shown as a light delivery with covered top, price, \$650. Their claims are that the cost of maintenance, as well as the depreciation is so much less than that of any other automobile, that there is no chance for argument. This has been proven conclusively by their use by salesmen, physicians, contractors, collectors, artisans, R. F. D. carriers—by people in all walks of life who require some sort of transportation. Some of the engine features are: Motor, 10 H.P. balanced single cylinder, four-cycle, vertical, 4 in. by 5 in., water-cooled; located in front, under hood; every part instantly accessible; three-point suspension. Balancing, after balancing by the usual counterweights, one extra loaded balance gear, driven by a crankshaft gear is applied, the result of which is to take out all of the vibration due to reciprocating weight and in addition most (or at times all) of the torque vibration—theoretically in better balance than a four-cylinder motor. Transmission, internal gear type, perfectly quiet; multiple disc clutches for high, low and reverse; entirely enclosed and absolutely oil-tight driven through universal coupling shaft. Springs, spiral, located at extreme four corners; absolutely the easiest riding springs on any car and mechanically impossible to break. Body, hardwood frame, steel panels in both sides and doors, rubber top. Axles and frame, oil-treated, selected wood, oak, hickory and maple; wonderful for strength, durability, lightness and flexibility. Capacity, carrying compartment, 51 inches long, 37¼ inches wide, 52 inches high. Guaranteed to carry an average load of 600 pounds. Weight, 1450 pounds. Color, dark green body and red running gear.

The Pierce-Arrow people have this to say in favor of the way they do it: "The 5-ton truck is of a type having the motor in front of the dash, with the driver directly behind. The control is practically the same as is used in Pierce-Arrow touring cars; we have found this arrangement to be greatly preferable to placing the driver over the motor, as in this latter position there is too great weight on the front wheels, making driving very difficult and rendering the motor quite inaccessible. The rear wheels are located very nearly in the center of the length of the platform, thus placing practically the entire load on the rear wheels, this being the European practice. With the weight thus distributed the traction is much more positive and the problem of the tires is taken care of by making these sufficiently large to carry the load; increased braking ability is afforded as the rear wheels are not so susceptible to being locked and skidding is not so liable to occur."

The Morgan Motor Truck Co., "master builders of power trucks," lets Mr. Morgan convey the argument to buyers. He talks engagingly as follows: "The Morgan truck was designed developed and built as a truck. It is not merely a wagon with power nor an overgrown touring car. The truck is composed of five units—the motor, the transmission, the jack-shaft or differential and the axles. Each unit may be examined, removed and replaced independently of any other, and without in any way disturbing the load. The engine is in the cab, between the driver and the helper, where it may be readily observed during operation. This compact arrangement gives greater loading space, saves a great deal of room when the truck is backed up to the curb, and by

more equally distributing the weight on all four wheels effects a great saving on the tires. I have never known a mechanical criticism of a Morgan truck that can be sustained. By that I do not mean that my truck is perfect, but after having the best advice obtainable I am not able to improve it—else I would."

The Knox Automobile Co. makes a great feature of fire apparatus work, as well as showing a very wide range of wagon work including hospital service vehicles. The makers say: "In purchasing a motor vehicle you must bear in mind that no manufacturer has succeeded in producing a fool-proof article. A truck must be classed as a piece of machinery and loaded, operated, inspected and cleaned in a manner to bring the best results. This treatment, or the lack of it, will in the end mean the success or failure of the vehicle, no matter how nearly it may approach perfection. Good, competent men can be easily secured at a moderate salary and can easily learn not only to operate cars, but to do all necessary work to keep them in good order if given the opportunity, and should be made to understand that the care of the car is as important as its operation. Knox motors are all of the valve-in-the-head type. The heads are detachable and valves seat directly in the head casting without the resort to valve cages. This is a distinct advance in cylinder construction and has been a feature for three years. The spark and throttle are controlled by levers directly under the steering wheel. The throttle is also controlled independently by an accelerator pedal. The normal speed of the motor while running free is determined by the position of the levers and the speed of the vehicle on the road is controlled by the right foot. The clutch and service brake pedals are at the back of the steering column while the gear change and emergency brake levers are directly beside the driver. On the road, with the exception of the gear changes, the vehicle is controlled by the feet and both hands are free for steering."

In the Autocar exhibit was shown the Bellamore armored motor bank car, something quite novel in the way of a pay car. The Autocars proper were of some variety of body design. The stated claims are: "By the location of the driver's seat over the motor a maximum body platform with a minimum wheel base is attained. This arrangement insures greater accessibility of the power plant, the complete seat structure being hinged for easy access to motor. We emphasize the fact that the cars described are in no sense adaptations of pleasure cars, but are special both in design and material, with the single end in view of continuously meeting with the utmost economy in fuel and maintenance the hard service that will be exacted."

Another of the United States Motor Company's wagons is the Grabowsky, the child of the brain of the inventor of that name. The company gives the inventor the following send-off, which is very flattering: "He is the one man in the industry who has kept up with the times, in the way of practical commercial design, having invented the Grabowsky removable power plant, hardened steel bushings, emergency condensing chamber in the radiator. These and other children of his brain have been pronounced by experts as revolutionary in automobile construction." The removable power plant is located in front under the hood. By merely removing four bolts and loosening six quick-detachable connections, it can be drawn forward, or completely removed in a few minutes, placing the entire power plant, (which is the heart of the automobile) at one's finger tips, making inspection and adjustments easy at all times, and same power plant is again replaced in an equally short time.

The White trucks were well displayed. They were all of the gasoline type. In explaining why the goods are superior, the company says: "The White gasoline trucks are made in three models—the 3-ton truck, the 1½-ton truck and the 1500-pound delivery makes the power perfectly suited to most efficiently meet the requirements of the varied capacities of the three models. The running gears of the 1½ ton and 3 ton trucks show considerable divergence in design corresponding with the differing loads for which they were designed. For example, the smaller truck has a shaft drive and the larger truck is chain-driven.

The White motor is of the long-stroke type, the cylinder dimensions being 3¼ inch bore and 5½ inch stroke. The stroke is longer in proportion to the bore than in any other American car, this being one of the distinctive features of White construction which accords with recent foreign practice. The well recognized advantages of the long-stroke are, increased power, higher efficiency and greater economy. It is not possible to estimate the horsepower of a long stroke motor by the use of a formula which takes into consideration only the bore, and does not consider the stroke. Experience has shown that the power of an engine depends as much upon the length of stroke as it does upon the bore."

The Packard people showed only a few examples of the very extensive line of bodies with which they supply customers. The general idea of the power plant is the same as is used on the pleasure car; in some of the lighter examples it is just the same. The work had the usual finish for which the company has a fine reputation.

The "foreword" of the Overland has the following quotation which seems to be the "brief" of the commercial car pleader, so we give it here: "One by one the more progressive merchants have investigated this new method of delivering goods, and where honest investigation is made there is no room for skepticism. Once this painstaking investigation is given, the facts point in but one direction. Their testimony is all on one side. Up to but a few years ago the commercial automobile industry had been doing strictly pioneer, hard, uphill work. The latter was due to the cry of the pessimist and to the skepticism of the business man, who thought nothing of expending thousands for a pleasure car, yet when it came to a business machine, hesitated. He had to invest in futures, and if he had a substantial capital tied up in horses and wagons, was naturally loath to part with an absolute certainty that cost him more to operate, in favor of one that simply promised to cost less." The reason why the Overland should be bought is given in the following from the company: "The cars were created after motor car construction had very nearly attained perfection. Its designers had no experiments to make. Exact knowledge of correct materials and construction was at hand; in fact, the same engineers and mechanics who had formerly built successful high-priced cars were employed to build Overlands. With facilities for a large production, a superior mechanical equipment and a system of manufacture thoroughly economical, we are enabled to give more good value than is possible at equal price in any other car of either domestic or foreign manufacture."

The Franklin air-cooled motor was to the front. The company had a nice depot bus, and some light delivery work. The claim of the Franklin is lightness and strength of the wood frame, and the lack of engine trouble by the use of the system adopted.

The Locomobile Company made the point of building work on the chassis of rebuilt engines that had been used for pleasure service. The argument is that the mechanism has already been tried, as well as the chassis, so you get a very cheap priced car with the best of machinery made to be originally sold at a very high price. Fully guaranteed, etc.

The Garford claimed to have "the" feature in a friction disc transmission of some novelty. Let them tell about it: "One of the practical difficulties with which some team users have to contend in adopting power wagons is the fact that their drivers are all trained to some particular trade or practice, and the ordinary type of gasoline truck requires either the training of these men to the dexterity necessary for the successful and economical use, or the employment of professional chauffeurs, who in turn have to be trained to the particular business in hand and who are seldom adapted to it; or else the situation requires the compromise of the added expense of a helper on each vehicle. This important consideration was the incentive of the Garford company which led to their adoption of the friction disc transmission. Not only does this demand less manual dexterity in operation than any other form of gasoline truck, but the fact that the change of

speeds does not take place in steps, relieves the operator of the necessity for using anything like the degree of judgment as to "changing gear" which can only be obtained by the ordinary man after much practice. With the friction disc, reductions of speed can be regulated to a nicety and soon become an almost subconscious habit with the driver in accommodating other traffic and the conditions of the road."

The electrics were finely represented by the Studebakers, the Lansden, the General Vehicle Company, Hupp-Yeats and one or two more.

All had fine examples of work in many different styles and with the Edison or the Exide batteries. The claims were fully equal to those made by the gasoline propositions and it became a matter of the buyer deciding by the conditions of his work which he ought to have.

The show in its entirety was very instructive for those investigating different plans, and will no doubt be productive of substantial results.

FLANDRAU AUTOMOBILE BODIES.

(See Fashion Plate Illustration.)

The work of Flandrau & Co., of Broome street, New York, has always been in the quality class. Their horse-drawn vehicles were always types of the highest excellence. When the firm addressed itself to automobile body making, their's became the touch that changed a design from the ordinary to the particular and exclusively elegant. We present a late model in this issue, and describe the body, along with other recent creations that attracted most marked attention at the automobile show in Madison Square Garden.

"Woolworth" Limousine on Hotchkiss Chassis.—A light but roomy body made entirely of wood except the lower quarter panels which are hammered aluminum; frames of mahogany edges with anti-rattling rubber tubes and having a wind shield bent inwardly and outwardly for rainy and snowy weather; painted a royal blue color on the panel with black upper parts and mouldings striped with a cream color; trimmed inside with the latest color of Bedford cord with a light touch of blue finished off throughout the interior with a broad lace matched by a narrow lace having the main colors of the trimming upon the ground work of dull gold. The silk curtains to the windows and the carpets on the floor match in harmony with colors of the interior, all of the trimmings being imported especially from Paris, France, and made especially for this car, and are the costliest and finest trimmings brought to this country. Not only is it beautiful in appearance, but its fine quality being a guarantee of its service; the springs of the seats are especially made for the car, nothing but the purest of white curled hair is used; trays with watch, scent bottles, memorandum pads, card cases, cigar tray, watch with electric light, hand mirror, coat hooks, foot cushions, megaphone, electric light in dome of roof, and the outer lamps also being lighted by electricity.

Against the division inside are placed two chairs or emergency seats which also have backs, making them much more comfortable and so placed that one may sit facing opposite door and towards rear, and folding up out of the way and taking but little space and yet have room.

Chassis mounted with four sheet steel fenders with inner and outer skirts protecting body and hood from mud, running boards covered with rubber, edged with corrugated brass and protected with mud skirts, and chassis painted in harmony with body.

"Miller" Landaulet with Hotchkiss Chassis.—This is the lightest and smallest landaulet to carry four or five comfortably; the style is the round cornered pattern adapting itself well to the frame and to the light appearance of the body; top lets down, the windows disappearing in doors and front, making an open car for winter or spring or summer touring; having at the dash a wind shield opening inwardly and outwardly for rainy and snowy weather; painted a light shade of Flandrau green, which makes a

beautiful shade and lightness of appearance of the body and is most attractively set off with the black mouldings that bring out the beauty of the dominant color; the mouldings are stripped in white.

The trimming is of a grayish type of striped cord, a novelty just imported from Paris, with lace that matches, and makes it an extremely attractive interior. There is also furnished megaphone, trays having memorandum pads, card space, ash receiver, scent bottles, hand mirrors and foot cushions.

Against the division inside are placed two chairs or emergency seats, which also have backs, making them much more comfortable and so placed that one may sit facing opposite doors and towards rear, and folding up out of the way and taking up but little space and yet have room.

Chassis mounted with four sheet steel fenders with inner and outer skirts protecting body and hood from mud, running boards covered with rubber, edged with corrugated brass and protected with mud skirts, and chassis painted in harmony with body.

"Pratt" Inside Drive Landaulet, on Stearns 15-30 Chassis.—This is a most unusual body and a distinct novelty inside drive landaulet. Landaulets are generally sold with the tops down, for when the leather top is up the chauffeur cannot see out of the side of the car, but in this landaulet there is a glass in the quarter same as on the limousine, and the top is so constructed that it can be dropped in the usual way. This makes an extremely handsome landaulet that looks light and is useful for an interior drive. Nothing of this kind has been shown before in any show. The body is painted in a beautiful color of maroon, known as the Flandrau maroon, a color made by Flandrau & Co. It is an extremely rich shade, beautiful and durable. The mouldings and upper part of the body are painted black, thus matching the leather top and edged with a brilliant carmine.

The interior is trimmed with a special Parisian goat skin of a rich maroon color, rather an unusual shade and very beautiful. The goat skin is used on the seats and back with an appropriate lace, having the color of the painting and trimming incorporated in it. The roof is trimmed with cloth to match the goat skin; carpets and silk curtains also matching. The seats are roomy and the interior most comfortable in appearance and in use. The front is the rain and snow shield.

The chassis is mounted with four fenders, all the lines being swept or curved so that the running boards fit into the rear and front fenders without making an angular corner. These fenders have outer skirts of metal and inner skirts, both rear and front, protecting the body and the hood.

At the rear there is a compartment which can be utilized for a chauffeur seat, carry packages, luggage, etc.

Victoria (or as known when made as a horse-drawn carriage. Queen Cabriolet). Fitted on a 15-30 Stearns—This is the best shaped Victoria made or shown upon any chassis, for it is not only beautiful in design, but the lines are made to fit into a Stearns in such a way that it does not have the incongruence and peculiar appearance that the one or two Victorias that have been shown. The complete Victoria has been carried out in this car. The rear seat is divided in two cushions; and is trimmed with blue goat skin of medium deep shade, with lace to match and painting and trimming. The Victoria hood has four bows; it is lined with cloth to match the goat skin. These skins are the celebrated El De Baran make of Paris.

An attractive emergency seat fits against the bottom of the front seat and is trimmed with goat skin and lace exactly matching the goat skin and lace covering the heel part of the rear seat. This seat may be removed if not required. The back of this emergency seat is made by covering the rear of what would be known in a carriage as the lazyback with mole skin or highly varnished soft leather padded so that it looks like a painted panel and yet is soft for a back on an emergency seat.

The chauffeur's seat is made exactly like the dicky seat of any horse-drawn carriage; divided in the center, smooth trimmings

and with lazyback trimmed as usual with an extra back running down into the cushions, making a very comfortable seat beside the chauffeur and not detracting from the Victoria body. In addition to the front boards on the front seat, a blue carpet matching rear carpet is fitted, which finishes off the interior of the car nicely.

The chassis is not mounted with fenders or running boards, but have the regular victoria hand forged steps for entrance to the rear and to the front seat to which are attached six hand-forged fenders covered with the finest grain dash leather between which wadding is placed to give it a full appearance and stand wear better and all the wings being stitched entirely by hand, the only method by which a fender may be made impervious to water. These front fenders have leather skirts and the steps have leather skirts and also a leather fender to protect the dress from the rear spring axles. Thus the whole appearance of the car is of a Victoria with all the lines harmonizing, nothing incongruous or clashing.

The coloring of the body and chassis is of a rich deep Flandrau blue, and the stripes in a brilliant shade of blue.

FRENCH IDEAS.

The production of automobiles of extremely low first cost which may be adapted to displace the horse in even the humblest forms of transportation, continues to engage the attention of European designers. Francis Ernault proposes a new type of vehicle spring which might be applied to such automobiles at first,

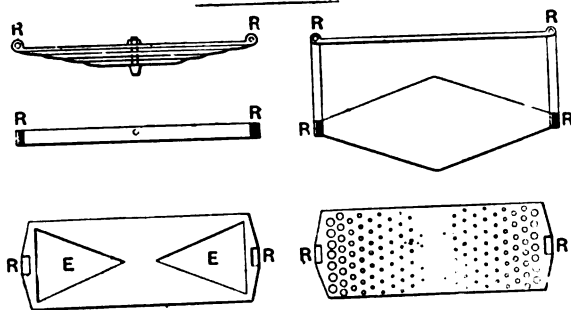

though he believes its field of application should eventually prove much wider. He wants to use a spring plate of uniform thickness and varying in width instead of the multiple leaf spring of uniform width and varying thickness. The illustration (Fig. 1) shows the comparative dimensions of an ordinary vehicle spring and of the one-leaf spring intended to take its place, and also two other shapes in which triangular cut-outs or a series of perforations permit the sides of the spring to remain parallel. With regard to simplicity and cost of making, Ernault mentions that apart from the eyes, which are alike for both types, the one-leaf spring may be stamped in a single operation, while the ordinary

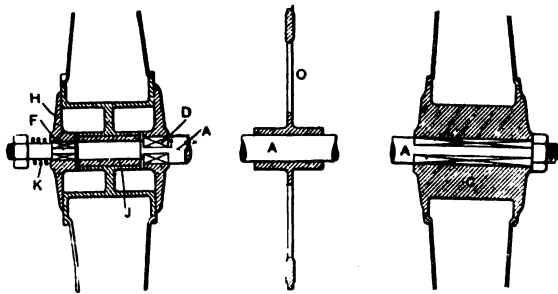

spring requires many. When cut to length each of the leaves must be arched, one differently from another; they must be perforated for the assembling bolt, the ends must be rounded, they must be beveled, slotted and pinned or spurred, the leaves must be placed and adjusted with care, lubricated and mounted. As to wear, the single leaf escapes the friction of one leaf upon another and therefore demands no care, while the multiple spring

must be taken down occasionally, cleaned and greased. The single leaf works always in the same manner, while the multiple one creaks and becomes hard, when not greased, and weaker from wear. Defects in the temper or curve of any one leaf may cause it to break.—La Technique Automobile et Aerienne.

Evidently with a view to very cheap construction, Leon Charpoux offers a substitute for the differential gear in the arrangement shown in the sketch (Fig. 2). The axle A is supposed to be driven from the sprocket wheel O and is joined rigidly with the hub C of one of the driving wheels by means of a squared end portion and a nut. The other end has two short squared portions D and F, between which lies a cylindrical portion operating as a bearing member for the other driving wheel, the bushing J being interposed. Two friction plates G and H are mounted upon the squared portions D and F and are pressed against the adjacent surfaces of the wheel hub by spring K, secured by a nut. Leather washers between plates G and H and the hub surfaces are kept lubricated from a mass of consistent grease filling the hollow spaces in the hub. The tension of the spring K is adjusted to produce a friction coupling which will hold tight for straight driving, but will yield more or less at turns (and grades) permitting the wheel to rotate faster or slower than the other.—La France Automobile.

FLEXIBILITY OF MOTORS.

Rating an internal combustion motor such as is used in automobile work is a simple matter for popular consumption, but coming down to realities the pathway is beset with difficulties. If horsepower alone is taken in the rating of a motor, it may be that the power claimed for a given motor will be at some speed that cannot be utilized in practice. As an illustration, let us assume that a 4x4 inch bore and stroke motor may be so designed that it will deliver 25.6 horsepower at a piston speed of 1,000 feet per minute. Now, this piston speed means that the motor speed will be 1,515+ revolutions per minute. In order, however, to be able to utilize the motor at this speed, if the transmission gear is so designed that the drive will be direct on high gear, the bevel gear set will have to be in the ratio of 1,515÷374=4.05+. This is a possibility in practice; it is about the limit under present conditions of construction unless resort is had to worm drives; they are now used to quite some extent abroad; the reason is obvious. But supposing the same motor to be rated at 38.2 horsepower, and to obtain this power it is necessary to so design the motor that it will speed up to 2,572 revolutions per minute in the delivery of this power. The bevel-gear set would then have to be designed on the basis of a little over 6 to 1. What does this mean structurally? Supposing that the bevel pinion be given 15 teeth, 5 diametrical pitch; for a ratio of 6 to 1 it would be necessary to put 90 teeth in the gear. Such a gear would have a ditch diameter of 18 inches. It will be unnecessary to continue this part of the discussion, says The Automobile; there is no room in a live rear axle housing for a gear of such large dimensions. But if the gear cannot be used, it also happens that the motor cannot be employed at the power of its rating. This being true, the motor might just as well live under a more modest name; it becomes a 25.6 horsepower motor instead of a 32.8 horsepower motor to all intents and purposes.

M. A. M. ADMITS NINE NEW MEMBERS.

At the meeting of the board of directors of the Motor and Accessory Manufacturers January 12 there were admitted nine new members, making a total membership of 230. The newcomers are: Amesbury Metal Body Co., Amesbury, Mass., Armour Curled Hair Works, Chicago, Ill.; Atlantic Refining Co., Cleveland, O.; Booth Demountable Rim Co., Cleveland, O.; Dean Electric Co., Elyria, Ill.; Dorian Demountable Rim Co., New York City; Hayes Wheel Co., Jackson, Mich.; Medina Stamping & Metal Machine Co., Medina, N. Y.; Union Drawn Steel Co., New York City.

MOTOR TRUCKS IN CHICAGO.

Because the National Commercial Vehicle Show in Chicago was held the week following the tenth annual automobile exhibition and in the same buildings, the display of power vehicles for all sorts of business purposes had the same elaborate setting as the pleasure car exhibits.

The main features of the decoration of the Coliseum were four fountains extending down the center aisle of the main floor, illuminated vases mounted ten feet in the air on ornamental bases extending to right and left of the fountains, clusters of 12-inch and 16-inch incandescent globes atop of ornamental posts rising between the vases, and an ornate ceiling simulating stained glass.

Some novel and interesting types of machines never previously displayed at a public exhibition were seen among the commercial motor vehicles. One of these is a combination farm tractor and truck of three tons load capacity.

This machine is used for all sorts of work on the farm. It hauls gang glows, pulls two ordinary 14-foot harrows, hauls threshing machines into the field and then drives the belt to operate them. It furnishes power to run a circular saw to cut fire wood, drags a road scraper, hauls loads of three and a half tons of grain, hay or other farm products to the railroad and carries back loads of machinery, household goods or supplies from the stores. The tractor-truck is driven by a 36-horsepower gasoline engine. It is provided with a pulley at the front from which a belt can be run to operate all kinds of heavy farm machines, thus making the truck a portable power plant.

Another exhibit of great interest was a ten ton truck with an 18-foot platform—one of the largest motor trucks that is built as a regular model. In contrast with the monster trucks were small general utility wagons that can be converted in a few minutes from work vehicles to pleasure cars for two or four passengers. It is a 2-cylinder opposed horizontal engine, air-cooled, and hung underneath the body at three suspension points from the main frame. The body, which is an open bed, is 80 inches long in the clear under the seats and is 31 inches wide. At the front end is a hood which is used for storage or small luggage.

One new truck is so new that specifications are not yet available for publication, but photographs show that while the design follows conventional practice to a considerable extent, an unusual characteristic is a worm drive to the rear axle and the consequent elimination of the usual side chains. The propeller shaft terminates in a quick-pitch worm screw that engages with a corresponding worm wheel bolted to the differential.

Metal chain cases that keep the side drive chains clean and thus reduce chain wear, breakage and transmission loss to the minimum, are a notable feature of the new trucks just brought out by another company whose pleasure cars are in the top-notch class. These trucks are also equipped with permanent tops that can quickly be made into closed cabs for the drivers in bad weather. There is a glass screen or wind-shield that rises from the dash to the front of the roof. Storm curtains at the sides and back. The back curtain falls from the top of the cab to the back of the seat. These trucks are made in two sizes—three tons and five tons capacity—but are both driven by 32 horsepower engines of the four cylinder type. The trucks have a length over all of 19½ feet and load platforms measuring 12 by 6 feet. Following conventional practice in trucks of this type, the front wheels are fitted with single solid rubber tires 36 by 4 inches and the rear wheels with dual tires 40 by 4 inches.

Still a third well known pleasure car company sprung a surprise at the show this winter in the form of a truck of three to five tons capacity. It, too, has been severely tested and did splendid work in Cleveland during the holiday rush in December. An unusual feature of the construction, which in general follows prevailing practice, is the placing of the 34 horsepower four-cylinder motor and all the transmission system on a subframe which is suspended from the main frame by semi-elliptic springs in front and by a pivoted connection at the rear. This serves the two-fold

purpose of preventing any twisting of the main frame occasioned by inequalities of the road being communicated to the operating mechanism and throwing it out of alignment and also of cushioning the engine against all road shocks and vibrations.

The Chicago show was remarkable for the number of delivery wagons and light trucks on exhibition. They have load capacities ranging from 1,200 pounds to one ton and vary greatly in design and construction, some being driven by four-cylinder vertical water-cooled engines and others by two-cylinder horizontal air-cooled motors.

One of the novelties was an electric hearse which is in the regular service of a Chicago undertaker. This is believed to be the only electric hearse that has been built. Incidentally, it may be remarked, several of the exhibitors of electric wagons will show them equipped with the new nickel-iron alkaline batteries or built to use this battery as well as the standard lead batteries.

Several manufacturers displayed models of motor fire apparatus, also police patrol wagons and motor ambulances, both gasoline and electric. Motor trucks with dumping bodies that are operated with power supplied by the motor proved centers of interest. The ease and quickness which a load of three to seven tons of stuff can be dumped on the ground represents real dollars to contractors.

One of the most unique forms in which the commercial motor vehicle appears and one that never before has been seen in the West, is an industrial truck designed especially for use in factories and warehouses and at railroad stations and steamship docks for hauling trunks and freight. These are electrically driven and are made in several styles and sizes, some running on three and others on four wheels. Their flat platforms are only two feet above the floor and their maximum speed is four miles an hour. But they can move all day at this rate on a single charge, carrying from two to four tons. They are made narrow so they can run up and down the aisles in a factory and are steered by front and rear wheels so they can turn very short corners. They move equally well in either direction and can be operated from either end. They can be taken on elevators to any floor in a factory and can be run from one factory to another in the yards of a big manufacturing plant.

PERSONAL.

W. B. Brinton, former president of the National Association of Vehicle and Implement Dealers, is the only avowed candidate for mayor under the new form of government (commission idea) in Dixon, Ill.

Announcement has been made at the offices of the American Automobile Manufacturing Company, Louisville, Ky., that a contract had been closed with C. D. Norris, now superintendent of the Studebaker Automobile Company, of South Bend, Ind., to take the position of superintendent of the company's plant in New Albany.

Herbert Lorgendyke, who managed the recent auto show in Grand Central Palace, has been chosen as general manager of the newly incorporated Automobile Manufacturer's Association of America. To accept the position Mr. Lorgendyke agreed to resign from the Journal Company, of Troy, and devote his entire attention to the interests of the independent motor car makers represented in the new association. The following officers were selected to conduct the organization: President, Col. Theodore Campbell, of the Imperial Auto Company, Jackson, Mich.; first vice-president, William S. Jones, of the Otto Gas Engine Company, Philadelphia, Pa.; second vice-president, Prof. Warren S. Johnson of the Johnson Service Corporation, Milwaukee, Wis.; treasurer, William J. Mills, of the H. H. Babcock Company, Wauertown, N. Y.; assistant treasurer, Carl F. Johnson, of the Johnson Service Corporation, New York City; C. W. Kelsey, of the C. W. Kelsey Manufacturing Company, Hartford, Conn.; assistant secretary, J. L. Robinson, New York City.

FRONT WHEEL BRAKE.

The next important move will be the equipment of the autocar with brakes on the four wheels. There is illustrated one method of applying the brakes to the front wheels. It is an English invention.

To permit the brake elements to swivel with the wheel and provide a simple means of operating them, the brake operating lever A is extended so as to pass over the axis of the steering pivot

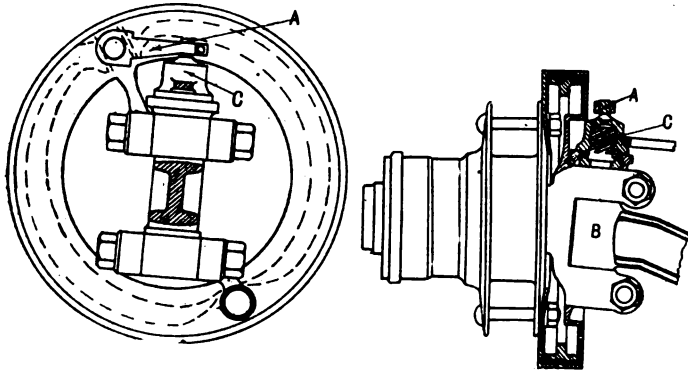

B. At a point immediately above the axis it is provided with an adjustable bearing portion resting upon a rotatable cap C. This cap is provided with an operating lever connected to the brake lever or pedal, and is adapted to rotate upon a screwed head of the steering pivot B. The screw connection is a quick one, so that for small movement of the operating lever the cap rises a considerable amount, turning the actuating lever A about its pivot, and spreading the brake blocks. It will be seen that the construction does not in any way interfere with the swiveling of the wheel for steering purposes.

STANDARDIZATION IS STARTED.

The work of standardization to which the Society of Automobile Engineers has committed itself now has been fairly inaugurated, the first of the many sub-committees that are engaged in the task having met and assumed its allotted burden.

The current practice in frames for motor cars is marked by little uniformity in sizes and proportions of the sections, although it is apparent that a smaller number of sections would be sufficient and reduce the tool cost.

It was the sense of the Cleveland meeting that the frame as an element of automobile design should receive more attention in the initial stages of laying out a car model, with relation to the disposition of other elements of the machine. The committee in its report will recommend the quality of steel to be used in frames. This is one of the two divisions of the subject of standard frame sections. The other division is the design of frames generally. The matter of design will be subdivided somewhat as follows:

Side bars—1. Main section; including (a) thickness of metal, (b) thickness relative to depth of section, (c) width of flange.

2. Standard front ends, of which there are said to be a thousand current designs of frame front ends.

3. Standard taper for rear end.

4. Uniform radii of curves and depth of drop for drop frames and double-drop frames.

5. Main width of frame at rear end.

6. Offset of side rail to produce front end width. Proportion of length of offset to amount of offset.

Cross members—7. These are straight and curved. As to the former, matters to be considered are standard radius and length for integral gussets, which should preferably, as a matter of cost of production, be on the cross bars instead of on the side rails; as to the latter (curved cross bars), standard radii and amount of drop of front member. And in general harmony of design with relation to strength and weight of side bars.

Sub-frames—8. Dividing into (a) amount of drop, (b) width between engine bars and (c) taper of engine bars.

Diagrams will be produced showing ways of economizing on material to arrive at minimum waste without interfering with merit of design, amount and place of material that should remain after holes are drilled for assembling cars; preferred path for holes; advisable lips and lugs on cross members and outside fittings, spacing of rivets.

NEW TWO-STROKE ENGINE.

The most recent example of improvement along the line of simplicity is an English invention, which we illustrate.

This engine employs a tandem piston and cylinder, the lower cylinder portion drawing in carburetted mixture through the inlet valve, and pumping it through another valve into the top of the working cylinder, exhaust taking place through a port at the bottom of the piston stroke as usual. The feature of the invention consists in the employment of the crank chamber for the compression of air used for scavenging only. It will be noticed that passing through the pistons is a tube which is formed with ports

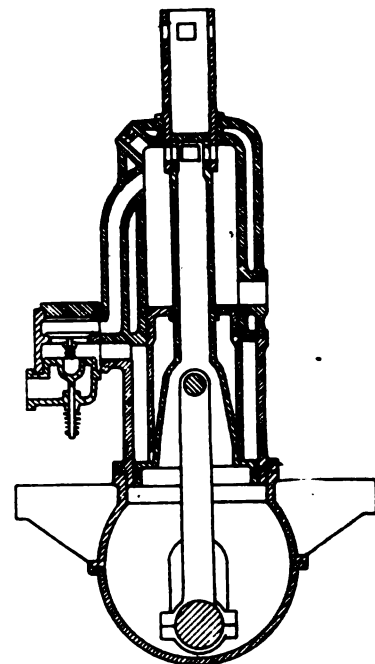

communicating with similar ports in each end of the sleeve. At the top of the stroke of the piston cool air is admitted through the ports in the tube, allowing the crank chamber to be filled. On the down stroke this is compressed until the position illustrated is reached, when the ports register with each other, and permit the air compressed in the crank case to pass through into the cylinder, and blow the products of combustion out through the exhaust port. In this manner one of the chief difficulties with two-stroke engines is said to be overcome.

LOWER METAL PRICES LOOKED FOR.

In its review of the metal market, The Iron Age, which is considered authority, says:

The expectation of lower prices is to-day the dominating influence in iron and steel markets. The meetings held by the manufacturers in various lines appear to have increased the confidence of buyers that a lower level will soon be reached, either by cooperation or through an open market as in February, 1909. As a result business has fallen off sharply, and has brought further restriction in output of blast furnaces, steel works and rolling mills. The industry will go into the new year at a pace much below that at the opening of the month.

The pig iron market, which has been free from any effort by producers to co-operate, is nearer to a standstill than finished materials. Southern iron is freely offered at \$11, at furnace, for No. 2 for the first half of 1911, but foundry buyers seem even more disposed to wait than before.

TUBULAR FRAMES.

This type has practically dropped out of existence, mainly because of the difficulty of making satisfactory joints, and of attaching the various brackets in a simple manner and at a reasonably low cost—a difficulty which in these days of electric and acetylene welding might now be overcome. As a set-off to any extra cost of manufacture, it must be remembered that a tubular section is very rigid and affords the most effective distribution of metal for resisting torsional and compressive stresses, while in tension this section is, of course, as good as any other. It is not the best section to resist a bending stress in any one direction, but it should not be impossible to design a tubular frame in which the side members were satisfactorily stiffened without the use of an undue amount of material, such as by the use of double tubes, or of truss rods.

Considering, then, how impossible it is to determine the direction and intensity of most of the stresses in a frame, the tubular member seems to offer advantages not possessed by the more usual channel and H sections, which while excellent for resisting a bending stress, in a given plane, are much less effective under compression than a tube, and are notoriously weak under torsion.

The general shape and construction of the frame depends to a large extent on the type of suspension adopted.

ANOTHER VEHICLE BODY FACTORY.

In no line of accessories connected with the carriage industry has there been a greater increase in factory equipments than in carriage and automobile body construction. Several of the largest concerns have recently made additions, and in Cincinnati a new concern has established itself in this line of manufactures, namely The Wiggers Furniture Company, located at 1417 to 1421 Plum street, Cincinnati, Ohio.

By new industry we do not mean that the concern is entirely

largest factories in the country. The accompanying cut gives but a scant idea of the capacity of this concern, as there are several additional buildings not shown in this illustration.

They have purchased all the latest machinery known for the manufacture of carriage and automobile bodies, seats and special body bending, and have skilled workmen, and we predict that within the next few years the Wiggers Furniture Co. will be among the largest manufacturers in this line in the United States.

The company is officered as follows: A. H. Wiggers, president and manager; H. H. Wiggers, treasurer and secretary, and E. S. Wiggers, vice-president.

We would suggest to the trade that they write to the Wiggers Furniture Co. for prices on any seat construction, feeling confident in this suggestion that the prices will be most interesting. Mr. Fred Hessdorfer will call on the trade and we bespeak for him a successful career.

KNIGHT MOTOR REARING ITS HEAD.

For some time to come it is believed that automobile engineers will be engaged in valve work. The Knight motor and its success abroad has caused a lot of deep thinking. Makers of automobiles, who desire to keep abreast of the times, are not slow to recognize the fact that there is more than a mere question of merit to be considered. If the Knight motor works fairly well, and it comes over here in foreign makes of automobiles, there will be an invasion that will not be kept out by a mere tariff wall. One of the good characteristics of the American may be summed up when it said that he will go after, and get, what he desires. and if he puts in a brief for a Knight motor he will have it by the very next steamer.

That there is a good chance for a number of marked failures in this quest for a substitute for the poppet valve is proven by the failures that already show up on both sides of the trail. Poppet valves, if they are properly designed, are not to be sneezed

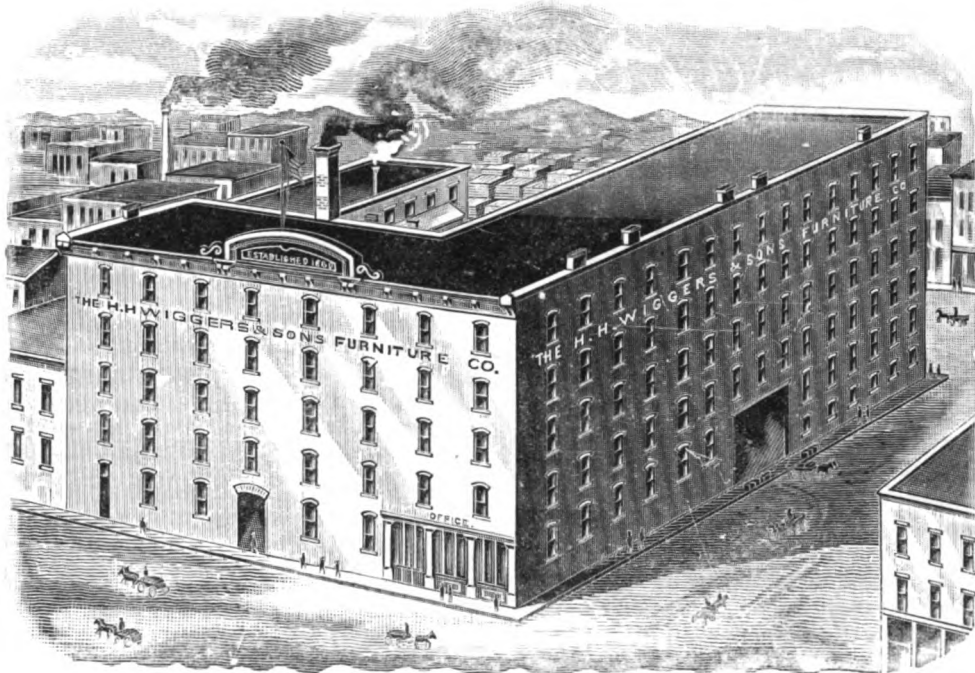

Partial View of Plant of Wiggers Furniture Co.

new in the line of wood products. The Wiggers Furniture Company was established in 1865 by Mr. H. H. Wiggers, father of the present secretary and treasurer of the concern. The original product of the institution was furniture and wood mantels.

Within the past six months they have entered into the manufacture of carriage wood work and have succeeded beyond their expectations in placing their bodies and seats in some of the

at. The trouble is designers do not compare notes with each other; they are not in a position to take advantage of co-operation, but the Knight motor, and the scheme that is being worked abroad, is on the basis of co-operation. The British Daimler project is being supervised by Charles Y. Knight. Then, the Panhard (Knight) motor, in France, has all the benefit of Daimler experience. Cross to Belgium; what is the result of observa-

tion? The Minerva (Knight) undertaking is getting the benefit of the Knight experience in England. Likewise in Germany the Mercedes (Knight) work is under the light of co-operation, and so on in Austria, and in Italy.

But how about America? What are the measures for co-operation here? There are none. We are so much engrossed in our efforts to best each other that we have no time to compare notes? In the meantime, are we getting along? Are we as successful as our efforts would lead us to believe that we ought to be? The strange way that we have for proving the strength of our brotherly love is taken advantage of abroad and the result is that we read in the technical papers of the divers ways that others employ to combine knowledge and cash it in over our heads.—P. J. M., in Automobile.

SHAKESPEARE AND WHEELS.

Shakespeare's use of the technical term for a peculiar form of joint in carpentry (Othello, ii.), the "mortise," has been already put before the reader, but allusion to the same firm interlocking of two parts is beautifully and accurately made by Rosencrantz in Hamlet, iii, 3, when he says of monarchy:

'Tis a massy wheel

Fixed on the summit of the highest mount,
To whose huge spokes ten thousand lesser things
Are mortised and adjoined.

In the same play also we have an equally excellent use of the technical phrases of the wheelwright, when the first player exclaims:

Out, out, thou strumpet, Fortune! all yon gods
In general synod take away her power—
Break all the spokes and felloes from her wheel,
And bowl the round nave down the hill of heaven
As low as to the fiends. (ii. 2.)

Of the rotundity of Falstaff, Prince Henry gives us a goodly notion—

Would not this nave of a wheel have his ears cut off?
2 Hen. iv., 4.

GRAMM ON THE OUTLOOK.

Mr. B. A. Gramm, the energetic vice-president of the company bearing his name, has time, occasionally, to look over the field of business motor cars, and write his conclusions.

He finds the prospects for this year exceptionally bright, and thinks the only trouble, if trouble there be, will be the difficulty of supplying the demand. He states some conclusions in a recent communication, which we reprint in part:

"That the outlook in the motor truck industry for the coming year will be far ahead of anything thought of two years back, will certainly not be disputed by any thinking man. Ten years of the ordinary business progress, to the motor truck industry is now but a year. If we stopped to consider that statistics show us that there are nine horses used for commercial purposes to every one horse used for pleasure, and then should these same statistics apply to the motor truck and the pleasure car, we can just begin to get some idea of the business that is confronting us in the future.

"That the entire business world has awakened to the absolute need of motor trucks there certainly can be no dispute. To know the varied uses means to take a trip through every industry, and into almost every city of any size. If one will stop to consider that 54,000,000 tons of freight were handled on New York streets the past year, and this volume will increase each year, and yet the streets remain the same size, you will begin to get some idea of what motor trucks can accomplish.

"Horses, to-day, in New York City, if placed in teams, one behind the other, will cover 220 miles of streets. When you think of all the space that they occupy, and how much faster, and more satisfactory, motor trucks could handle the same business, with-

out the unsanitary annoyances, it is another reason for realizing the possibilities of 1911 with motor trucks.

"The trouble in the past has been that the business man will hesitate to make a small loan, wanting ample security and good interest, will then turn around and turn an investment of from \$2,000 to \$5,000 in a motor truck over to some irresponsible driver, who is unable to give him any security whatsoever for taking care of his property, and stranger than this is the fact that he will, invariably take the man's part against the truck manufacturer, and will allow the truck to carry loads far beyond what he purchases it to carry; thus using something that he did not pay for.

"However, all these points are rapidly regulating themselves, so that we can look forward to the year 1911 as the opening of one of the greatest industries in the motor line that the world has even seen."

IMPORTANT WAGON DEAL.

The Lansing Wagon Works, of Lansing, Mich., and the Rock Island Plow Company, of Rock Island, Ill., have concluded an arrangement whereby the Western Rock Island Company, of Omaha, and the Rock Island Implement Company, of Kansas City, will handle the Lansing farm wagons in the wholesale trade during the coming year.

Wants

Help and situation wanted advertisements, one cent a word; all other advertisements in this department, 5 cents a word. Initials and figures count as words. Minimum price, 30 cents for each advertisement.

POSITION WANTED.

Wanted—Carriage and Wagon Painter. A No. 1 letter striper and finisher, capable of foremanship, desires position. Fine business wagon and truck work preferred. Address W. D. L. care The Hub, 24 Murray St., New York.

HELP WANTED.

Wanted—Man to take charge of vehicle body factory as superintendent. Send names of former employers. Good position to right man. Address M. C., 92 care The Hub, 24 Murray St., New York City.

Wanted—Foreman for woodwork department, a man capable of making pencil sketches and scale drawings, working draughts of limousine and Berlin bodies, and all kinds of automobile work. State experience and where last employed, also state wages expected. L. Glesenkamp Sons & Co., 320 Penn Ave., Pittsburg, Pa.

Wanted—Salesman to sell our line of buggies and cutters on commission. Address F. W. M., 93, care The Hub, 24 Murray St., New York.

Wanted—Carriage trimmer for light work. Steady job. Address Clarence Randall, Newtown, Pa.

FOR SALE.

For Sale—Wagon shop; can be used as automobile repair shop. Building, machinery and tools; has electric and gasoline engine powers. Established 33 years in Chicago. Must be sold on account of sickness. Address F. S., care John Weiss, 739 N. Wood St., near Chicago Ave., Chicago, Ill.

For Sale—Carriage and blacksmith business in town of 15,000 population. New two story, up-to-date, concrete block shop, 30x50, all the latest machinery, electric power, trip hammer, planer band saw, lathes, drill, press, etc. Two lots, 25x125, and four room house. Good business, am selling on account of accident which renders me unfit for work. Address R. J., care The Hub, 24 Murray Street, New York City.

BUSINESS OPPORTUNITY.

Business Opportunity—A sound Danish automobile factory seeks connection with a first class automobile factory capable of quick delivery. Any firms interested are requested to send their catalogues to Ingvar Tander, Aahuss, Aarhus, Denmark.

PATENTS.

Patents—H. W. T. Jenner, patent attorney and mechanical expert, 608 F St., Washington, D. C. Established 1883. I make a free examination and report if a patent can be had and exactly what it will cost. Send for circular.

The TIMKEN ROLLER BEARING CO.

MAKERS OF TIMKEN ROLLER BEARING AXLES
for **WAGONS** and **CARRIAGES**



Canton, Ohio

A Set of
TIMKEN AXLES
will save your
CUSTOMERS
these two horses

This statement is based on the experience of thousands of users.

New Catalog and Price List upon application.

THE TIMKEN ROLLER BEARING CO.,
CANTON, OHIO,

BRANCHES- 10 E. 31 st Street, New York.
429 Wabash Avenue, Chicago.

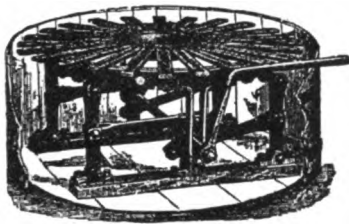

The Bokop Tire Setter and Cooler
Is the Best and Only Machine that has stood the test during the last 12 years on all classes of work, and is the Only Machine built with the Indestructible Wrought Iron Face Plate.
Over 1,000 are in successful operation, repairs on which have not exceeded \$6.00 in the last 12 years. For prices, references and descriptive circulars, address
BOKOP, WEBB & PALM,
Defiance, Ohio

E. SCOTT PAYNE CO.
OF BALTIMORE CITY
**CARRIAGE AND AUTOMOBILE
HARDWARE**
362 and 364 North Gay Street,
BALTIMORE, MD.

CARRIAGE SPRINGS OF EVERY STYLE AND PAT- TERN TO ORDER

Also Curtain Rollers and Concealed Hinges
EXCLUSIVELY FIRST-CLASS WORK
THE BEST THAT CAN BE MADE

SPRING PERCH CO.
BRIDGEPORT, CONN.

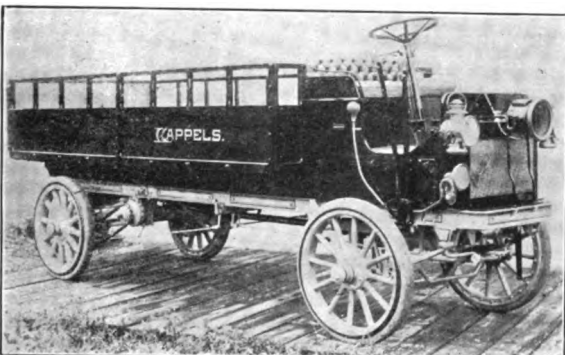

The Grammm is made in 1-ton, 2-ton, 3-ton and 5-ton models.

The GRAMM Was a Success Before Other Commercial Cars Came Into Existence

Ask any well posted man to tell you what commercial cars were prominent when the really great American pleasure cars were first making history.
"Well," he will say, "there was the Grammm."
And there he will stop. He knows the Grammm because a decade ago B. A. Grammm had marked out the way for other successful trucks to follow. The Grammm was a notable, practical achievement long before competing commercial cars came into being. Those years of extraordinary experience are the Grammm's greatest asset; no truck buyer can close his

eyes to the fact that other trucks must pass slowly through the same trying period of development. Wherever the Grammm has entered into a contest with other trucks, the value of that long experience in truck building was made clear. The Grammm has not only made repeated perfect road and technical scores when handicapped with overloads, but **IT WAS ALWAYS READY TO REPEAT ITS SUPERB PERFORMANCE.**
In addition to the Grammm's efficiency, its marvelous records in economy tests offer the most powerful appeal possible to the shrewd truck buyer.

You must inevitably judge all other motor trucks by the Grammm.

THE GRAMM MOTOR CAR CO.,

107 South Lima Street, Lima, Ohio, U. S. A.

New York Headquarters: CROSS-MAGILL MOTOR TRUCK CO., 30 Church St., New York City.

Let us send you our monthly "Grammm."



THE BALL MULTI-SPARK PLUG
 "The Plug That's So Different"
 The central electrode has a **SMALL BALL** on the end for the terminal, giving $\frac{3}{4}$ -inch sparking surface; it also acts as an electrical condenser, raising the voltage, increasing the heat and flame, thereby enabling the use of a poorer mixture to obtain the same power. It does not require cleaning often, the hot spark consuming the carbon deposit; will stand more oil than any other plug, and is carefully and substantially built.

THE BALL MULTI-SPARK PLUG CO.
 917 Hennepin Ave. MINNEAPOLIS, MINN.



A. OCHSNER & SONS CO.
 NEW HAVEN, CONN.

Auto and Carriage
 Locks, Hinges, Etc.

VEHICLE AND AUTO TOP HARDWARE
 Rails, Joints, Bow Sockets for the
WHOLESALE TRADE ONLY
 Write
INDIANA FORGING COMPANY.
 Mention Hub. INDIANAPOLIS, IND.

Carriage Mechanics
 Desiring to improve their present
 Condition should attend the

TECHNICAL SCHOOL
 FOR
Carriage Draftsmen and Mechanics
 SUPPORTED BY THE
Carriage Builders' National Ass'n.

The object of the School is to teach men to design vehicles and make working drawings, and to otherwise facilitate their work in the shop. Only those men employed in carriage or automobile building or their accessory trades are admitted to its privileges.

The classes are conducted in three divisions, viz.: Corresponding, Day, and Evening. The former is open during the entire year, while the day and evening classes are in session only from October 1st to April 1st.
 The tuition is moderate.

For prospectus and full particulars, write to the instructor,
ANDREW F. JOHNSON,
 18 West Forty-fourth St.,
NEW YORK CITY.

INDEX TO ADVERTISEMENTS.

| | |
|------------------------------------------------|-----------|
| Aden Mfg. Co. | 17 |
| American Ball Bearing Co., The | 3 |
| American Roller Bearing Fifth Wheel Co. | 18 |
| Ault & Wiborg Co., The | 3 |
| Ball Multi-Spark Plug Co. | 12 |
| Bailey & Co., Inc., S. R. | 18 |
| Bokop, Webb & Palm | 11 |
| Boub Wheel Co., H., The | 18 |
| Columbus Bolt Works | 4th cover |
| Consolidated Rubber Tire Co. | 2nd cover |
| Crane & MacMahon | 2nd cover |
| Devoe, F. W., & Reynolds Co., C. T. | 3rd cover |
| Eberly & Orris Mfg. Co. | 3rd cover |
| Eccles Co., Richard | 17 |
| Enterprise Foundry, The | 13 |
| Gifford & Son, John A. | 13 |
| Goodrich Co., B. F., The | 5 |
| Goshen Eyelet Co. | 14 |
| Gramm Motor Car Co., The | 11 |
| Hoopes Bro. & Darlington, Inc. | 2nd cover |
| Indiana Forging Co. | 12 |
| Jones & Co., Phineas | 4-6 |
| Keystone Paint & Filler Co. | 4 |
| Kilvington, S. W. | 18 |
| Masury & Son, John W. | 2 |
| Mayo Radiator Co. | 4th cover |
| McKinnon Dash Co. | 4th cover |
| Mercer, Geo. J. | 18 |
| Moller & Schuman Co. | 6 |
| Murphy Varnish Co. | 4 |
| Nelson Co., A. T. A. | 2 |
| New Wapakoneta Wheel Co., The | 13 |
| Ochsner & Sons Co., A. | 12 |
| Payne Co., E. Scott | 11 |
| Porter, H. K. | 17 |
| Reilly, John, Inc. | 2 |
| Russell, Burdsall & Ward Bolt and Nut Co. | 3rd cover |
| Schubert Bros. Gear Co. | 17 |
| Spring Perch Co. | 11 |
| Standard Automatic Mfg. Co. | 1 |
| Standard Oil Cloth Co. | 18 |
| Standard Wheel Co. | 17 |
| Steel Socket Shaft End Co. | 13 |
| Timken Roller Bearing Co. | 11 |
| Uebelmesser Co., Charles R. | 14 |
| Valentine & Company | 6 |
| West Tire Setter Co. | 6 |
| Wiggers Furniture Co. | 4th cover |
| Wilcox Mfg. Co., D. | 15 |
| Wiley Co., C. A. | 4 |
| Woodman, Joel H. | 14 |

Please mention "The Hub" when you write.

VEHICLE WHEELS OF REAL WORTH

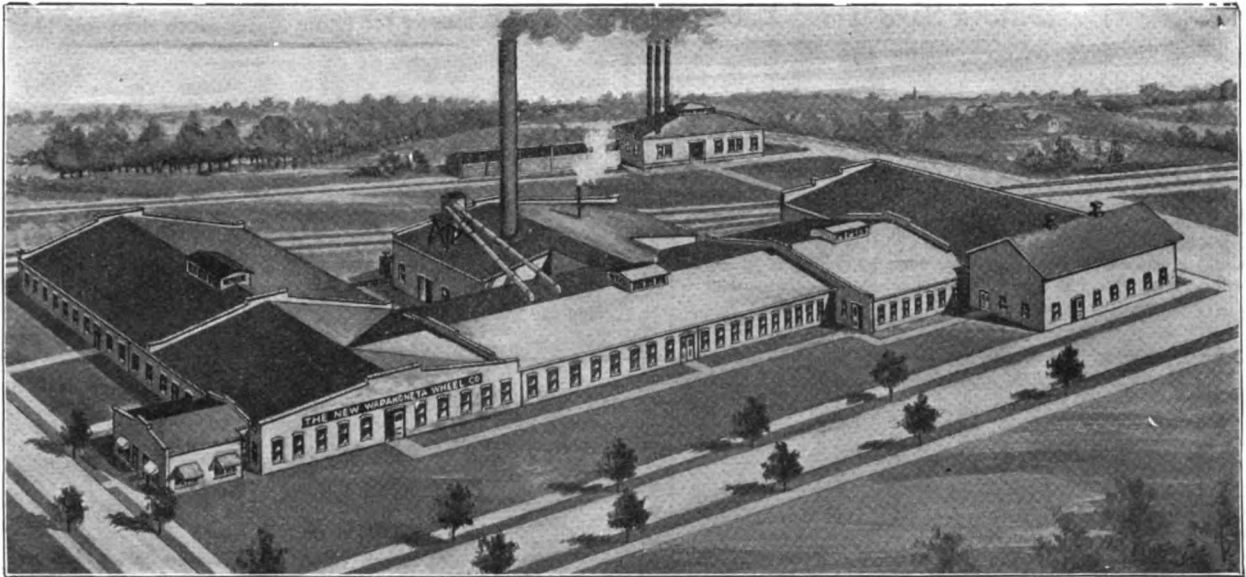

We manufacture Vehicle Wheels of All Kinds; Light and Heavy. Sarven, Warner, Compressed Band and Wood Hub. Send for our Price List.

THE NEW WAPAKONETA WHEEL COMPANY

WAPAKONETA, OHIO

Burlington Rubber Tire Machine



Our big No. 4 is the only machine made that will apply all kinds of solid and cushion rubber tires both internal and outside wires and close the joint on the same machine. One man can operate the machine easily without help. Put an end to your troubles in applying tires by investing in this machine. Write for descriptive circulars and price.

THE ENTERPRISE FOUNDRY

HARVEY, ILL., U. S. A.



Splice Joint Shaft and Pole Ends Give Perfect Satisfaction

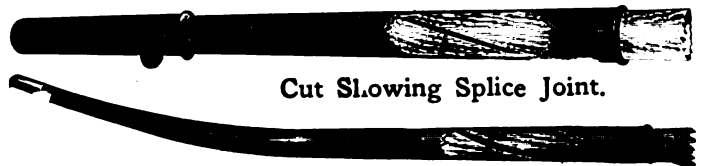

Cut Slowing Splice Joint.

THE SPLICE JOINT where the woods meet adds great strength, guarantees them against breaking where repaired, and prevents working loose and rattling. No shaft end without this construction can possibly give reliable service. No other shaft end than the Splice Joint can have these advantages, as we are the original manufacturers, and these features are fully covered by our patents. Insist on having the original Double Tube Splice Joint Steel Socket Shaft Ends and you get the best.

Handled by All Leading Jobbers.

STEEL SOCKET SHAFT END CO. CLEVELAND, O.

Please mention "The Hub" when you write.



Painters and Decorators Save Time, Labor and Money, using the

Uebelmesser Striping and Stencil Wheel

With this simple, clean and rapid-action tool the most ordinary decorator can do the finest striping and stencil work and produce a bigger day's work with less labor than by the old fashioned method. Complete directions are furnished with each tool. They are as simple as the tool itself.

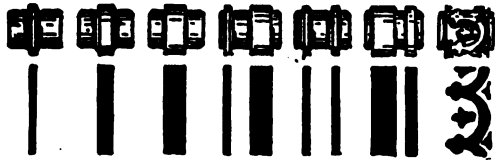

Just a few of the many designs that can be produced with the Uebelmesser Painters' and Decorators' Tool. (The designs shown above are reduced in size)

Complete Outfit consisting of Machine, 10 Plain and 10 Ornamental Wheels, only... **\$5.50**
LIBERAL DISCOUNT TO THE TRADE

Manufactured by
Charles R. Uebelmesser Company
Bayside, New York, N. Y.

Advertisements Classified

The following list includes advertisers in THE HUB. Each advertiser is entitled to name under one heady only. An extra charge for name under more than one heading.

- Axles**
 - American Ball Bearing Co., Cleveland, Ohio.
 - Keagy & Lear Machine Co., Coshocton, Ohio.
 - Timken Roller Bearing Co., Canton, Ohio.
- Automobile Radiators**
 - Mayo Radiator Co., New Haven, Conn.
- Bodies, Seats, Etc.**
 - Kilvington, S. W., Wilmington, Del.
 - Wiggers Furniture Co., The, Cincinnati, Ohio.
 - Woodman, Joel H., Hoboken, New Jersey.
- Bolts and Nuts**
 - Columbus Bolt Works, Columbus, Ohio.
 - Russell, Burdall & Ward Bolt and Nut Co., Port Chester, N. Y.
- Carriage Forgings.**
 - Columbus Bolt Works, Columbus, Ohio.
 - Eccles Co., Richard, Auburn, N. Y.
 - Indiana Forging Co., Indianapolis, Ind.
- Carriage Hardware.**
 - Gifford & Son, John A., New York.
 - Ochsner & Sons Co., A., New Haven, Conn.
 - Payne Co., E. Scott, Baltimore, Md.
- Carriage Goods**
 - Gifford & Son, John A., New York.
 - Higgin Mfg. Co., Newport, Ky.
- Dashes, Fenders, Rails, Etc.**
 - Bennett Mfg. Co., Alden, N.Y.
 - McKinnon Dash Co., Buffalo, N. Y.
- Fifth Wheels**
 - American Roller Bearing Fifth Wheel Co., Brooklyn, N. Y.
 - Wilcox Mfg. Co., D., Mechanicsburg, Pa.
- Finished Vehicles**
 - Balley & Co., Inc., S.R., Amesbury, Mass
- Gear Irons**
 - Wilcox Mfg. Co., D., Mechanicsburg, Pa.
- Gear Woods**
 - Andrew Kimble, Zanesville, O.
- Lamps**
 - Gifford & Son, John A., New York.
- Leather**
 - Nelson, A. T. A., Co., Cincinnati, Ohio.
 - Reilly, John, Inc., Newark, N.J.
- Lubricating Device**
 - Aden Mfg. Co., Dansville, Va.
- Motor Trucks**
 - Gramm Motor Car Co., The Lima, Ohio.
- Machinery and Tools**
 - Bokop, Webb & Palm, Defiance, Ohio.
 - Enterprise Foundry, The, Harvey, Ill.
 - Porter, H. K., Everett, Mass.
 - Standard Automatic Mfg. Co., New York.
 - West Tire Setter Co., Rochester, N. Y.
- Miscellaneous**
 - Goshen Eyelet Co., Goshen, Ind.
 - Standard Oil Cloth Co., New York.
 - Uebelmesser Co., Charles R. Bayside, New York.
- Rubber Tires**
 - Consolidated Rubber Tire Co., New York City.
 - Goodrich Co., B. F., Akron, O.
- Rims**
 - United Rim Co., Akron, Ohio.
- Shaft Couplings and Anti-Rattlers**
 - Eccles Co., Richard, Auburn, N. Y.
- Metal Stamping Co., New York City.**
- Steel Socket Shaft End Co., Cleveland, Ohio.**
- Spark Plugs**
 - Ball Multi-Spark Plug Co., Minneapolis, Minn.
- Springs and Gears.**
 - Keystone Spring Works, Inc., Philadelphia, Pa.
 - Spring Perch Co., Bridgeport, Conn.
- Varnishes, Paints and Japans**
 - The Ault & Wiborg Co., Cincinnati, Ohio.
 - Devoe, F. W., and C. T. Reynolds Co., New York City.
 - Masury & Son, John W., New York and Chicago.
 - Moller & Schumann, Brooklyn, N. Y.
 - Murphy Varnish Co., Newark, N. J.
 - Valentine & Co., New York, Chicago, Boston, Paris.
 - Willey Co., C. A., Hunter's Pt., New York City.
- Wheels**
 - Crane & MacMahon, New York
 - Gifford & Son, John A., New York.
 - Hoopes Bro. & Darlington, West Chester, Pa.
 - Jones & Co., Phineas, Newark, N. J.
 - New Wapakoneta Wheel Co., Wapakoneta, Ohio.
 - Standard Wheel Co., Terre Haute, Ind.
 - Wheel Stock, Bent Wood, Etc. Crane & MacMahon, New York

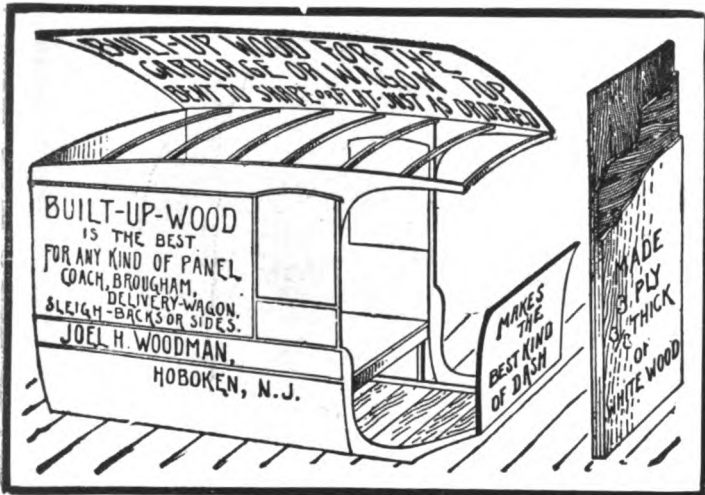

Goshen Eyelet Co.

Manufacturers of

Carriage Top Trimmings

GOSHEN, INDIANA

HEADQUARTERS FOR SPECIAL FINE GEAR IRONS [Dropped Forged] CARRIAGE HARDWARE

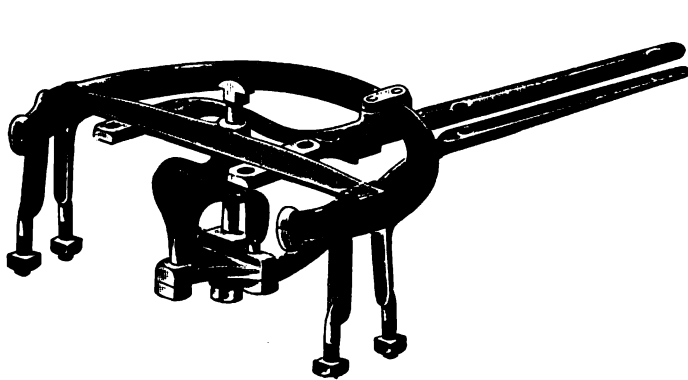

No. 1908—Gear Iron

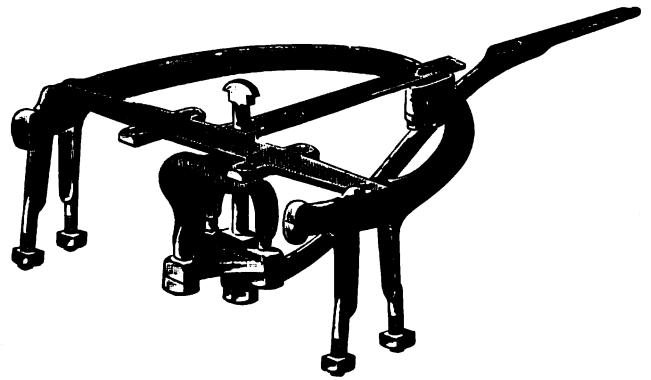

No. 2000—Gear Iron

WILCOX'S Mechanical 3 Prong King Bolt

Double Locked in Head Block Plate and King Bolt Yoke. No Strain on Bolt. No Turn on Nut. Guaranteed.

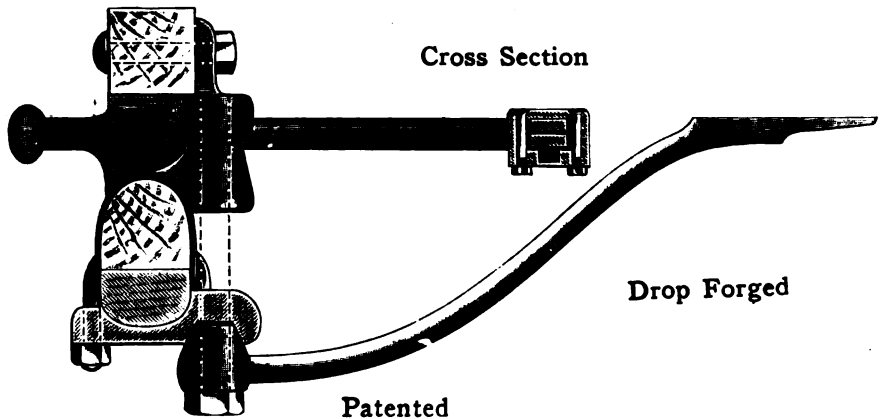

Cross Section

Drop Forged

Patented

S
U
R
E
S
A
F
E

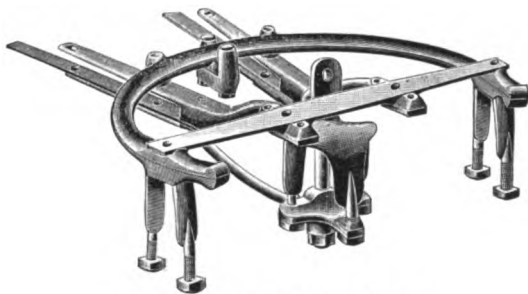

No. 1905—Gear Iron

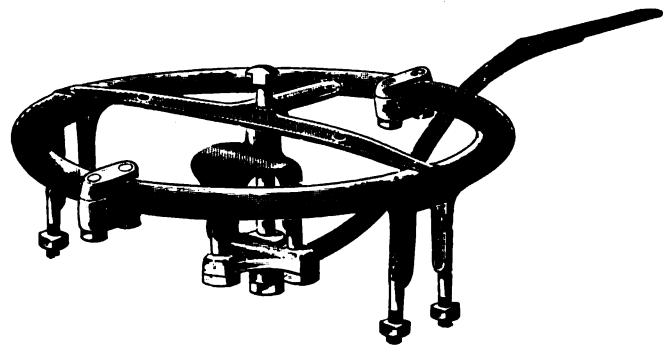

No. 1909—Concord.

Forget your trouble and decide at once to use WILCOX DROP FORGED IRONS. Write us for pleasure

The D. Wilcox Mfg. Co. Mechanicsburg Pa.

Please mention "The Hub" when you write.

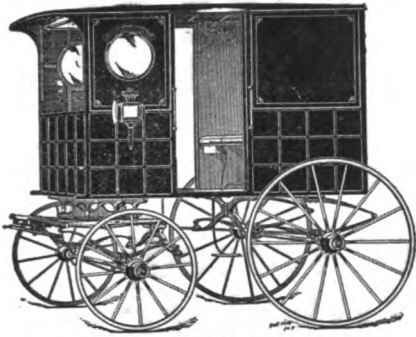

No. 112.—Milk Wagon.

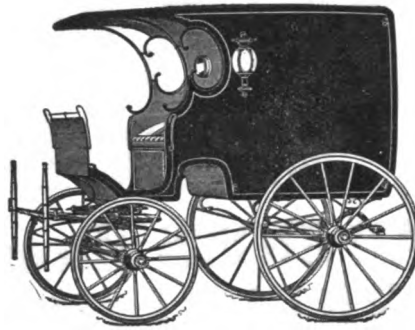

No. 111.—Altman Wagon.



No. 113.—Grocery Wagon.

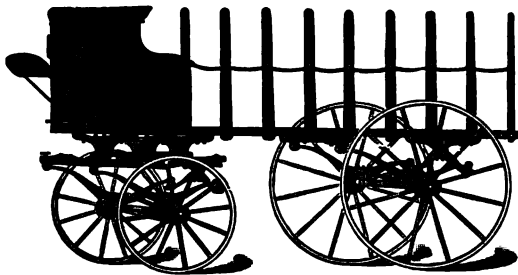

No. 122.—Flour Truck.

Electrotypes

of the vehicles presented on this page will be forwarded on receipt of

75 cts.

for each cut, to any address. Postage prepaid.

Catalogue

containing nearly 200 illustrations of carriages, wagons, sleighs, and miscellaneous cuts will be sent upon application.

Trade News Publishing Co.
24-26 MURRAY ST.
NEW YORK



No. 115.—Delivery Wagon.

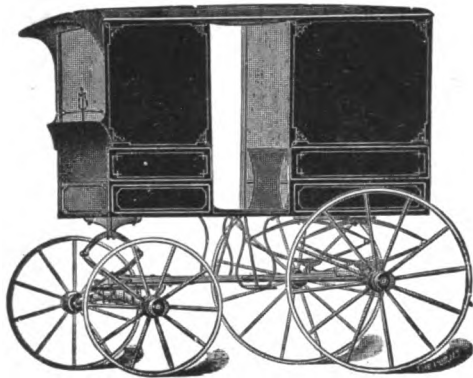

No. 116.—Milk Wagon.

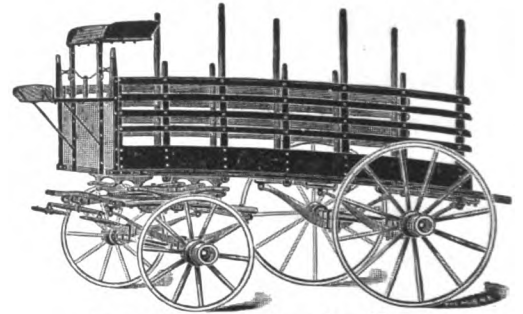

No. 117.—Merchandise Truck.

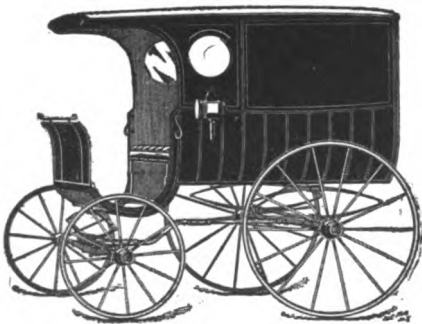

No. 114.—Delivery Wagon.

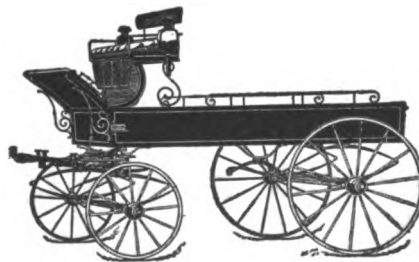

No. 124.—Delivery Wagon.



No. 118.—Ambulance.

Please mention "The Hub" when you write.

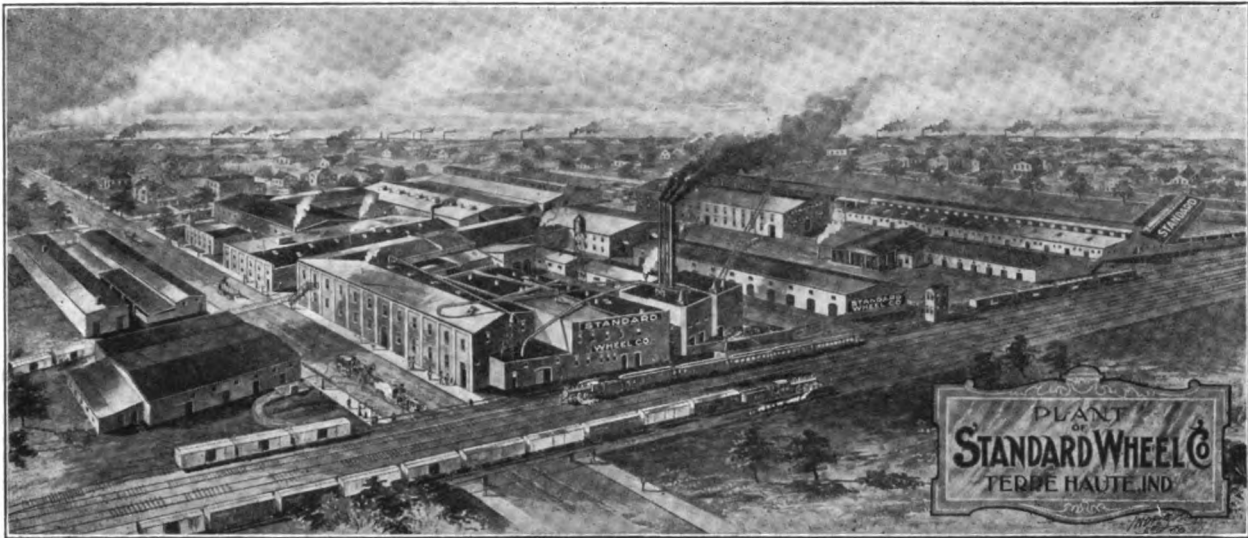

VEHICLE WHEELS AND WHEEL MATERIAL

Three Separate Departments [Light Carriage and Buggy Wheels
Heavy Express Wagon and Truck Wheels
Automobile Wheels

OUR GRADES ARE UNEXCELLED

WRITE FOR LIST.

Terre Haute, Ind. STANDARD WHEEL CO. Terre Haute, Ind

Richard Eccles Co., Auburn N. Y.

Manufacturers of

Forgings: Carriage, Wagon, Automobile, Special

Send for Catalogue.



VEHICLES AND GEARS IN THE WHITE



PREMIER SIDE SPRING GEAR

We manufacture a full line of Carriage and Wagon bodies in the white; also Limousine, Taxicab, Touring Car and Roadster Bodies for automobiles in metal. Fifty styles of gears for Carriages and Wagons; also seats, trimmings and tops of all kinds.

Write to us for particulars.

Schubert Bros. Gear Company

ONEIDA, NEW YORK.



The day of the vehicle that has to be taken to pieces to be oiled is doomed. The ADEN Axle Lubricating Device is inexpensive, simple and effective.

ADEN MFG. CO., Danville, Va.

Please mention 'The Hub' when you write.

F. W. DEVOE & C. T. RAYNOLDS CO.

101 and 103 FULTON STREET, NEW YORK

Manufacturers of

F. W. DEVOE & CO'S {
COACH COLORS
VARNISHES
BRUSHES
SPECIALTIES

C. T. RAYNOLDS & CO'S {
COACH COLORS
VARNISHES
BRUSHES
SPECIALTIES

FOR PAINTERS, ARTISTS AND DECORATORS

All the brands and specialties of F. W. Devoe & Co. and C. T. Reynolds & Co. will be maintained separately as heretofore.

NUMBER 20 BUGGY SPRINGS

Are for Buggies What Pneumatic Tires are for Automobiles

They are made in one size only and will fit all widths of piano bodies

Graceful in appearance The easiest riding spring on earth

ORDER A SAMPLE SET

THE MULHOLLAND COMPANY,

DUNKIRK, N. Y



Time Has Told the Story!

Service and satisfaction always follow our rolling stock

WHEELS

ALL KINDS—BEST QUALITY

Also RIMS and SPOKES

The Eberly & Orris Mfg. Co.
MECHANICSBURG, PA.

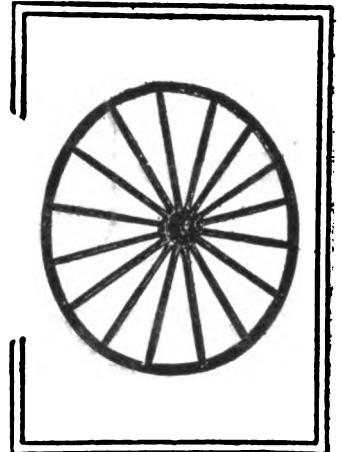
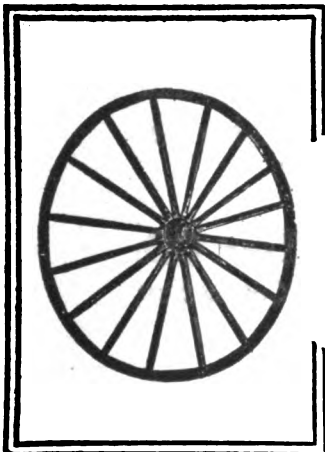

McKINNON DASH COMPANY

BUFFALO, N. Y.

**TROY, OHIO,
CINCINNATI, OHIO.**

**ST. CATHARINES,
ONTARIO.**

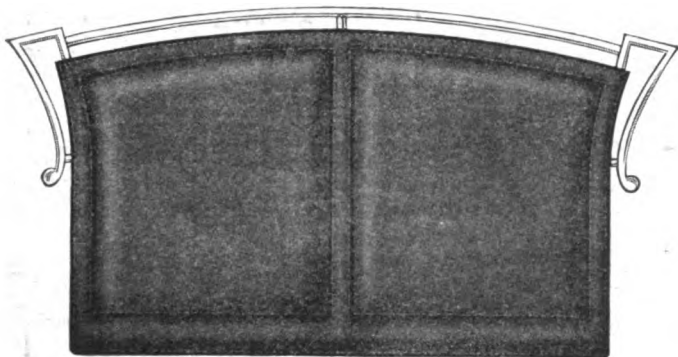

No. 171-N—With Nickel-Plated Rail.

HAVE YOU LOOKED OVER
OUR CATALOGUE SHOWING
NEW 1911 DESIGNS

Skewed Shaft Couplings

**Regular or Oval Patterns
For High Arched Axles**

Furnished in rights and lefts for any height of arch. Oval Axle
Clips $\frac{3}{8}$ or $\frac{1}{4}$ width to match Oval Couplings. Bolts, Clips,
Couplings, Carriage Hardware and Special Forgings

Catalogue "H" and Prices on Application.

COLUMBUS BOLT WORKS, Columbus, O.

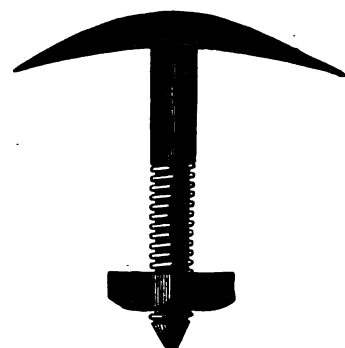
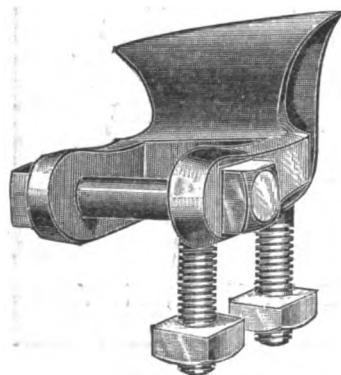

A. H. WIGGERS
Pres. and Mgr.

H. H. WIGGERS
Sec'y and Treas.

E. S. WIGGERS
Vice-Pres.

WIGGERS' BODIES

Automobile - Carriage

MERIT CONSIDERATION



Just One of Many Styles.

Because { THEY HAVE { Style
 { AND ARE { Quality
 { { Symmetrical Outlines
 { { Well Seasoned
 { { Made to Wear
 { { Priced Right

Address

The Wiggers Furniture Co.

Manufacturers of Carriage
and Auto Bodies and Seats

1417 to 1423 Plum St.

Cincinnati, Ohio

Mayo Radiators

have done their part in making
the splendid reputations of
America's best known cars.

¶ Can any maker afford to jeopardize his reputation and nullify his good work in other directions for the sake of a few dollars "saved" in the purchasing department?

MAYO RADIATOR CO.
New Haven, Connecticut

The Hub



**AUTOMOBILES
CARRIAGES
MOTOR TRUCKS
WAGONS**

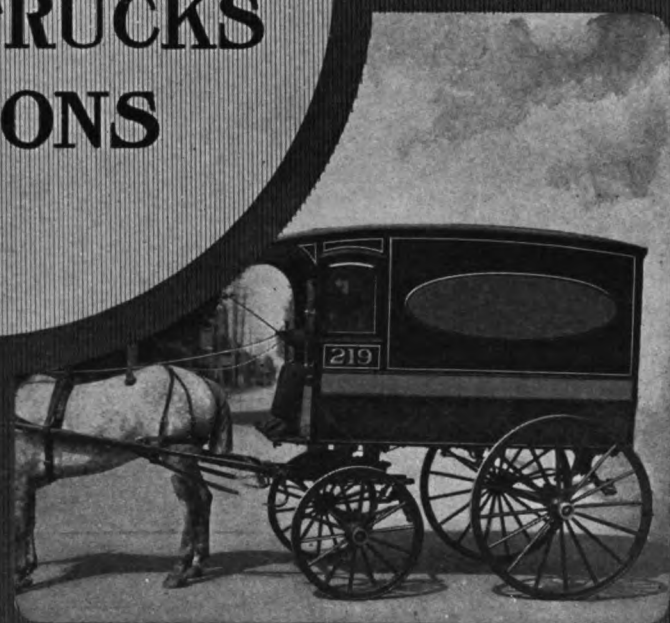

TRADE NEWS PUBLISHING CO
24-26 MURRAY ST., NEW YORK

Hoopes Bro. & Darlington Inc.

West Chester, Penna., U. S. A.

SARVEN
STAR or KENNY
Sweet Concealed Band
WOOD HUB
WARNER

WHEELS

HEAVY and LIGHT
for
CARRIAGES
WAGONS and
TRUCKS

IF YOU WANT THE BEST, TRY OURS



Load—Ten Tons of Coal.

SOLVED! Is the way motor car experts express themselves on the subject of tires for commercial motor vehicles after seeing and using the

KELLY-SPRINGFIELD SECTIONAL TIRE

With a grip on the road that means progress and security from the fault of solid tires—that of crowding the rubber ahead under load, which means disintegration—the motor wagon and truck owner will find in the Kelly-Springfield Sectional Tire the best tire for all heavy cars. Each section is dependent upon itself. If interested, write

CONSOLIDATED RUBBER TIRE COMPANY

New York, N. Y., and Akron, Ohio

Branches: Boston, Chicago, Philadelphia, St. Louis, Detroit, Cincinnati, San Francisco.



CRANE & MACMAHON, (INCORPORATED)

8-10 Bridge St., NEW YORK CITY, U. S. A.

Sole Manufacturers and Exporters of the

HICKORY NUT,  ACORN,  and STAR  BRANDS OF

Carriage, Wagon and Automobile Wood Stock

FACTORIES:

ST. MARYS, OHIO. RICHMOND, VA.

For Export Prices apply to the New York Office.

The Standard Automatic Brush

Does your painting work in a New Way—better, quicker, cheaper, eliminating all waste of paint. An equal flow at all times: thickness of coat can be accurately adjusted. Absolutely clean and fireproof.

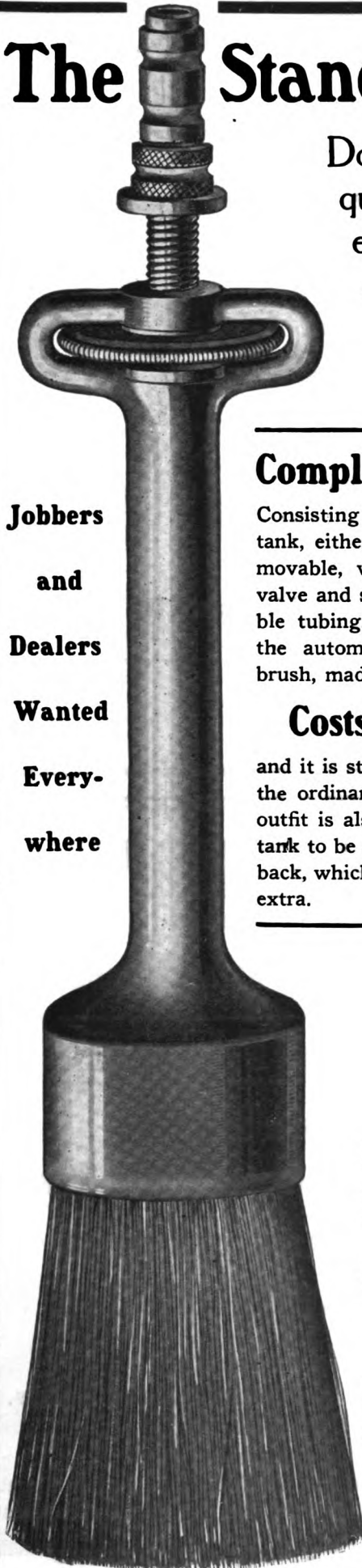

**Jobbers
and
Dealers
Wanted
Every-
where**

Complete Outfit

Consisting of a large paint tank, either stationary or movable, with automatic valve and six feet of flexible tubing, together with the automatic adjustable brush, made of aluminum,

Costs \$7.50

and it is still cheaper than the ordinary brush. The outfit is also made with a tank to be strapped on the back, which will cost \$2.50 extra.

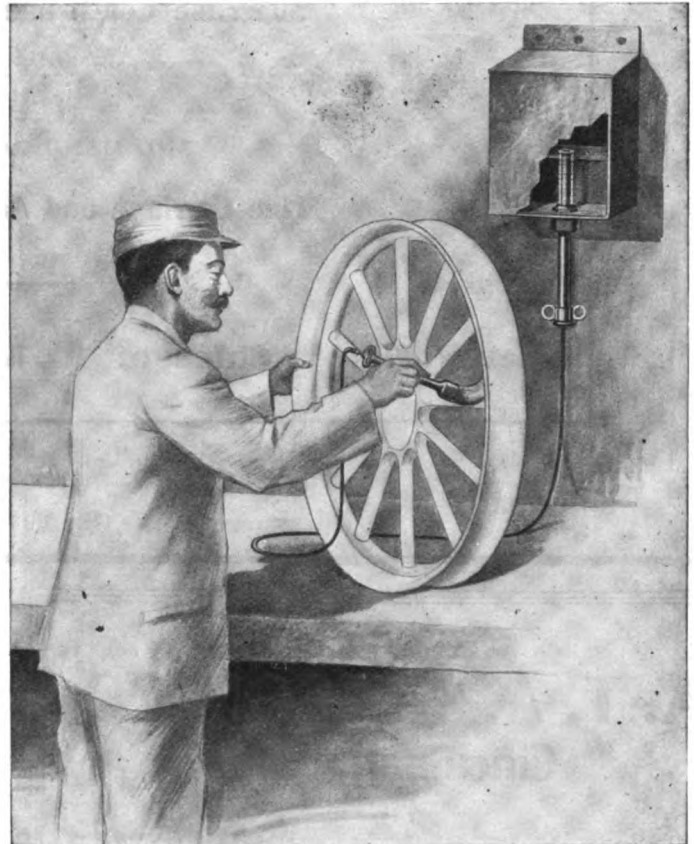

The Standard Automatic System Does Away with the Paint Can

It eliminates the dip and is far superior to the spray, but it does rub it in. No air pressure is needed. Will work with any kind of paint. **GET NEXT TO THIS NEW METHOD.** Made especially for manufacturers of automobiles, automobile bodies and wheels, all kinds of vehicles, carriages, etc.

Wherever duplication of work exists, this device will increase your output and reduce the cost. Buy just one outfit to-day and be convinced. We are sure that we will have to equip your entire plant.

OUR LITTLE BOOKLET WILL TELL YOU WHY.

Write for one to-day. Send in your order. Your outlay will only be once. Apparatus will last a lifetime. Special equipments can be made to suit your purpose. Let us know what you are manufacturing and we will effect a saving for you.

Standard Automatic Mfg. Co.
50 CHURCH STREET, NEW YORK

JOHN W. MASURY & SON

Originators of

Superfine Coach and Automobile Colors

Acknowledged the Standard for Fifty Years

AND MANUFACTURERS OF

Fine Carriage and Automobile Varnishes

New York, Chicago, Minneapolis, Kansas City

THE
A. T. A. NELSON CO.
Cincinnati, Ohio

Cut Leather

All Sizes, All Grades
Pole & Shaft Straps
Auto Straps

Vehicle Trimming Specialties

WRITE US QUICK

THE
A. T. A. NELSON CO.
Cincinnati, Ohio

JOHN REILLY Inc.

Established 1865

MANUFACTURERS OF ALL GRADES OF

LEATHER

FOR THE
Carriage & Automobile Trade

PARTICULAR ATTENTION CALLED TO
OUR AUTO SPECIAL

FACTORIES,
Avenues C & D, Murray & Astor Streets.
NEWARK, N. J.

AGENTS,
Cincinnati—National Hardware Co., Fourth Street
Detroit—C. W. Findlater, No. 313 Forest Ave., West

Please mention "The Hub" when you write.

THE AULT & WIBORG CO.

VARNISH WORKS

CINCINNATI, OHIO.

SUPERIOR CARRIAGE AND AUTOMOBILE VARNISHES



The Quickest Thing in Quick Rubbing Varnish; Saves Time and Trouble
READY TO RUB IN 24 HOURS

**If You Have
 VARNISH TROUBLES
 Come to us.
 We Have the Remedy.**

**Factory: Norwood, Ohio.
 Branches:
 New York, Philadelphia, Chicago,
 St. Louis, Toronto, etc.**

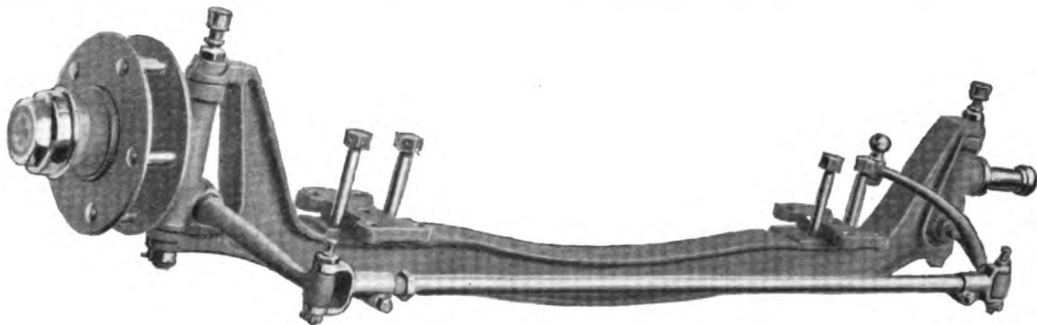

**TYPE F3-24
 FOR CARS WEIGHING UP TO 3,000 LBS.**

**I-BEAM DROP FORGED IN ONE PIECE
 PROPERLY "HEAT TREATED."**

HUBS ARE OF MALLEABLE IRON.

**BALL BEARING STEERING HEAD
 WHICH INSURES EASY STEERING.**

**STEERING SPINDLES AND ARMS ARE
 DROP FORGED FROM VANADIUM
 STEEL "HEAT TREATED" SO AS TO
 GIVE THE HIGHEST PHYSICAL PROP-
 erties POSSIBLE.**

**BEARINGS IN HUBS ARE THE IM-
 PROVED CUP AND CONE TYPE OF
 AMPLE SIZE ACCURATELY GROUND.**

**THIS FRONT AXLE CAN BE USED IN CONNECTION WITH
 OUR REAR AXLE TYPE 14 OR ADJUSTABLE TYPE NO. 2**

Write us regarding your requirements.

THE AMERICAN BALL BEARING CO.

**L. S. & M. S. RY. and EDGEWATER PARK
 CLEVELAND, OHIO**

Please mention "The Hub" when you write.

**Quality Is
Economy.**

*Varnish is a small item in the cost
of a Carriage or Motor Car.
Varnish-Room Trouble is a big item.*

Murphy Surfacers and Murphy Rubbing and Finishing Varnishes save their cost, many times over, in Varnish-Room Reliability—which means the Saving of Time and Labor.

They save the good will of customers also, and that is a special economy.

Murphy Japan Colors go enough farther to make them cheaper than colors at half the price.

The Varnish
That Lasts
Longest

Murphy Varnish Company

FRANKLIN MURPHY President NEWARK, N. J.
Associated with Dougall Varnish Company, Ltd., Montreal, Canada

BOSTON
CLEVELAND
ST. LOUIS
CHICAGO

**WILLEY'S
COLORS**

The **RECOGNIZED STANDARD**



C. A. WILLEY CO.

COLORS GRINDERS

and Manufacturers of Specialties in

CARRIAGE, AUTOMOBILE AND CAR

PAINTS

COLORS, VARNISHES, ETC.

HUNTER'S POINT, NEW YORK CITY

ESTABLISHED 1855

PHINEAS JONES & COMPANY

305-313 Market St., Newark, N. J.

**AUTOMOBILE
WHEELS**

For

PLEASURE CARS and TRUCKS

Repairing and truing old wheels a specialty. Experimental wheels a specialty. We furnish and apply any style demountable or detachable rim or tire.

KEYSTONE BLACK FILLER

MAKES A PERFECT

ROUGHSTUFF

For Automobile Bodies and Parts

It fills the pores of Metal and Wood perfectly. Sandpapers easily and produces a fine, smooth surface that DOES NOT CRACK, SCALE NOR PEEL.

POMEROY & FISCHER, New York
Selling Agents to Vehicle Trade

KEYSTONE PAINT AND FILLER CO., Muncy, Pa.

GOODRICH "SERVICE"

The Entrance to Rubber Street

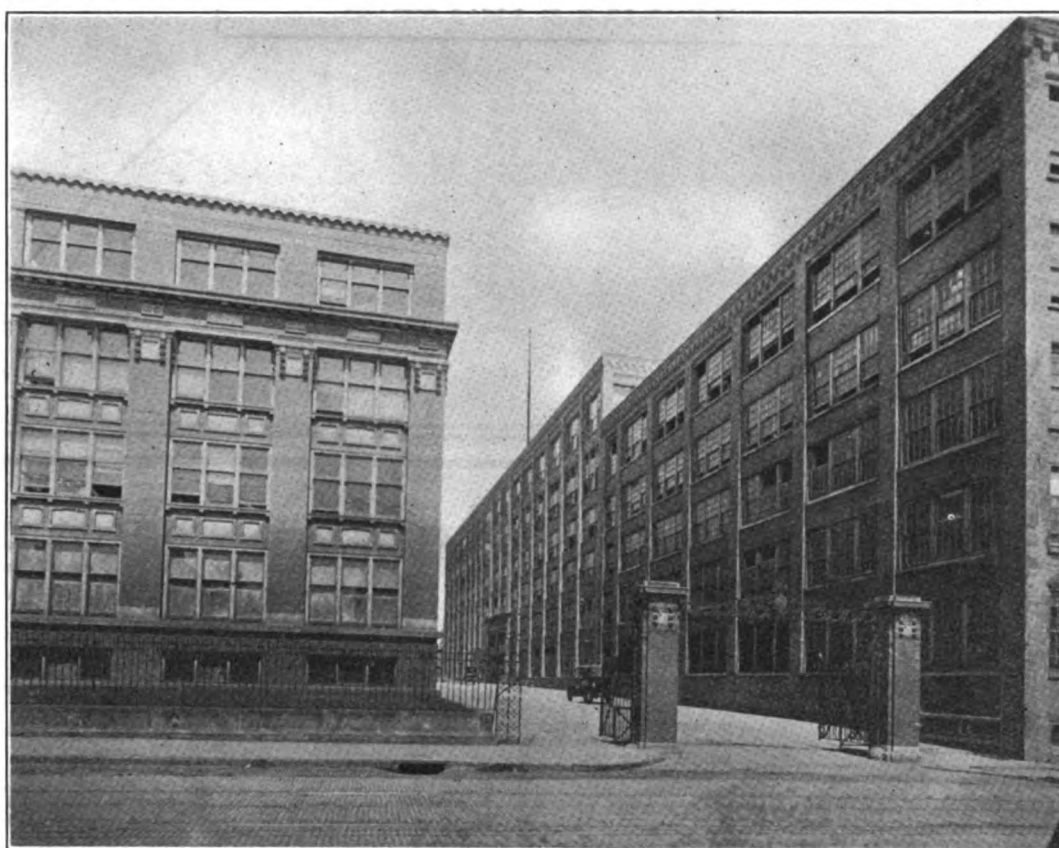

In the building on the corner (at the left) are the General Offices.

The two large buildings on the right are devoted almost entirely to the Departments of Tire Building.

The B. F. Goodrich Company

Akron, Ohio.

463

This is the whole number of vehicles exhibited
Madison Square Garden **Grand Central Palace**
 Jan. 7-21 (Two Shows) Dec. 31 - Jan. 7

463

Trade **VALENTIN** **ISHES** Mark

70%+

This large percentage of all vehicles employed
Valentine's Products

70%+

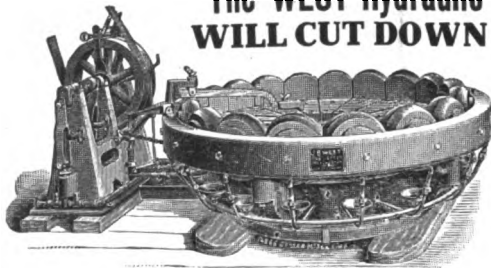

The WEST Hydraulic Tire Setter
WILL CUT DOWN EXPENSE

Tires set cold in one minute. This machine saves time — does the work better and quicker, does away with burned streaks. Only necessary to measure one wheel in a lot. Does not char the rim and

thus make the tire loosen prematurely. Saves re-sandpapering of wheels. This machine is now increasing the profits of many manufacturers. Send for catalog and read about it.

WEST TIRE SETTER CO., ROCHESTER, NEW YORK

Jones Wheels
 BEST ON EARTH

KANTSAMORE

Phineas Jones & Co.
 Newark, N. J.

MOLLER & SCHUMANN COMPANY

COLORED RUBBING

Most perfect as to working, drying and wearing.

CARRIAGE & AUTO VARNISHES

Send for color card and descriptive price list.

Chicago Branch - 110 N. Desplains St., Office and Factory - BROOKLYN, N. Y.

Please mention "The Hub" when you write.

The Hub

Copyright, 1911, by the Trade News Publishing Co. of New York.

Entered in the New York Post Office as Second-class Matter.

Vol. LII.

MARCH, 1911.

No. 12.

THE TRADE NEWS PUBLISHING CO. OF N. Y. Publishers of THE HUB

J. H. WRIGHT, *President.* G. A. TANNER, *Secretary and Treasurer.*
24-26 MURRAY STREET, NEW YORK.

Other Publications of Trade News Publishing Co.:

HARNESS (monthly) per year, \$1.00
AMERICAN HARNESS AND SADDLERY
DIRECTORY (annual) per copy, \$4.00

THE HUB is published monthly in the interest of employers and workmen connected with the manufacture of Carriages, Wagons, Sleighs, Automobiles and the Accessory trades, and also in the interest of Dealers.

Subscription price for the United States, Mexico, Cuba, Porto Rico, Guam the Philippines, and the Hawaiian Islands, \$2.00, Canada, \$2.50, payable strictly in advance. Single copies, 25 cents. Remittances at risk of subscriber, unless by registered letter, or by draft, check, express or post-office order, payable to the order of TRADE NEWS PUBLISHING CO.

For advertising rates, apply to the Publishers. Advertisements must be acceptable in every respect. Copy for new advertisements must be received by the 25th of the preceding month, and requests to alter or discontinue advertisements must be received before the 12th day of the preceding month to insure attention in the following number. All communications must be accompanied by the full name and address of writer.

FOREIGN REPRESENTATIVES:

FRANCE.—L. Dupont, publisher of *Le Guide du Carrossier*, 78 Rue Boissiere, Paris. Subscription price, 15 francs, postpaid.

GERMANY.—Gustave Miesen, Bohn a Rh. Subscription price, 12 marks, postpaid.

ENGLAND.—Thomas Mattison, "Floriana," Hillside Avenue, Bitterne Park, Southampton. Subscription price, 12 shillings, postpaid.

Beginnings of Heraldry.

The idea of armorial bearings is to typify an event of historic or personal moment, and then to use the insignia as a sort of identification mark for the "house" or family. In our commercial age "made in the United States" is a pretty good heraldic sign for most Americans, but it is devoid of romance though redolent of the dollar.

It is interesting, however, to trace the cold storage history in many armorial bearings.

Take, for example, the head of a deer, not uncommon. We find one with a cross between the antlers. It originated in an event in the life of David of Scotland. The pious king went a-hunting on Holyrood Day, which no pious king should do, of course, so when a stag charged his sacred person and nearly did for his majesty, he was only rescued by the prompt aid of a servitor.

The king saw in the incident that Providence was reproving him for hunting in the "closed" (religious) season, and as a mark of his recognition of the event he concluded to build a church, and he gave it a label, so to speak, and it was the head of the stag. To add the proper religious flavor he placed a cross between the horns.

The faithful attendant who saved the life of the king was named Crawford, and as the stag and cross seemed

to him to apply to his act as much as it could to a church foundation, he took it, and it is the label that classifies his family to-day in Scotland.

Looked at in this light it is very romantic and impressive, but if conspicuous deeds in commercial life were to be as justly emblazoned what a comical aggregation of symbols we would paint in the panels of the fortunately rich!

Old Automobiles.

If the automobile club in this country should do the same as the same institution in France did, and issue a call for the assembling of old, used cars, giving a medal for the oldest, it would be interesting to observe how many "models" would come to scratch, and what would be the oldest vintage that could be uncorked.

Abroad quite a large assortment of arks came forth, all in more or less constant service, as far back as 1900, and in the try-out they were successful in doing all that was asked of them. The Frenchman is not partial to the swift change of front so common with us and rather likes his old, familiar first purchase, as long as it will stand up and do its work. He does not seem to be sensitive to the reproach of not being up-to-date, or so anxious to wear the latest fashion as we Americans.

It would be interesting as a test of material and construction to have an exhibition of the old stagers that we have practiced on, if only to know if any of them are competent, structurally, to "come back."

Evolution of the Dashboard.

The scuttle dash board, as it is named, is making quite a change in the arrangements of the front of the autocar. In the first place it is taking out more space on the chassis, it is making the handling of the windshield more of a problem, and it is crowding the seating capacity if the base is not lengthened.

It seems to be meeting with much favor, and fewer straight dashes are seen. The arrangement of the front doors, or fore doors as they are now named, are something of a puzzle, too, as they are likely to rattle and be that much of a nuisance. The steering post has to be dropped to a more acute angle, too, and altogether, the innovation is quite a consumer of valuable space. If it should serve, somehow, to get the rear passengers in a position of comfort where the influence of the rear axle would not jump them up and down, as if they were individual grains of corn being popped in a hopper, it might lead to a decided improvement in design.

The Exhibit Habit.

Following the lead of the Carriage Builders' National Association, the custom of making exhibits of articles interesting to those gathered in convention, has grown apace.

The implement and vehicle associations are becoming prominent in this respect. The various state meetings seem incomplete without an array of vehicles and implements in some suitable place during convention time.

It must be a very expensive habit for the manufacturers to acquire, but there must be something desirable to be gained or the custom would wane in place of waxing as it is doing.

This is supplemental to the efforts made at fairs, so it must be very expensive advertising, all in all.

It comes especially hard on the vehicle builder as his styles are so numerous and varied. If it was only a corn planter proposition it wouldn't amount to much more than carfare and hotels.

The trouble with efforts of this kind is the tendency to overdo them. The corrective is the abuse of the idea, of course, but it costs much before arriving at that stage.

Cleaning the Auto.

The painted and varnished surface of the automobile is much harder to keep in a clean state than the ordinary vehicle. Varnish makers seem to be recognizing this in the new varnish compounds they are putting on the market especially adapted to motor car painting.

All the well known advice about washing carriages applies to its bigger cousin in even greater force, with some suggestions that are entirely new. The speed of the car is an agent for throwing the mud with such force that it seems to stick harder than on the usual kind of vehicle.

We would think the new mat finishes that are being supplied in the varnish used for automobile work would prove very welcome.

Must Use Benzol.

The Society of Automobile Engineers has been discounting the forthcoming scarcity of gasoline.

It is the opinion of some of the members of the society that benzol is the coming substitute.

The great quantities of coke available from coal, and the by-products that are available from such material, especially coal tar, having yielded so many valuable products, is now presenting benzol as the substitute for gasoline for internal combustion engines.

"Clean benzol" is being used now in Germany, but not yet with complete satisfaction, due probably to lack of a suitable carburetor.

Two of the derivatives known as toluol and xylol have been found quite suitable for automobile use. From 100 pounds of coal there can be obtained one pound of a suitable fuel for motors.

It looks as if benzol will become quite as familiar a word as gasoline in the near future.

MOST INTERESTING ENTERTAINMENT.

On the evening of February 4th, the Automobile Club of America, in its splendid club house in New York City, gave a moving picture and stereopticon exhibition for members that was interesting. The photographs were taken on the excursion of Mr. Paul J. Rainey in Arctic waters in search of "big game." The explanations were afforded by Mr. Richard E. Follett, himself a fine sportsman, but whose predilections are in the line of salmon fishing. He entertained the company, as a preliminary, with some of the most impressive pictures of the sport of salmon fishing, being the true graphic account of his own experiences. It is quite a commentary, by the way, of the new way of following a life of sport, that those who can afford it take along their privately owned moving picture outfits, operator and all, and bring back the record of exploits in a permanent fashion, which beats fish stories, etc., by many leagues.

Mr. Rainey's pictures showed walrus and polar bear captures, among others, as exciting as anything that could be staged spectacularly. At the conclusion of the exhibition there was the usual luncheon and social meeting.

Too many compliments cannot be bestowed on the members of the entertainment committee, Messrs. George D. Barron, Har- den L. Crawford and Emerson Brooks, for the clever and enter- taining manner in which they have composed their series of entertainments.

ANTIQUITY OF THE LATHE.

From an early treatise by Moxon, published in 1680 in Eng- land, it is certain that at that time the lathe was developed to a point where it was possible to turn out high-class ornamental woodwork, including oval shapes, but a lathe was invented. Devices was beyond its power until the slide rest was invented. Devices for clamping the cutting tools in a fixed position were employed comparatively early, but the first appearance of an excellent dates from 1772. Complete drawings and details of an excellent slide rest were given in that year in a French encyclopedia. As early as in 1741, Hindley, a York clockmaker, produced a screw cutting lathe with change gears. This, of course, was a very small machine, and, in fact, the clockmakers of that day seemed to have a monopoly of mechanical ingenuity.—Machine

CHANGE OF OWNERSHIP.

The Scranton & Co., of New Haven, has sold to E. R. Cald- well & Co., Bradford, Pa., the Scranton power hammer, and the latter firm will continue its manufacture and distribution.

FORGET IT.

If you've made a grave mistake—

One you didn't mean to make,

—Just—forget it!

Don't let it cause you pain,

Just don't make the same again,

—And—forget it!

There are many more like you

Who have done the same thing, too,

—So—forget it!

There's a future in this w

And to those it is unfurled

—Who—forget it!

So buckle up your mind,

And encouragement you'll find

—To—forget it!

Make up your mind "to dare and do,"

And good things will come to you;

—So—forget it!

—New York American.

Vehicle Fashions for March 1911



ALCO THREE-TON TRUCK.
Built by American Locomotive Company.

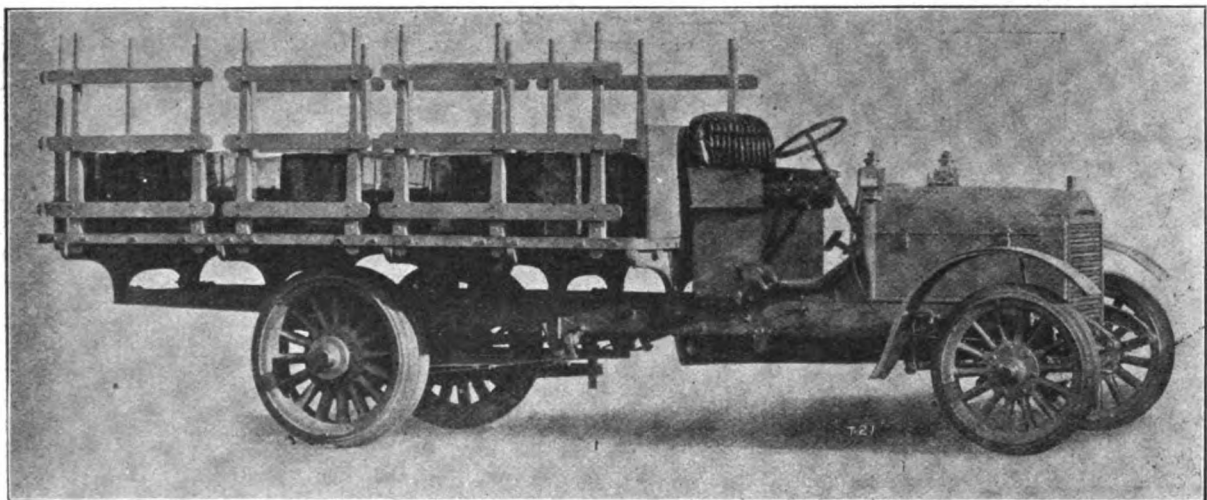

PIERCE-ARROW FIVE-TON TRUCK.
Built by Pierce-Arrow Motor Car Co.

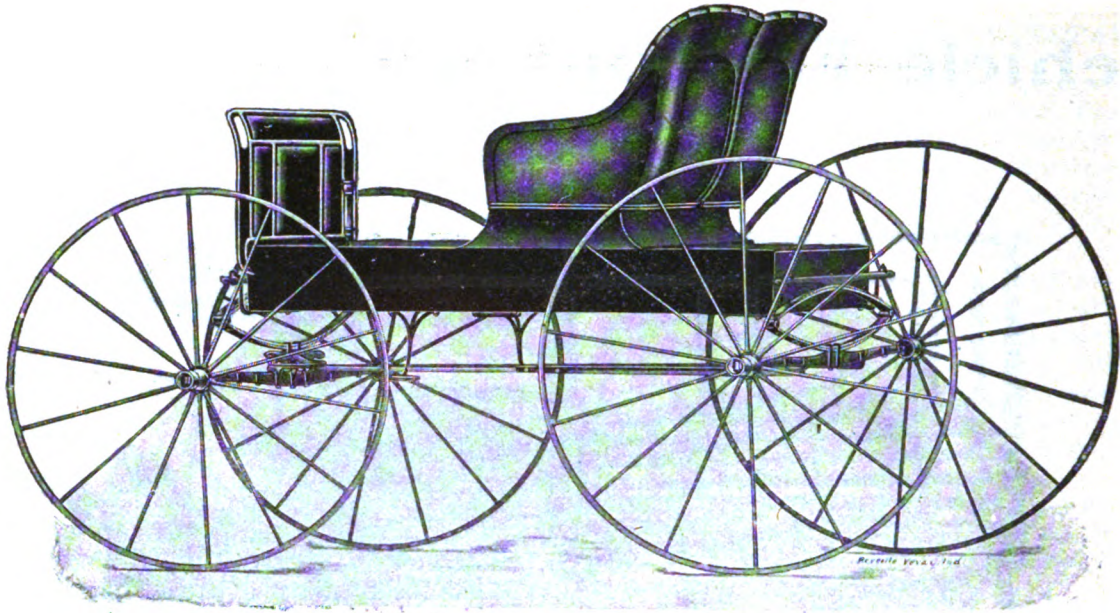

LIGHT BUGGY, PANELED AUTO SEAT.
Built by Lull Carriage Co.

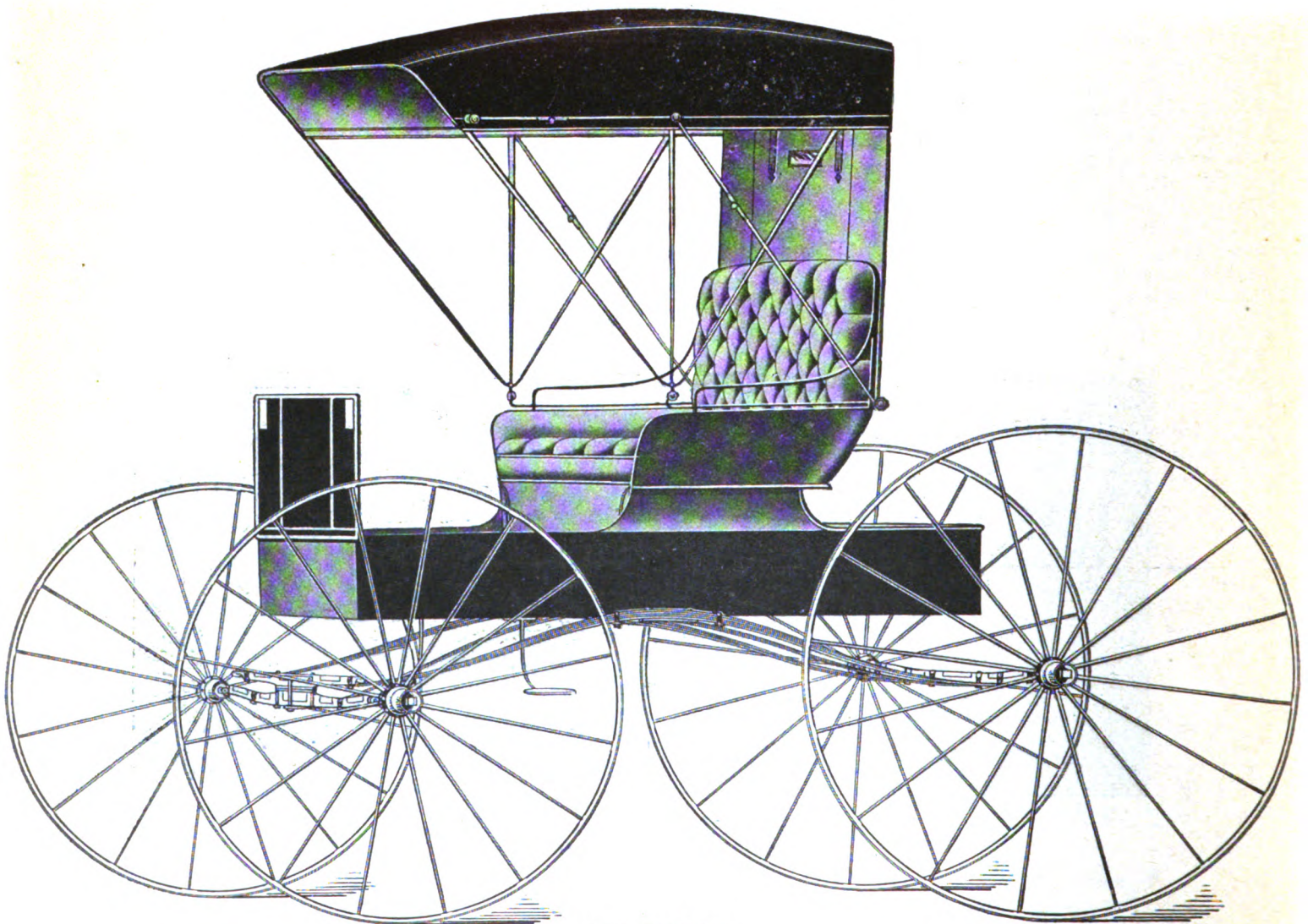

TOP BUGGY
Built by Parry Mfg. Co.

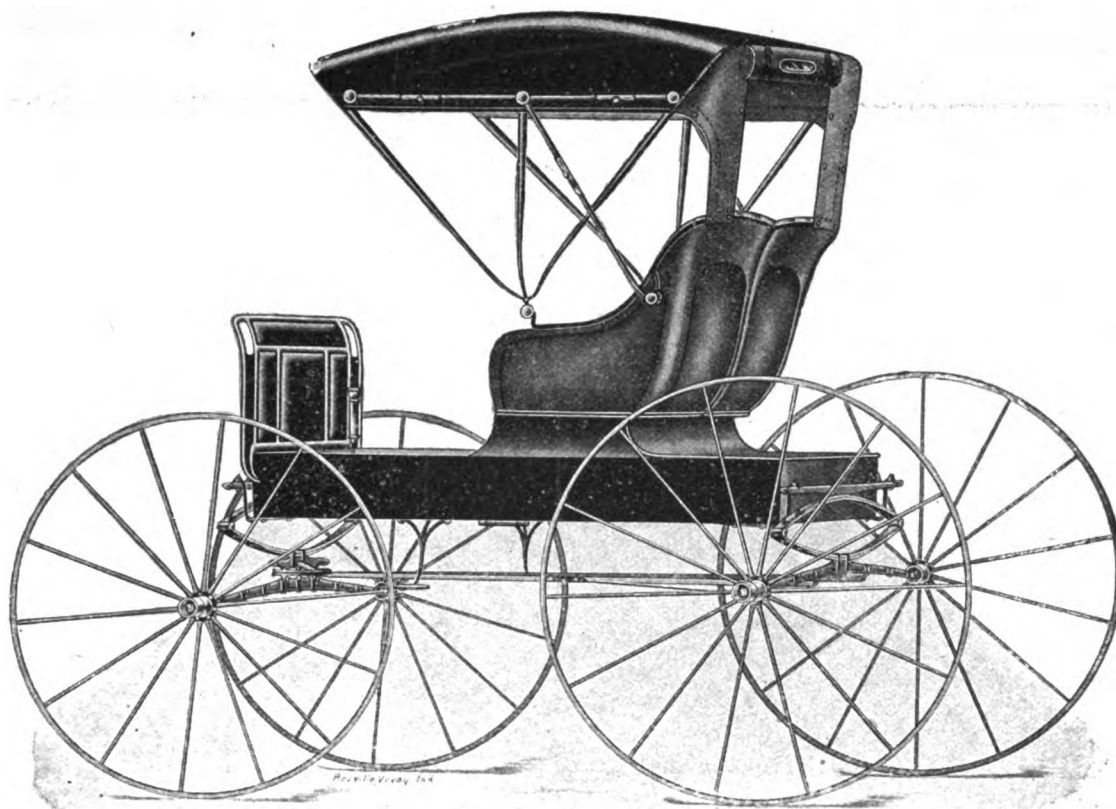

TOP BUGGY Built by Lull Carriage Co.



DELIVERY WAGON. Built by Hoover Wagon Co.

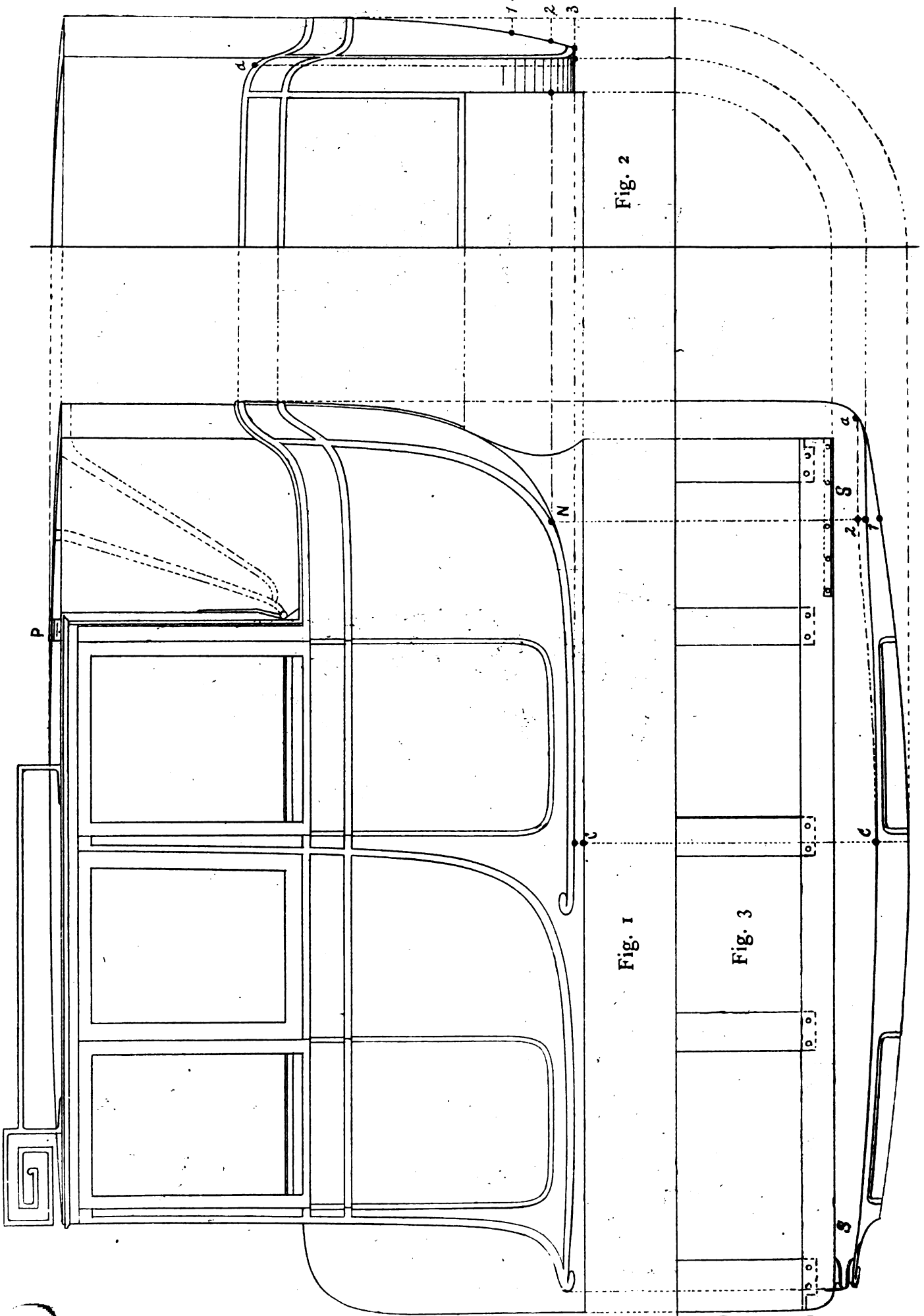

(Described on Opposite Page.)

WORKING DRAFT OF A SALOON CAR BODY.

Wood-working and Smithing

WORKING DRAFT OF A SALOON CAR BODY.

(Drawing on Opposite Page.)

In this issue we give a working draft of a saloon car body, suitable for a 40 horsepower engine. The touring motorist requires a car of ample capacity both for comfort and speed. A car for this purpose must have a comfortable seating room for each occupant.

This body is designed with cabriolet quarters, which allows a full and extending controlling line to be fashioned. The front body is furnished with a coupe pillar the base of which is finished with a return scroll eye. The doorway is strengthened with a hollowed corner for strength to the pillar at its base. The door is better for clearance and more easily opened with the spring lock to shut on the standing pillar, and hung in the hinging to the coupe pillar.

The half head behind falls like a landau. The joint of the head cross slat is covered with a valance plate, which is made to hinge up for the half head to joint itself to the body standing pillar. The plate is made to project an inch over the joint of the half head slat to keep the weather from drifting in; an additional fixing is fitted to the inside of the slats, as in the ordinary plated head locks, which, when pulled into position, clinches the locking to a firm binding, in drawing the valance plate tightly down to a clean and firm bearing to the half head cross seat.

The center seats of the body are made to lock round to any position that the occupant may desire to sit in. They are of ample size for comfortable seating, and have high back rest squabbing and elbow rests to the sides of their quarters. In a saloon car these matters require a thoughtful attention, because comfort is as essential as speed and safety, while the beauty of design and high finish are greatly discounted if they are absent.

The body is flush sided in construction and, though an imposing looking car if highly finished, yet there is no mystery in its construction to the body maker of matured talent and a ready adaptability. In fact, the whole secret of motor body building is adaptability, from the lines of horse carriages to those of motors; from the constructional lines of broughams, victorias, landaulettes and similar bodies, to those of horseless bodies in motor work. This is all the mystery about the change—nothing more.

The saloon body shown is made in its framing with coupe pillar, front body, standing pillar, centre pillar, which is the shutting pillar of hind door; hind standing pillar, and hind curved corner pillar. These are all framed into the bottomside, which is left with full corners to take the pillars, which also have curved corners to build up the formation in the design.

The corner pillar of the hind body is slip-tenon framed to the bottomside and an independent piece is screwed to it, so that the round corner can be worked up as in the plan. The quarters are all made of mahogany panelling and gigger grooved, as defined by the moulding lines. The belt panel of the body can be made in solid framing, and the moulding and panel worked up by boxing out in the solid. Or it can be panelled in mahogany as the bottom quarters are done, or the bottom belt moulding can be placed on as many builders do, though all planted work partakes more or less of the gerry builder. No high class coach maker does work in this way.

Metal panels are not fit to be compared to wood panels in durability nor in solidity. Metal panelling gives no stiffening effect to the framing, which soon shows up defects, which the straining of wear and tear bring to the surface.

This body is in effect a double bodied landaulette. The hind standing pillar and the bottomside should be strengthened with a light steel edge plate. The framing of pillars should be secured with center bolts and nuts let into the pillars and the shoulders screwed firmly down to the bottomside. This method of framing has been fully explained in previous issues of The Hub. These things are well to keep in mind, as each new construction requires a different means of strengthening the framing effectively.

Fig. 1 shows the elevation design, the body is really a limousine, with the additional landaulette fitting to the hind half head. The head pillar is check fitted to the body pillar, and the valance plate, P, is made to hinge up to allow the head pillar and cross slat to joint into position, the head being held to position by inside head lock fittings. The bonnet pillar fitting gives inside space towards the engine, and extra room for the levers to be handled by the chauffeur.

Fig. 2 shows the half back section in which is shown the back panel design and the working up and position of the mouldings on the rounded corner, and the rocker position and panel, and body top cross rail.

Fig. 3 shows the half plan of body. It will be seen that the bottomside takes up the width from the turnunder line, C, to the inside, where the cross bars are framed into the line S—S is the edge of the half width of the chassis. The rocker piece is shown half check framed into the bottomside, the rocker space from the body moulding being boxed out on the bottomside throughout.

The body is built to a faint side sweep, just sufficient to allow of the central widths and the cross widths at back and front. The turnunder is of a contour to give a full curve to harmonize with the body's design. The turnunder lines in the plan call for an explanation here, because they are set off in their position as measured off from the half back section, Fig. 2. The propped off star points on the turnunder in this section are projected to the half plan and it will be seen that the full turnunder follows to the corner pillar point N, and down to the plan at point 2, and on to point a, and point a in the half section. The corner being rounded, the turnunder line shows its position by dotted line, this line is, of course, the same distance in from the base line as the turnunder in the back section at point 2.

The turnunder line at point 1 shows the amount of turnunder in the half section at point 1, and returned to the elbow point. This is all that need be explained of the half plan, which to the experienced body maker will be easily read. Point 3 is the full turnunder, and is shown in the plan at point C. The half head can be made to shut under the head valance plate without the plate being made to hinge up; each builder in this particular of head fitting has his own way.

The sizes for building are as follows: Length of body on chassis line, 8 ft., 7 in.; width of body on back on corner pillar line, 45 in.; width of body across front pillars, 4 ft; across front standing pillar, 4 ft. 5 in.; across center pillar, 4 ft. 7½ in.; width of front door, 20 in.; width of hind door, 23 in.; width of front quarter on moulding line up to door line, 24 in.; width of hind quarter on elbow line from door to body moulding, 24 in.

Depth of waist belt over mouldings 5¾ in.; depth of hind quarter from bottom of waist belt moulding over bottomside moulding on door line, 26½ in.; depth of front quarter on door line, 26½ in.; round on back of body from corner pillar point, 5¼ in.; the hind head slat is cut out to this rounding in its corners to the line of the body as shown in the plan Fig. 3. Width of coupe pillar at base over eye from door line, 10¼ in.. It will be seen that

the back corner pillar line vanishes to the bottomside line conically. The pillar requires to be nicely rounded over from the elbow point width to the vanishing point of the cone at N, and paneled down, that is, boxed down a full 1/4 in. as defined by the moulding lines. The body projects over chassis at center on point C 5 in.; width of chassis, 38 in.

FRENCH FOLDING WINDOW FRAME.

The accompanying design represents a special window frame for carriage tops not usual in this country. It can be adapted to leather tops of victorias, phaetons, etc., and offers the possibility of a well closed carriage. It is similar to the automobile window screen.

The front bow, A, in Fig. 1 is of wood, which on the high rounded has a panel, B, (Fig. 1 and 2), giving an even line on

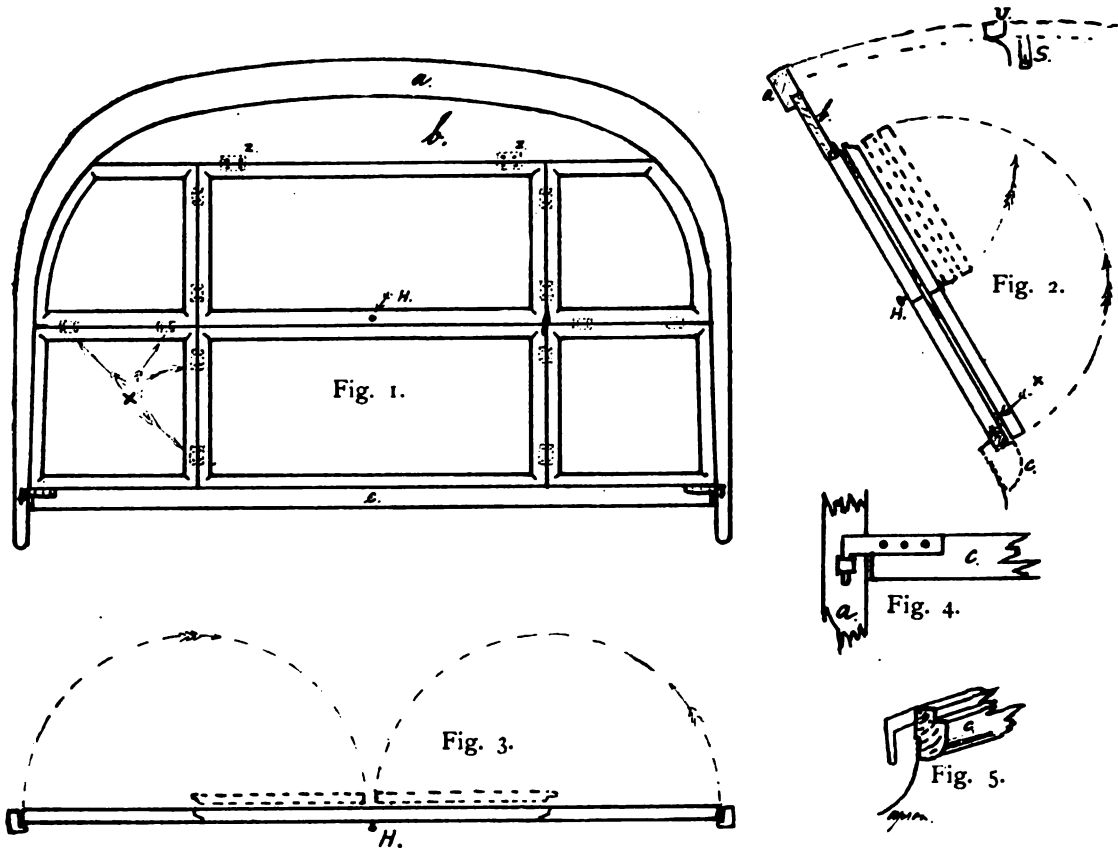

which to hang frames, brass hinged. The wooden bar C, Figs. 1 2, 4 and 5, supports frames and is attached to the front bow as shown in Fig. 4 and 5. It can be taken easily away. To this bar a leather or curtain apron is fashioned, either with nails or curtain fasteners, to close lower part of vehicle. The six window frames are bound one to the other on inside by brass hinges.

The principal design, Fig. 1, shows the top closed, or the window open. To open the left and right sides the small frames are first folded in, Fig. 3. Fig. 2 shows this from the side; then lower part is folded in to the upper part, and then the whole raised and fastened to the second bow of the top, U, with a leather snap, S, to the button H, Fig. 2. In this position the frames are nearly invisible, and the top can always be folded. The apron can be rolled, hung, or entirely removed.

The frames are mostly made of walnut, mahogany, palisander, beech or ash wood, varnished or polished, and when fitted with bevelled glass are a fine ornament, and remind one of the old fashioned window framing system, for which we have the German word, "Biedermeier style."

The new system of aluminum window frames would be a good arrangement for this purpose, and would have the advantage of lightness.

BRAZING.

A very practical article on brazing that ought to be of value to the worker in the smith shop is from the pen of a writer in the Wood Worker. We think it will be of interest to reproduce parts of it for the benefit of the worker in metal in the carriage and wagon shop:

The steelmaker takes a piece of steel, we will say, for example, from 100 to 120 per cent carbon, and with the use of heat and water or some kind of bath, he heats the steel to a red heat and suddenly cools it. Of course, it is very hard—too hard for any kind of cutting tool. Then, by the reheating process, he arises the temperature to 430 deg. Then the bright steel will show a pale straw color, and the degree of hardness is reduced to a suitable temper for razors, nice-cutting tools, surgical instruments, etc. If he had raised the temperature to 490 degrees he would

have a temper suitable for scissors and less valuable tools. If he had raised it to 530 deg. he would have gotten a purple color, which is considered very good for wood-cutting tools. Six hundred degrees would have given a dark blue color, the lowest degree of hardness, much too soft for any of the better quality of cutting tools.

Now, the colors as above given can be applied only to steel harder than desired, where you wish to reduce the temper to a softer degree of hardness. The colors, of course, are only films of oxide on the surface, yet to the trained eye they show unerringly the degree of hardness attained, the original temper being known and the quality of steel 22 per cent carbon.

You will notice the temperature of 430 degees leaves the hardest temper, yet softer than the original, 490 degrees, a little softer, 530 degrees still more soft, and 600 degrees the softest. Nothing about this shows that reheating will give a harder temper. I have a different way; perhaps some may call this "embryonic," but the only way I know to harden steel is to cool it while it is hot. or as I think of it, retain what you already have by suddenly cooling it while it is hot.

I take a handful of waste, moisten with water and brush the lap lightly and quickly after removing the iron. When it siz-

zles to my satisfaction I cool it quickly with water or oil; perhaps the latter is a little less liable to caseharden. Either, however, will do the trick if properly used. With a little careful practice one can get the desired degree of hardness nearly every time. I always make sure and stop the temper at the braze as hard, if not harder, than desired, and never allow the heat to run too low before cooling. Then, if it is too hard, I draw the temper to suit with hot irons or a blast torch.

But reheating certainly softens a piece of steel, especially as close-grained steel as that of which band saws are made. The colors, I find, are not always reliable except to the expert, and he must have the appliances to stop the temper running instantly, or he will not get the desired temper, as the colors run very rapidly in a thin band resaw; of course, in thicker gage saws, correspondingly slower.

Tempering steel, according to Webster, in a strict sense of the word, is the application of heat to a hardened piece of steel to draw the temper to a desired degree of hardness, although it further states that "the word is loosely applied to the combined hardening and reheating."

A braze, of course, can and ought to be tempered exactly or nearly the same as the rest of the saw; the nearer it is the better the results will be. But this can be done only on the first heat made by the irons. If you attempt to reheat a braze hot enough to get a harder temper, you will surely weaken the solder or perhaps let it apart altogether.

THE SMALL SHOP AS AUTO REPAIR SHOP.

Here is what one who has looked the field over has to say about the small builder getting into the auto repair business: I have talked with coachbuilders in regard to the repair business. They have the impression that it takes an enormous amount of capital to fit up a shop for the work. Now their smith has his regular tools, such as wrenches, dies, drills, hammers—many of them lathes. What more could he want for the average job? About the only thing that will give the average man a little bother will be the tire proposition, but the vulcanizer will not call for any great outlay of capital. Aside from this a few tire tools will be necessary to remove and replace the tires. In many cases they will be found in the auto kit. If every coachbuilder will add a vulcanizer to his already equipment of tools he can do a great share of the automobile repairing that comes in. Hang the sign above the door, and almost before you know it you will be an automobile repairer head over heels in work.

Of course, there are a number of parts aside from the engine that are likely to give trouble, such as the ignition system, carburetor, cooling system, etc. Then there are the axles, the wheels, frames, springs and such like that the practical man will have no trouble with. Motor troubles are generally not of a serious nature, although once in a while he may possibly be called upon to repair a badly damaged motor. But it is an exception rather than a rule that the repair cannot be made quickly and easily.

Broken valve springs, cracked cylinders, broken rings and such like will sometimes tax the ingenuity of the smith, but if good common sense is mixed with mechanical training he will accomplish a repair for the autoist and a generous fee for himself. It is almost impossible to outline or detail the troubles that will be brought to the attention of the smith, but I will mention which are the most common. The ignition system gives as much trouble as all the rest of the car put together. While, of course, the lubricating system, cooling system and the fuel supply will need attention as well as the engine.

TO DISTINGUISH STEEL.

An effective way of distinguishing high speed steel from carbon, or tool and machine steel, is to hold the piece in question against an emery wheel. If the sparks are red it is high speed steel, if white it is machine or tool steel.

STOCK FOR BENT SHAPES.

It is often necessary to cut the stock for a forging as nearly as possible to the exact length needed. This length can generally be easily obtained by measurement or calculation.

About the simplest case for calculation is a plain right angle bend, of which the piece in Fig. 1 will serve as an example. This piece as shown is a simple right-angle bend made from stock one inch through, eight inches long on the outside of each leg.

Suppose this to be made of wood in place of iron. It is easily seen that a piece of stock one inch thick and fifteen inches long would make the angle by cutting off seven inches from one end and fastening this piece to the end of the eight-inch piece, as shown in Fig. 2. This is practically what is done when the angle

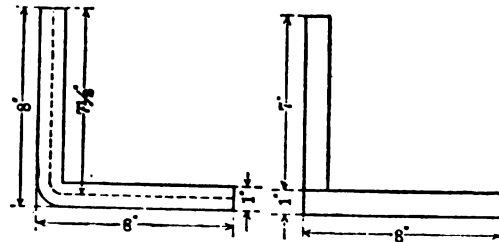

FIG. 1.

FIG. 2.

is made of iron only; in place of cutting and fastening, the bar is bent and hammered into shape. In other words, any method which will give the length of stock required to make a shape of uniform section in wood, if no allowance is made for cutting or waste, will also give the length required to make the same shape with iron.

An easier way—which will serve for calculating lengths of all bent shapes—is to measure the length of an imaginary line drawn through the center of the stock. Thus, if a dotted line should be drawn through the center of stock in Fig. 1, the length of each leg of this line would be seven and one-half inches and the length of stock required fifteen inches, as found before.

No matter what the shape when the stock is left of uniform width through its length, this length of straight stock may always be found by measuring the length of the center line on the bent shape. This may be clearly shown by the following experiment:

Suppose a straight bar of iron with square ends be taken and

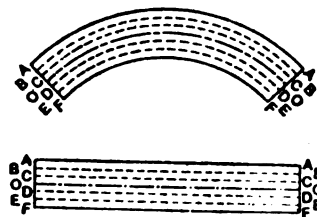

FIG. 3.

bent into the shape shown in Fig. 3. If the length of the bar be measured on the inside edge of the bend and then on the outside, it will be found that the inside length is considerably shorter than the outside; and not only this, but the inside will be shorter than the original bar, while the outside will be longer. The metal must therefore squeeze together or upset on the inside and stretch or draw out on the outside. If this is the case, as it is, there must be some part of the bar which when it is bent neither squeezes together nor draws out, but retains its original length, and this part of the bar lies almost exactly in the center, as shown by the dotted line. It is on this line of the bent bar that the measuring must be done in order to determine the original length of the straight stock, for this is the only part of the stock which remains unaltered in length when the bar is bent.

To make the explanation clear, says The Horseshoers' Journal, suppose a bar of iron is taken, polished on one side and lines scratched in the surface as shown in the lower drawing in Fig. 3, and this bar then bent into shape shown in the upper drawing.

Now, if the length of each one of these lines be measured and the measurements compared with the length of the same lines before the bar was bent, it would be found that the line AA, on the outside of the bar, had lengthened considerably; the line BB would be somewhat lengthened but not as much as AA and CC would be lengthened less than BB. The line OO through the center of the bar, would measure almost exactly the same as when the bar was straight. The line DD would be found to be shorter than OO and FF shorter than any other. The line OO at the center of the bar does not change its length when the bar is bent; consequently, to determine the length of straight stock required to bend into any shape, measure the length of the line following the center of the stock of the bent shape.

As another example Fig. 4 will serve.

Suppose a center line be drawn, as shown by the dotted line. As the stock is one inch thick, the length of the center line of



the part A will be five inches, at B eight inches, D two inches, E three and one-half inches, and the total length of stock required twenty-two and one-half inches.

A convenient form of making calculations is as follows:

A, 5 inches; B, 8 inches; C, 5 inches; E, 3½ inches; total, 21½ inches of stock required.

On circles and curves there are several different methods which may be employed in determining the length of stock, but the same principle must be followed in any case—the length must be measured along the center line of the stock.

One way of measuring is to lay off the work full size. On this full size drawing lay a string or thin, easily bent wire in such a way that it follows the shape of the bend through its entire length, being careful that the string is laid along the center of the stock.

The string or wire may then be straightened and the length measured directly.

Irregular shapes or scrolls are easily measured in this way.

Another method of measuring stock for scrolls, etc., is to step around a scroll with a pair of dividers with the points a short distance apart, and then lay off the same number of spaces in a straight line and measure the length of that line. This is of more use in the drawing room than in the shop.

PONTIAC WHEEL CO. QUILTS BUSINESS.

The Pontiac (Mich.) Wheel Company has closed down its plant and has discontinued the manufacture of vehicle wheels. With the passing away of the buggy and carriage building trade from Pontiac, the local wheel business, heretofore handled by the Pontiac Wheel Co., was lost. Business had to be sought in the west, where the carriage building industry has been concentrated in the last few years. Shipping their output to such distant points proved unsatisfactory and after weighing the situation carefully the company decided to discontinue the manufacture of wheels. With the closing of the plant upwards of 100 men were laid off.

With the closing of the wheel company's plant, Pontiac loses the last trace of the carriage business which at one time put the city on the map. C. V. Taylor and R. D. Scott were the pioneer carriage builders of the city and before the advent of the automobile, did a flourishing business. When the automobile business opened in Pontiac it soon put the carriage business in the background and one by one the carriage factories suspended operations or moved out of the city, until now the city has not a single one in which carriages or their parts are manufactured.

The directors of the Pontiac Wheel Co. are trying to secure the manufacture of another line of goods in the plant which they hope can be done in the near future.

TOOL FOR REMOVING RIVETS FROM BUGGY BOWS.

This tool is made from an old buggy stub, a piece of flat stock and an old rake tooth, which serves as the punch. To make it, take the old stub and cut it off square, about 2 inches from the collar on the inside. Now take a piece of flat stock, ¼ by 1 inch, and weld it on to the square end of the stub at A. This piece

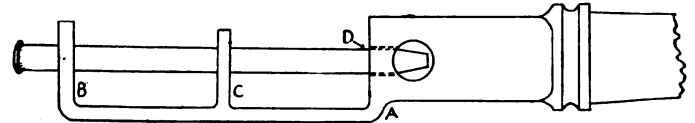

should be about 8 inches long and be bent over at the end, as at B. Then, about the middle of the upright piece, punch a hole and rivet in a piece as at C. Before riveting this piece a hole must of course be punched in it for the rake tooth punch to work in. Now drill a hole in the end of the stub for the punch to enter and, after shaping your rake tooth, your punch is complete. This device will save time and trouble in getting out bow rivets, and after using it the vehicle man will not want to do without it.

COMBINATION SOLID AND AIR TIRE.

Here is a tire with solid rubber tread, and beneath it an air tube. The wheel construction does not materially differ from the ordinary. It will be seen that, in addition to the ordinary bonding rim, around the feloe, there are two extended flanges which are bolted to the feloe. One of these flanges is a permanent fixture, while the other constitutes a detachable rim. These flanges are extended circumferentially, and turn inwards at their outer edges, and in this way a groove is formed to hold the bead. These flanges, therefore, enclose not only the air tube, but also the major portion of the tire, including (which is an important feature) that portion of the tire which, in the case of the ordinary pneumatic, has to withstand the internal pressure of the air tube. Be-

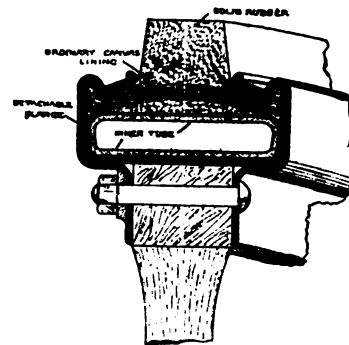

cause the casing of the tire is protected from the outside by the flange and, also through the same instrumentality, from the pressure within, it is claimed that, on this account, the life of the fabric should be greater than the life of a similar fabric under ordinary conditions.

The action of the tire is obvious. On meeting an obstruction, the solid tire is driven back so that it compresses the air tube, and in this way its theoretical action is very similar to an ordinary pneumatic tire. A feature is the formation of the canvas band, which is fashioned like an elongated arch, so that a considerable latitude as regards the movement of the fabric is obtained, with reduced tendencies as regards its stretching. The tire is said to be puncture proof, but if, through a leaky valve the tube should become deflated, the canvas forming the band is provided on its underside with a soft rubber frog, so as to prevent damage to the air tube.

Oilholes on any machine carrying an emery wheel should be kept plugged. Emery grindings will cut out a bearing in a surprisingly short time.

NEW BODY DESIGNS.

The representative of Cooper's Vehicle Journal at the Brussels exhibition made graphic notes of the effective exhibits, and as they supply the advance note of the practice of the best for-

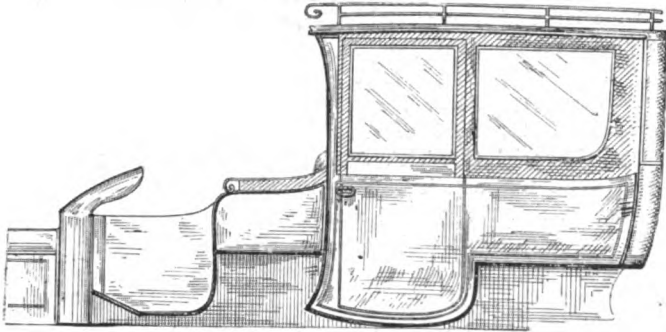

eign builders they should prove of interest to draftsmen in this country as well as being suggestive to those who prefer to modify rather than originate.

The first illustration is a limousine by Labourdette. This carriage was painted light blue with black mouldings, panels picked

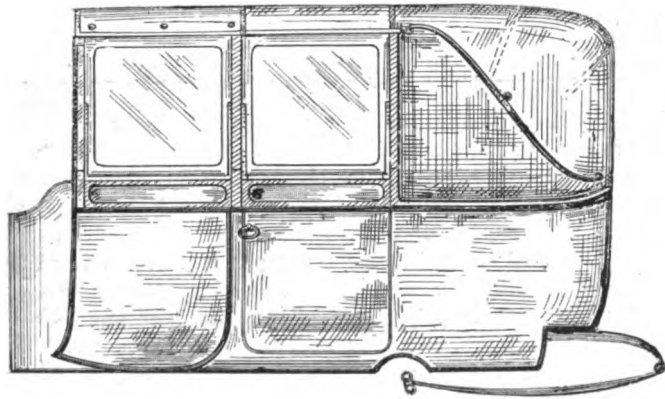

out and fine lined in black. Trimming a light brown rep with pale blue spots. Laces to match.

The next illustration is a cabriolet by Belvalette, with removable front canopy. Its side supports then part in the middle, the front halves folding against the front rail, which is removable,

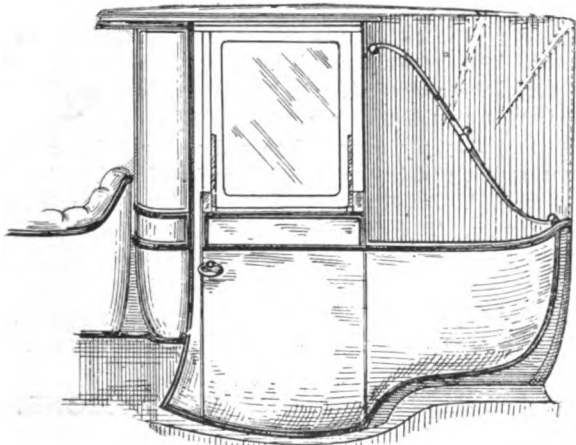

the rear halves folding against the front pillars of the rear door. The top halves of these pillars are also removable. The head can then be folded back in the usual way. A very fine limousine by the same firm is also shown. This was painted brown, with black mouldings, fine-lined orange.

The Dee front landaulette, which is the third illustration, is by Kellner. This is notable for treatment of front and driving seat. The back quarter is also reminiscent of old carriage styles. Body green with plain black mouldings, picked out with black fine lines on the panels.

The limousine following next is from Cottonet & Cie (the successors of Binder) The painting is green with black mouldings picked out in white. Corner pillars as shown are the fashion just at present in Paris. The rounded front panel is unostentatious.

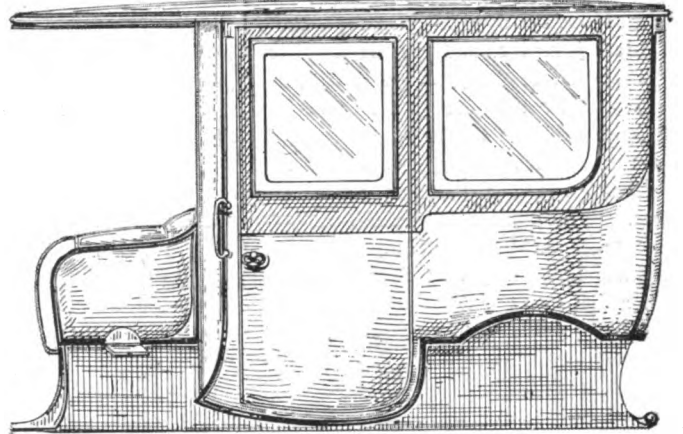

It also gives more seating room while narrowing towards the driving seat.

The next illustration of limousine body design is by Saouchik.

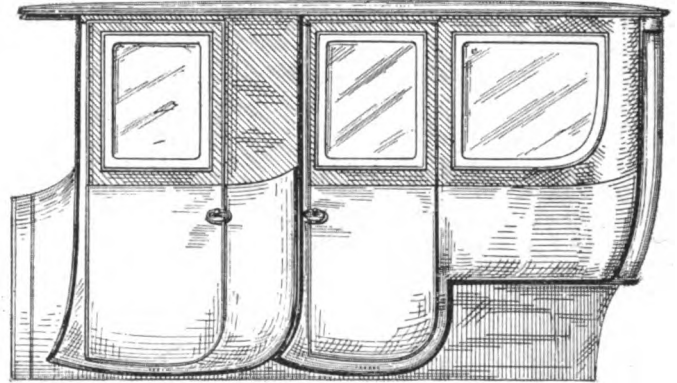

An illustration of a Daimler front seat treatment is shown next in which the scuttle dash is made a feature with narrow doors.

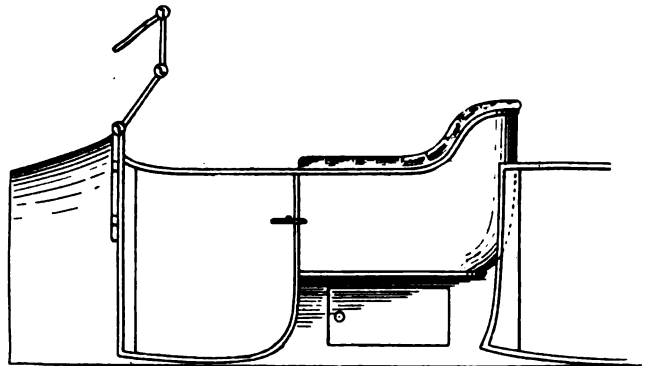

A good detail is the seat locker reached by door shown in seat panel.

HARD SOLDERING.

The following method for hard soldering may be of value and interest to some readers. Take some water and dissolve in it all the cyanide of potassium (Caution—Poison) it will take. Keep this in a glass jar with lid on it. Brighten your joint with a file and make it a good, close fit, then wash with soap and water and a stiff tooth brush to scrub with, and then dip in alcohol and dry with a clean dry cloth. Heat job over spirit lamp until it makes a steam when plunged in solution. Heat and plunge a third time, or you can put it on with a borax brush, if you have your job fastened to asbestos. Apply solution all over job. For the flux use a lump of cyanide.

HISTORY OF COACH BUILDING.

There is established in Paris a museum of the art of the coach-builder and the vehicles of all authentic fashions and periods, with harnesses, costumes, etc., have been gathered by a society organized with this object in view. The examples on display in the museum are appearing in reproduction in some of the foreign technical journals, and in this number we reproduce as well as the character of the print will allow, a diligence of the eighteenth century, and some note on the carriage by M. Louis Vallet, which we translate from the pages of the *Moniteur de la Sellerie*.

Speaking of the diligence and the Berlin, he writes that the confusion between the two vehicles has become complete, as types. In fact, the carriage called a diligence is a Berlin with the front seats lacking, and only the back seats retained, the word diligence indicating that they could be used with more dispatch than a Berlin as a traveling carriage. "I cannot but repeat," he says, "that all carriages of this form, with or without seat, plain, or highly ornamented, are purely and simply diligences."

To give an idea, he continues, of the errors into which pretentious and sottish ignorance can fall, he cites the "ravishing"

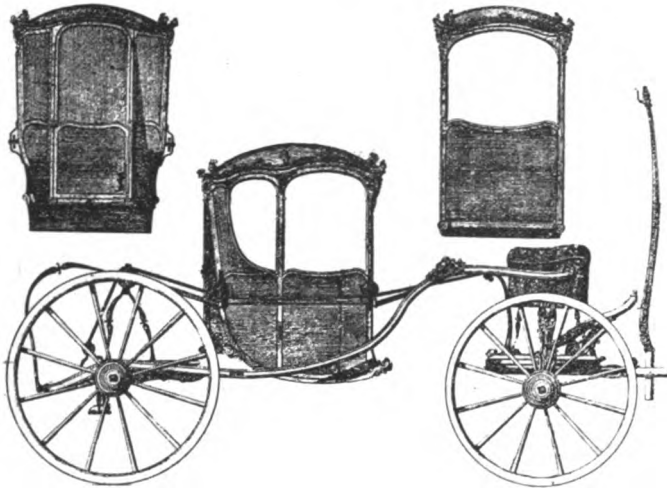

carriage that belonged to Count Armand. This carriage, which was for a time in the Museum of the Decorative Arts, then in the 1900 Exposition, is purely and simply a diligence. In the eighteenth century the difference between a day by day voyage, and the long distance journeys was not great.

So M. Vallet wishes it understood that this coach is without any further argument a diligence. But in 1900, the absence of a seat, and the beautiful, (delicious) ornamentation so befogged the members of the commission of classification that at once they saw a town carriage of the greatest luxury, instead of what it really was, a carriage for traveling. They gravely pronounced the example under consideration "a wedding coach intended to be drawn at the walk only, the groom attending at the coach door on horseback." The writer is in such a state of disgust that he exclaims confectioners could not have rendered a worse judgment. As for himself, he says the way to describe this carriage, "perhaps the most delicious of any in existence," is: "a diligence suspended by thorough braces, and designed for post horses." The public as well as the carriage builder, says the writer, in the commencement of the nineteenth century was much confused between carriages for city use, or traveling use, or public use in towns. Quickly, because of this confusion, the public hacks evolved from the ancient coach, took the name of diligence, and the true two-wheeled post chaise disappeared, giving its name to the diligence as a traveling vehicle. But, says the writer, "this confusion is more apparent than real. All the manuals of coach-building, all technical drawings, show and should show, city Berlins, traveling Berlins, city diligences, also traveling diligences."

True politeness is a talisman of great power to smooth our way along the rugged paths of life

NEW GOODRICH FACTORY IN FRANCE.

The B. F. Goodrich Company has undertaken an elaborate project to supply the European market. It has decided to manufacture tires in France. And for that purpose the European Company, incorporated as the Societe Francaise B. F. Goodrich, has taken the large factory at Colombes, near Paris, recently vacated by the Krieger Gasoline Electric Company. There is a total area of 30,000 square yards in this plant, which means a generous space for large production.

The new factory will be ready in the summer after the machinery of special Goodrich design has been shipped from the United States and installed. The superintendent of works will be Mr. Hauser, and the general manager Mr. Arthur E. Lumsden.

The French factory will supply the whole European market, particularly France, Italy, England and Germany, with automobile pneumatics and the solid tires for motor trucks and carriages. Thus freight charges will be avoided, and also the high duty now paid to bring American tires into most European countries.

For several years the B. F. Goodrich Company has had a selling branch in London and about three years ago opened another one in Paris, first of all to accommodate tourists who could not use tires of French sizes on American cars. Since then business has grown to much greater proportions.

STUDEBAKERS A JERSEY CORPORATION.

With an authorized capital stock of \$45,000,000, the Studebaker Corporation has been chartered in the State of New Jersey. The company was formed to acquire the Studebaker Bros.' Manufacturing Company, of South Bend, Ind., and the Everett-Metzger-Flanders Company, of Detroit. The capital is divided into \$15,000,000 preferred stock, bearing seven per cent accumulated dividends, and \$30,000,000 common stock. The incorporators are supposed to be dummies, being M. Gregg Latimer and John O. Marsh, of New York, and John R. Turner, of Basking Ridge, N. J., clerks in the office of the Corporation Trust Company of New Jersey, the registered agent for the corporation.

"SUCH A SYSTEM."

The Peabody Buggy Co., of Fostoria, Ohio, believes in system. For instance: At one o'clock each day there is a meeting of the foremen of departments with the management. A stenographer is present and takes down every word said, which goes into the records. The freest discussion of everything connected with the interest of the concern is asked for and foremen and journeymen understand that if they are not getting a square deal in any particular that they are expected to call at the office, state their grievance and it will be investigated and if found to be real, it will be corrected. Another feature of this institution is its publicity department. They issue a weekly bulletin to the employes. This contains local news of interest and all are requested to contribute items, either personal or departmental. A similar bulletin is issued and mailed to the traveling men and a monthly publication which goes to the trade throughout the country.

TO SPECIALIZE IN CIRCUS WAGONS.

H. L. Witt & Sons, Morristown, Tenn., if plans materialize, and local co-operation is forthcoming, will specialize in the making of circus wagons. Some few years ago a circus landed there with a large amount of repair work, which was turned over to the Witt shops. The work turned out was satisfactory and an order followed for a new wagon. From this small start a substantial business in the circus line was built and the Witts are now seriously considering the erection of a large plant in which they will manufacture circus wagons almost exclusively. Their present quarters are too small and facilities wholly inadequate.

Carriage and Automobile Painting

LETTERING FOR THE PAINTER.

The full block letter, which is the most usual and useful style of the wagon letterer, partakes much of the character of the Roman letter. It is bold, or "heavy on the face," and is particularly adapted in an extended form for filling a long space with a

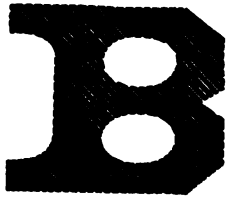

FIG. 1



FIG. 2.

few letters. There are two forms of this letter; the octagon and the round, the octagon (Fig. 1) being considered preferable for fine work, as it possesses a geometrical equilibrium superior to the round; but the latter (Fig. 2) is frequently used on good work to give variety. It will be noticed that these letters differ from those used in type by having all the inside corners curved, which adds to their boldness and solidity. The main difference



FIG. 3.

between these two forms of full block letters is the curving of the exterior outlines of letter, in place of cutting them by angles.

The perfect full-block letter occupies a nearly square space; and, though it never looks well when condensed, it can be extended to an almost unlimited degree without loss of any of its characteristics. On railway cars we frequently see it extended to three times its height; or, in other words, a six-inch letter may be made eighteen inches long and still be plainly distinguishable. Fig. 3 illustrates this feature of extension in the case of the letter E, its length being three and a half times its height. The corners of the octagon letters should be cut off at a very little less angle

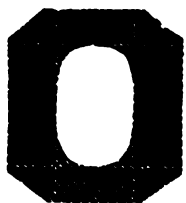

FIG. 4.

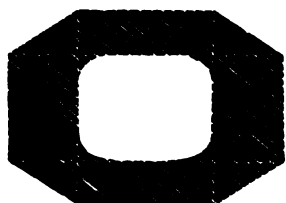

FIG. 5.

than the angle formed by the bars of the letter, as shown in Fig. 4, although, in an extended letter, it may be found preferable to cut the corners from line to line, as shown in Fig. 5.

The half-block letter is virtually a full-block letter with the extensions on cross-bars cut off, and this style of letter is used more than any other on wagon work. It is susceptible of extension, although not to so great a degree as the full block, and it may be condensed to accommodate a large number of letters in one line without injuring their distinctness. The perfect half-block letter fills a square, but, in every style of letter, the M and W always occupy more, and the I and J less space than the others. The sign writer uses a letter similar in shape, but the limbs or body

of the letters are made of the same width throughout, the same as those supplied by the type founder and called by the latter Gothic letters; see the word "Cabriolet," (Fig. 6).

By reference to the type-founders' letters, it will be seen that the letter M is frequently made wider at the top than the M of the painter (see Fig. 7), which makes the letter appear out of proportion or heavy at the top, and the painters' letters are preferable in this respect.

The letter R is made by the painter in several different ways.

CABRIOLET

FIG. 6.

Fig. 8 illustrates two methods of turning the lower limb of this letter, the second one being considered the more "dashy" or off-hand. Some letterers make this limb of the R a perfectly straight bar, inclined at an angle of forty-five degrees, but this form is not to be recommended for beauty. The letters C, G, S, etc., are in print generally cut off at angles, instead of being made square at the extremities, and the cross-bar of the G is carried across, as in Fig. 9, sketch 1, while the wagon letterer forms it as shown in sketch 2.

The Outline Letter—Next in order should be mentioned the outline letter, which is a letter of any style drawn in outline without being "filled in." It is a style well adapted for railway cars. It gives light appearance to the work, and, if well formed and shaded, has an attractive effect. The method employed for making this style is generally as follows: The letter is painted on as usual; that is, "filled in" with paint, but this paint has a few drops of machine or lamp oil added to prevent its drying, after



FIG. 7.

FIG. 8.

FIG. 9.

which it is edged all around with quick-drying color. When this edging is dry, the lamp-oil paint is removed by a thorough washing with soap and water, and the perfect outline letter is left upon the work. This is the most expeditious method of making a correctly formed letter. The letters G and B (Fig. 10) illustrate the characteristics of outline lettering.

The Solid Block Letter or Antique—This letter is made with all, or nearly all, its parts alike (see Fig. 11), and is a style bor-

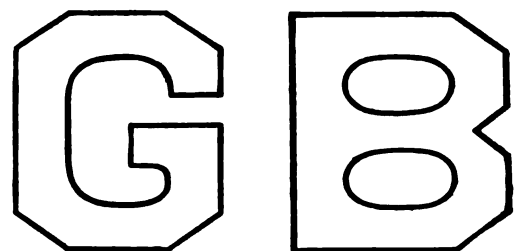

FIG. 10.

rowed from the signwriter and the typefounder, being called by the latter the "Antique." It is very bold, and, when extended, is excellently adapted for filling space. When shaded or blocked, it is very handsome, and it is extensively used in this form on milk wagons in New York City and vicinity. It may be used to advantage on almost any class of wagon work.

Italian Block Letters are used quite extensively on business

wagons, and make an attractive line when neatly executed. See example in Fig. 12.

Italic and Black Slope Letters are frequently employed, but nearly always tend to cheapen the appearance of the work, and consequently are not advisable where a fine piece of execution is desired. Their use is almost exclusively confined to the sign



FIG. 11.

FIG. 12.

painter. It is a singular fact that almost every principal city has a local style of lettering, both for wagon and sign painting. For instance, we find entirely different styles of letters used in Boston and in Philadelphia. Yet all such local styles look well when one is accustomed to seeing them. Years ago the Abbot-Downing Co., of Concord, N. H., introduced a new and very tasteful style of lettering upon their express wagons, and this has been copied



FIG. 13

to some extent by New York letterers. We give a specimen of this style in the word "Press," Fig. 13.

We might enumerate many other styles of ornamental lettering, but as soon as a letter departs from its original simplicity and becomes ornamental or "fancy," all rules for its formation of course, come to an end, and the taste or judgment of the painter takes their place.

PAINTING AUTOMOBILE RADIATORS.

Insufficient radiation, poor working of engine, and not a few other troubles closely connected with the mechanism of the car have lately been credited to the practice of painting the radiator with heavy pigments, and then, perchance, varnishing over all this mass of substance. More than likely the practice above referred to has developed more or less of the insufficient radiation complained of and it can all be obviated by simply going back to a simpler way of painting the part in question.

Liquid asphaltum, thinned a bit, and applied sparingly, in one single coat, is used by many painters with satisfactory results. Lacking color intensity add a little ivory black, beating all together very intimately.

Aluminum bronze thinned with brass or metal lacquer, makes one of the most durable coatings for radiators. Lamp black worked up fine and smooth in wearing body varnish, and applied in a thin body, makes another permanent material for the radiator. The essential thing is to get on a thin coat of some very tough, wearing, durable pigment.

PAINTING THE METAL AUTOMOBILE BODY.

Since the steel automobile body is being used and must be dealt with by the painter it is important to remember that from its surface, before painting, all scale and rust formation should be cleaned off. The sand blast operated by compressed air is perhaps the only real method which gets right down to the seat of the trouble and removes everything inimical to the paint and the other material applied to the surface. In the small shop or garage the sand blast is not, as a rule, available, and lacking this system the painter may, as the next best thing, scour the surface with a wire brush, working it thoroughly around bolt heads,

mouldings, etc., and finishing off with emery cloth. As a matter of fact, this last preparatory method may very well be used upon the aluminum surface. The main consideration in painting the metal surface, whether it be steel or aluminum, is first of all, to get the surface clean, and as near as possible to its condition as it came from the mill. Then in priming use either a thoroughly reliable patent metal primer or a mixture of raw linseed oil, turpentine and some "bodying up" pigment. Giving this primer reasonable time, fetch the finish along in the usual way.

DEVELOPING LAKE PIGMENTS UPON CARRIAGES AND AUTOMOBILES.

The use of such pigments has increased enormously during the past few years both upon horse drawn and horseless vehicles. Probably the increase has been more marked upon the automobile although the popularity of the fine, rich lakes, aglow with brilliancy, has caught the fancy of the carriage and wagon user to an exhilarating extent. Probably this popularity is due in no small degree to the painters who formerly entertained the brief, apparently, that the lake pigments could be handled and placed with becoming charm upon the surface only by a system which, at the minimum, meant an expense out of all proportion to what might be asked as a fair return for the labor and material expended, but who in these later years have found their belief without warrant.

Under the old method of developing lakes upon the carriage or wagon surface there was of necessity very elaborate practices in bringing the surface up to the point of applying the lakes. The lake was then put on as a flat color, and subsequently coated upon with enough glaze coats to produce a wonderful lustre and beauty.

All this, however, has given way to a practice less expensive, but scarcely less effective, although, of course, not worked out so finely in detail. It is understood at the outset, or should be, at any rate, that the lake pigments are not quite so transparent, as we find them in the general market to-day, as they were twenty years ago, and on this score lack somewhat in brilliancy; but if they have deteriorated in this respect, they have grown to be pigments easier handled and with increased covering power.

Now, in brief, what is the generally accepted custom of developing these lake pigments upon surfaces for medium grade work?

Bring the surface up as closely as possible to the color of the lake desired. Mix these preparation coats in raw linseed one part and turpentine seven parts.

Then in an elastic rubbing varnish use the lake, previously thinned with turpentine to the consistency of varnish, making the two—the lake and the varnish—equal in volume. Mix thoroughly, and apply as a color, using a soft flat brush, proportioned in size to the size of the surface, for the work. When dry, lightly knock the gloss down with a tuft of trimmer's hair stock, and flow on, at proper intervals, two coats of the lakes mixed in elastic rubbing varnish in the proportion of one and one-half ounce of pigment to one-eighth gallon of varnish. Over this, one coat of pale rubbing varnish, surfaced in due time fine and uniform, then finish with a pale elastic body finishing varnish.

FILLER FOR HARDWOOD.

Make a very thick paste of boiled linseed oil and powdered starch; add a little japan and then with oil of turpentine reduce to working consistency. For dark ash and chestnut add a little raw sienna; for walnut, add burnt umber and a little Venetian red. For white oak or white ash no color is required, for other woods, use enough color to cover the white of the starch. Apply with a brush or rag; let stand a few minutes, then sandpaper.

Captain Bellanger of the French army corps has established a new speed record by flying a distance of one hundred miles across country in 70 minutes.

PAINTING AND VARNISHING.

Mr. Morrow, of the Masury establishment, not long since spoke a few words on the always interesting subject which is head-lined. The Philadelphia wagon builders were the hosts. We reprint some of the more prominent of the speaker's observations:

My keynote is purity. There has never been a time in the whole history of painting when there were so many substitutes, so many would-be leads, so many would-be oils, so many would-be turpentines, as there are to-day, and these "would-bes" never made so much noise, never made such strong claims, as they do to-day, and yet, gentlemen, I do not hesitate to say to you in the strongest possible way that there is no substitute for linseed oil or turpentine in painting, nor for the hard fossil gums in varnishes.

We can take no chances on the finish of our carriage or wagon. The surface has got to stand sun and rain, snow and sleet, the mud and grit of the streets, and the strain and stress of load as well as the claim of contraction and expansion from heat and cold.

It is a general idea that carriages and wagons are not painted in as durable a manner as they were years ago. This is only partly true, and in so far as it is true it is due to two reasons—first, the desire for hurry, and second, the use of substitutes. If we stick to pure linseed oil and pure lead for our priming coats, we will protect in the surest way the wood from moisture, and the permanency of succeeding coats is assured as far as the priming coat is concerned. Our foundation must be good, or any work done on top will be worthless.

After the priming we come to the filling, or surfacing. The object of this is, of course, to get a hard, smooth, level surface for the color and varnish. The practice usually is to give two coats of keg lead thinned with varying proportions of linseed oil and turpentine. If we use pure oil and pure turpentine we will have no trouble. Most of the substitutes for turpentine on the market are made from petroleum products containing more or less proportions of wood turpentine or the regular spirits of turpentine. The genuine spirits of turpentine is, as you all know, the product of the pine tree. By a method of distillation they distill everything out of the wood, and by a process of refining get the turpentine out of the distillate; but you can see at once how different this process is from that which gives us the true spirits of turpentine, and while it is true that by their process of refining they finally get a chemically pure turpentine, at the same time it is different. The odor is different, being very disagreeable and irritating to eyes and nose.

The substitutes containing any proportion of petroleum or rosin are not to be relied upon in carriage or wagon painting. Pure spirits of turpentine does not completely evaporate from the paint, or whatever coating it may be used in, and I think this is one of its important functions. I know that a good many people, even among painters, think that the only function of turpentine is that of being thinner, which brings the paste paint to a brushing consistency, and its peculiarity of slow evaporation, allowing the painter time to brush out the coat; but this is not all. Turpentine does not completely leave the paint. If you evaporate a portion of pure spirits of turpentine on a shallow dish, for instance, when the evaporation is complete you will find a gummy residue left. This is not common resin, as some suppose, but it is an oxidized product which has a distinct value in the paint film when dry.

The power of turpentine to absorb oxygen plays a very important part in painting, and is very little understood. The average painter knows nothing about it. No substitute has this power of absorbing oxygen. Some evaporate completely like benzine; others only partially evaporate, leaving an oily, greasy residue of a greater or lesser proportion, according to the make. Now, this oil or greasy residue, which is surely left in the paint film may be very small, but it is bound to have an effect upon the finished

job—not only one effect, but many. It is likely to cause cracking, flaking, sinking in and final perishing. Nor is the painter always to blame; the guilty one may be the color grinder, who buys or has made for him a cheap japan to grind his colors in; it may be the varnish maker from whom you buy your japan, mixing or rubbing varnish, as the case may be, or it may be the storekeeper from whom you buy your turpentine.

The same remarks almost apply to substitutes for linseed oil. Its characteristic property is its power to dry. There are a few other oils, such as sunflower oil, walnut oil, poppy oil, and some others have this property in some slight degree, but none to compare with linseed oil, and as a rule they are too expensive to use as a substitute, even if they were of equal value as drying oils, so that for substitutes we are forced to the non-drying oils, such as resin oil and petroleum. In order to make these dry they must be treated with dryers, but they show the same objection as I have described in the substitute turpentines.

In this connection I must not fail to mention tung oil, or Chinese wood oil, as it is commonly called. I believe this oil is destined to play a very important part in the painting and varnishing; in fact, it does to-day, but not as a substitute for linseed oil. This oil was introduced to the trade about ten years ago, and has gradually come into general use among varnish manufacturers, not so much in carriage varnishes as in furniture and agricultural implements. There is no question but that it has many good points, but manufacturers will jump at conclusions, its very good properties will be accepted and made much of, and they will push it to the front, forgetting or ignoring any faults it may have instead of waiting until it has been tried and demonstrated in every case that it is suitable for the work. I do not class tung oil as a substitute; it is a new thing, and in places has proved itself to possess quality of merit.

Varnish, as you all know, is a combination of gum, oil, turpentine and some other solvent or thinner, together with the proper amount and kind of dryer. The gum is sometimes referred to as copal. This gum is equally important as the oil or turpentine. It would take too long to explain all the kinds of varieties of copals used in varnish making, but Kauri holds the first place. While different varnish makers profess to be able by their particular process to obtain perfect results with other varieties, all agree that Kauri is the safest. This mixes and holds in better combination with paint or color than any of the others, and I think sometimes the cause of failure in your finished carriage or wagon is due to the fact that the right kind of gum has not been used in the manufacture of the varnish that enters into some of the coats.

There have been a great number of "systems" devised for the purpose of hastening the work of painting a carriage or wagon. Many of these have been found to give satisfactory results. The only remark I have to make in regard to these is that the pigment, of whatever nature, should be held together with pure oil, pure turpentine and the proper amount and kind of japan dryer or varnish, as the case may be.

The important part of painting is the nailing or fastening on of the coats, the first coat being just as important as the last. The nails and screws are the oils, the japans or dryers. The varnishes and thinners used in making paints should be of the best, and if bought from reliable houses who have made a study of the different materials, you should feel assured that your work will be all that is demanded from it.

BUYS THE CROZIER FACTORY.

G. W. Millikan, manufacturer of automobile bows in Montpelier, Ind., is removing his factory to Muncie, in the same state. He has purchased the building formerly occupied by the Crozier Automobile Works and expects to commence operations in the new location within a couple of weeks.

A TALK ON TIRE SETTING.

I would like to give your readers my way of setting tires, says H. C. Deible, in the *American Blacksmith*: We hardly ever set less than three sets at a time—from three to six, and mainly four. That makes a nice day's work for a smith and helper. To begin with, we lay the four sets of tires on the floor, side by side, run a wheel over front and hind to get length, add three times the thickness of tire, cut off, straighten edgewise, and run through bender. I am always very careful to get them bent round and true. Now I take my tire wheel or traveler and run all the wheels, mark them hind and front from one to eight, and also mark the size of each wheel and the number on the tire wheel. Our tire wheel is made of a small circular saw; the handle is of wood with slot

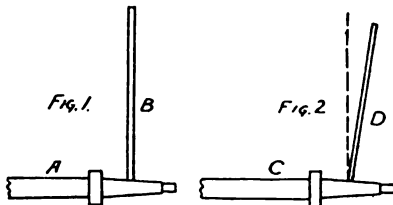

sawed into one end with fine rip saw, and riveted through center of wheel, so that it runs perfectly true. The engraving shows the tire wheel. In the measurements, No. 1 is a groove made with a fine file, and is the starting point; No. 2 is front wheel measurements, and No. 3 hind wheel measurements. Now we are ready to begin welding tire. The wheels are all run and set out near the tire stone, No. 1 first, then No. 2 and so on up to No. 8. First, I true up the ends, then turn tire and mark exact length. Then I heat, cut off, scarf and weld. When the tires are all welded, I lay them down to heat on a foundation of heavy irons, so that they

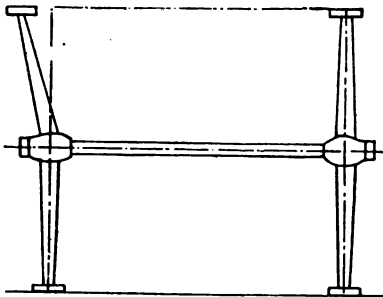

rest in four places. I build a good fire and heat them hot enough to cause them to drop on easily, without hammering or sledging. Then we lift them out of the fire with long-handled tongs, drop them on wheels and cool them, using hose and city water for the cooling. I give heavy tires, such as $1\frac{5}{8}$ inches by $\frac{3}{8}$ inches, of $1\frac{3}{4}$ inches by $\frac{3}{4}$ inch, from 3-16 to $\frac{1}{4}$ inch draw. That, with heat from weld, makes $\frac{3}{8}$ to 7-16 of an inch draw. I have no trouble in giving new wheels the proper dish. We give heavy wheels from $\frac{1}{2}$ to $\frac{5}{8}$ inch dish. We use $\frac{1}{2}$ -inch Stayer hubs. I believe that I set more than one hundred sets of tires, new and old, each year for thirty-five years.

WILL ERECT AND OWN BUILDING.

Definite steps to further the organization's plans to erect a building for exposition purposes were taken at the regular meeting of the Peoria (Ill.) Implement, Vehicle and Hardware Club at its regular monthly meeting at the Creve Coeur Club February 18. President W. O. Ireland named a committee of five to confer with the industrial committee of the Chamber of Commerce at a meeting which was held Monday evening, February 27.

Implement dealers in Illinois, disgruntled at the State Board of Agriculture because of its alleged lack of interest in according state dealers good exhibition places at the state fair, and because of alleged favors shown Chicago mail order houses, have voted to organize for an implement and vehicle show at Peoria.

OBITUARY

William U. Jube, head of John P. Jube & Co., carriage materials of New York, died January 21 at his home in East Orange, N. J., from a complication of diseases. He was 74 years old and the eldest son of John P. Jube, who founded the New York business.

Christian Gentes, for half a century engaged in the manufacture of wagons and carriages in Peoria, Ill., died February 7, aged 75 years. He was born in Woldersheim, Bavaria, Germany, and came to the United States in 1854. He worked at his trade for some years as wagon and carriage builder and later became a member of the firm of Folz & Gentes, which was succeeded by the present firm of C. Gentes & Son. He is survived by one son, Robert, the business partner, and two daughters.

E. W. Copeland, founder of the Fourth street wagon works at Clinton, Iowa, died at Seattle on January 4.

Geo. H. Fernald, president of the Fernald Manufacturing Co., of North East, Pa., died at Denver, Colo., January 24, after an illness of a few days. The deceased was born in Ohio July 8, 1864, but he lived the greater part of his life at North East, Pa. He organized the Fernald Manufacturing Company in 1896. The deceased had a wide circle of friends and acquaintances among carriage manufacturers and jobbers, and was a familiar figure at vehicle manufacturers' conventions. During the past five years Mr. Fernald spent most of his time in Denver, where he was interested in the automobile trade as president of the Fernald Automobile Company.

John Sticker died in a hospital in Greensboro, N. C., February 9. He was a traveling salesman in the employ of the Brockway Wagon Company, of Homer, N. Y., and was one of the oldest salesmen on the road. While on the southern trip for his firm he was taken ill at Greensboro, N. C., and went to the hospital, where he died. Mr. Sticker was born in Pennsylvania 70 years ago. Surviving him are three daughters and one brother. The remains were taken to Rome, N. Y., for burial.

Frank Slosson, secretary of Bain Wagon Co., Kenosha, Wis., passed away February 4. He was born in Richmond, Mass., in 1847. A week before his death he had been operated upon for a perforation of the wall of the stomach and although he made a brave fight for life he could not survive. He resided in Kenosha more than 40 years.

Charles G. Bartsch, Jr., son of a carriage builder in Brooklyn, N. Y., died in a cell as result of a blood clot on brain caused by fractured skull. He had been attacked and robbed when found by police, who acted on supposition that victim was intoxicated.

John Reznor, Rochester, N. Y., former carriage builder, died February 23, by shooting himself. He was cleaning a revolver and the doubt as to accident or suicide is unresolved.

Joseph O. Hutton, a well known representative of C. Schrack & Co., of Philadelphia, died at his residence in Germantown, Philadelphia, recently.

Henry Walschmidt, of Columbus, Ohio, died February 3, aged 51 years. A widow, two sons and five daughters survive.

Archibald McKinnon, of A. J. & A. McKinnon, Crookston, Montana, large implement and vehicle concern, is dead.

John B. Shaw, South Connellsville, Pa., an ex-wagon maker, is dead at the age of 90. His second wife survives.

George Ironside, forty years a wagon maker, died February 12. Wife and two children survive.

GRAMM ELARGEMENT AGAIN NECESSARY.

Although the Gramm Motor Car Co. only last month removed from Bowling Green, Ohio, and took possession of its new and larger plant at Lima, Ohio, the necessity for more room already has become apparent. As a result, plans for an addition now are being drawn.

Description of Fashion Plates

THE PIERCE-ARROW FIVE-TON TRUCK.

(Illustrated on Page 343.)

When a company that has been manufacturing passenger cars for ten years engages in the making of trucks there is bound to be more than ordinary interest in what that truck will be. That interest is added to when the company is one whose standing in the industry is of the highest character. It is prepared to market a completed vehicle of five tons capacity and the announcements made show that this car will bring to the American market a number of fresh ideas and a novelty in truck practise on this side of the water, the worm and worm wheel for the final drive.

The motor of the new Pierce-Arrow truck is of the four cylinder vertical type, the cylinders being cast in pairs. It has a bore of $4\frac{7}{8}$ inches and a stroke of 6 inches, giving a nominal rating of 38 horsepower. The general design of this motor is very much like that of the Pierce-Arrow passenger cars, although the construction, in every detail, is much heavier and fitted for truck necessity.

Many reasons are advanced for the use of the worm gear, one of the most important being the far greater reduction necessary for a truck than for a touring car. In the case of the truck a reduction of seven or eight to one is needed and this makes the bevel gear impracticable because of the great size that would be required. The problem of a compound gear drive in the rear axle is not an inviting one and many engineers consider the use of a jack shaft with chains and sprockets a make-shift arrangement. For this reason alone the worm drive would present alluring possibilities. Its simplicity of construction as compared with other types of final drive for truck purposes is not the only point that commends the worm drive, however. It has been found by repeated tests under all conditions of service that it gives an efficiency of 95 per cent against 80 to 85 per cent for the combined jack shaft, sprocket and chain drive. Another factor that must be reckoned with in the worm drive is that it is absolutely silent in operation and not only that but it has a decided tendency to induce quietness in other construction members.

The rear axle of the Pierce-Arrow truck is of the full floating type. The front axle is a solid one-piece, drop forging of I-beam section made of special heat treated steel. It is perfectly straight. The frame of the truck is of pressed, cold-rolled special carbon manganese steel, heat treated after forming. It is of the channel section type.

Several types of bodies are provided but the expectation is that it will be necessary to meet the special requirements of the various businesses which will use trucks of 5-ton capacity.

In placing the driver's seat behind the motor instead of over it the European practise in this respect has been adhered to. By placing the seat where it is there is less weight on the front wheels which makes driving an easier task, the motor is much more accessible, the control levers are simpler and more direct and access to the driver's seat is more direct.

The decision to adopt the design by which the driver's seat is placed back of the motor was reached partly through the experience of several companies to which experimental trucks were loaned. One of the lessons learned then was that on trips where a part of the load is delivered en route the proportion of weight on the front wheels increased rapidly as that on the rear wheels decreased. Toward the end of the trip the steering, accordingly, would remain as hard as when the full load was on while the traction would be decided less, owing to the lack of weight on the rear wheels.

So far as tire wear is concerned the matter of a greater load on the rear wheels than on the front is taken care of simply by the

equipment of the rear wheels with tires larger than would otherwise be used.

ALCO THREE-TON TRUCK.

(Illustrated on Page 343.)

The American Locomotive Co. is making a strong bid for commercial work, and we show one of the 3-ton trucks made by the company. In the February issue we fully described the exhibit of the company in Madison Square Garden show, which makes more than mention of this truck unnecessary.

LULL BUGGIES.

(Illustrated on Pages 344-345.)

The two examples of the buggy work being turned out by the Lull Carriage Co., of Kalamazoo, Mich., are the job, without and with the top. The feature is the treatment of seat, which is, of the so-called twin auto style, 18 inches deep, dug-out panels. The painting is black and lake, the gear and the dug out parts of panels being in lake, the other parts black. It makes a striking looking job, well calculated to attract dealers' sales.

FLINT WAGON WORKS TRUSTEESHIP AT AN END.

The Flint (Mich.) Wagon Works, which has been under the control of a board of directors representing the banking creditors of the concern, has been transferred back to the original board of directors.

The company's announcement indicates that the entire indebtedness of \$518,000, with interest, has been paid, and consequently the banking concerns withdrew their representatives as trustees. The company announces that the business outlook for this year is the brightest in its history. The entire automobile output of the factory, amounting to about 1,200 cars, has been sold, and the demand for other vehicles indicates a prosperous year in that line.

Officers of the company say that the general depression that existed last summer in the financial end of the automobile business was responsible for the embarrassment. The difficulties were not due to any falling off in business or other causes, but simply because they chanced to be creatures of the same circumstances that caused a general readjustment of the finances in automobile circles. When the depression occurred the wagon works was not in a position to meet a demand of \$100,000 that was made upon it by a Chicago bank, which held the company's note for that amount. The company's inability to meet that obligation impaired its credit to the extent that all of the creditors joined in attempting to obtain a settlement of their claims. Out of these demands, which were presented at a meeting of the representatives of the banking concerns and representatives of the Wagon Works last fall, grew the temporary working arrangement that has just ceased by the payment of all the outstanding obligations of the company.

NEW AUTO COMPANY FOR CLEVELAND.

Through a deal consummated in February Cleveland gets an automobile factory. The company, to be known as the Croxton Motor Co., has been incorporated under the laws of Ohio for \$250,000, and will begin soon the construction of taxicabs, motor trucks, and pleasure cars. The company is an outgrowth of the Croxton-Keeton Motor Car Co., of Massillon. The plant to be occupied is a five-story brick structure formerly occupied by the Baker Motor Vehicle Co. H. A. Croxton, of Massillon, has been chosen president and general manager of the new company and will remove to Cleveland at once, as will H. D. Michaels, of New York, who is heavily interested in the company. J. O. Stoltz, of New York, will be vice-president.

RECENTLY GRANTED PATENTS OF INTEREST TO THE VEHICLE TRADE.

- 965,551—Vehicle Lamp. Irving H. Atwood, Amesbury, Mass.
 965,681—Wheel. Samuel Bagnell, Hankinson, Miss.
 965,272—Vehicle Fender. Samuel Baxter, Staleybridge, England.
 965,281—Pneumatic Tire. John Corwin, Chicago, Ill.
 965,158—Support for Carriage Lamps. Hiram L. Cowles, Princeton, Minn.
 965,288—Front Automobile Axle. Jew Garlick, Paterson, N. J.
 965,705—Means for Securing Wheels to Axles. Harry C. Grant, Bayonne, N. J.
 965,579—Vehicle Spring. Karl W. Hammer and C. L. Crist, Dayton, Ohio.
 965,459—Combined Buggy Top and Rein and Robe Holder. Allen Hitt, Gustine, Texas.
 965,191—Elliptic Spring. Harry Jeffrey, Louisville, Ky.
 965,715—Demountable Rim for Automobiles. Charles Johnson, Buffalo, N. Y.
 965,478—Driving and Steering Mechanism for Vehicles. Daniel A. Miller, East St. Louis, Ill.
 965,313—Sled Runner Attachment for Vehicle Wheels. Jacob M. Mittleman, Philadelphia, Pa.
 965,539—Automobile Wheel. Charles Rasmussen, assignor of one-half to P. W. Steinbeck, New Haven, Conn.
 965,747—Automatic Wagon Brake. Engene F. Rickerson, Butler, Ga.
 965,233—Storm Front for Vehicles. George W. Scott, assignor to the Star Storm Front Company, Troy, O.
 965,341—Tightening Tires and Spokes in Fellies. Alfred B. Smith, near Topeka, Kan.
 965,492—Metallic Wheel. Samuel Strobl, Chicago, Ill.
 965,419—Sleigh Brake and Stop. Henry F. Troh, Glenwood, Wash.
 965,345—Draft Equalizer. Harley O. Turner, assignor of one-half to E. G. Bock, Lebanon, Kas.
 966,290—Shock Absorber. Dolvan B. Akard, San Francisco, Cal.
 965,847—Vehicle Wheel Rim. John M. Alderfer, Sharon Center, Ohio.
 966,296—Spring Wheel. Clarence J. Bailey and W. Jansen, Dryden, N. Y.
 966,073—Differential Axle Device. Arnold Becker, Santa Barbara, Cal.
 965,864—Vehicle Top. George F. Brewster, Chandler, Okla.
 965,986—Carriage Curtain Fastener. Fred S. Carr, Brookline, assignor to Carr Fastener Company, Boston, Mass.
 966,082—Non-skidding Device. Lewis D. Christie, Bridgeport, Conn.
 965,990—Wagon Reach. Daniel Cosner, Lenore, Idaho.
 965,994—Automobile Running Gear. John Eckhard, Boston, Mass.
 966,006—Sled. Wellington Gillaspie, Elizabeth, W. Va.
 966,114—Draft Gear. Thomas L. McKeen, Easton, Pa.
 966,037—Carriage Top. Wm. C. Mitchell and G. A. Harrison, La Fayette, Ind.
 966,043—Vehicle Step. George P. H. Nelson, Lake Providence, La.
 966,117—Vehicle Pole. John N. O'Neill, Georgetown, Ont., Canada.
 966,401—Buggy Shackie. Charles F. Perry, Harlingen, assignor of one-half to W. F. Hutchinson, Olney, Texas.
 966,062—Portable Wagon Dump and Grain Elevator. Herman S. Swanson, Shenandoah, Ind.
 966,785—Automobile Windshield. Frank W. Aurlg, assignor to T. S. Shibe, Philadelphia, Pa.
 966,994—Detachable Wheel Rim. Thomas W. Broomell, assignor of one-third to G. A. Lichtenberger and one-third to C. H. Bear, York, Pa.
 966,519—Motor Vehicle. Alanson P. Brush, Detroit, Mich.
 966,656—Draft Gearing. John F. Courson, Pitcairn, Pa.
 967,006—Axle Clutch. Robert C. Feile, Reedsville, Wis.
 966,437—Coupling for Whiffletrees. Ferdinand Fellhauer, Osborn, Mo.
 966,461—Spoke Extractor. Joseph Messinger, Philadelphia, Pa.
 966,577—Wheel Mount and Axle. George D. Munsing, Newark, N. J.
 966,586—Automobile Front Axle with Drive. Andrew O. Nordquist, A. R. Nordquist and C. W. Nordquist, Minneapolis, Minn.
 967,052—Vehicle Shaft Attachment. Henry M. Powell, Omaha, Ga.
 967,065—Cushion Tire for Vehicle Wheels. Leo L. Savoie, New Orleans, La.
 966,776—Whip Socket and Lock. Carl C. Shaw, Cynthiana, Ind.
 967,073—Sleigh. Stephen Springett, Owosso, Michigan.
 966,868—Shock Absorber. Napoleon St. Francis, Chicopee Falls, Mass.,
 966,722—Brake for Road Vehicles. Wm. H. Weight, Bishopton, Bristol England.
 966,510—Brace for Auxiliary Vehicle Springs. Wm. Young, assignor to Supplementary Spiral Spring Company, St. Louis, Mo.
 967,100—Traction Device for Automobiles. Charles F. Zillmer and G. A. Strohhaecker, Milwaukee, Wis.
 967,305—Vehicle Top Bow Holder. Clarence L. Blair, San Francisco, Cal., assignor by mesne assignments, to Auto Specialties Manufacturing Company.
 967,154—Dump Wagon. Andrew C. Baker, Albion, Mich.
 967,155—Doubletree Attachment. Wm. R. Ball, Bryan, Texas.
 967,599—Demountable Rim for Vehicle Wheels. Frederic N. Bendelari, Cleveland, Ohio.
 967,722—Driving Gear for Motor Vehicles. Wm. Bushey, Vincennes, Indiana.
 967,723—Wheel Attachment. John C. Butterfield, Belmont, Iowa.
 967,728—Vehicle Gearing. John J. Charley, Kew, Victoria, Australia.
 967,170—Running Board for Automobiles. Howard E. Coffin, assignor to Chalmers-Detroit Motor Company, Detroit, Mich.
 967,740—Vehicle Wheel. George Dorffel, Fruitvale, Cal.
 967,506—Vehicle Tire. Edward W. and P. J. Evans, Waltham, Mass.
 967,181—End-Gate. Wilhelm A. Giermann, Blencoe, Iowa.
 967,779—Tire Protector. Charles W. Jasmer, Marshfield, Wis.
 967,643—Vehicle Tire. John A. Keller, assignor to L. Shubert, New York, N. Y.
 967,786—Automobile Transmission Gearing. Frank F. Kohler, South Zanesville, Ohio.
 967,529—Dirigible Lamp for Motor Vehicles. Frank W. Larcher, assignor to A. H. Lent, Oakland, Cal.
 967,205—Pivot Light. Alfred H. Lent, Oakland, Cal.
 967,553—Spring Wheel for Vehicles. Charles F. Quick, Yonkers, N.Y.
 967,457—Tire Armor. Paul M. Stephen, San Francisco, Cal.
 967,473—Breaking Cart. John F. Whitman, Belvidere, Ill.

- 967,249—Spring Tire for Wheels. Silvio A. Schewczik, Vienna, Austria-Hungary.
 967,248—Automobile Radiator. Adam Schepper and E. Covert, Bay City, Mich.
 967,698—Running Gear for Motor Vehicles. Horace E. Wray, Ukiah, Cal.
 Copies of the above patents may be obtained for fifteen cents each by addressing John A. Saul, solicitor of patents, Fendall Building, Washington, D. C.

RECENTLY EXPIRED PATENTS OF INTEREST TO THE VEHICLE TRADE.

Patents Expired January 9, 1911.

- 512,459—Wheel. Jonah Turner, Blendville, Mo.
 512,501—Vehicle Spring. George T. Chapman, New York, N. Y.
 512,502—Vehicle Spring. George T. Chapman, New York, N. Y.
 512,666—Vehicle Hub. Barnhard Schad, Batavia, N. Y.

Patents Expired January 16, 1911.

- 512,775—Running Gear for Vehicles. Charles A. Warren, Columbus, O.

Patents Expired January 23, 1911.

- 513,162—Rein Support. Frank E. Van Loan, Rome, Pa.
 513,394—Vehicle Brake. Elijah Hays, Warsaw, Ind.

Patents Expired January 30, 1911.

- 513,578—Folding Vehicle Top. Salem E. Klerolf, Jackson, Tenn.
 513,739—Vehicle Top. Edwin D. Stevenson, Wadsworth, Ohio.
 513,765—Oscillating Device for Vehicles. Edward M. Crane, Oshkosh, Wisconsin.

Patents Expired February 6, 1911.

- 514,067—Wagon Body. Charles A. Erickson, Red Wing, Minn.
 514,219—Holdback for Vehicles. William Finlay, Schoolcraft, Mich.
 514,347—Vehicle Top. Frederick Buob, Cincinnati, Ohio.

PROFIT SHARING.

In January every employe of the Lilley Carriage Company, Memphis, Tenn., received a check of 3½ per cent of the net earnings of the company, based on his earning capacity, for a period of twelve months' service, in compliance with the company's rule under its plan of co-operation with its mechanics. This plan of co-operation was introduced some four years ago by Owen Lilly, Sr., president and manager of the Lilly Carriage Company, with the full consent of every member of his directory board. Since the inauguration of this scheme, the company's business has steadily increased every year. The plan is simple and applies to every mechanic, black as well as white, who has attained a twelve months' continuous service with the company. The highest prevailing wage is paid to every man in proportion to his worth as a mechanic.

PATENT MIX-UP

A carriage evener invented by L. and Duncan McGregor, brothers, of Duluth, Minn., has caused a lot of litigation. In a decision handed down by Judge Dibell it was decided that Miles T. Frink and the Alvarado Manufacturing Company own the rights to the patent. After inventing the evener, the McGregors applied for a patent, but being without money, entered into an agreement with N. H. Smith to form a company capitalized at \$25,000 in 2,500 shares of \$10 each. They were to deliver the patent to the company. They finally refused to turn over the patent and later assigned their rights to Miles T. Frink for a valuable consideration. Frink then assigned the patent to the Alvarado Company.

THESE WERE THE SUBJECTS.

The large and very successful meeting of the Retail Dealers' Hardware and Implement Association, Texas Hardware Jobbers' Association, and the Southwestern Harness and Saddlery Manufacturers' Association in Houston, February 14, discussed the following subjects: National Federation; Cost Accounting; Our Insurance Exchange; Should Dealers Buy from Manufacturers Who Sell to Catalogue Houses?; Competition from Jobbers; A Peddlers' Law; Parcels Post and Its Effect; Price Cutting Competition Among Dealers; Express Rates; Retail Advertising; Charity Advertising. A very successful exhibition was a part of the show.

Trade News From Near and Far

BUSINESS CHANGES.

A. H. Hart, Winona, Minn., has purchased the plant of the St. Charles Wagon Co.

Gould Bros. have purchased the stock of vehicles, etc., of F. J. Allender, in Sterling, Kas.

A. J. Hoehne has disposed of his stock of vehicles, etc., in Osmond, Neb., to George Senift.

W. O. Day, Brodhead, Wis., wagon maker, sold an interest in the business to Peter Pearson.

Wayne Munn has purchased the stock of vehicles, etc., of Walter Peterson, in Randolph, Kas.

Grant Anderson has disposed of his stock of buggies, etc., in Alpena, S. D., to H. A. Munson.

M. R. LaRue has purchased the stock of carriages, etc., of Billington & Son, Bancroft, S. D.

James Martinek has purchased the stock of buggies, etc., of Joseph Novak, of Howells, Neb.

Shingledecker & Johnson have sold out their stock of vehicles, etc., in Audubon, Ia., to James Law.

J. W. Boyett purchased the wagon and blacksmithing business of John Morgan at Kirbyville, Tex.

J. V. Palmer has purchased the implement and vehicle business of E. W. Campbell, in Adams, Neb.

Gardner Bros. have sold out their stock of vehicles and hardware in Osceola, Ia., to A. M. Tate.

C. Y. White & Co. have disposed of their stock of vehicles, etc., in Cave City, Ky., to Duke & Ferris.

The Ohio Steel Wagon Co., Wapakoneta, Ohio, has changed its name to the Thompson-Brese Co.

Desmond Bros. have succeeded to the stock of vehicles, etc., of the late P. A. Desmond, in Emery, S. D.

C. R. Helber has purchased a half interest in the stock of vehicles, etc., of C. L. Rickard, in Alda, Neb.

Frank Miller is discontinuing the handling of vehicles in Prescott, Kas., but continues in the hardware line.

Eugene Henderson has purchased the stock of vehicles and hardware of Henry Ahlborn, in Lebanon, Kas.

N. Johannes & Sons have disposed of their stock of vehicles, etc., in Rich Hill, Mo., to Hart, Brundage & Co.

Castillo & Copeland have succeeded to the vehicle and implement business of Thos. Copeland, in Blanchard, Iowa.

Geo. Fletcher & Son have disposed of their stock of vehicles and implements in Neligh, Neb., to Wesley E. Bitney.

T. E. Barnes & Son have purchased the implement and buggy business of J. P. Wolts & Son, in Grand Junction, Iowa.

George W. Donaldson bought out the interest of R. M. Robinson in Robinson-Donaldson Buggy Co., at Vincennes, Ind.

Haugen Bros. have succeeded N. N. Haugen & Son in the vehicle and implement business in Pelican Rapids, Minn.

E. Murry & Co., dealers in implements and buggies at Jacksonville, Ill., have dissolved. J. T. Sample and his son succeed.

T. I. Mitchell has purchased the implement business of T. P. Phillips & Son, in Mount Vernon, Ia., and handles vehicles.

The control of the Krit Motor Car Co., of Detroit, has passed to a syndicate headed by Walter S. Russel, of the Russel Motor Axle Co. The capital of the company is \$250,000.

The Keller wagon factory, Joplin, Mo., 20 acres of land and complete machinery and equipment of the plant were sold at auction, W. J. Leffen bidding in the property for \$40,000.

The Miller Mfg. Co., Monroe, Wis., manufacturers of wagons, carriages, etc., changed name to Monroe Mfg. Co., and increased

capital to \$50,000. An addition will be erected to the factory building. J. F. Muerman is president, Samuel Iseley, vice-president, J. C. Gillum, secretary; Jacob Steussey, treasurer.

E. H. Stulb has bought the interest of J. Stulb in the C. Schrack & Company varnish concern at Philadelphia, Pa. Mr. Stulb will continue the business personally under the firm name.

The Halley carriage factory at Tecumseh, Mich., which was conducted for years by John R. Hailey, will be reopened by his son, Frank J. Hailey, who was formerly general manager of the factory. It is nearly fifty years ago since the elder Hailey engaged in the carriage industry.

W. B. Griffin, with the Winona (Minn.) Carriage Company, holding position of business manager, will close his connection with that concern. William E. Muir, one of the younger officials of the concern, who has been serving in the capacity of secretary, will succeed Mr. Griffin. It is expected Mr. Muir will also retain the secretaryship. E. S. Davis will become active superintendent.

Lanpher Bros., Carthage, Mo., purchased the business of the Mallory Carriage Works, owned by J. E. Mallory and E. H. Young. Lanpher Bros. have jointly occupied the building with Mallory & White, being engaged in the manufacture and repair of automobiles. The new firm will incorporate for \$15,000 and will begin the erection of a two-story factory and repair building just east of the building now occupied by them.

Frank H. Hartman, proprietor of the Boyertown Carriage Works, Boyertown, Pa., turned over his business interest to four of his employes. The new corporation is composed of Milton Derr, a carriage builder; John Landis, a blacksmith; Morris Gilbert, painter, and Albert Schuler, trimmer. It is understood that Mr. Hartman will not entirely sever his connection with the company, but will have charge of the wholesaling department of the concern.

The Janesville (Wis.) Carriage Works has passed into the control of the two Buchholz brothers and the estate of the late F. H. Buchholz. This company was organized in 1893. F. H. Buchholz, the manager, died in June of 1909, and his son Carl succeeded him to that position. The new company has increased the capital stock from \$15,000 to \$30,000 and have elected Carl Buchholz president and George O. Buchholz secretary and treasurer. The company, aside from manufacturing the regular line of vehicles, also builds all the bodies for the Monitor Motor Company.

NEW FIRMS AND INCORPORATIONS.

L. Steffen has engaged in the vehicle business in Waco, Neb. McGuire & Small will establish a spoke factory at Aberdeen, Miss.

George Fuller, Cattaraugus, N. Y., has opened a painting and repair shop.

Martin Koksuma has opened a new stock of vehicles, etc., in Downs, Kas.

H. L. Stultz, Hollidaysburg, Pa., has opened a vehicle and implement store.

E. J. Kiesling & Son are putting in a stock of buggies, etc., in Richmond, Mo.

J. W. Lee is reported about to open a stock of vehicles, etc., in Bridgeport, Neb.

J. C. Knupel has engaged in the vehicle and implement business in Hingham, Mont.

The Youngstown (Ohio) Carriage Co., capital stock \$100,000, was incorporated February 20 by W. P. Williamson, C. A. Coch-

ran, John Tod, W. J. Hitchcock and Henry Wick. This is the new Youngstown Carriage Co., successor to the Youngstown Carriage & Wagon Co.

E. A. Durham & Co., are putting in a new stock of vehicles, etc., in Wapanucka, Okla.

Geo. L. Dwinnell will engage in the implement and vehicle business at Waukesha, Wis.

Lanphere Carriage & Auto Co., capital \$15,000, has been incorporated at Carthage, Mo.

Joseph Weeks has engaged in the vehicle and implement business in Newman Grove, Neb.

Buttweiler & Gau have engaged in the retail vehicle and implement business in Freeport, Minn.

The American Wagon Co. has been incorporated in Asheville, N. C., with a capital stock of \$50,000.

S. C. Johnson & Sons have incorporated their vehicle and implement business in Rush City, Minn.

The Capital City Carriage Co. has been incorporated in Des Moines, Ia., with a capital stock of \$25,000.

Cole & Rudesell have established themselves in the vehicle and implement business in Charlotte, Mich.

The Conder Vehicle & Furniture Co. has been incorporated in Kershaw, S. C., with a capital stock of \$10,000.

Fort Worth (Tex.) Wagon Factory, capital \$150,000, incorporated by Paul Waples, B. J. Tillar, Warren Heaton.

The R. Milton Norris Co. has been incorporated in Baltimore, Md., with a capital of \$100,000, to handle carriages, etc.

Henry & Fink and Milton McDonald have formed a partnership and engaged in the vehicle and implement business in Bloomer, Wis.

P. B. & S. H. Matthews are about to erect a wagon factory in Birmingham, Ala. They are connected with the Birmingham Buggy Co.

The W. H. Gillette Mfg. Co. has been incorporated in Louisville, Ky., with a capital of \$100,000, to make buggy and automobile equipments.

J. Thomson & Bros., New Orleans, La., carriages, wagons, carts and vehicles, capital \$5,000, has been incorporated by W. B. Thomson and G. H. Thomson.

Cook Carriage Co., Bloomville, O., carriages, wagons, etc., has been incorporated with a capital of \$25,000 by Thos. L. Gifford, Wren Bolin, H. E. Bair, W. E. Bliss, J. E. Shaw.

Cleveland, O.—Bingham Mfg. Co., to manufacture vehicles, has been incorporated, capital \$25,000. Incorporators, Herbert Bingham, W. C. Rhoades, Wm. H. Gillie, C. B. Dickey, C. F. Schrodz.

With Joseph Stifter, of Fort Smith, Ark., as president, J. C. Wallace, vice-president and James E. Rector, secretary and treasurer, the organization of the American Wagon Company, Asheville, N. C., has been effected. The authorized capital stock of the new concern is \$50,000 and it is largely backed by local capital.

IMPROVEMENTS—EXTENSIONS.

Spaulding Buggy Co. has established a branch at Luling, Tex. Birmingham (Ala.) Buggy Co. will erect a new and enlarged factory.

The Model Carriage Co., Houston, Texas, is about to remodel its factory.

The Bimel Buggy Co., Sidney, O., has increased its capital from \$75,000 to \$85,000.

Morrison Motor Car Co, Chicago, Ill., has increased its capital from \$20,000 to \$50,000.

The Mexico (Mo.) Implement & Harness Co. has moved into a new and larger building.

The Diamond Carriage Co., Spokane, Wash., is building a three-story brick extension.

Ruetter Hub & Spoke Co., Dexter, Mo., has increased its capital from \$24,000 to \$50,000.

Goshen (Ind.) Buggy Top Co. has established an automobile

body upholstering department in connection with its manufacturing plant. R. Austin, of Detroit, Mich., takes charge of the department.

The Colby Motor Co., of Mason City, Ia., has begun the erection of a \$100,000 factory building.

The factory of the Northwest Wheel & Wagon Co., in Beltingham, Wash, is fast nearing completion.

Downing & Averill, of Fullerton, Neb., are about to erect an addition to their vehicle and implement store.

The directors of the Columbia (Pa.) Wagon Co. have called a special meeting for the purpose of voting for or against an increase of the capital stock from \$150,000 to \$250,000.

The Thompson Co., Paxton, Ill., has extended its implement and harness business to Sibley, Ill., and opened a branch. The business at that place will be in charge of Ed. Rudolph.

Plans for an addition to the Porter-Harkness Carriage Company's building, Des Moines, Ia., have been made. The wagon repairing concern is intending to manufacture light truck freight wagons.

Plans are being outlined by the Birmingham (Ala.) Buggy Company for the erection of a modern factory. It is stated the tentative plans call for a three-story factory equipped with modern machinery.

Two big additions to the Pierce Motor Company's plant at Lakeside, Wis., are now under way, which will increase the floor space of the concern 25,000 feet. The additions are 200 feet in length and 62 feet wide.

The W. R. Lantz Carriage Company, Muskogee, Okla., has moved from its old location to a fine new home on South Fourth street. The Lantz company is one of the oldest concerns in the manufacturing business in Muskogee.

It is learned that Lockport men have taken an interest in the Baker Cart Company of Canandaigua, N. Y., and that the concern will be moved to Lockport and opened up on a large scale.

E. R. Thomas Motor Car Co., Buffalo, N. Y., has had its capital increased \$2,100,000.

BIDS.

Georgetown, Miss., has subscribed for a spoke factory.

P. A. Bacon, of the Universal Motor Car Co., Denver, Colo., is touring the East looking for a site. The company is in the field with a truck.

The Hume Carriage Co., of Amesbury, Mass., proposes to move to Boston, where it may have a factory in the Back Bay district containing some 11,500 square feet.

Cincinnati, Ohio, is to have a new industry if the plans of the Universal Motor Company, an embryo concern which will manufacture patented motor trucks, materialize. P. A. Balcom is vice-president.

Indiana capitalists are negotiating for the purchase of the Syracuse (N. Y.) Coal Wagon Company, which was incorporated about a year ago to manufacture coal dumping wagons under the Dalton patent.

A proposition has been made by three Oklahoma and one Arkansas cities to the directors of the Jess & Sturdy Carriage factory, Springfield, Mo., whereby a bonus will be given them if the factory is moved to one or another of the cities.

The Packers Truck Co., of Pittsburg, probably will remove to Wheeling, W. Va., although factory sites in several other places have been tendered. Wheeling capital already is invested in the company, however, and is expected to wield a deciding influence in the matter.

The Florence Wagon Works now at Florence, Ala., have practically decided to make Mobile headquarters. Twenty-five acres of land have been donated for a factory site, also a bonus of \$150,000 in cash. The removal of the works is the outcome of a resolution adopted by the corporation's board of directors about a year ago, when it was decided that, owing to the constantly in-

creasing export business of the company, a change in location was necessary.

Natchez, Miss., stands a chance of getting a spoke factory that will employ fifty men. T. W. Ross, of Georgetown, Mass., and George McMasters, of Moline, Ill., are looking at sites and there is every reason to believe that they will make a selection, as plans and figures were sent to them some time ago.

FIRES.

Hunt & Schwab, Wapello, Iowa, suffered a \$300 fire loss.

The D. Sullivan carriage shop at Norfolk, Va., was damaged by fire.

At Bellefontaine, O., the W. J. Orr spoke factory burned. Loss \$7,000.

James Brown, Athens, Ala., sustained a total loss by fire. Insurance \$1,000.

The stock of vehicles, etc., of J. H. Hale, in Virginia, Neb., has been destroyed by fire.

The stock of vehicles, etc., of Chas Fowler, in Friend, Neb., has been destroyed by fire.

Appleton Mfg. Co., Batavia, Ill., suffered a severe loss by fire in its Omaha, Neb., repository.

W. G. Hadley & Co.'s carriage shop at Bellows Falls, Vt., was destroyed by fire. Loss \$12,000.

F. Keihm and A. Fauser, wagon makers, Brooklyn, N. Y., sustained fire loss. Damage not stated.

The plant of W. G. Hadley Co., Bellows Falls, Vt., was totally destroyed by fire. Loss about \$12,000.

The stock of vehicles and hardware of Lawrence Galliher & Co., in Anita, Ia., has been damaged by fire to the extent of \$50,000.

The branch of Velie Motor Co., Cincinnati, O., had several cars damaged by fire and water. Loss about \$4,000, covered by insurance.

Fire at Council Bluffs, Ia., destroyed the implement building known as warehouse No. 2 of the Warehouse Construction Company. Loss not given. The first and second floors were occupied by the Appleton Mfg. Co., implements and vehicles, of Batavia, Illinois.

BUSINESS TROUBLES.

The Hub Cycle Co., Lima, Ohio, dealers in motors and wheels, has gone into the hands of a receiver, C. J. Brotherton being named. R. E. Thomas, operating head of the company, confessed insolvency.

Petition in bankruptcy has been filed by Frank X. Turcotte, Francis D. Turcotte and Louis D. Turcotte, of Everett, Mass., doing business as Frank X. Turcotte & Sons, carriage repairs and blacksmiths. Liabilities \$701. Assets nominal.

The Detroit Valve & Fittings Co. has brought suit against the Sibley Motor Car Co. to recover possession of the plant of the company located at Detroit. It is claimed that the Sibley company is in default under the terms of a land contract for the purchase of the property.

Harry D. Miller, trustee, has brought action against the Bridgeport (Conn.) Vehicle Co. to foreclose on mortgages. The first paper is dated June 9, 1910, when the Bridgeport Vehicle Co. borrowed \$7,500 from the plaintiff, for which he took the company's note, secured by a mortgage on property.

Mary Healy, doing business in Boston, Mass., as the Healy Wagon Company, is alleged to have made an assignment for the benefit of creditors to Ernest W. Woodside. The petitioning creditors are the R. J. Todd Company, the A. M. Wood Company, and John J. Duff, whose claims amount to \$2,568.

Joseph Ziegler has applied for a receiver for the American Steel Wheel Co., of Alexandria, Ind. The factory was built about three years ago for the purpose of manufacturing steel wheels for which there is said to be a great demand. Owing to the dis-

agreement among the directors, however, the factory was locked up soon after its completion and since that time no work has been accomplished. The incorporators were Joseph Ziegler, Robert Stephenson, Albert Gallam, Joseph C. Brannum, John L. Postal, John R. Welch and John White.

The Dapson & Wolf Carriage Company has gone into involuntary bankruptcy at Oneida, N. Y., with John Wolf and Charles F. Munroe as receivers. The liabilities are between \$25,000 and \$30,000, of which about \$2,000 are preferred, being for wages due the employes, many of whom are stockholders in the company, and some, it is understood, mortgaged their homes to buy stock. The company has been in business for several years and during the past year has had a large trade. It is hoped that the assets will show a favorable condition for continuing the enterprise.

W. L. Morsey has been appointed receiver for the L. B. Tebbets & Sons Carriage Company, St. Louis, against which proceedings in bankruptcy were begun. The firm owned and operated a large carriage and buggy manufacturing plant. L. B. Tebbets is president; George S. Tebbets vice-president; A. M. Tebbets, secretary, and John C. Gee, treasurer. The liabilities are said to be in the neighborhood of \$140,000 and the assets are estimated at a figure somewhat less than that. The failure is said to be due to the heavy slump in the demand for carriages and buggies, caused by the wide use of automobiles.

Because of a judgment for \$8,508.90, which the Commercial Bank and Savings Company secured, the Findlay (Ohio) Carriage Company was thrown into the hands of a receiver, W. D. McCaughey being appointed. The receiver says the company is insolvent to the amount of \$30,000, but that contracts are on hand which will return a profit to the company, which is capitalized at \$150,000. The plant will continue to be operated. The legality of the appointment of W. D. McCaughey as receiver has been attacked by the Driggs-Seabury Ordnance Co., of Sharon, Pa., which filed a suit for \$19,990 damages. Of this \$990 is on account. The petition alleges the local company contracted with the Sharon concern for automobile supplies and the latter was compelled to add new machinery to its plant to turn out the same. It alleges to have made a large amount of accessories and now has no use for them for the reason that they are not standard.

PERSONAL.

V. L. Fowlkes, who traveled for the Cortland Wagon Co., has gone with W. N. Brockway.

E. B. Zimmerman, of the Shamokin (Pa.) Wagon Co., is the probable successful candidate for county treasurer on the Democratic ticket.

W. A. Ebbert, former sales manager for the Moline Wagon Co., has just been re-elected first vice-president and general manager of the Pekin Wagon Co., of Pekin, Ill.

Henry Ratterman (Ratterman & Luth), and O. B. Bannister, (Muncie Wheel & Jobbing Co.) were the star speakers at the latest Cincinnati Carriage Makers' Club dinner.

J. H. Roninger presided at the latest meeting of the St. Louis Implement, Vehicle and Hardware Club at Planters' Hotel. The annual summer outing will take place June 10.

The board of directors of the Bain Wagon Company, Kenosha, Wis., elected Charles C. Brown, president of the First National Bank, secretary and treasurer of the company to succeed the late Frank Slosson.

John L. Cox, secretary and general manager of the Keystone Vehicle Company, Reading, Pa., has tendered his resignation, owing to ill health. Mr. Cox has received several offers from different establishments throughout the state, but will not consider them until he has regained his health. He was receiver of the old Keystone Wagon Works.

Officers of the new Heaton Wagon Factory, Fort Worth, Tex., which is to be in operation by June 1, have been elected as follows: I. H. Burney, president; Van Zandt Jarvis, vice-president;

C. Hightower, secretary and treasurer; Warren Heaton, general manager. Paul Waples, Willard Burton and Ben. J. Tillar have been named as directors.

O. E. Peters, of the Peters Carriage Company, Cincinnati, O., whose friends have been fearful that he would never rise from his bed of sickness, where he has been for the past several months, is recovering nicely.

After identification with the Buck Auto, Implement and Carriage Company, Davenport, Ia., for more than 24 years, John W. Buck, its president, has withdrawn from active interest in the company and the firm has been reorganized. C. F. Buehmann is now president.

NEW INCORPORATIONS IN THE AUTOMOBILE TRADE.

Louisville, Ky.—Urwick Motor Cart Co, capital \$15,000.

Williamsport, Pa.—Keeler Motor Car Co., capital \$50,000.

Raleigh, N. C.—Welfare Automobile Co., capital \$25,000.

Independence, Mo.—J. W. Kerr Auto Co.; capital \$2,000.

Kewanee, Ill.—Matheson Automobile Co., capital \$15,000.

New Orleans, La.—Imperial Motor Car Co., capital \$5,000.

Memphis, Tenn.—Interstate Motor Sale Co., capital \$3,000.

Cincinnati, O.—J. H. Louis Automobile Co., capital \$75,000.

Indianapolis, Ind.—Seaton Spring Wheel Co., capital, \$10,000.

Waukesha, Wis.—Nyberg-Waukesha Automobile Co., capital \$5,000.

Wichita Falls, Tex.—Wichita Falls Motor Car Co.; capital \$160,000.

Wheeling, W. Va.—Auto Car Co., capital \$10,000; by E. R. Romin and others.

Boonville, Ind.—Boonville Auto Co., capital \$10,000; by J. W. Winsett, Andy Franz.

Kansas City, Mo.—Rapid Reliance Motor Truck Co., capital \$20,000; by H. C. Shinip and others.

Des Moines, Ia.—Pitt-Matthews Carriage Co., capital \$10,000; by Mabel A. Pitt, Edwin Matthews, R. G. Griebe.

Detroit, Mich.—King Motor Co., capital \$400,000; to manufacture and deal in automobiles; by H. White, Jr., T. C. Fox and others.

Detroit—Detroit Wheel Co., capital \$1,000,000, by C. R. Chisholm, A. W. Weir and F. A. Switzer; to manufacture a spring wheel. Phipps Grinnell Auto Co., capital \$100,000. King Motor Car Co., capital \$400,000.

St. Louis, Mo.—Steinhauer Truck & Motor Car Co.; capital \$250,000, by Richard Shone, Adolph Kraeter, Peter Steinhauer, and others.

Macon, Ga.—Standard Automobile Co., capital \$20,000; to build automobiles; by J. W. Saunders, Ben C. Smith, R. C. Houser, W. F. Cookerly.

Camp Washington, O.—Victor Lamp Co., capital, \$100,000; to manufacture automobile lamps; by W. J. Corcoran, John L. Corcoran, Edward B. Corcoran, H. R. Kerans, John Galvin.

Lafayette, La.—Lafayette Motor Car Co., limited; capital \$25,000; to manufacture and deal in automobiles; by Charles D. Cafery, S. R. Parkerson, T. M. Blossat, Jr., L. O. Clark, J. E. Trahan.

Indianapolis, Ind.—Motor Car Mfg. Co., capital \$75,000; to manufacture and sell automobiles; by William C. Teasdale, Jr.; Fred C. Dorn, Wayne K. Bromley, Guy O. Simmons, Frank H. Teagle.

EVIDENCES OF GOOD SPRING TRADE.

The Whitney Carriage Co., Leominster, Mass., is working three nights a week.

Peabody Buggy Co., Fostoria, Ohio, had orders on its books for seven months up to February 1 equal to the total business of last year. This will be the capacity limit of the concern without

increasing the size of the plant, which will very probably be done in time to care for the growth of business which is naturally to be expected next year.

The Piedmont Buggy Co., Monroe, N. C., turned out more than 300 buggies in January, and had 450 on the books for February.

The Imperial Wheel Company, Flint, Mich., is enjoying its most successful season, according to Superintendent Arthur V Somers, who says the plant is running to capacity, with more orders ahead than the machines can turn out. The force of employes has increased 100 men during the winter and the pay roll now includes 400 employes.

Penniman & James, of Cambridge, Mass., whose shop site has been a carriage factory for seventy-five years, are having a fine trade. This firm does all kinds of carriage, wagon and automobile work, making a specialty of heavy auto truck bodies and auto wheel work. The present firm has existed about a year. Previous to that it was carried on under the name of Charles Waugh & Co., for about 30 years. From war time up to 1884 the concern was known as Thomas J. Penniman & Co., Mr. Penniman's father being the head of the firm.

The Martin Carriage Co., York, Pa., has started working full time. This is an unusual thing for this time of the year when the business is nominally quiet. It has never occurred before in the history of the firm. The outlook in the general line of horse-drawn vehicles is most encouraging and has been the cause of the increased operation. Since the company's exhibit of the Martin motor truck at the New York show there has also been a noted increase of business in this line and orders for motor vehicles are coming in more rapidly.

COMING EVENTS.

March 11-18, Cleveland, O.—Manufacturers and Dealers' Association's show in Central Armory.

March 14-18, Denver, Col.—Annual show in Denver auditorium.

March 14-18, Syracuse, N. Y.—Syracuse Automobile Dealer's Association's second annual show in State armory.

March 18-25, Pittsburg, Pa.—Annual show in the exposition building.

March 25-April 1, Pittsburg, Pa.—Pittsburg Automobile Dealers' Association's fifth annual show in Duquesne Garden.

March 27-30, Daytona, Fla.—Race meet on Daytona Beach.

April 1-8, Montreal, Can.—Annual show in Coliseum.

HIGH SPEED SEVERE TEST OF MOTOR CARS.

It is not the big jolts that break the car to pieces. Most breakage is the result of vibration, which crystallizes the metal and makes it brittle. Excessive speed produces more vibration than anything else and unless a car is designed with a view to speeding it is rapidly torn to pieces. It is estimated that there is possibly one hundred times the amount of vibration at 90 miles an hour than there is at a speed of 40 miles an hour.

The results of vibration are analogous to those of heat improperly applied. Vibration increases out of all proportion of the increase in speed of the car. From the first shock when the gears are meshed the heat waves begin to rise through the metals in the car. As the vibration increases crystallization occurs. Crystallization is the transformation of molecules in the substance, so that its form which is to all appearance, fibrous, becomes coarse or crystalline structure. Heat treatment of steel is a very accurate process and simply toughens the metal and eliminates the possibility of crystallization to a great degree.

This treatment is accomplished with special furnaces. Very special effort is made to dip the steel at the exactly proper temperature. Different treatment is given to steels for varying purposes. The highest grades of steel are used in motor cars and are inspected with exceeding care before and after it is used.

A GOOD THOUGHT WELL PLANNED.

Preliminary plans have been made by traveling salesmen in Spokane, Wash., and throughout the Inland Empire of the Pacific Northwest to establish a home for indigent commercial travelers in Spokane. Walter P. Edris, postmaster of Spokane, who was a successful salesman before he entered the government service several years ago, is chairman of the committee having the project in hand. The idea has been approved by commercial men in eastern Washington and Oregon, north and central Idaho, western Montana and southeastern British Columbia, and it is expected that work will begin this year.

"We are negotiating for a tract of land on which to build the home," said Mr. Edris in making the first announcement of the project. "The structure will be a credit to this part of the country as well as the men back of the plan, and the grounds will be comfortable as well as ornamental. The building scheme will get its start at the Merchants' and Traveling Men's carnival in the Washington state armory in Spokane, May 1 to 6, after which it is purposed to begin a canvass of the traveling men in America. With the charter membership fees and other means the home can be built.

"There are 600,000 traveling men in this country and all are connected with one or more associations. It will not be a big undertaking to get at least 100,000 to join this proposition when they know that by paying \$1 a year they will always have a home as good as, or better, than they have been used to, where they can go and receive the best of care when adversity comes or life's twilight is swiftly falling. To always have that feeling of security is worth many times \$1 a year. Though they never expect to take advantage of what is offered, there are many men the country over who will join just to know that if things should go wrong there is a safe retreat open to them."

RUBBER AND GUTTA PERCHA IN BORNEO.

A great awakening has taken place during 1910 in regard to the value of the native gums of North Borneo, of which there are four, gutta-percha, gutta jelatong, gutta jangkar, and rubber. About the beginning of 1909 a British company obtained a concession from the Rajah to control the output of the forests of Sarawak, I refer to this enterprise to correct a general impression in regard to the company, viz., though called British, it is said to be backed by American money, and the whole product of the plant goes to the United States.

It is estimated that no less than 40,000 acres have been brought under rubber cultivation in 1910 in British North Borneo. When the trees now being planted become productive it is estimated that 50,000 will be required.—Consul O. H. Baker, Sandakan.

HEAT-RESISTING PAINT.

A recipe for a paint which can be used on steel that is subjected to heat is the following: Boiled linseed oil, 1-5 lb.; japan varnish, 1-5 lb.; turpentine, 2-5 lb.; lamp black, 1½ oz.; pure powdered graphite, 1½ oz.; powdered oxide of manganese, ¾ oz. The japan varnish and linseed oil should be mixed together, then add, in the order named, the lamp black, the graphite and the manganese. The solids must be added slowly while the mixture should be thinned down with turpentine as it thickens. The paint must be applied at once, as it dries quickly, and should be stirred every time before the brush is dipped. The article to be painted is best done if the surface is hot when the paint is applied.

DATE SET FOR WISCONSIN DEALERS.

According to a recent decision of the executive committee, the Wisconsin Retail Implement and Vehicle Dealers' Association will hold its annual convention in Milwaukee on December 12, 13 and 14, 1911.

ROCHESTER DEALERS' MEETING.

Dealers in implements and vehicles gathered for the second annual convention of the New York State Retail Implement and Vehicle Dealers' Association which was held at Rochester, N. Y., February 21 and 22. A general invitation was sent to all the retail dealers in the state urging them to combine with the present members of the association for defense and protection against "the evils which are brought to bear against the retail dealers."

During the afternoon and evening of the second day of the meeting the members attended the meeting and annual banquet of the Empire State Implement Men's Club, at the Powers' Hotel.

The program of the convention included addresses on subjects of interest to retail dealers in implements and vehicles and several discussions on matters which specifically affect the trade, including "Arranging and Marking Goods in Plain Figures" and "How to Increase Membership."

These new officers were elected: President, A. F. Spooner, Richville; vice-president, Bert Giddings, Baldwinsville; secretary and treasurer, C. E. Wethey, Port Byron, re-elected; board of directors, J. L. Marshall, Ithaca; J. K. Henderson, Preble; A. T. Angell, Penn Yan; F. D. Van Wagen, Fulton; Bert Giddings, Baldwinsville; F. H. Ebeling, Syracuse; A. Stewart, Fort Plain, and Frank Howe, Poland.

A membership of two hundred out of the 1,200 hundred dealers in the state was reported. A paid canvasser was suggested to improve the situation.

A NEW TOP COMPANY.

Edward F. Fischer and Adam Metzger have formed a partnership at 112-114 West Court street, Cincinnati, O., under the name of Fischer & Metzger, for the manufacture of buggy and carriage tops, trimmings, cushions, backs, etc. Both are old hands at the business, Mr. Fischer with a record of 14 years and Mr. Metzger having turned out the above products upward of 35 years. They have secured an excellent location and expect to enjoy a large auto top trade from the local houses. This concern is composed of men who are honorable in their dealings with mankind and a bright career is predicted, as they have the right idea of making lasting friends and customers. Our accessory friends will receive a welcome that is well meant and the trade that hooks up with their products will receive honest goods at honest prices.

SOUTHERN DEALERS ELECT OFFICERS.

The Virginia and North Carolina Implement, Machinery and Vehicle Dealers' Association elected the following new officers for 1911: J. W. May, Alexandria Va., president; G. B. Todd, Norfolk, Va., first vice-president; John Slaughter, Goldsboro, N. C., second vice-president; E. C. Tartar, Rural Retreat, Va., third vice-president; Harry P. Stevens, Smithfield, N. C., secretary and treasurer.

Board of Directors—H. L. Smith, Petersburg; W. T. Pace, Franklin; George B. Todd, Norfolk; A. C. Sinton, Richmond; John R. Pender, Tarboro, N. C.; W. B. Wartman, South Hill, Va.; J. D. Barkley, Lawrenceville, Va. The convention adjourned to meet February 7 and 8, 1912, in Greensboro, N. C.

END OF WOODHULL BUSINESS.

The Noyes Manufacturing Company has closed a deal whereby it becomes the owner of the Woodhull buggy plant at Dayton, O. The sale includes the large building and site, for a reported consideration of \$100,000. The Noyes Company is engaged in the manufacture of machinery parts and advertising novelties.

STANDARDS OF GLUE TESTING.

Glue testing is of the greatest importance to the woodworker and the divergence of views, and hitherto proposed tests, lead me to believe that extended discussion of the subject will be of interest to you.

In the first place, when we speak of tests, we at once imply standards. Tests are meaningless unless there be a standard of comparison. To say that "a glue solution has a viscosity of 40" is meaningless until we know not only how strong the solution is, but also whether we are comparing its fluidity with water or with oil. If we say that the glue solution has a viscosity of 40 when under identical conditions, the viscosity of water is 15, we can at once form a mental picture of the "thickness" of the glue solution.

Similarly, the statement that a glue is deficient in strength, at once suggests the question, "With what are you comparing it?" Wood? Stone? Another Glue? If so, what glue? Here is the gist of the problem, writes R. L. Fernbach, in *Wood Craft*. What glues are to be taken as standards of strength and other factors? Is there such a thing as a standard glue? No. Not in the sense that there is a standard steel, or a standard flour or a standard weight. The reason for this is manifest.

Products which result from the activities of an animal organism can not be standardized in the strictest sense. The organism is beyond control. Its product must be accepted as such. While it is possible to control in advance the quality of the steel you are making, by elimination of sulphur and phosphorus, etc., you cannot possibly affect the quality of glue that is to be made from the hide that a steer is wearing, by going to the steer and exploring it to keep its hide in such condition that, after slaughtering and preliminary tanning treatments, said hide will be stock yielding a standard glue?

What is glue? It has been variously defined. It will suffice for our purpose if we describe it as the more or less adhesive, binding and viscous product obtained by subjecting hide trimmings or certain bones to boiling, after such stock has been so treated as to eliminate certain elements and open it up, generally. As to what glue is, chemically, the man has yet to be born who can tell you. We say, learnedly, that it is the hydrolyzed product of the glue-yielding elements within the stock, which is very much like saying that bean soup must be made from beans and not tomatoes!

It is true, nevertheless, that glue does not exist as such within the glue stock. It becomes glue only upon treating the stock with boiling water. The logical inference is, therefore, that there is something in the stock with which the water combines chemically, yielding glue. Such a process is termed, chemically, "hydrolysis"—that is, the permanent combination of more or less water, "hydroxyl," with the elements within the stock. Soap-making is such an hydrolysis. A fat is broken up with boiling lye, water permanently combined in certain proportions and glycerine split off, yielding soap.

There is much to substantiate the theory of hydrolysis as accounting for the chemical origin of glue. Thus, you can get practically no glue out of a particle of hide by simply boiling with water. That is to say, the glue is not in the hide in such form as to simply dissolve in boiling water. If you first treat the hide with weak lime, then neutralize the lime with acid and then boil the hide at suitable temperature, you secure a yield of glue.

Some will tell you that this means that you have so opened the pores of the hide that the glue that is in it now comes readily into solution in the boiling water. If this were so, then the more you opened the hide the more readily would the glue come out. On the contrary if you open the hide too much, by continued liming, you get scarcely any glue at all and that of an inferior quality. Hence the liming or other treatment of the stock simply so prepares it that the glue elements are in best condition to yield true glue.

Another point in favor of the hydrolysis theory is the fact that

glue, up to certain limits, becomes stronger the more water is employed in its solution. Now, this does not mean that you can get stronger glue by dissolving 1 pound to 10 pounds of water, than by dissolving 1 pound to 5 pounds of water! It means this, that if 1 pound of glue is dissolved in a certain amount of water and then jellied, and if the jelly is remelted, adding a little water at the same time; and this jelling, remelting, and water addition is carried out a certain number of times, your glue jelly, at the end, is stronger than was the original jelly.

I can hear someone object: "Of course! Each time you remelt the jelly, you lose a little water by evaporation, so that each succeeding jelly is stronger than the preceding one." I don't mean that. I mean to add about half a pound of water each time you remelt the jelly—which is far more water than it can possibly lose by evaporation in so short a heating.

These facts demonstrate that, in the original glue all of the glue-yielding elements were not completely hydrolyzed; and that subsequent additions of water, melting and jelling, make more and more true glue, until hydrolysis is complete—or the limit mentioned above, has been reached. A practical confirmation of this is the fact that where glue is soaked and melted down in a central kettle, the melt jelled, and portions of the jelly distributed to individual workmen, less actual dry glue is used in a given time for given work, than if the glue has been prepared by each workman in a separate small glue-pot.

All this tends to show that glue is the result of a chemical process. Why then, can it not be controlled in the same way that the quality of steel is controlled? Bear in mind that hydrolysis can be effected only in one way; to-wit, by boiling with water, or with a caustic alkali in water. The fundamental stock for glue is organic, not mineral. If you were to treat it with boiling alkali, you get a useless mess; not glue. Unlike iron ore, you can not subject glue-stock to a fiery heat to eliminate undesirable elements, without eliminating the stock in toto. While iron ores differ in constitution, uniform steel can be made from all, because a multitude of chemical processes can be applied. On the other hand, all that can be done to glue-stock, is to treat it with lime, and then boil it. Any other treatment will virtually destroy the stock.

For similar reasons, no standard leather exists. A standard leather could only be formulated by a coalition of tanners. They might say that a standard sole leather, for example, is leather made from a certain quality of hides, limed for such and such a length of time, and tanned with liquors of a certain strength, and stuffed in a certain way.

You will note that the standardization, in this case, is one of raw material and processes. It is not standardization as in steel, which implied the content of just so much iron, carbon, silicon, phosphorus and sulphur. The minute the quality of the initial hides changes—a factor beyond human control—tanning processes must be altered in order to produce goods of the same quality as the initial standard. This means that the new goods will have a totally different composition from the original standard. If a standard can not be constantly duplicated, the attempt to standardize fails.

What is true of the leather industry is just as true of the glue industry. There can be no standard glue, in the strictest sense, because the materials from which we make glue are subject to sudden change. Hence, furthermore, any standardization for comparison, must be on the basis of physical properties and not chemical ones. You can see that even if the raw material does change, processes can also be changed so as to produce from the raw material a product of corresponding physical properties, but not chemical.

PASS DIVIDEND.

The directors of the Kentucky Wagon Manufacturing Company, Louisville, Ky., passed their quarterly dividend of one and one-half per cent.

PROMINENT MAN HAS HIMSELF INTERVIEWED ON SELDEN PATENT.

A gentleman who is spoken of only as "None stands higher in the trade," thus has himself quoted about matters of interest:

"Whatever people may say of the Selden patent, and regardless of the merits of the patent itself, the data which it rendered available was of almost priceless value to the industry, and the benefits of co-operation of business rivals was never better demonstrated than by some of the accomplishments of the Association of Licensed Automobile Manufacturers.

"The need for an organization of the sort has been well indicated by straws which have been stirred by the wind since the Selden patent was declared invalid.

"The immediate result of the upset of the Selden patent has been to bring to the surface a number of other alleged basic patents whose owners or exploiters imagine they see millions in them. They are offering them for sale or attempting to form combinations around them and this sort of thing requires that form of insurance which is born of a well-knit organization.

"To the manufacturer who produces two or three or four hundred cars per year, a royalty of one or two or three dollars per car represents but a comparatively small item and because of the fact some of the smaller manufacturers are prone to take the easiest way out and to accede to such demands rather than to engage in expensive litigation. To the manufacturer who has an output of thousands instead of hundreds of cars, however, the royalty demanded by two or three such sources represents a pretty sum, and unless there is a united front presented each manufacturer must necessarily fight his own battles against each individual exploiter.

"It is not wholly a secret that there are several members of the Association of Licensed Automobile Manufacturers who own patents that they believe to be quite generally infringed, and that they have been itching to take action even within the association itself. This spirit was manifested on various occasions during recent years, and it was only that arbitration which comes of a community of interest that prevented the institution of legal proceedings against the infringers.

"One of the underlying ideas of the proposed new corporation is that when the individual manufacturer is threatened by such litigation there shall be an organization ready and willing and competent to take care of it for him, and at the cost of the corporation itself. In other words, the new organization, like the old one, will serve as a common defender on the 'one-for-all,' 'all-for-one' principle.

"The provision in the prospectus of the proposed corporation that its stockholders shall render quarterly reports of their production and pay into the treasury 1-10 of 1 per cent. of its value is wiser and more beneficial than may appear on the surface. It permits an absolute check to be kept on the industry and the information is equally valuable to all. The value that such records held for the members of the A. L. A. M. is not easily estimated.

"Let us assume, for instance, that a man has in mind the production of, say six-cylinder cars or two-cycle cars, or trucks of whatever sort. Where else can he obtain authentic information than from such records? They have kept many a man on safe ground, and whenever they are available they always will do so.

"The idea that because so many of the larger manufacturers are prominent in the A. L. A. M. and are interested in the formation of the corporation which will succeed it, are seeking to dominate the trade is another notion that deserves to be thoroughly exploded. They are seeking to do nothing of the sort. In fact, there are fifteen or twenty of us that could form an organization of our own and perhaps better serve our purposes, but we have the whole good of the industry at heart and are, therefore, ready and willing to co-operate with the smaller makers. In becoming members of such organizations we have no more voting power than those who produce one-tenth as many cars, and as the small

manufacturers always outnumber the larger ones it means that the latter almost place themselves at the mercy of the former. We can be outvoted on almost any question. This is one standpoint from which the situation rarely is viewed, but that it represents a fact is self-evident."

WORM DRIVE NOT NEW.

Our accomplished "pioneers" of the worm drive for motorcars have been anticipated by Germany and about four and a half centuries. The system was applied in the far-off days when the Emperor Maximilian reigned. The designer seems to have had a fairly deep insight into the technicalities of mechanical traction, besides pronounced artistic leanings. He provided against possible adhesion troubles by applying his power to all four wheels. How the mere steering of the car was effected, however, remains somewhat obscure.

Apparently the "worm on top" arrangement was then favored. And, doubtless, the reason was one urged for it to-day, viz., that the transmission is thus brought into line with the "motors."

The modern fad of mounting mascot and badge upon one's car was, also, a weakness of Maximilian.—D. W. G. in *The Motor*.

PAPER TIRE SHOES.

Finding that car wheels made from papier-mache possess great strength and a remarkable ability to withstand sudden shocks, French engineers have just placed on the market an automobile tire shoe made exclusively from paper. It consists of a number of thin, unglazed sheets of paper, cut into proper shape and laid one upon the other, which are impregnated with certain resinous substances and then subjected to enormous pressure. The resulting tire shoe, modeled over a form and snugly fitting over inner tubes of the corresponding size, is said to be absolutely impervious to water, weak acids and alkalies, and to possess a high degree of resiliency and strength. As the various layers of paper are not saturated with a hardening glue, which would cause the resulting material to become stiff and unyielding, but are impregnated with a resin which remains pliable, it yields to the inequalities of the road surface quite as readily as the outer shoe of a rubber tire. The papier-mache tires are said to be as durable as those of fabric and rubber, while their cost is but a fraction of the same.

HAYNES PLANT WRECKED BY FIRE.

Fire practically destroyed the big plant of the Haynes Automobile Co., in Kokomo, Ind., causing a loss of approximately \$750,000. Two wings of the factory were utterly wrecked and the third was badly damaged, a high wind which prevailed rendering the efforts of the firemen almost unavailing. A number of completed cars were saved. The fire started in the assembly room, where a workman was washing a car with gasoline, which was ignited by a spark from a wire on an electric light which was being used and which short-circuited on the frame of the car. The flames spread with great rapidity and a number of employes had narrow escapes. The insurance carried approximates \$250,000.

LICENSED DEALERS' DISBAND.

Many dealers organizations that propped up against the Selden patent have concluded best to dissolve and let bygones be bygones. All that was in the orange has been squeezed out of it.

KINSEY-IDEAL.

The Kinsey Motor Car Co. has taken over the Ideal Motor Car Co., both of Detroit. Stockholders in both being nearly identical, it amounts to a change in name merely.

Late Automobile Trimming Fashions.

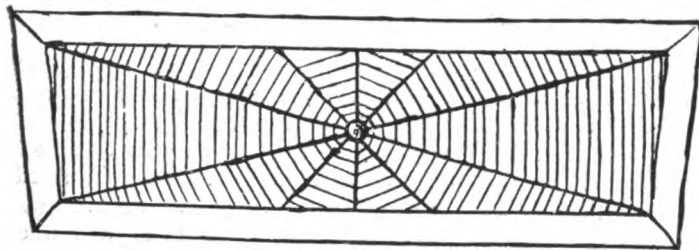

Fig. 1.—The spider's web lining board treated in the same manner as the door, Fig. 7.

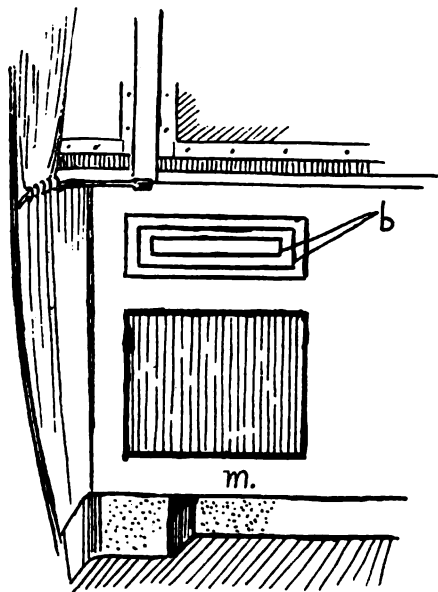

Fig. 2.—The lining board and inside of the D-front of a closed body by a continental firm; b, brass strip; m, mahogany. The large square is of plain cloth.

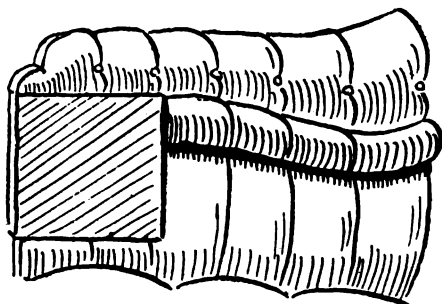

Fig. 3.—The drop elbow provided with a well sloped cushion. The square is a polished cabinet let in flush with the trimming.

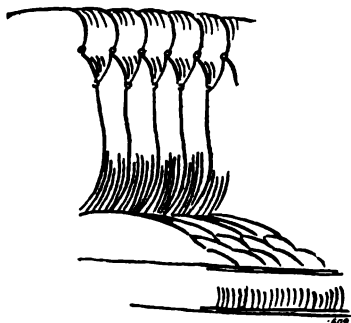

Fig. 4.—Cushion and back squab marked out to match one another.

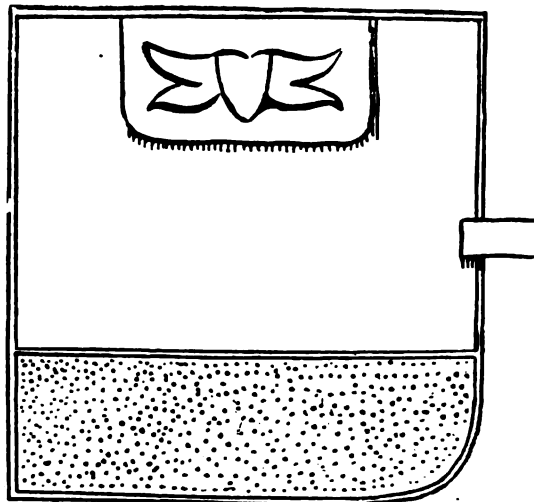

Fig. 5—Door of a side-entrance phaeton, with carpet at bottom and leather main portion, with embossed panel in same material.

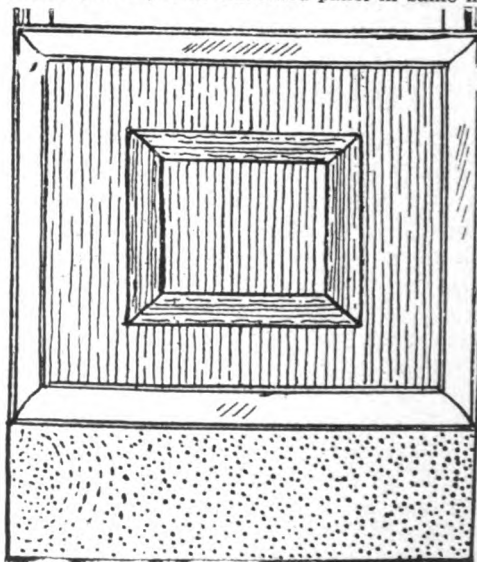

Fig. 6—Door with carpet on bottom, mahogany outer frame, plain cloth and inner frame of broad lace.

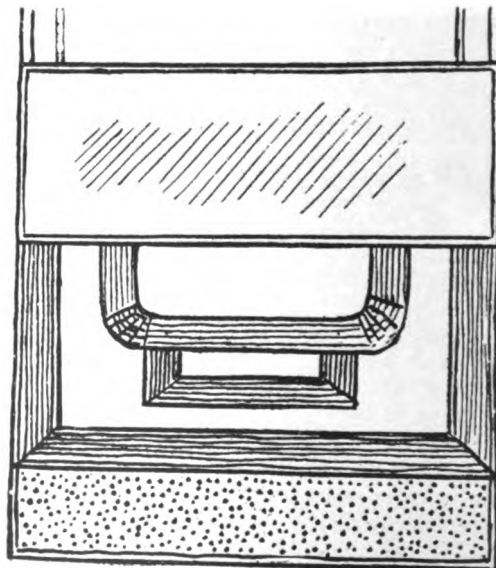

Fig. 10—Polished wood top, carpet bottom, cloth pocket and broad lace.

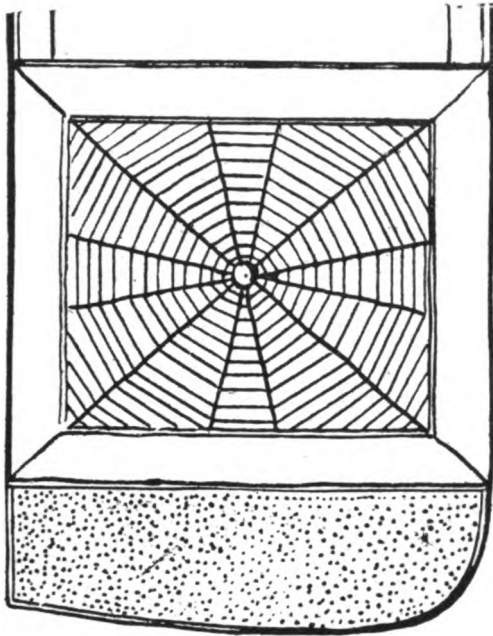

Fig. 7—A spider's web device made by cutting out each section according to the way of the cloth, sewing them together and hiding the seam with a piece of cord. The border is broad lace, and there is the usual carpet at the bottom.

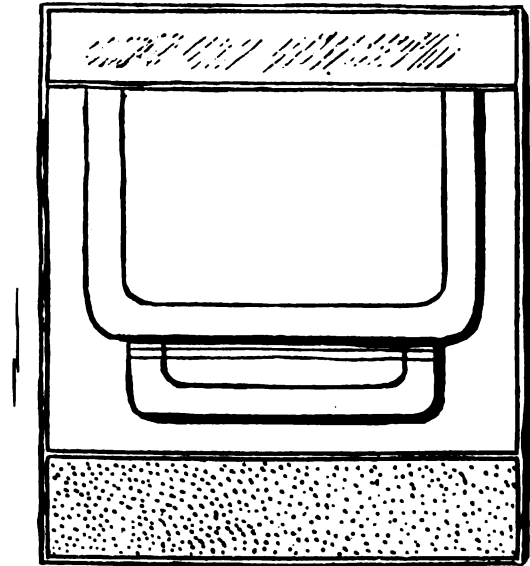

Fig. 11—The door of a closed body. The top piece is polished, the bottom one carpet, and the rest a cloth pocket bound with broad lace.

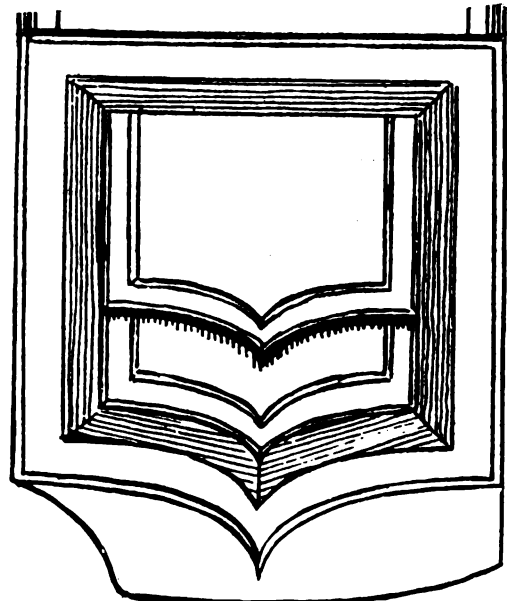

Fig. 9—The outer border is cloth, then comes broad lace, and a pocket bound with narrow lace.

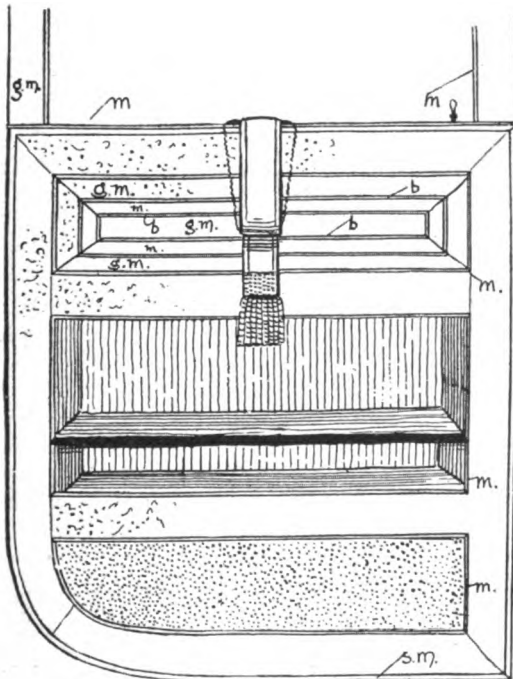

Fig. 8—g.m., grey stained bird's-eye maple; m, mahogany beading; b, brass strip; s.m., narrow lace. In the centre is a cloth pocket bound with broad lace, and the usual carpet is found at the bottom.

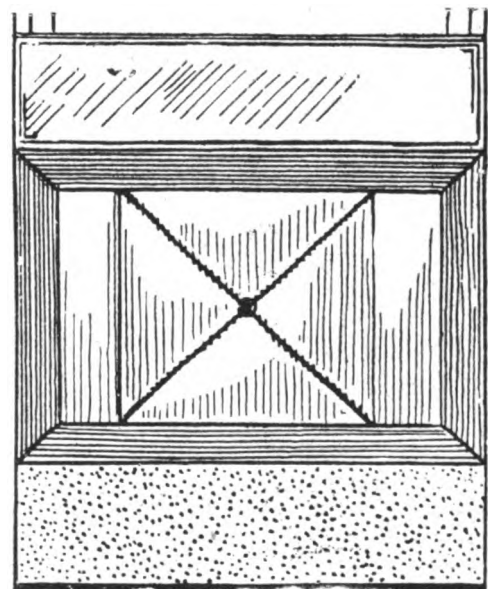

Fig. 12—Similar to No. 10, but no pocket.

SOMETHING ABOUT THE MAN AND THE OPPORTUNITY.

Alfred Reeves, general manager of the Association of Licensed Automobile Manufacturers, in his address before the automobile school of the Y. M. C. A. in Brooklyn said:

The automobile trade has been a young man's business since its inception and the greatest successes have been scored by young men. Among the eighty factories in the A. L. A. M. the youngest president, and he heads a successful million dollar company, is only 31 years old, while the average of the president of those companies is not more than 42, with a few older and very substantial business men who have made great leaders. This record is unequalled.

As indicating the names of those men whose names are now household words. The names of such pioneers is Winton, Ford, Haynes, Packard, Maxwell, Buick, Olds, Duryea, and others of that type. All those I have mentioned, and many others, worked as mechanics at the bench, while most of them are now presidents of their respective companies. They have been assisted in attaining their positions by business men of ability who have helped to make the motor car business the standard business that it is. Such captains of industry as Charles Clifton, Benjamin Briscoe, S. T. Davis, Jr., James Couzens, Ransom E. Olds, W. C. Durant, Hugh Chalmers, Thomas Henderson, John N. Wyllys, H. B. Joy, R. M. Owen, Roy D. Chapin, Walter E. Flanders, Albert L. Pope, W. E. Metzger, H. H. Franklin, H. O. Smith, and a dozen others, will have their names identified with the upbuilding of the motor car trade.

The motor car trade is now at its best for it has passed the stage of wild-catting. Very few new concerns will be launched in the future, for that field is well filled, as the factories now in existence are able to manufacture 300,000 cars annually, if required. It is estimated, however, that the product of 1911, including commercial vehicles, will be about 210,000 cars, as against 190,000 in 1910.

While the present machines with their silent, powerful motors and excellent design and construction would seem to be almost perfect, they are bound to undergo radical changes. Greater simplicity and easier control, self-starters for motors, improvements in transmission of power, greater economy in fuel consumption, and improved or cheaper tires, offer an endless field.

Men will be welcomed who bring new ideas.

The man who succeeds must be above the average. He must not be an ordinary salesman, but a star salesman; not a plain driver, but an expert driver; not an inventor of small things, but a producer of big things.

The record growth of the automobile business during the past ten years has been startling to the conservative business man who could not bring himself to believe that motoring was more than a pastime and that the motor car is just as much a necessity as the telephone, the telegraph or transportation lines. For a number of years these conservatives have predicted failure, yet each year has seen more and better motor cars produced and more and more men employed until now we have such startling figures as the following:

Three hundred automobile factories in America, of which 125 are beyond the experimental stage and are producing 50 or more machines a year.

\$475,000,000 capital in the motor car and accessory business, of which \$285,000,000 is in motor car factories alone.

410,000 automobiles manufactured during the past ten years, almost all of which are in use.

278,000 men employed in the various branches of motor car making and selling.

9,400 dealers in America, most of whom maintain salesrooms or garages.

Motor cars are now used the world over, even in the most remote parts of Asia and Africa. So far as I know, there is only one place where motor cars are not used, and that is in Bermuda, where the roads are so narrow as to make motoring unsafe. The authorities have therefore prohibited their use on the islands.

The normal demand for cars in future is expected to be about 175,000 pleasure cars annually, many of which will go to the farmers. As to the number of freight-carrying machines that can be used, only time will tell. It is a fact, however, that with 7,000,000 horse-drawn vehicles in the country, a very large number must be replaced with motor cars and that field offers the greatest future. Motor-driven vehicles will solve those many problems involved in our present wasteful method of transferring merchandise by horse-drawn vehicles. Using a motor car which will carry twice the load at twice the speed and requiring only half the space, will be like increasing the width of streets six times.

As a willing slave for all sorts of work, the motor vehicle is entering that broad commercial field which will bring quicker and more economical distribution of merchandise. It foretells the well-earned emancipation of the horse and brings close to hand the time when the noble animal will become the pet of mankind instead of the slave of the business world. Horses will not be relegated quickly; yet the displacement proposition must go on at a steady pace. I have frequently expressed the opinion that ten years from now, a horse on the streets of New York will be as rare as was the motor vehicle ten years ago.

The automobile trade is no easier than any other, and in fact is a much faster moving business than any other. There is money and fame for the man who will work loyally. One must use his head as well as his hands, however. Generally speaking, men are much alike except as to their heads. Every man has two arms, two legs, and the other characteristics. The difference lies in the amount of brains. Money earns interest, but it requires brains to earn fame and dividends.

COMMERCIAL MOTORS FOR ENGLAND.

In the manufacture of commercial motor vehicles for the present market in the United Kingdom, says Consul General J. L. Griffith, a machine to command a ready market must combine lightness, smoothness, and noiselessness in running with reliability and durability. Commercial motor vehicles did not become practically possible in Great Britain until the passing of 1896 of the light locomotives act. Little advance, however, was made for some considerable time, owing to the fact that the first models were not practicable. One or two months' service generally rendered them useless. So great is the popularity of the mechanically propelled commercial vehicle now that in September, 1909, there were 15,191 trade vehicles registered under the act. Of this number, some 6,500 were wagons of 3 tons (6,720 pounds) burden and over, and 8,700 were light delivery vans. The latter were motor driven, and of the former by far the greater number were motor propelled, many being driven by petrol (gasoline) engines; but usually the greater weight reduces the speed.

In some instances fire boilers have been used, particularly for the heavier class, and it is claimed by some that such fire boiler engines are cheaper than those driven by petrol. Light delivery vans are almost universally driven by petrol engines to avoid the danger from sparks issuing from fire-engine boilers.

RUBBER INVESTMENTS IN NETHERLANDS INDIA.

Capital to the amount of \$78,935,000 was invested in rubber cultivation in the Netherlands India up to the end of June of 1910. The investments up to 1909 had been \$14,608,400, while the rubber investments in 1909 were \$15,926,000.—From Consul B. S. Rairden, Batavia, Java.

AGAIN THE GAS-ELECTRIC MOTOR.

We think *The Hub* was the first to draw attention to this character of vehicle propulsive power, but since the crude early attempts much progress has been made.

The gasoline engine presents almost the same efficiency in the smaller units that it does in the larger ones, so it is possible to use them direct connected to generators for furnishing electric power on a most economical basis. It furnishes cheaper power than the steam plant.

The smoothness with which the power is transmitted, and the per cent of loss being constant with large or small load, has made it adaptable to vehicles. It will be a strong competitor of the storage battery, and is well worth the attention of the wagon builder.

In early examples to supply enough power and reduce weight the generator had to be pushed to a high speed that the engines would not stand. Drivers in most cases had little mechanical ability and were unable to handle the engines properly, and to keep them in repair, and while the results were in some cases more satisfactory than the ordinary shaft drive, it was found necessary to design a new engine more powerful for the weight, and less intricate than the old, and to build a new generator combining the desirable qualities of light weight and low speed that would enable the engine to perform the desired work without being run at an excessive speed for the purpose.

The engine now in successful use is the two-cycle, and each piston delivers a power stroke for every revolution of the crank shaft. The engine is constructed on the unit principle, whereby one, two, three, or four cylinders may be assembled together as required, and it may be assembled to operate either in a vertical or horizontal position. Special features of this new engine are the built up crank shaft and the rotary plate valve. The valve is a cast iron disc, placed concentric with and driven by the crank shaft, and held against the inside of the crank case by light pressure springs back of the driving lugs. This plate has a port which registers at definite intervals with the inlet port to the crankcase and also with the port from the crank case to the transfer pipe and cylinders. The inlet port controlled by this valve is open during a full half revolution of the crank shaft, which vastly simplifies the carburetor problem as compared with the ordinary two-cycle engine, the charge being drawn in during the full suction stroke as in the four-stroke cycle. When the inlet port is covered by the valve (the piston being at the top of its stroke) the crank case is completely closed, as is also the transfer port.

To this engine is directly connected the special generator, which is of necessity self exciting under all conditions, and also self regulating so that an increase of speed will not raise the voltage high enough to burn out the wiring. A special pole-piece construction allows the generator to be operated with a voltage sufficiently low to give such output that the engine will not be stalled, even though the load be applied instantly. Also, when the engine is throttled down to the lowest point, the generator being short-circuited, as is the case when two motors are connected in multiple on the circuit, there is sufficient starting current of a voltage high enough to move their armatures.

The traction drive is obtained by motors connected to the rear wheels through chains and sprockets, and completely encased to prevent the introduction of mud and water. The entire outfit is controlled by the operator through the throttle of the engine, the operation of motors and generator being entirely automatic.

Several of this new type of motor truck are already in operation and giving excellent service, while many other old battery trucks have been converted to gas-electric drives with entire success. It is very possible that the near future will see more of these vehicles in operation, as they combine all the advantages of the electric drive with the economy in operation of the gasoline vehicle.

ANOTHER NEW POWER.

Compressed nitrogen makes its debut as something the auto-car user will need. It is a patented commodity. With regard to its application to the motorcar, the inventions provide that compressed nitrogen is to be used for driving machinery by expansion in all those cases where, up to now, combustible fluids have been used. It will also take the place of electric accumulators, compressed air, etc., where these have been used for driving power. The exploiters of the system further state that "the economic advantages of nitrogen for driving power are found, above all, in the reduced weight and simple construction of a nitrogen motor, it is lighter than any other power generator, and its cost of installation is, therefore, considerably less. The life of such a machine is, in consequence of its construction and the very limited number of its moving parts, a great deal longer in comparison with the gasoline or other motor. Nitrogen is a gas conducting itself differently at ordinary temperatures, therefore, it will never corrode metals nor oxidize the greases used in lubrication."

With regard to the cost of running, it is claimed that it is less even than gasoline, but supposing the cost of working would not be less than with the gasoline motor, the advantages offered by the nitrogen motor, with regard to cheaper initial cost of motor, its longer life, its low cost of maintenance, and the small amount of lubricants necessary are, the promoters state, important factors. The use of a nitrogen motor is perfectly clean and said to be free from danger. It requires neither ignition no cooling, and it is ready to start at any time.

BUGGY SEAT DESIGN.

Many of the so-called automobile seats that are now popular in the new vehicle drafts shown by builders could have a touch

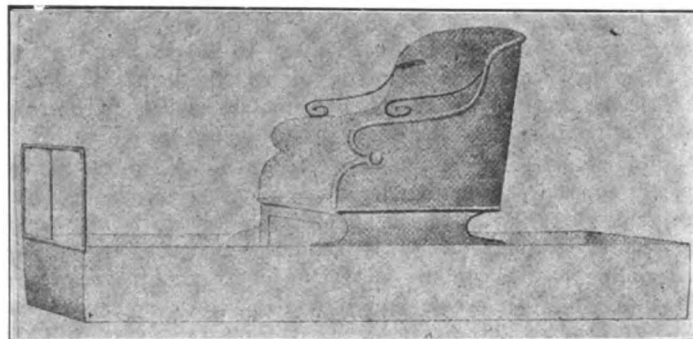

here and there of grace and novelty that might add to the attractiveness.

We show such a modification of curves in an illustration herewith that may be suggestive or appeal to those who do not want to copy closely such as are already shown.

NEW THOMAS COMPANY CHOOSES OFFICERS.

The organization of the new E. R. Thomas Motor Car Co., which, financed by the New York banking house, Eugene Meyer, Jr. & Co., has taken over the business of the E. R. Thomas Motor Co., of Buffalo, has been completed by the election of officers, all of whom are former Packard men. E. P. Chalfant has assumed the presidency, the other officials selected being F. R. Humpage, vice-president and general manager; J. J. Ramsey, treasurer. W. L. Gleason, the former factory manager of the Packard company, will occupy a similar position in the new Thomas establishment. Eugene Meyer, who financed the new undertaking, is the banker to whom Benjamin Briscoe, president of the United States Motors Co., introduced the creditors' committee, when the latter first sought to disentangle the Thomas Motor Company's affairs.

WAY THINGS LOOK IN PARIS.

In considering the complete design, there are some things which should be borne in mind; first, utility; secondly, appearance, having regard to the purpose of the design. The motor carriage is being divided into two great types; those driven by the owner and those which are driven by a servant. These again are divided into classes; the small two-seater, open and closed, with servant's seat behind; the larger two-seater, entirely enclosed; the four- and six-seaters of the torpedo or flush-side pattern, with the entirely opening Cape hood; and the entirely enclosed saloon pattern. The cabriolet is not favored in French design. The second great type is exemplified in the landaulet and limousine.

The same chassis and engine horsepower is not suitable for all of these various classes. The styles of chassis are roughly divided into two; the one with the radiator in front, either square or wedge-shaped, and the other with the radiator at the rear of the engines. Each of these patterns has its friends, who advocate its adoption for various reasons, but for all the larger cars, the pattern in which the radiator is placed at the rear severely handicaps the designer of the complete vehicle. However elegant may be the lines and the treatment, as in the latest Renault design, the bulk cannot be suppressed, and the whole design has to be merged in those fixed lines which occupy a prominent position well towards the center of the carriage.

A number of French firms have made the front of a more rigid pattern than before by affixing the gasoline tank immediately behind the engine. This may be an advantage, for it places the feed above the carburetor whether ascending or descending a hill, and avoids long connections. It also keeps the rear end of the car clear, but to obtain an aesthetic effect some modification of design will have to be adopted.

In many instances the frame of the chassis has been dropped and the rear end raised accordingly to clear the axle. To bring the chassis frame nearer the ground, wheels of 30 inches diameter have been used, irrespective of the length of the frame or the horsepower. It is apparently too much to expect that the size of the wheels should have some relation to the length or size of the chassis, or to the horsepower of the engine. From the aesthetic point of view there is a proportionate size.

So far as the chassis frame was concerned, our French friends did not appear to have introduced any novelty, except the gasoline tank on the dash, which affected the carriage work. In all the points which make towards facilitating access to the seating and adding to the comfort and convenience of the driver and passengers they are where they were two years ago. Suspension has settled down to the grasshopper or long spring type, and the bow-ended top half for variation. There were a few cross rear-springs, but not very many. One or two cars were fitted with modified grasshopper springs to which C ends had been fitted with short elbow springs to connect up to the chassis, a modification of the Charron practise some seasons ago.

The convenience of the owner-driver did not appear to have been studied to any considerable extent by the motor manufacturer or coachbuilder exhibiting at the Salon. There were very few instances seen where the driver had access on the off side. There were no doors, and the levers were outside. Only one instance of a practicable door was noticed, and there a spare tire blocked the way. High doors to the front seats of landaulets and limousines were the exception. The cabriolet front seat, almost universal in Britain, was seen on two or three of the fronts of large cars fitted with high doors. The limousines and landaulettes and many of the flush-sided cars were only made to carry two persons on the rear seat.

Only one example of the rounded-out rear seat of a phaeton, to carry three persons, was noticed, which shows how completely this pattern has gone out of fashion.

The Alma (Mich.) Mfg. Co., which made engines solely, has branched out into the business of cars.

IN THE SPOTLIGHT

Traveling disinfecting "chambers" recently have been introduced in Paris by the French Public Health Department, and are used by the sanitary authorities in dealing with infectious diseases. Each "chamber" consists of a standard automobile chassis.

Although a knack is required to crank a motor, the cranking often can be rendered easier by the substitution of a lighter releasing spring. When the spring is too strong the slightest relaxing of pressure on the part of the person cranking the engine causes the handle to fly out and disengage itself, necessitating its being turned around and pressed in place again. As a rule a much lighter spring than is commonly used will serve to keep the ratchet out of engagement while the motor is running, while a liberal use of oil will also facilitate cranking.

One of the many prolific residents of France has devised a nail that, once it has been driven into place, resists all efforts to pull it out. The point of the nail is slit through its center nearly two-thirds the distance to the head, like a cotter pin, and as the nail is driven, the two parts curl into the wood.

LIGHTNING CHANGE.

Between two days the DeTamble Motors Co., of Anderson, Ind., was in the hands of a receiver and out again, the judge obliging by holding night court to straighten things out. The concern is now reorganized and officered as follows: President, J. J. Appel; vice-president, E. W. Orbogast; secretary, C. Forth.

MOTORETTES WANTED.

E. H. Bryan, Dillon, Ga., wants motorettes, and would like to hear from makers of this class of vehicle.

Wants

Help and situation wanted advertisements, one cent a word; all other advertisements in this department, 5 cents a word. Initials and figures count as words. Minimum price, 30 cents for each advertisement.

POSITION WANTED.

Position Wanted—A thoroughly competent man with experience in designing, drafting and building of carriage and automobile bodies, desires position as draftsman or foreman of body department. Address W. K., 24, care The Hub, 24 Murray St., New York.

HELP WANTED.

Wanted—A well connected English firm in the wheel trade wishes to communicate with a spoke producing firm in U. S. A. with a view to placing large and constant orders for hickory spokes, and is prepared now to place an order for 100,000 finished spokes (hickory) ungraded of various sizes, viz., 1¼, 1½, 1¾, 2, 2¼, 27 in. long, Sarven pattern. Reply stating lowest price and time to The Trade News Pub. Co., 24 Murray St., New York.

Wanted—A large carriage factory located in the Middle West wishes to secure the services of a first class superintendent. A young man preferred. In answering give full particulars as to experience, references, and present salary. Address J. C. T., care the Hub, 24 Murray St., New York.

Wanted—Superintendent for factory employing from 150 to 175 men on high grade limousines, coaches, hearses, etc. Address The Hub, E. S., 94, 24 Murray Murray St., New York.

FOR SALE.

For Sale—Carriage factory machinery. If interested write for list. J. N. Grady, Owensboro, K. Y.

PATENTS.

Patents—H. W. T. Jenner, patent attorney and mechanical expert, 608 F St., Washington, D. C. Established 1883. I make a free examination and report if a patent can be had and exactly what it will cost. Send for circular.

The TIMKEN ROLLER BEARING CO.

MAKERS OF TIMKEN ROLLER BEARING AXLES
for **WAGONS** and **CARRIAGES**



Canton, Ohio

A Set of
TIMKEN AXLES
will save your
CUSTOMERS
these two horses

This statement is based on the experience of thousands of users.

New Catalog and Price List upon application.

THE TIMKEN ROLLER BEARING CO.,
CANTON, OHIO,

BRANCHES- 10 E. 31 st Street, New York.
429 Wabash Avenue, Chicago.

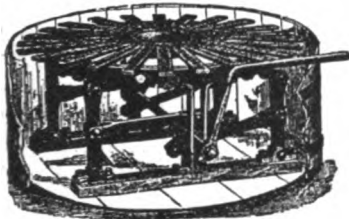

The Bokop Tire Setter and Cooler
Is the Best and Only Machine that has stood the test during the last 12 years on all classes of work, and is the Only Machine built with the Indestructible Wrought Iron Face Plate.
Over 1,000 are in successful operation, repairs on which have not exceeded \$6.00 in the last 12 years. For prices, references and descriptive circulars, address
BOKOP, WEBB & PALM,
Defiance, Ohio

E. SCOTT PAYNE CO.
OF BALTIMORE CITY
**CARRIAGE AND AUTOMOBILE
HARDWARE**
362 and 364 North Gay Street,
BALTIMORE, MD.

CARRIAGE SPRINGS OF EVERY STYLE AND PAT- TERN TO ORDER

Also Curtain Rollers and Concealed Hinges

EXCLUSIVELY FIRST-CLASS WORK

THE BEST THAT CAN BE MADE

SPRING PERCH CO.

BRIDGEPORT, CONN.

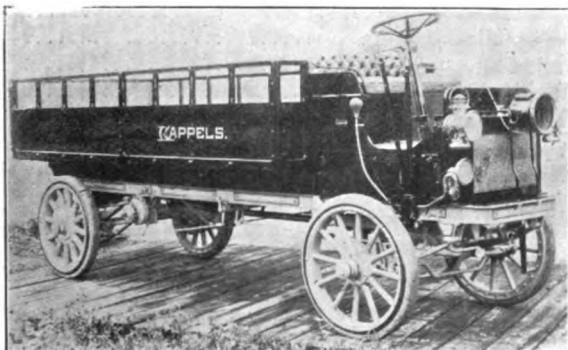

The Grammm is made in 1-ton, 2-ton, 3-ton and 5-ton models.

The GRAMM Was a Success Before Other Commercial Cars Came Into Existence

Ask any well posted man to tell you what commercial cars were prominent when the really great American pleasure cars were first making history.

"Well," he will say, "there was the Grammm —"

And there he will stop. He knows the Grammm because a decade ago B. A. Grammm had marked out the way for other successful trucks to follow. The Grammm was a notable, practical achievement long before competing commercial cars came into being.

Those years of extraordinary experience are the Grammm's greatest asset; no truck buyer can close his

eyes to the fact that other trucks must pass slowly through the same trying period of development.

Wherever the Grammm has entered into a contest with other trucks, the value of that long experience in truck building was made clear.

The Grammm has not only made repeated perfect road and technical scores when handicapped with overloads, but **IT WAS ALWAYS READY TO REPEAT ITS SUPERB PERFORMANCE.**

In addition to the Grammm's efficiency, its marvelous records in economy tests offer the most powerful appeal possible to the shrewd truck buyer.

You must inevitably judge all other motor trucks by the Grammm.

THE GRAMM MOTOR CAR CO.,

107 South Lima Street, **Lima, Ohio, U. S. A.**

New York Headquarters: **CROSS-MAGILL MOTOR TRUCK CO.,** 30 Church St., New York City.

Let us send you our monthly "Grammm."

The Higgin
LINE OF CARRIAGE TRIMMINGS

KNOBS



No. 70.



No. 133

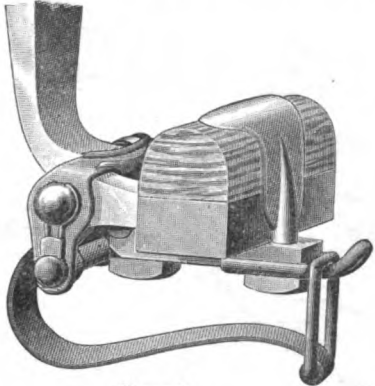

Closed.
The Higgin Quick Shifter.

KNOBS



No. 72.



No. 130.



Full Leather



No. 74.



No. 13—Black Japan Nut

QUALITY UNSURPASSED.
Send for catalogue and get acquainted with our line.
The Higgin Mfg. Co. Newport, Ky.



A. OCHSNER & SONS CO.
NEW HAVEN, CONN.

Auto and Carriage
Locks, Hinges, Etc.

VEHICLE AND AUTO TOP HARDWARE
Rails, Joints, Bow Sockets for the
WHOLESALE TRADE ONLY
Write
INDIANA FORGING COMPANY.
Mention Hub. INDIANAPOLIS, IND.

Headquarters for "The H. D. Smith & Co.'s" Carriage and Wagon Forgings

JACOB GERHAB

Dealer in

Carriage Cloths, Leathers and Trimmings, Wagon and Cart Material

Salable prices and all information cheerfully furnished.

158, 160, 162 and 164 North Third Street.
PHILADELPHIA, PA.

INDEX TO ADVERTISEMENTS.

| | |
|------------------------------------------------|-----------|
| American Ball Bearing Co., The | 3 |
| American Roller Bearing Fifth Wheel Co. | 18 |
| Ault & Wiborg Co., The | 3 |
| Bailey & Co., Inc., S. R. | 18 |
| Barbour Steel Tire Co. | 4th cover |
| Bokop, Webb & Palm | 11 |
| Boub Wheel Co., H., The | 18 |
| Columbus Bolt Works | 4th cover |
| Consolidated Rubber Tire Co. | 2nd cover |
| Crane & MacMahon | 2nd cover |
| Decker, J. C. | 3rd cover |
| Devoe, F. W., & Reynolds Co., C. T. | 3rd cover |
| Eberly & Orris Mfg. Co. | 3rd cover |
| Eccles Co., Richard | 17 |
| Enterprise Foundry, The | 13 |
| Gerhab, Jacob | 12 |
| Gifford & Son, John A. | 13 |
| Goodrich Co., B. F., The | 5 |
| Goshen Eyelet Co. | 14 |
| Gramm Motor Car Co., The | 11 |
| Higgin Mfg. Co. | 12 |
| Hoopes Bro. & Darlington, Inc. | 2nd cover |
| Indiana Forging Co. | 12 |
| Jones & Co., Phineas | 4-6 |
| Keystone Paint & Filler Co. | 4 |
| Kilvington, S. W. | 18 |
| Koller Co., J. B. | 3rd cover |
| Masury & Son, John W. | 2 |
| Mayo Radiator Co. | 17 |
| McKinnon Dash Co. | 4th cover |
| Mercer, Geo. J. | 18 |
| Moller & Schuman Co. | 6 |
| Murphy Varnish Co. | 4 |
| Nelson Co., A. T. A. | 2 |
| New Wapakoneta Wheel Co., The | 13 |
| Ochsner & Sons Co., A. | 12 |
| Payne Co., E. Scott | 11 |
| Porter, H. K. | 17 |
| Reilly, John, Inc. | 2 |
| Russell, Burdsall & Ward Bolt and Nut Co. | 3rd cover |
| Schubert Bros. Gear Co. | 17 |
| Spring Perch Co. | 11 |
| Standard Automatic Mfg. Co. | 1 |
| Standard Oil Cloth Co. | 18 |
| Standard Wheel Co. | 17 |
| Steel Socket Shaft End Co. | 13 |
| Timken Roller Bearing Co. | 11 |
| Uebelmesser Co., Charles R. | 14 |
| Valentine & Company | 6 |
| West Tire Setter Co. | 6 |
| Wiggers Furniture Co. | 4th cover |
| Wilcox Mfg. Co., D. | 15 |
| Willey Co., C. A. | 4 |
| Woodman, Joel H. | 14 |

Please mention "The Hub" when you write.

VEHICLE WHEELS OF REAL WORTH

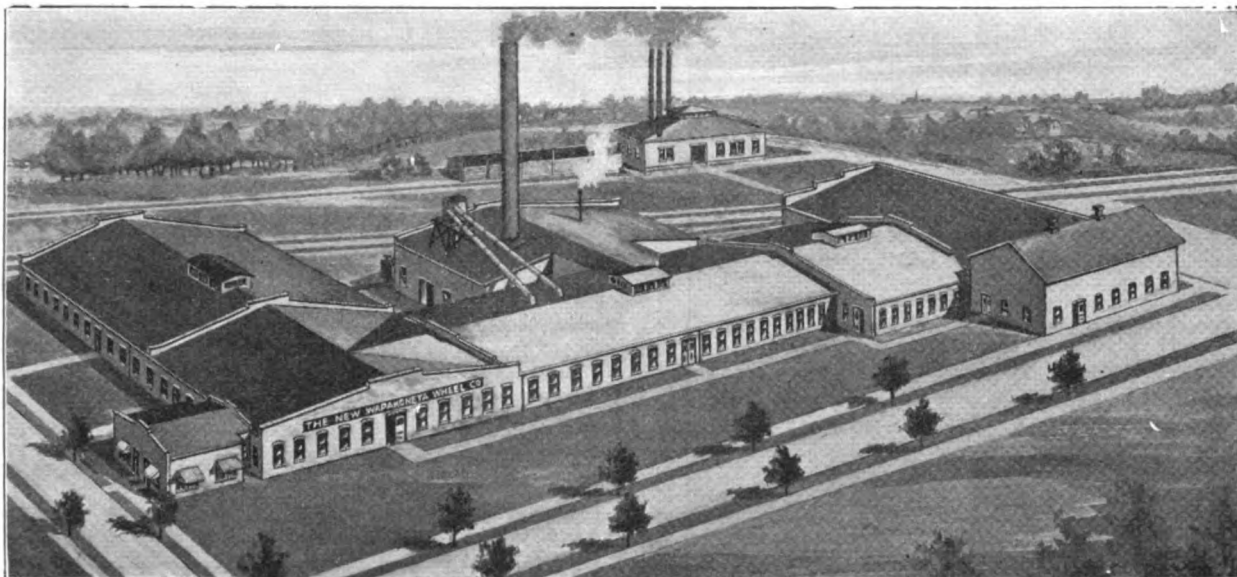

We manufacture Vehicle Wheels of All Kinds; Light and Heavy. Sarven, Warner, Compressed Band and Wood Hub. Send for our Price List.

THE NEW WAPAKONETA WHEEL COMPANY WAPAKONETA, OHIO

Burlington Rubber Tire Machine



Our big No. 4 is the only machine made that will apply all kinds of solid and cushion rubber tires both internal and outside wires and close the joint on the same machine. One man can operate the machine easily without help. Put an end to your troubles in applying tires by investing in this machine. Write for descriptive circulars and price.

THE ENTERPRISE FOUNDRY
HARVEY, ILL., U. S. A.



Splice Joint Shaft and Pole Ends Give Perfect Satisfaction

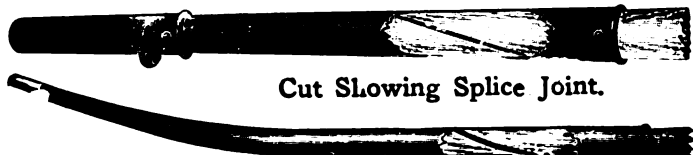

Cut Showing Splice Joint.

THE SPLICE JOINT where the woods meet adds great strength, guarantees them against breaking where repaired, and prevents working loose and rattling. No shaft end without this construction can possibly give reliable service. No other shaft end than the Splice Joint can have these advantages, as we are the original manufacturers, and these features are fully covered by our patents. Insist on having the original Double Tube Splice Joint Steel Socket Shaft Ends and you get the best.

Handled by All Leading Jobbers.

STEEL SOCKET SHAFT END CO. CLEVELAND, O.

Please mention "The Hub" when you write.



Painters and Decorators Save Time, Labor and Money, using the

Uebelmesser Striping and Stencil Wheel

With this simple, clean and rapid-action tool the most ordinary decorator can do the finest striping and stencil work and produce a bigger day's work with less labor than by the old fashioned method. Complete directions are furnished with each tool. They are as simple as the tool itself.

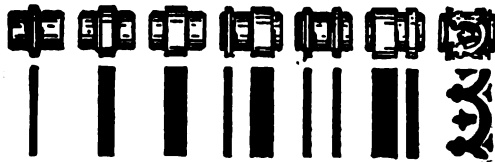

Just a few of the many designs that can be produced with the Uebelmesser Painters' and Decorators' Tool. (The designs shown above are reduced in size)

Complete Outfit consisting of Machine, 10 Plain and 10 Ornamental Wheels, only .. **\$5.50**
LIBERAL DISCOUNT TO THE TRADE

Manufactured by

Charles R. Uebelmesser Company
Bayside, New York, N. Y.

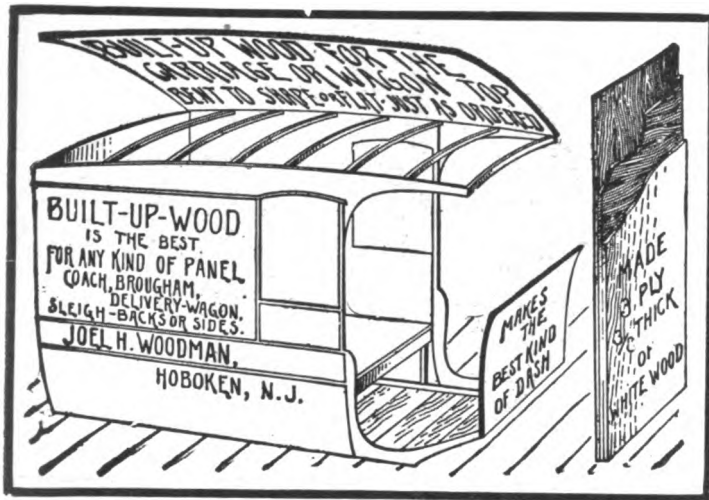

Goshen Eyelet Co.

Manufacturers of

Carriage Top Trimmings

GOSHEN, INDIANA

Advertisements Classified

The following list includes advertisers in THE HUB. Each advertiser is entitled to name under one heady only. An extra charge for name under more than one heading.

- Axles**
 - American Ball Bearing Co., Cleveland, Ohio.
 - Keagy & Lear Machine Co., Coshocton, Ohio.
 - Timken Roller Bearing Co., Canton, Ohio.
- Automobile Radiators**
 - Mayo Radiator Co., New Haven, Conn.
- Bodies, Seats, Etc.**
 - Kilvington, S. W., Wilmington, Del.
 - Wiggers Furniture Co., The, Cincinnati, Ohio.
 - Woodman, Joel H., Hoboken, New Jersey.
- Bolts and Nuts**
 - Columbus Bolt Works, Columbus, Ohio.
 - Russell, Burdsall & Ward Bolt and Nut Co., Port Chester, N. Y.
- Carriage Forgings.**
 - Columbus Bolt Works, Columbus, Ohio.
 - Eccles Co., Richard, Auburn, N. Y.
 - Indiana Forging Co., Indianapolis, Ind.
- Carriage Hardware.**
 - Gifford & Son, John A., New York.
 - Ochsner & Sons Co., A., New Haven, Conn.
 - Payne Co., E. Scott, Baltimore, Md.
- Carriage Goods**
 - Gifford & Son, John A., New York.
 - Higgin Mfg. Co., Newport, Ky.
- Dashes, Fenders, Rails, Etc.**
 - Bennett Mfg. Co., Alden, N.Y.
 - McKinnon Dash Co., Buffalo, N. Y.
- Fifth Wheels**
 - American Roller Bearing Fifth Wheel Co., Brooklyn, N. Y.
 - Wilcox Mfg. Co., D., Mechanicsburg, Pa.
- Finished Vehicles**
 - Balley & Co., Inc., S.R., Amesbury, Mass
- Gear Irons**
 - Wilcox Mfg. Co., D., Mechanicsburg, Pa.
- Gear Woods**
 - Andrew Kimble, Zanesville, O.
- Lamps**
 - Gifford & Son, John A., New York.
- Leather**
 - Nelson, A. T. A., Co., Cincinnati, Ohio.
 - Relly, John, Inc., Newark, N.J.
- Lubricating Device**
 - Aden Mfg. Co., Dansville, Va.
- Motor Trucks**
 - Gramm Motor Car Co., The Lima, Ohio.
- Machinery and Tools**
 - Bokop, Webb & Palm, Defiance, Ohio.
 - Enterprise Foundry, The, Harvey, Ill.
 - Porter, H. K., Everett, Mass.
 - Standard Automatic Mfg. Co., New York.
 - West Tire Setter Co., Rochester, N. Y.
- Miscellaneous**
 - Goshen Eyelet Co., Goshen, Ind.
 - Standard Oil Cloth Co., New York.
 - Uebelmesser Co., Charles R. Bayside, New York.
- Rubber Tires**
 - Consolidated Rubber Tire Co., New York City.
 - Goodrich Co., B. F., Akron, O.
- Rims**
 - United Rim Co., Akron, Ohio.
- Shaft Couplings and Anti-Rattlers**
 - Eccles Co., Richard, Auburn, N. Y.
 - Metal Stamping Co., New York City.
 - Steel Socket Shaft End Co., Cleveland, Ohio.
- Spark Plugs**
 - Ball Multi-Spark Plug Co., Minneapolis, Minn.
- Springs and Gears.**
 - Keystone Spring Works, Inc., Philadelphia, Pa.
 - Spring Perch Co., Bridgeport, Conn.
- Varnishes, Paints and Japans**
 - The Ault & Wiborg Co., Cincinnati, Ohio.
 - Devoe, F. W., and C. T. Reynolds Co., New York City.
 - Masury & Son, John W., New York and Chicago.
 - Moller & Schumann, Brooklyn, N. Y.
 - Murphy Varnish Co., Newark, N. J.
 - Valentine & Co., New York, Chicago, Boston, Paris.
 - Wiley Co., C. A., Hunter's Pt., New York City.
- Wheels**
 - Crane & MacMahon, New York
 - Gifford & Son, John A., New York.
 - Hoopes Bro. & Darlington, West Chester, Pa.
 - Jones & Co., Phineas, Newark, N. J.
 - New Wapakoneta Wheel Co., Wapakoneta, Ohio.
 - Standard Wheel Co., Terre Haute, Ind.
 - Wheel Stock, Bent Wood, Etc. Crane & MacMahon, New York

HEADQUARTERS FOR SPECIAL FINE GEAR IRONS [Dropped Forged] CARRIAGE HARDWARE

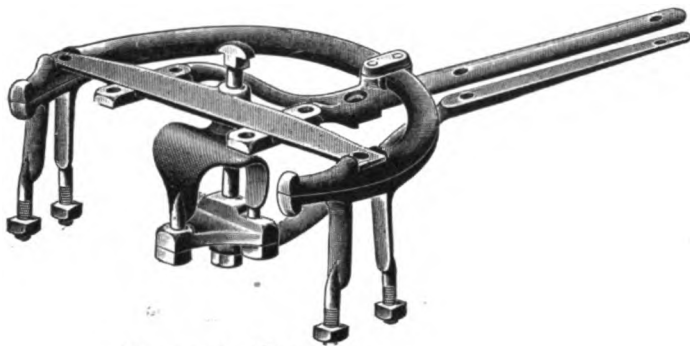

No. 1908—Gear Iron

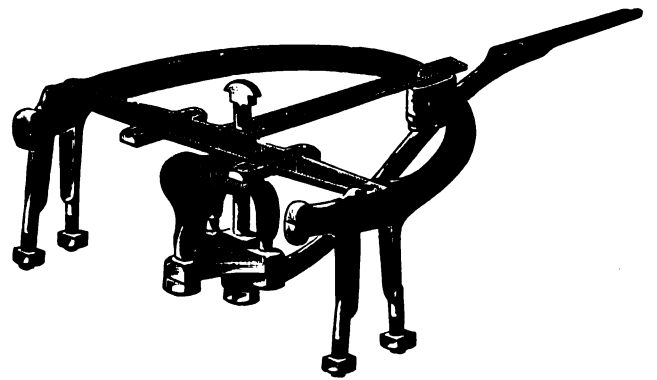

No. 2000—Gear Iron

WILCOX'S Mechanical 3 Prong King Bolt

Double Locked in Head Block
Plate and King Bolt Yoke. No
Strain on Bolt. No Turn on
Nut. Guaranteed.

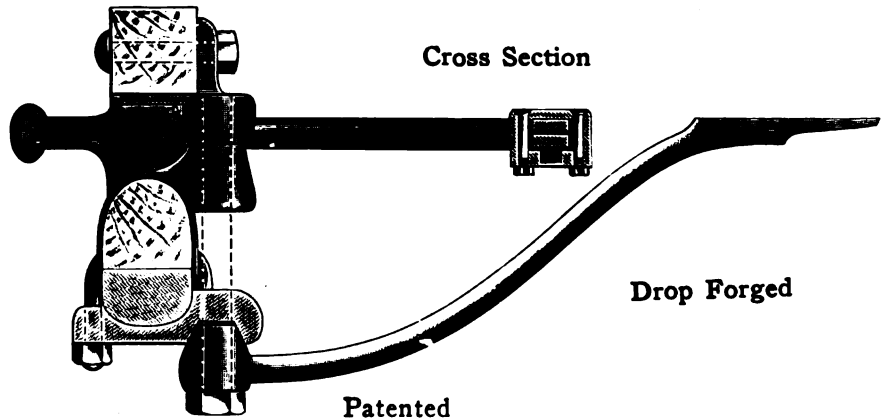

Cross Section

Drop Forged

Patented

S
U
R
E
S
A
F
E

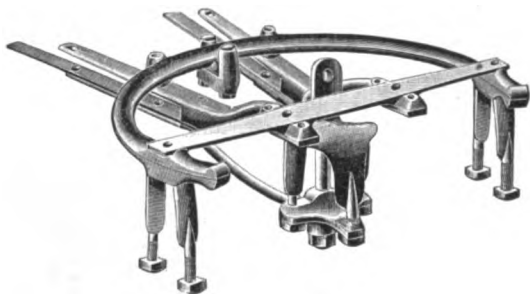

No. 1905—Gear Iron

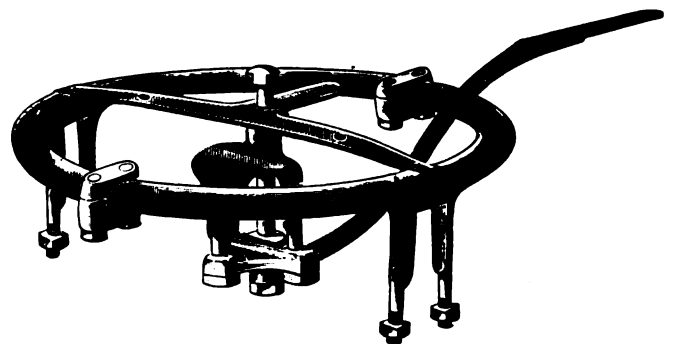

No. 1909—Concord.

Forget your trouble and decide at once to use WILCOX DROP FORGED IRONS. Write us for pleasure

The D. Wilcox Mfg. Co. Mechanicsburg Pa.

Please mention "The Hub" when you write.

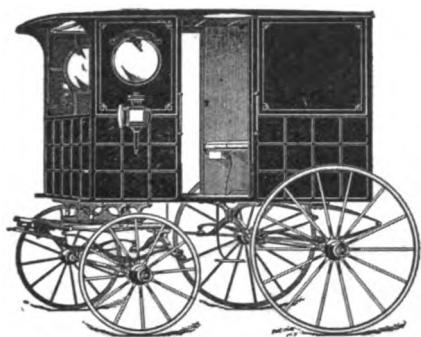

No. 112.—Milk Wagon.

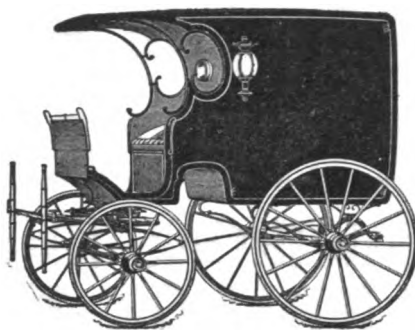

No. 111.—Altman Wagon.

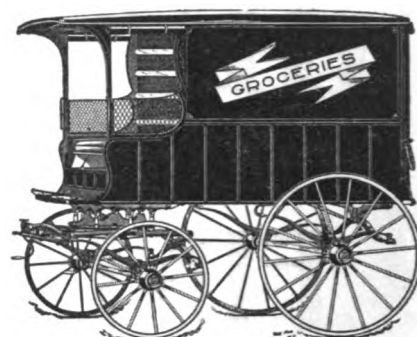

No. 113.—Grocery Wagon.

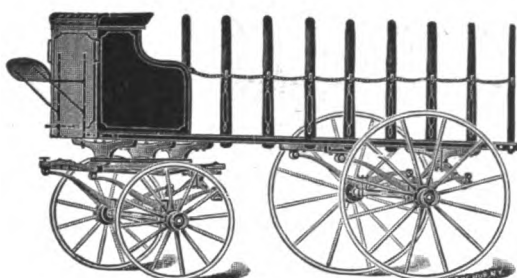

No. 122.—Flour Truck.



No. 116.—Milk Wagon.

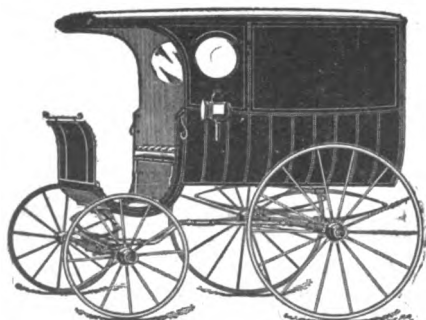

No. 114.—Delivery Wagon.

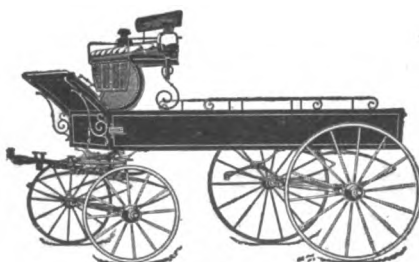

No. 124.—Delivery Wagon.

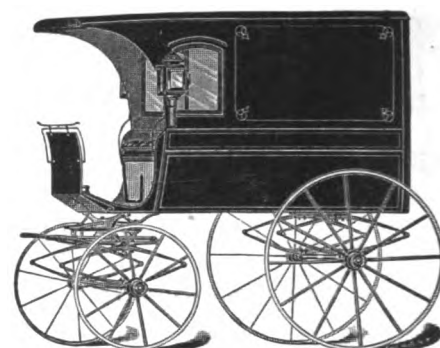

No. 115.—Delivery Wagon.

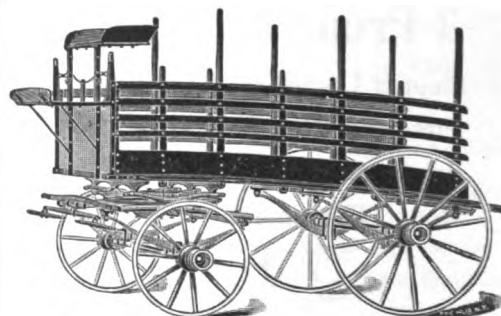

No. 117.—Merchandise Truck.

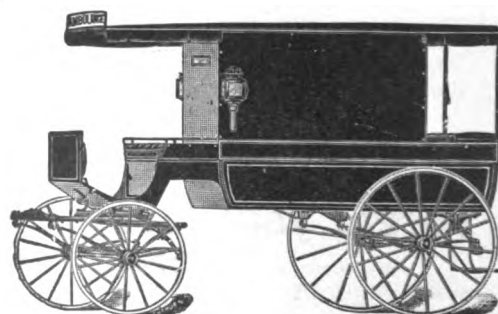

No. 118.—Ambulance.

Electrotypes

of the vehicles presented on this page will be forwarded on receipt of

75 cts.

for each cut, to any address. Postage prepaid.

Catalogue

containing nearly 200 illustrations of carriages, wagons, sleighs, and miscellaneous cuts will be sent upon application.

Trade News Publishing Co.
24-26 MURRAY ST.
NEW YORK

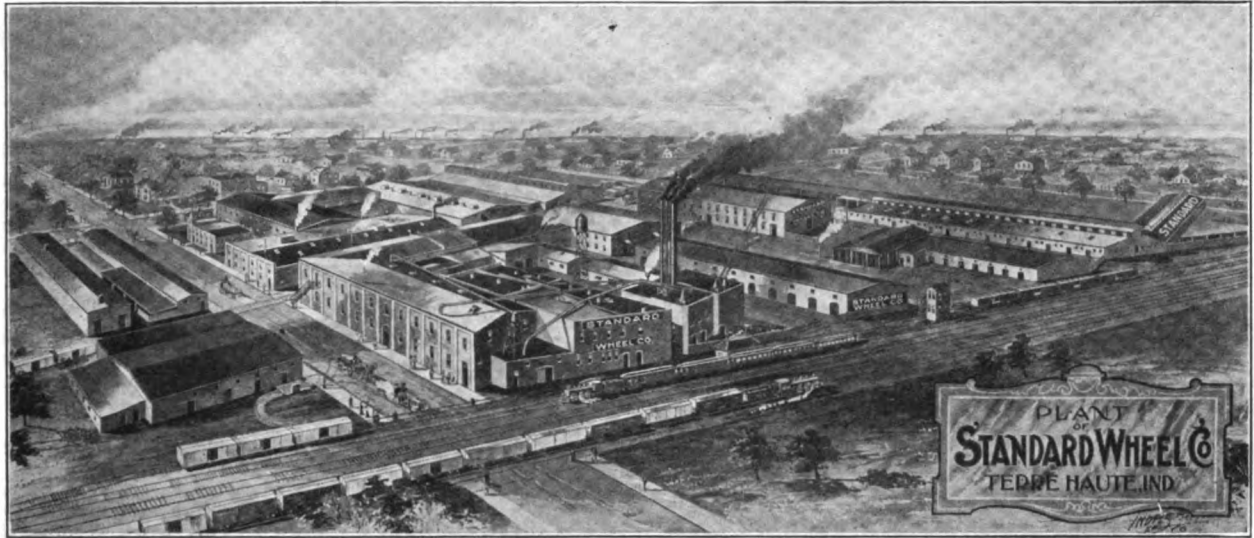

VEHICLE WHEELS AND WHEEL MATERIAL

Three Separate Departments [Light Carriage and Buggy Wheels
Heavy Express Wagon and Truck Wheels
Automobile Wheels

OUR GRADES ARE UNEXCELLED

WRITE FOR LIST.

Terre Haute, Ind. **STANDARD WHEEL CO.** Terre Haute, Ind

Richard Eccles Co., Auburn N. Y.

Manufacturers of

Forgings: Carriage, Wagon, Automobile, Special

Send for Catalogue.



VEHICLES AND GEARS IN THE WHITE



PREMIER SIDE SPRING GEAR

We manufacture a full line of Carriage and Wagon bodies in the white; also Limousine, Taxicab, Touring Car and Roadster Bodies for automobiles in metal. Fifty styles of gears for Carriages and Wagons; also seats, trimmings and tops of all kinds.

Write to us for particulars.

Schubert Bros. Gear Company

ONEIDA, NEW YORK.



MAYO RADIATORS

have done their part in making the splendid reputations of America's best known cars.

Can any maker afford to jeopardize his reputation and nullify his good work in other directions for the sake of a few dollars "saved" in the purchasing department?

MAYO RADIATOR CO.

New Haven,

Connecticut

F. W. DEVOE & C. T. RAYNOLDS CO.

101 and 103 FULTON STREET, NEW YORK

Manufacturers of

F. W. DEVOE & CO'S {
 COACH COLORS
 VARNISHES
 BRUSHES
 SPECIALTIES

C. T. RAYNOLDS & CO'S {
 COACH COLORS
 VARNISHES
 BRUSHES
 SPECIALTIES

FOR PAINTERS, ARTISTS AND DECORATORS

All the brands and specialties of F. W. Devoe & Co. and C. T. Raynolds & Co. will be maintained separately as heretofore.

AUTOMOBILE, CARRIAGE and HARNESS SPECIALTIES

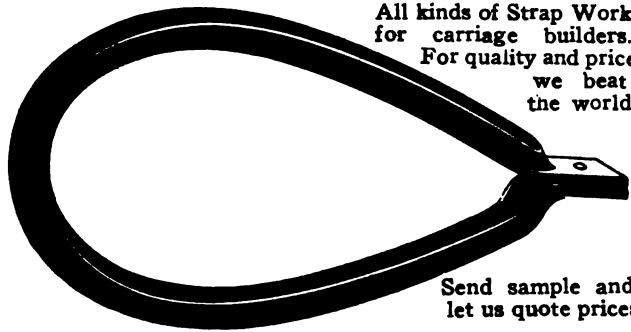

All kinds of Strap Work for carriage builders. For quality and price we beat the world.

Send sample and let us quote prices

J. C. DECKER :

Montgomery, Pa.

J. B. KOLLER & COMPANY

Manufacturers of

FINISHED SPOKES

All Sizes for

SARVAN, WARNER, SHELL BAND AND WOOD HUB WHEELS.

HICKORY and OAK BENT RIMS

Mechanicsburg,

Pennsylvania

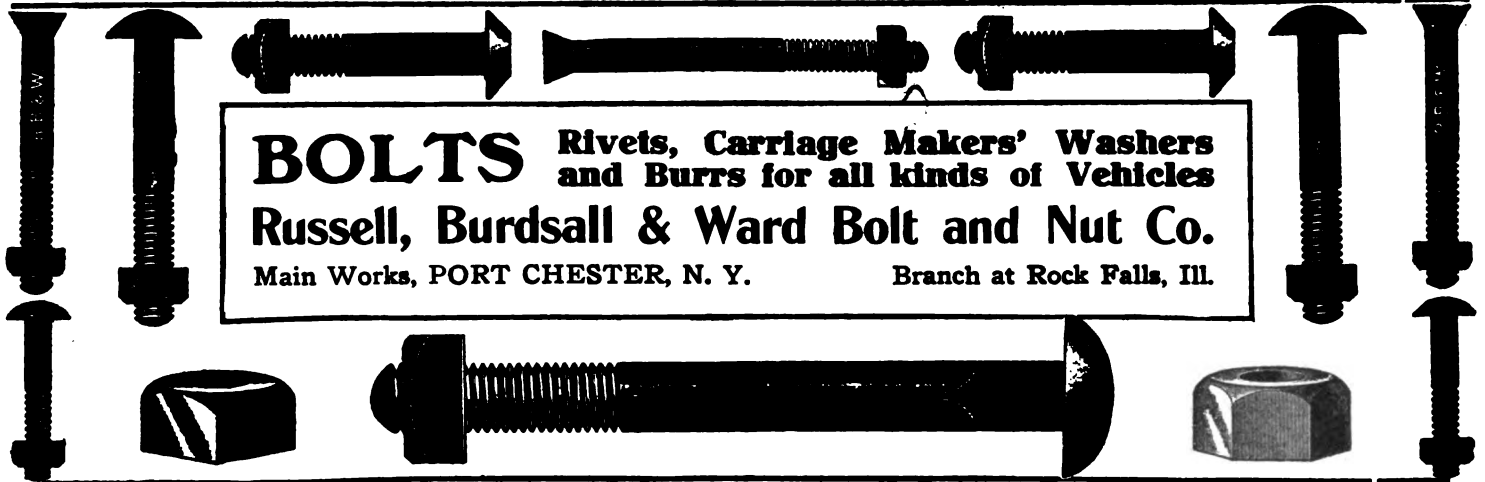

BOLTS Rivets, Carriage Makers' Washers and Burrs for all kinds of Vehicles

Russell, Burdsall & Ward Bolt and Nut Co.

Main Works, PORT CHESTER, N. Y.

Branch at Rock Falls, Ill.

Time Has Told the Story!

Service and satisfaction always follow our rolling stock

WHEELS

ALL KINDS—BEST QUALITY

Also RIMS and SPOKES

The Eberly & Orris Mfg. Co.

MECHANICSBURG, PA.

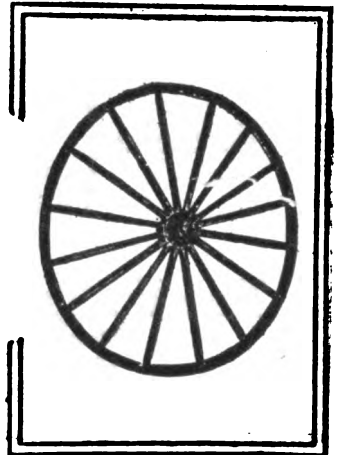
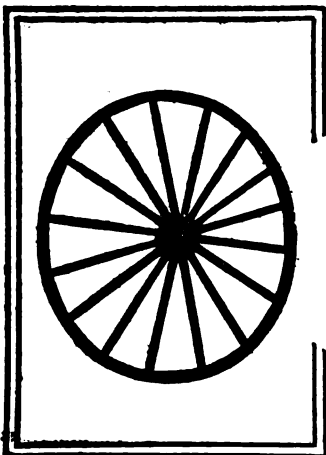

McKINNON DASH COMPANY

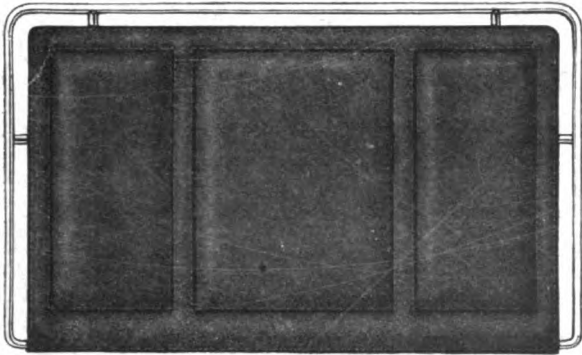

No. 172-N. With Nickel Rail.

BUFFALO, N. Y.

**TROY, OHIO,
CINCINNATI, OHIO.**

**ST. CATHARINES,
ONTARIO.**

A dash protected by a rail on top and ends will outlast any other style.

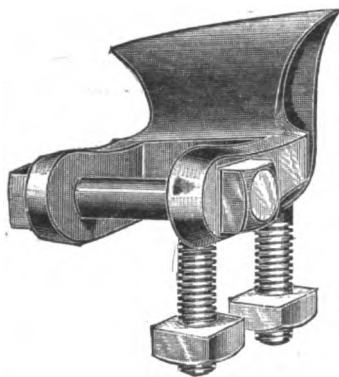

Skewed Shaft Couplings

**Regular or Oval Patterns
For High Arched Axles**

Furnished in rights and lefts for any height of arch. Oval Axle Clips $\frac{5}{8}$ or $\frac{3}{4}$ width to match Oval Couplings. Bolts, Clips, Couplings, Carriage Hardware and Special Forgings

Catalogue "H" and Prices on Application.

COLUMBUS BOLT WORKS, Columbus, O.

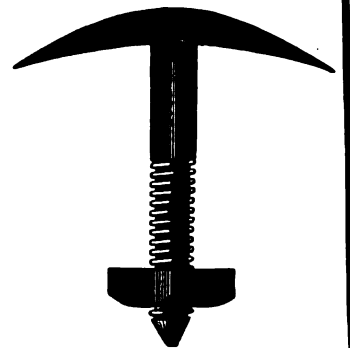

A. H. WIGGERS
Pres. and Mgr.

H. H. WIGGERS
Sec'y and Treas.

E. S. WIGGERS
Vice-Pres.

WIGGERS' BODIES

Automobile - Carriage

MERIT CONSIDERATION



Just One of Many Styles.

Because { **THEY HAVE** { Style Quality Symmetrical Outlines
 { **AND ARE** { Well Seasoned Made to Wear Priced Right

Address

The Wiggers Furniture Co.

Manufacturers of Carriage and Auto Bodies and Seats

1417 to 1423 Plum St.

Cincinnati, Ohio

THE BARBOUR (NEAR RUBBER) STEEL TIRES

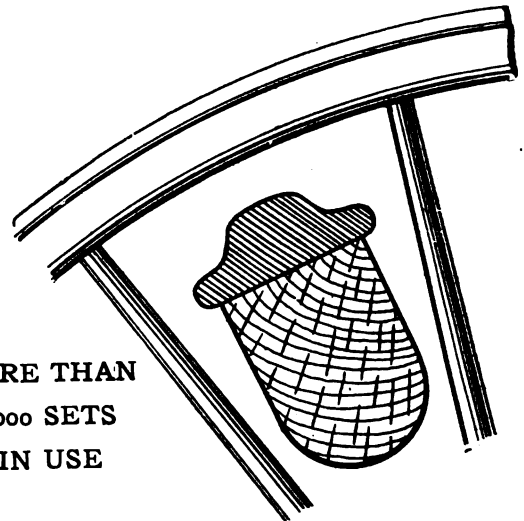

**MORE THAN
10,000 SETS
IN USE**

They wear fifty per cent longer than the flat, and add from fifty to one hundred per cent to the life of a wheel. Having no suction are of lighter draft in mud. Ride easier than other tires. Strike obstructions glancing instead of solid blows. Have more resistance to expansion and elongation. Cast loose stones aside instead of passing over them. Strengthens felloe between spokes. Add greatly to the appearance of a vehicle. Are moderate in price. Sold by leading jobbers. For further information write

BARBOUR STEEL TIRE CO.
TERRE HAUTE, IND.

To renew the charge, book must be brought to the desk.

DATE DUE

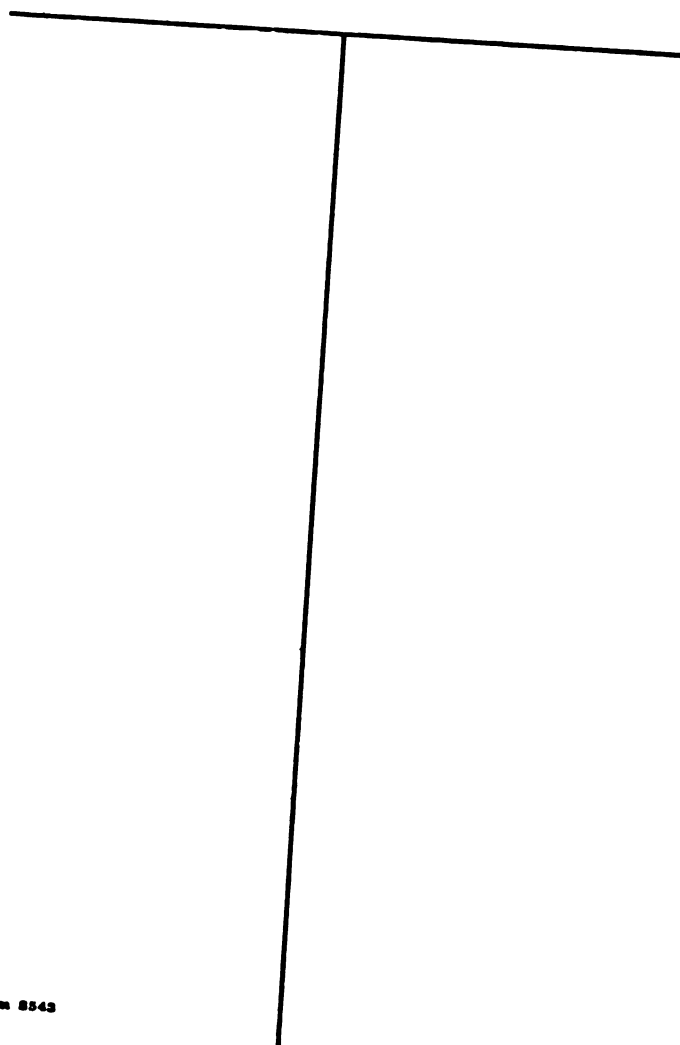

Form 8543